

R2300

# REED INSTRUMENTS

## Infrared Thermometer



## Instruction Manual

**REED Instruments**

1-877-849-2127 | info@reedinstruments.com | www.reedinstruments.com

# Table of Contents

Introduction .....	3
Product Quality.....	3
Safety .....	3
Features.....	4
Specifications.....	4-5
Instrument Description .....	5
Display Description .....	6
Distance & Spot Size.....	7
Operating Instructions.....	8-10
<i>Power ON and OFF</i> .....	8
<i>Turn Laser Indicator ON and OFF</i> .....	8
<i>Turn Display Backlight ON and OFF</i> .....	8
<i>Display Maximum and Minimum Temperatures During Measurement</i> ...	8
<i>Data Hold Measurement</i> .....	8
<i>Entering Setting Mode</i> .....	9
<i>Adjusting Emissivity</i> .....	9
<i>Switching the Unit of Measure (°F/°C)</i> .....	9
<i>Turning the Alarm Chime ON or OFF</i> .....	9
<i>Setting the High Temperature Alarm</i> .....	10
<i>Setting the Low Temperature Alarm</i> .....	10
Appendix: Emissivity Chart .....	11-12
Fault Diagnostics.....	13
Battery Replacement.....	13
Applications.....	14
Product Care .....	14
Product Warranty .....	14
Product Disposal and Recycling .....	15
Product Support.....	15

## Introduction

Thank you for purchasing your REED R2300 Infrared Thermometer. Please read the following instructions carefully before using your instrument. By following the steps outlined in this manual your meter will provide years of reliable service.

## Product Quality

This product has been manufactured in an ISO9001 facility and has been calibrated during the manufacturing process to meet stated product specifications. If a certificate of calibration is required please contact the nearest authorized REED distributor or authorized Service Center. Please note an additional fee for this service will apply.

## Safety

- Never attempt to repair or modify your instrument. Dismantling your product, other than for the purpose of replacing batteries, may cause damage that will not be covered under the manufacturer's warranty. Servicing should only be provided by an authorized service center.
- Use extreme caution when the laser beam is turned on.
- Do not let the beam enter your eye, another person's eye or the eye of an animal.
- Be careful not to point the beam off a reflective surface and strike your eye.
- Do not allow the laser light beam to impinge on any gas which can explode.



## Features

- Built-in laser pointer identifies target area
- User selectable °F or °C
- 12:1 distance to spot size ratio
- Digitally adjustable emissivity
- Max and Min readings
- Backlit display
- High and low alarms
- Low battery indication and auto shut off

## Specifications

Temperature Range:	-25.6 to 752°F (-32 to 400°C)
Accuracy:	±4°F (2°C) or ±2% rdg.
Resolution:	0.1°F (0.1°C)
Optical Resolution (D:S):	12:1
Spectral Response:	8 to 14µm
Emissivity:	0.1 to 1.0 (Adjustable)
Response Time:	500ms
Backlit Display:	Yes
Display Hold:	Yes
High/Low Alarms:	Yes
Alarm Indicators:	Yes (Beeping)
Max/Min:	Yes
F/C Switchable:	Yes
Laser Type:	Class II
Low Battery Indicator:	Yes
Power Supply:	9V battery
Product Certifications:	CE, ETL, RoHS
Battery Life:	Approx. 10 hours (with continuous use, backlight on)

*continued...*

**REED Instruments**

1-877-849-2127 | info@reedinstruments.com | www.reedinstruments.com

Operating Temperature:	32 to 104°F (0 to 40°C)
Storage Temperature:	-4 to 140°F (-20 to 60°C)
Operating Humidity Range:	<90%
Maximum Operating Altitude:	6561' (2000m)
Maximum Storage Altitude:	39370' (12000m)
Dimensions:	6.0 x 4.3 x 1.6" (153 x 108 x 40mm)
Weight:	6.5oz (185g)



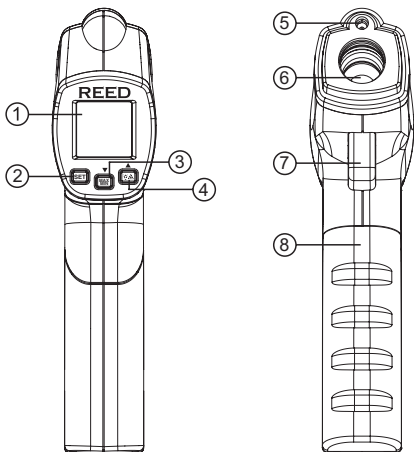

## Instrument Description

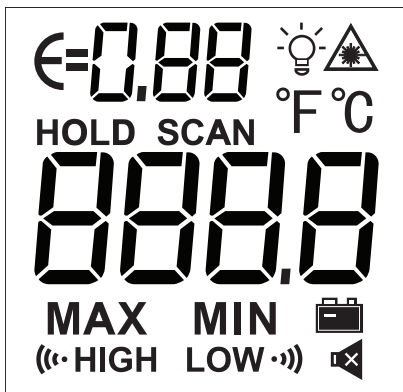

- |   |                       |
|---|-----------------------|
| 1. LCD Display                                | 5. Laser Pointer Beam |
| 2. Set Button                                 | 6. IR Sensor          |
| 3. MAX/MIN/DOWN<br>Arrow Button               | 7. Trigger            |
| 4. Backlight/Laser Toggle/<br>UP Arrow Button | 8. Battery Cover      |

## Display Description



	Emissivity
	Laser ON
<b>SCAN</b>	Temperature Measurement Active
<b>HOLD</b>	Measurement Data Hold
<b>MAX MIN</b>	Maximum or Minimum Value
	Low Battery
	Backlight Indicator
<b>°F °C</b>	Unit of Measurement
<b>HIGH LOW</b> 	High and Low Limit Alarm
<b>((( HIGH LOW )))</b>	Alarm On/Off

## Distance & Spot Size

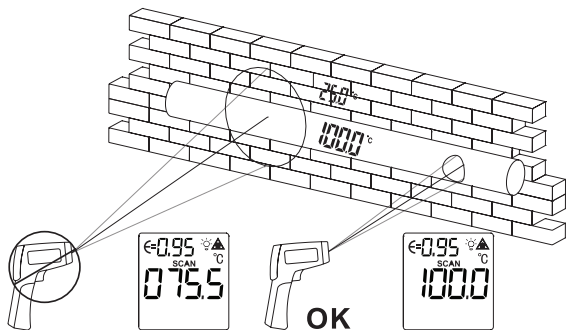
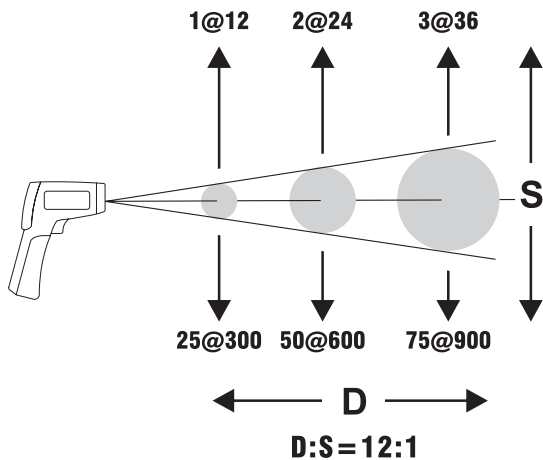

**REED Instruments**





1-877-849-2127 | [info@reedinstruments.com](mailto:info@reedinstruments.com) | [www.reedinstruments.com](http://www.reedinstruments.com)

# Operating Instructions





## Power ON and OFF

1. Gently pull the trigger to turn the thermometer on. The LCD display and white backlight will turn on.
2. The thermometer will automatically shut off after 9 seconds of inactivity.

## Turn Laser Indicator ON and OFF

To turn the laser on or off, press and hold the  button for 3 seconds. The  icon will appear on the display indicating the laser is on. Press and hold the  button again for 3 seconds and the  icon will disappear on the display indicating the laser is now off.

## Turn Display Backlight ON and OFF

To turn the display backlight on or off, press the  button. The  icon will disappear on the display indicating the backlight is now off. Press the  button again and the  icon will reappear on the display and the backlight will turn on.

## Display Maximum and Minimum Temperatures During Measurement

Press the **MAX MIN** button to toggle between the maximum and minimum temperature measurement modes. When the trigger is pulled in **MAX** mode, the maximum temperature measurement will show on the display. When the trigger is pulled in **MIN** mode, the minimum temperature measurement will show on the display. To resume normal operation, press and hold the **MAX MIN** button for 3 seconds.

## Data Hold Measurement

Pull and hold the trigger after aiming at the target. The **SCAN** icon will flash, indicating that the target temperature is being measured. When the trigger is released, the **SCAN** icon will disappear and the **HOLD** icon will appear indicating that measurement has stopped and the last measured temperature will remain on-screen until another measurement is taken.

*continued...*



## Entering Setting Mode

Press the trigger and then the **SET** button to enter the setting mode. In this mode, a user can choose the desired setting for emissivity, unit of measure, alarm chime toggle and High and Low Alarm value adjustment. Once in the setting mode, press the **SET** button to toggle through each mode. The corresponding icon will flash indicating an adjustment can be made for the selected parameter. Once the desired adjustments have been made, press and hold the **SET** button for 3 seconds to resume normal operation.

## Adjusting Emissivity

When in Setting Mode, the  $\epsilon$  will flash, indicating the value can be adjusted. Press  $\blacktriangle$  to increase the emissivity value by 0.01. Press and hold the  $\blacktriangle$  for quicker value adjustment. Press  $\blacktriangledown$  to decrease the emissivity value by 0.01. Press and hold the  $\blacktriangledown$  for quicker value adjustment. Once the desired adjustments have been made, press and hold the **SET** button for 3 seconds to resume normal operation.

## Switching the Unit of Measure (°F/°C)

When in Setting Mode, press the **SET** button until the °F or °C flash, indicating the value can be modified. Press  $\blacktriangle$  or  $\blacktriangledown$  to toggle between Fahrenheit and Celsius. Once the desired unit of measure has been selected, press and hold the **SET** button for 3 seconds to save the selection and resume normal operation.

## Turning the Alarm Chime ON or OFF

When in Setting Mode, press the **SET** button until the  $\text{Hx}$  flashes, indicating the high/low alarm chime can be adjusted. Press  $\blacktriangle$  or  $\blacktriangledown$  to turn the alarm chime ON or OFF. When the chime is set to ON the (H HIGH LOW ) will be displayed. When the chime is set to OFF the HIGH LOW will be displayed. Please note that when the chime is off, the MAX and MIN alarm icons will still appear on screen when an alarm is triggered. Once the desired selection has been made, press and hold the **SET** button for 3 seconds to save the selection and resume normal operation.

*continued...*

## *Setting the High Temperature Alarm*

When in Setting Mode, press the **SET** button until the HIGH icon flashes, indicating the value can be modified. Press ▲ to increase the temperature value. Press and hold the ▲ for quicker value adjustment. Press ▼ to decrease the temperature value. Press and hold the ▼ for quicker value adjustment. Once the desired adjustments have been made, press and hold the **SET** button for 3 seconds to save the selected high alarm temperature and resume normal operation.

## *Setting the Low Temperature Alarm*

When in Setting Mode, press the **SET** button until the LOW icon flashes, indicating the value can be modified. Press ▲ to increase the temperature value. Press and hold the ▲ for quicker value adjustment. Press ▼ to decrease the temperature value. Press and hold the ▼ for quicker value adjustment. Once the desired adjustments have been made, press and hold the **SET** button for 3 seconds to save the selected low alarm temperature and resume normal operation.

## Appendix: Emissivity Chart

Emissivity is a term used to describe the energy-emitting characteristics of materials. Most (90% of typical applications) organic materials and painted or oxidized surfaces have an emissivity of 0.95. Inaccurate readings will result from measuring shiny or polished metal surfaces. To compensate, cover the surface to be measured with masking tape or flat black paint. Allow time for the tape to reach the same temperature as the material underneath it. Measure the temperature of the tape or painted surface.

Measured Surfaces	Emissivity
<b>Metal</b>	
Aluminum: Oxidization	0.2-0.4
A3003 Alloy: Oxidization, Rough	0.3, 0.1-0.3
Brass: Burnishing, Oxidization	0.3, 0.5
Copper: Oxidization, Electric Terminal Board	0.4-0.8, 0.6
Hastelloy: Alloy	0.3-0.8
Inconel: Oxidization, Sand-Blasting, Electro Burnishing	0.7-0.95, 0.3-0.6, 0.15
Iron: Oxidization, Rusting	0.5-0.9, 0.5-0.7
Iron (Casting): Oxidization, Non-Oxidization, Casting	0.6-0.95, 0.2, 0.2-0.3
Iron (Forging): Passivation	0.9
Lead: Rough, Oxidization	0.4, 0.2-0.6
Molybdenum: Oxidization	0.2-0.6
Nickel: Oxidization	0.2-0.5
Platinum: Black	0.9

*continued...*

Measured Surfaces	Emissivity
Steel: Cold Rolling, Steel Plate-Burnishing, Steel Plate Rubbing	0.7-0.9, 0.4-0.6, 0.1
Zinc: Oxidization	0.1
<b>Non-Metal</b>	
Asbestos	0.95
Asphalt	0.95
Basalt	0.7
Carbon: Non-Oxidization, Graphite, Silicone Carbide	0.8-0.9, 0.7-0.8, 0.9
Ceramics	0.95
Clay	0.95
Concrete	0.95
Cloth	0.9
Glass: Convex, Smooth, Lead-Boron	0.76-0.8, 0.92-0.94, 0.78-0.82
Plates	0.96
Stone Products	0.93
Plaster	0.8-0.95
Ice	0.98
Limestone	0.98
Paper	0.95
Plastics	0.95
Water	0.93
Soil	0.9-0.98
Wood	0.9-0.95

## Fault Diagnostics

Symptom	Problem	Action
OL (on the display screen)	Target temperature exceeds instrument temperature range	Select target within temperature range
-OL (on the display screen)	Target temperature lower than range	Select target within temperature range
Battery indication icon flashes	Low battery	Replace battery
Blank display screen when trigger is pulled	Low battery	Replace battery
Laser fails to work	1. Low battery  2. Environmental condition exceeding instrument's maximum temperature of 40°C (104°F)	1. Replace battery  2. Only operate under stated environmental conditions

## Battery Replacement

1. The battery should be replaced when  is displayed.
2. Remove the battery cover.
3. Replace the 9V battery.
4. Close the battery cover.

## Applications

- Verify mechanical (bearings, motors) or electrical (circuit breaker boxes) equipment
- Calibration and control of heater and oven temperatures
- Monitoring materials in processes involving heating and/or cooling
- Quality control monitoring
- Research and development applications
- Automotive diagnostics
- Conduct HVAC energy audits

## Product Care

To keep your instrument in good working order we recommend the following:

- Store your product in a clean, dry place.
- Change the battery as needed.
- If your instrument isn't being used for a period of one month or longer please remove the battery.
- Clean your product and accessories with biodegradable cleaner. Do not spray the cleaner directly on the instrument. Use on external parts only.

## Product Warranty

REED Instruments guarantees this instrument to be free of defects in material or workmanship for a period of one (1) year from date of shipment. During the warranty period, REED Instruments will repair or replace, at no charge, products or parts of a product that proves to be defective because of improper material or workmanship, under normal use and maintenance. REED Instruments total liability is limited to repair or replacement of the product. REED Instruments shall not be liable for damages to goods, property, or persons due to improper use or through attempts to utilize the instrument under conditions which exceed the designed capabilities. In order to begin the warranty service process, please contact us by email at 1-877-849-2127 or [info@reedinstruments.com](mailto:info@reedinstruments.com) to discuss the claim and determine the appropriate steps to process the warranty.

**REED Instruments**

1-877-849-2127 | [info@reedinstruments.com](mailto:info@reedinstruments.com) | [www.reedinstruments.com](http://www.reedinstruments.com)

## Product Disposal and Recycling



Please follow local laws and regulations when disposing or recycling your instrument. Your product contains electronic components and must be disposed of separately from standard waste products.

## Product Support

If you have any questions on your product, please contact your authorized REED distributor or REED Instruments Customer Service by phone at 1-877-849-2127 or by email at [info@reedinstruments.com](mailto:info@reedinstruments.com).

Please visit [www.REEDINSTRUMENTS.com](http://www.REEDINSTRUMENTS.com) for the most up-to-date manuals, datasheets, product guides and software.

*Product specifications subject to change without notice.*

*All rights reserved. Any unauthorized copying or reproduction of this manual is strictly prohibited without prior written permission from REED Instruments.*

# REED INSTRUMENTS

## TEST & MEASURE WITH CONFIDENCE



**CHECK OUT OUR LATEST PRODUCTS!**

**REED Instruments**

1-877-849-2127 | info@reedinstruments.com | www.reedinstruments.com