

Operator's Guide

PowerScoutTM 3037 Power Meter

Includes:

ViewPointTM Software



January 14, 2016

Operator's Guide: PowerScout™ Power Meters ©2016 DENT Instruments, Inc. All rights reserved.
This manual may not be reproduced or distributed without written permission from DENT Instruments.
PowerScout™, ViewPoint™, and PhaseChek™ are trademarks of DENT Instruments, Inc. Windows®,
Windows® Vista, Windows® 7, Windows® 8, Windows® XP, and Notepad® are registered trademarks of
Microsoft Corporation.

DENT Instruments | 925 SW Emkay Dr. | Bend, Oregon 97702 USA
Phone 541.388.4774 | Fax 541.385.9333 | www.DENTInstruments.com

Table of Contents

INTRODUCTION	6
PowerScout 3037 Serial/ PowerScout 3037 Ethernet.....	6
Unpacking the Unit	6
Meter Anatomy	8
PowerScout™ Meter Safety Summary and Specifications.....	9
Symbols on Equipment	9
PowerScout™ Résumé de Sécurité et Spécifications.....	12
Symboles des Equipements	12
PowerScout 3037 Technical Specifications.....	14
PREPPING FOR FIELD INSTALLATION	16
Installing the ViewPoint Software	16
Connecting a Communication Cable.....	17
Connecting and Communicating via a USB or RS-485 Adapter	17
Connecting and Communicating via an Ethernet (TCP/IP) Connection	22
Communications LEDs	25
PS3037 Serial.....	25
PS3037 Ethernet.....	25
Version Control.....	25
Meter Setup.....	26
Entering Wiring Information for an Element	27
Selecting a Scalar.....	29
Comms Setup.....	31
RS-485 Settings.....	32
BACnet Device Settings	32
Ethernet Settings.....	32
Connecting the Ports	32
Establishing Communication Protocol.....	33
Switching between BACnet and Modbus Mode	33
FIELD INSTALLATION	36
Mounting a PowerScout 3037	36
Wiring Connections on the PowerScout 3037.....	37
Completing the Field Installation.....	38
Using the Pulse Output Port Function	38
Modbus Output Port Registers	39
BACnet Output Port Objects	39

Wiring CTs	40
Connecting Split-Core Style Millivolt CTs to a Load	41
Connecting RōCoil CTs to a Load	42
CT Wire Lead Polarity	44
Connecting Voltage	44
Powering the Meter	45
PowerScout Single-Phase Connections	45
PowerScout 3037 Wiring Diagrams	47
Three-wire Delta	47
Four-wire Wye	48
Two-wire Single Phase	49
Three-wire Single Phase	50
Verifying Installation with PhaseChek	51
Verifying Installation with the ViewPoint Software	53
Real-Time Values	53
Read/Write Registers—Read/Set Objects	55
Firmware	57
ALL THINGS MODBUS	59
Device Registers	59
Configuration Registers	59
Pulse Output/Input Registers	61
Absolute Measurement Registers	61
Positive Power/Energy Measurement Registers	65
Negative Power/Energy Measurement Registers	69
Net Measurement Registers	74
Protocol Commands	76
ALL THINGS BACNET	80
Editable Fields	80
Meter Specific Objects	80
Configuration Objects	81
Pulse Output/Input Objects	83
Absolute/Net Value Measurement Objects	83
Positive Power/Energy Measurement Objects	86
Negative Power/Energy Measurement Objects	87

APPENDICES.....	88
Appendix A—Additional Wiring Diagrams.....	88
2-CT, 3-Wire Delta	89
3-Phase Delta with a “Wild” Leg	90
Appendix B—Connecting Multiple PowerScouts to an RS-485 Network	91
Communication Protocol	91
Daisy Chain Layout for RS-485 Network.....	91
Networking Using the BACnet MS/TP/Modbus RTU Protocol	91
Appendix C—VERIS H8035/H8036 Emulation	92
VERIS Modbus Integer Registers	93
VERIS Multipliers	94
VERIS Modbus Floating Point Registers	96
Appendix D—Conversion Table	99
Decimal to Hexadecimal Conversion Table	99
Appendix E—The PS3037 Optional Visual Display.....	101
Appendix F—Troubleshooting	102
Troubleshooting Communication Issues.....	102
 FREQUENTLY ASKED QUESTIONS	 104
 GLOSSARY	 106

INTRODUCTION

PowerScout meters monitor the voltage, current, power, energy, and many other electrical parameters on single- and three-phase electrical systems. A PowerScout meter uses direct connections to each phase of the voltage, and uses current transformers to monitor each phase of the current. Information on energy use, demand, power factor, line frequency, and more are derived from the voltage and current inputs.

The communications interface to the meters is an RS-485 serial or Ethernet connection that uses the BACnet Master Slave Token Passing (MS/TP) protocol or Modbus protocol for sending commands and retrieving data. A separate remote terminal unit (RTU), Data Logger, or Building Management and Control System is usually connected to the PowerScout to provide data recording and trend logging plus a human interface or display.

POWERSCOUT 3037 SERIAL/ POWERSCOUT 3037 ETHERNET



The PowerScout 3037 is light-weight and compact enough to mount within an electrical panel. It is used for long-term monitoring of electrical systems.

Up to 127 PowerScout 3037 serial meters may be connected to a single BACnet MS/TP network for monitoring and recording power usage at

multiple locations within a single site. Up to 247 serial meters may be connected to a Modbus RTU network. You may connect as many Ethernet units as equal to the amount of available IP Addresses.

There is a configurable digital pulse output port on the PowerScout 3037 that can be used to output kWh, kVARh, or kVAh pulses to external devices, or to toggle on and off to control a remote device or relay.

PowerScout 3037 Optional Digital Display

An optional visual display is available on the PS3037 which cycles through meter information and real-time values of Volts, Amps, KW, KVA, KVAR, etc. See Appendix.

Unpacking the Unit

Your PowerScout meter comes with documents such as the Certificate of Calibration (COC) that has information about the meter and is valuable for tech support. Be sure to set these documents aside in a safe place when not in use.

If a Comm package was purchased as well, look for the ViewPoint software and the USB adapter. Verify that all connectors are included (CT, voltage, comm, pulse).

Power Scout Certificate of Calibration

Logger Information

Date: May 29, 2014	Time: 02:17 PM	Serial #: S371406014
Technician: CAW	Firmware Version: 4.19	Product Type: PS3037SERIAL
MAC ID Address:		
Customer:	Part #:	Description:

Logger Measurements

Volts Measurement:	Voltage Reading	Voltage Reference	Percent of Error	Pass / Fail
L1 Measurement:	320.558	320.610	0.016	PASS
L2 Measurement:	320.703	320.610	0.029	PASS
L3 Measurement:	320.571	320.610	0.012	PASS

Current Measurement:	Amperage Reading	Amperage Reference	Percent of Error	Pass / Fail
CT 1 Measurement:	1495.684	1495.778	0.006	PASS
CT 2 Measurement:	1495.752	1495.778	0.002	PASS
CT 3 Measurement:	1495.763	1495.778	0.001	PASS

Calibration Reference Instruments Used

DMM: Agilent Technologies 34411A, **Serial #:**MY48004275

DMM: Agilent Technologies 34411A, **Serial #:**MY48004529



The calibration of this device is traceable to the national Institute of Standards and Technology (NIST) using the above reference instruments.

Example of a COC for a PowerScout 3037

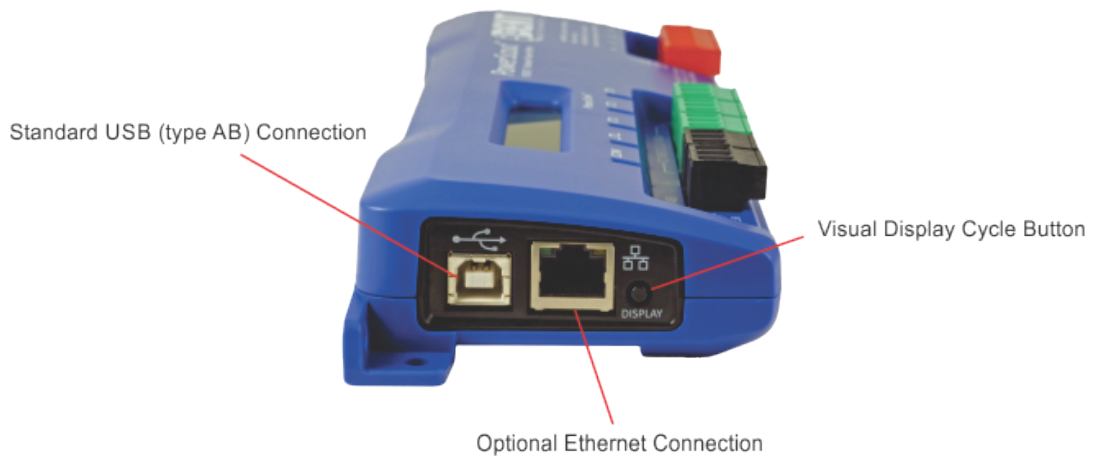
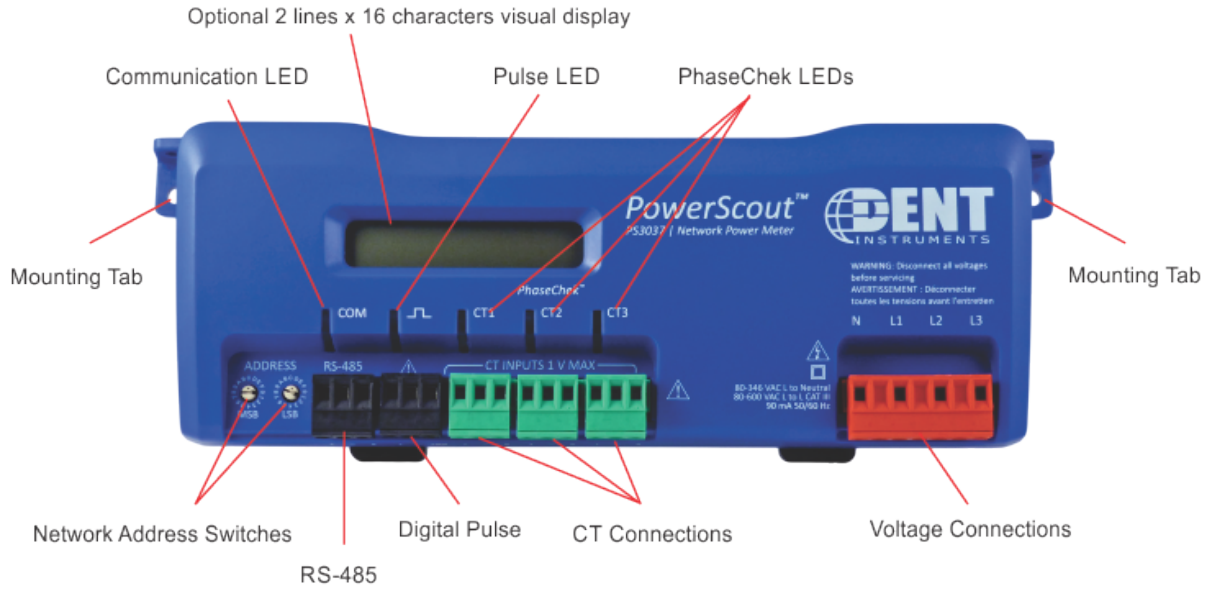
Meter Anatomy



PowerScout™ Meter Safety Summary and Specifications

<p>This general safety information is to be used by both the Logger operator and servicing personnel. DENT Instruments, Inc. assumes no liability for user's failure to comply with these safety guidelines.</p>	 <p>PS3037-S-N/PS3037-S-D/PS3037-E-N/ PS3037-E-D</p> 	<p>These items conform to the following:</p>  <p>PS3037 Series: Conforms to UL Std 61010-1, 3rd Edition & IEC 61010-2-030, 1st Edition Certified to CSA Std C22.2 No. 61010-1, 3rd Edition</p>
<p>The PowerScout is an Over-Voltage Category III device. Use approved rubber gloves with mechanical protection and goggles when operating the device.</p>		
<p>CAUTION: THIS METER MAY CONTAIN LIFE THREATENING VOLTAGES. QUALIFIED PERSONNEL MUST DISCONNECT ALL HIGH VOLTAGE WIRING BEFORE USING OR SERVICING THE METER.</p>		



WARNING

Use of this device in a manner for which it is not intended may impair its means of protection.

Symbols on Equipment



Denotes caution. See manual for a description of the meanings.



When connecting the PowerScout to an AC load, follow these steps in sequence to prevent a shock hazard.

1. De-energize the circuit to be monitored.
2. Connect the CTs to the phases being monitored.
3. Connect the voltage leads to the different phases. Use proper safety equipment (gloves and protective clothing) as required for the voltages monitored.



DENOTES HIGH VOLTAGE. RISK OF ELECTRICAL SHOCK. LIFE THREATENING VOLTAGES MAY BE PRESENT. QUALIFIED PERSONNEL ONLY.



PS 3037 Hazardous voltage exist, there are no user serviceable parts inside. Do not open the enclosure.



DO NOT EXCEED 600V. This meter is equipped to monitor loads up to 600V. Exceeding this voltage will cause damage to the meter and danger to the user. Always use a Potential Transformer (PT) for loads in excess of 600V. The PowerScout is a 600 Volt Over Voltage Category III device.



PS3037 Pulse output: 30V max open voltage, 5mA max current.

See *Pulse Output*.



SENSOR LIMITATIONS

USE ONLY SHUNTED CURRENT TRANSFORMERS (CTs).

Do not use other CTs. Only use shunted CTs with a 333mV maximum output only. Serious shock hazard and logger damage can occur if unshunted CTs are used. The UL listing covers the use of the following DENT Instruments CTs that are UL Recognized and have been evaluated to IEC 61010-1:

CT-RGT12-XXXX (solid core), CT-SRS-XXX (split core), CT-HSC-020-X (20A Mini), CT-HSC-050-X (50A Mini), CT-HMC-0100-X (100A Midi), CT-HMC-0200-X (200A Midi), CT-RXX-1310-U (RöCoil), CTRXX-A4-U (RöCoil), CT-CON-1000-X, CT-CON-0150EZ-X and the CT-SRL-XXX.

The use of any other CT will invalidate the UL Listing.



FCC COMPLIANCE

PS3037-S-N/PS3037-S-D/PS3037-E-N/PS3037-E-D

This device has been tested and found to comply with the limits for a Class A digital device, pursuant to part 15 of the FCC Rules. These limits are designed to provide reasonable protection against harmful interference when the equipment is operated in a commercial environment. This equipment generates, uses, and can radiate radio frequency energy and, if not installed and used in accordance with the instruction manual, may cause harmful interference to radio communications. Operation of this equipment in a residential area is likely to cause harmful interference in which case the user will be required to correct the interference at user's own expense.

Operation is subject to the following two conditions: (1) This device may not cause harmful interference, and (2) this device must accept any interference received, including interference that may cause undesired operation.



DC VOLTAGES

The PowerScout 3037 is designed to measure AC voltages for installations up to 600 VAC. The PowerScout 3037 is also capable of measuring DC voltages up to 600 VDC with the following caveats.

- 1) The internal fuse installed in the PowerScout 3037 is not a suitable disconnect for voltages above 80 VDC. Customers using the PowerScout 3037 for high voltage DC systems must install a UL listed inline 600 volt DC fuse with a rating of 1 amp or less. These fuses are commonly available in the solar power market.
- 2) UL and ANSI testing of the PowerScout 3037 was conducted on AC systems only. DC results are comparable but not tested.
- 3) DENT Instruments VIEWPOINT software does not currently have a configuration or registers that are specific to DC systems. Values reported for voltage, current, KW, KWH will be correct however it should be noted that the meter will also report values that pertain to AC systems (such as VARs and Power Factor) that should be ignored.



Equipment protected throughout by double insulation (IEC 536 Class II).

MAINTENANCE

There is no required maintenance with the **PowerScout**. Abide by the following items:

Cleaning: No cleaning agents, including water, shall be used on the **PowerScout**.

Battery Life (If equipped): The lithium battery is only used to maintain the date and clock settings during power failure and has a life expectancy of greater than 10 years. Contact DENT Instruments for service.

No accessories are approved for use with the **PowerScout** other than those specified in the DENT Instruments product literature and price sheets.

If the logger appears damaged or defective, first disconnect all power and sensors. Call or email technical support for assistance.

DENT Instruments

Bend, Oregon USA

Phone: 541.388.4774

DENTinstruments.com

Email: techhelp@DENTinstruments.com

PowerScout™ Résumé de Sécurité et Spécifications

<p>Cette information de sécurité est destinée à être utilisée à la fois par l'opérateur de l'enregistreur et le personnel de service. DENT Instruments, Inc n'assume aucune responsabilité pour l'utilisateur qui ne respecte pas les directives en matière de sécurité.</p>	<p> PS3037-S-N/PS3037-S-D/PS3037-E-N/ PS3037-E-D</p> <p></p>	<p>Tous les articles sont conformes à ce qui suit:</p> <p></p> <p>PS3037 Série: Conforme à UL Std 61010-1, 3rd Edition & IEC 61010-2-030, 1st Edition Certifié CSA Std C22.2 No. 61010-1, 3rd Edition</p>
<p>Le PowerScout est un appareil de surtension de catégorie III. Utiliser des gants en caoutchouc approuvé avec protection mécanique et des lunettes lors de l'utilisation de l'appareil.</p>		
<p>ATTENTION: CE METER PEUT CONTENIR DE HAUTES TENSIONS QUI PEUVENT ÊTRE DANGEREUSES. UN PERSONNEL QUALIFIÉ DOIT DÉBRANCHER TOUS LES CÂBLES À HAUTE TENSION AVANT D'UTILISER OU DE RÉPARER DU METER.</p>		



ATTENTION

L'utilisation de cet appareil d'une manière pour laquelle il n'est pas destiné peut annuler ses moyens de protection.

Symboles des Equipements



Signifie prudence. Voir le manuel pour une description de la signification.



En faisant la connexion du PowerScout à une prise de courant alternatif, suivez ces étapes en ordre pour empêcher un risque de choc.

1. Décharger le circuit à contrôler.
2. Connectez le TC aux phases à surveiller.
3. Connectez les fils de tension à des phases différentes. Utiliser des équipements de sécurité (gants et des vêtements de protection) qui sont nécessaires pour les tensions surveillées.



INDIQUE HAUTE TENSION. RISQUE DE CHOC ÉLECTRIQUE. HAUTES TENSIONS PEUVENT ÊTRE PRÉSENTES QUI METTENT LA VIE EN DANGER. PERSONNEL QUALIFIÉ UNIQUEMENT.



PS 3037 tension dangereuse existant, il n'y a aucune pièce réparable par l'utilisateur n'ouvrez pas le boîtier.



NE PAS DEPASSER 600V. Ce compteur peut contrôler les charges jusqu'à 600V. Le dépassement de cette tension peut causer des dommages à l'appareil et du danger pour l'utilisateur. Utiliser toujours le potentiel transformateur (PT) pour des charges de plus de 600V. Le PowerScout est un appareil à 600 V de surtension de catégorie III.



PS3037 sortie d'impulsion: 30V max tension ouverte, 5 mA courant maxi. Voir sortie par impulsion.



LIMITATIONS DE DÉTECTEUR

UTILISEZ SEULEMENT TRANSFORMATEURS DE COURANT (TC) SHUNTÉE.

N'utilisez pas d'autres TC. Utilisez seulement des TC shuntée avec une puissance maximale 333mV. Un sérieux risque de décharge électrique et des dommages à l'enregistreur peut se produire si des TC pas shuntée sont utilisés. Utiliser seulement les CTs des DENT Instruments suivants qui sont énumérés jusqu'au 600V/CATIII.

CT-RGT12-XXXX (solid core), CT-SRS-XXX (split core), CT-HSC-020-X (20A Mini), CT-HSC-050-X (50A Mini), CT-HMC-0100-X (100A Midi), CT-HMC-0200-X (200A Midi), CT-RXX-1310-U (RöCoil), CTRXX-A4-U (RöCoil), CT-CON-1000-X, CT-CON-0150EZ-X et le CT-SRL-XXX.

L'utilisation de tout autre CT annulera la certification UL.



TENSIONS C. C.

La PowerScout 3037 est conçu pour mesurer tensions c. a. pour les installations jusqu'à 600 V c. a. Le PowerScout 3037 est également capable de mesurer les tensions c. c. jusqu'à 600 V c. c. avec les avertissements suivants.

- 1) Le fusible interne installé dans le PowerScout 3037 n'est pas un dispositif de désaccouplage adéquat pour des tensions supérieures à 80 V c. c. Les clients utilisant la PowerScout 3037 pour haute tension DC systèmes doivent installer un UL inline 600 volts DC fusible avec une valeur nominale de 1 amp ou moins. Ces fusibles sont couramment disponibles dans le marché des piles solaires.
- 2) UL ANSI et tests du PowerScout 3037 a été menée sur systèmes CA uniquement. DC résultats sont comparables, mais pas testé.
- 3) Impact Instruments logiciel VIEWPOINT ne dispose actuellement pas de configuration ou de registres qui sont spécifiques aux systèmes à courant continu. Les valeurs rapportées pour la tension, le courant, en KW, KWH sera correct mais il convient néanmoins de noter que le compteur sera également rapport valeurs qui se rapportent aux systèmes à courant alternatif (tels que VARs et facteur de puissance) qui doit être ignoré.



L'équipement protégé en double isolation (IEC 536 Classe II)

Entretien

Il n'y a aucun entretien requis avec le **PowerScout**. Respectez les points suivants:

Nettoyage: Aucun agents de nettoyage, y compris l'eau, doit être utilisé sur le **PowerScout**.

Espérance de Vie de la Batterie: La pile au lithium est utilisée uniquement pour maintenir les paramètres de date et d'heure en cas de coupure de le courant et a une espérance de vie de plus de 10 ans. Contactez DENT Instruments pour le service.

Pas d'accessoires approuvés pour une utilisation avec le **PowerScout** sauf ceux spécifiés par DENT Instruments dans ses documentations sur les produits et également sur les prix.

Si le compteur semble endommagé ou défectueux, tout d'abord déconnecter le pouvoir de l'appareil. Alors s'il vous plaît appelez 541.388.4774 ou contacter par courriel l'assistance technique pour obtenir de l'aide.

DENT Instruments

Bend, Oregon USA

Phone: 541.388.4774

DENTinstruments.com

Email: techhelp@DENTinstruments.com

PowerScout 3037 Technical Specifications

Specification	Description	
Service Types	Single Phase, Three Phase-Four Wire (WYE), Three Phase-Three Wire (Delta)	
3 Voltage Channels	80-346 Volts AC Line-to-Neutral, 600V Line-to-Line, CAT III	
Current Channels	3 channels, 0.525 VAC max, 333 mV CTs, 0-4,000+ Amps depending on current transducer	
Maximum Current Input	158% of current transducer rating (mv CTs) to maintain accuracy. Measure up to 4000 Amps RōCoil CTs	
Measurement Type	True RMS using high-speed digital signal processing (DSP)	
Line Frequency	50/60Hz	
Power	From L1 Phase to L2 Phase. 80-600VAC CAT III 50/60Hz, 90mA Max. Non-user replaceable .5 Amp internal fuse protection	
Power Out	Unregulated 5VDC output, 140 mA max	
Waveform Sampling	12 kHz	
Parameter Update Rate	.5 seconds	
Measurements	Volts, Amps, kW, kWh, kVAR, kVARh, kVA, kVAh, Apparent Power Factor (aPF), Displacement Power Factor (dPF). All parameters for each phase and for system total.	
Accuracy	0.2% (<0.1% typical) ANSI, C12.20-2010 Class 0.2	
Resolution	0.01 Amp, 0.1 Volt, 0.01 watt, 0.01 VAR, 0.01 VA, 0.01 Power Factor depending on scalar setting	
Indicators	Bi-color LEDs (red and green): 1 LED to indicate communication, 3 LEDs for correct phasing (PhaseChek™: Green when voltage and current on the same phase; Red when incorrectly wired.) Pulse output LED.	
Pulse Output	Open Collector, Optically Isolated , 5mA max current, 30V max open voltage	
Communication		
Direct	User Selectable Modbus RTU or BACnet Master Slave Token Passing protocol (MS/TP) RS-485 or Ethernet	
Serial Meters	Max Communication Length	1200 meters with Data Range of 100K bits/second or less
	RS-485 Loading	1/8 unit
	Communication Rate (baud)	Modbus: 9600 (Default), 19200, 38400, 57600, 76800, 115200 BACnet: 9600, 19200, 38400, 76,800 (Default)
	Data Bits	8
	Parity	None, Even, Odd
	Stop Bit	2, 1
Data Formats	Modbus Protocol -or- BACnet Master Slave / Token Passing (MS/TP) protocol	

Mechanical	
Operating Temperature	-7 to + 60° C (-20 to 140° F)
Humidity	5% to 95% non-condensing
Enclosure	ABS plastic, 94-V0 flammability rating
Weight	340 g (12 ounces), exclusive of CTs
Dimensions	24.2 x 8.5 x 4.0 cm (9.5" x 3.3" x 1.6")
Accessories	
Mounting Rail	Compatible with a TS35/7 DIN Rail Channel
Digital Display	An optional 2 x 16 character display which auto-cycles between informational screens every 2-3 seconds, with real-time values updated every second.
ViewPoint™ Minimum System Requirements	
Operating System	Windows® 7 (32 or 64 bit), Windows® 8 Pro, Vista (32 or 64 bit), XP
Communications Port	One USB port or serial port
Hard Drive	50 MB minimum available
Processor	Pentium Class 1 GHz or more recommended
Safety	
Serial/Ethernet Meters	<p>The following are UL listed: PS3037-S-N/PS3037-S-D/PS3037-E-N/PS3037-E-D</p> <p>The PS3037 Series: Conforms to UL Std 61010-1, 3rd Edition & IEC 61010-2-030, 1st Edition Certified to CSA Std C22.2 No. 61010-1, 3rd Edition</p>

Table I-1: Technical Specifications

PREPPING FOR FIELD INSTALLATION

There are multiple tasks that are typically completed before heading to the field, usually by your technical support personnel. These include determining how to communicate with the meter, setting address switches, installing ViewPoint, etc. Communication configuration must be set up in the ViewPoint software even if you use a separate logger to record data. The more tasks completed before installation means less time in the field.

These determinations figure into how you set up the PowerScout meter for operation:

- BACnet vs. Modbus
Set the network address switches on the meter to either Modbus or BACnet
- RS-485 vs. Ethernet
The type of connection is part of the configuration set up in the ViewPoint software
- Laptop/PC for setup verification via USB
A convenient method for setup before going in the field, and once in the field, to easily read real-time values

NOTE: Installation of the ViewPoint software and a communication cable should be completed and tested with a meter prior to the field installation. A USB cable can be used when configuring the meter in this manner.

Installing the ViewPoint Software

***DID YOU KNOW?** ViewPoint may be installed on multiple computers.*

The ViewPoint software is designed to let you easily configure the PowerScout for different current transformers, check readings, and verify correct setup. All of DENT Instruments PowerScout meters use ViewPoint software to communicate with the meter. It needs to be installed on any computer talking to the PowerScout 3037. ViewPoint is compatible with Windows® 7 (32 or 64 bit), Windows® 8 Pro, Vista (32 or 64 bit), or XP.

- Insert the ViewPoint CD into the CD-ROM drive.

The installer starts automatically. If it does not, browse to the CD and locate the ViewPointInstaller.exe program. Start the installer by double-clicking **ViewPointInstaller.exe**.

The Communication screen is displayed when ViewPoint is first started. This is where the software networking parameters are entered to match the PowerScout networking configuration (meter type, COM port, baud rate, base address, etc.). ViewPoint remembers your last connection and displays those previous selections when opening the software once again.

NOTE: ViewPoint software serves several functions, such as setting up a meter, getting real-time values, and read/write registers and objects, but for the purpose of prepping for field installation only three are important to the process: Communications, Meter Setup, and Comms Setup. The other functions are described later in this document.

Connecting a Communication Cable

There are various ways to communicate with a PowerScout meter and how you do so will determine what type of cabling system you will use. To set up the meter, communication can be established with a USB cable, an RS-485 adapter, or an Ethernet cable. Once in the field, communication between a PowerScout meter and a logger is established with a RS-485 or an Ethernet connection. A RS-485 connection is limited in speed while an Ethernet connection is much faster.

NOTE: PowerScout meters are ordered from DENT Instruments based on the type of desired connection.

CONNECTING AND COMMUNICATING VIA A USB OR RS-485 ADAPTER

A type AB USB cable may be used between a PC and a PS3037 meter and is the preferred method for setting up a PS3037 with Modbus protocols. The USB cable will also power the meter when connected to a PC. When using a USB cable with a PC, each USB port on the PC generates a unique comm port in the ViewPoint software, such as Com3 or Com4.

NOTE: A USB driver is installed when you install the ViewPoint software.

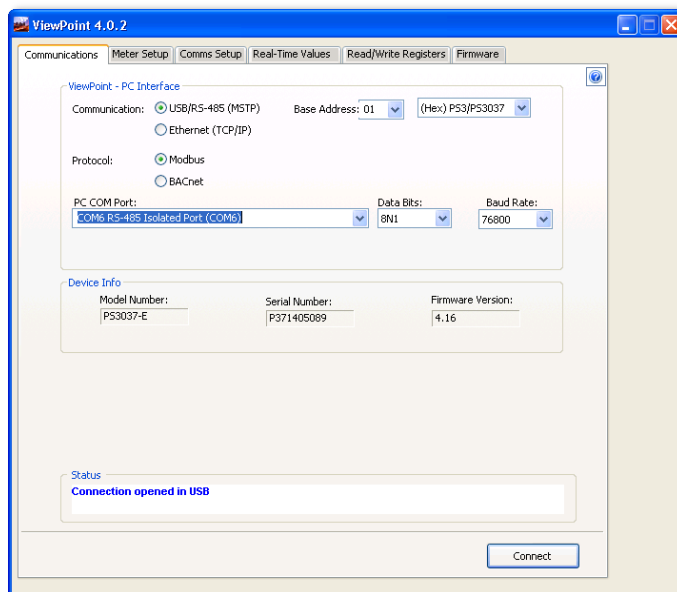

ViewPoint can read information through a USB, an RS-485 isolated COM port, or an Ethernet connection. When the RS-485 connection is selected a base address is required (the base address is the rotary switch settings). Address switches are ignored by both USB and Ethernet. When the Ethernet connection is selected an IP address is required. The screen display changes based on your connection selection.

The USB connector on the PowerScout 3037 can be used to power the unit when configuring it using ViewPoint and Modbus protocols.

If connecting with a USB cable is not practical, the use of an RS-485 to USB adapter connected to your PC may be used for communicating with your PowerScout. First, install the driver on the computer and then complete the connection between the meter and the computer by plugging the RS-485 connector into the meter.

Did You Know? If an RS-485 adapter is used instead of a USB, an RS-485 driver must be installed on your computer and power applied to the PowerScout meter before the software will function properly.

Installing the RS-485 Adapter on a Computer

NOTE: If ViewPoint was installed first, it needs to be restarted following an RS-485 driver installation. If an RS-486 port does not appear in the drop-down list, the RS-485 was not installed correctly.

- 1) Insert the CD that came with the RS-485 adapter into your computer.
- 2) Insert one end of a USB cable into the RS-485 adapter and the other end into a USB port on the computer.
- 3) The Found New Hardware Wizard window appears.

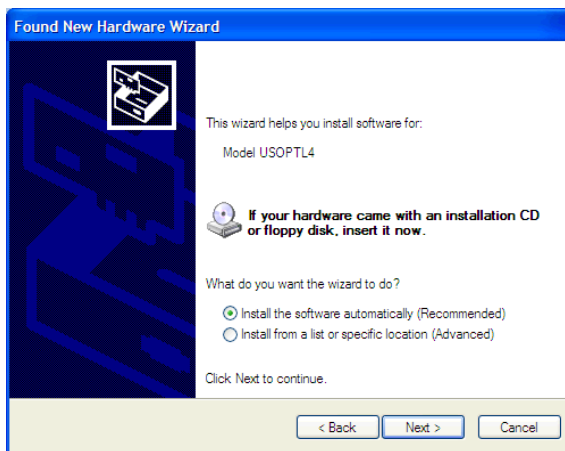

The window states “This wizard helps you install software for: Model USOPTL4,” and asks “What do you want the wizard to do?”

- 4) Select Install the software automatically and click Next.
- 5) Click **Finish** when the installation is complete.

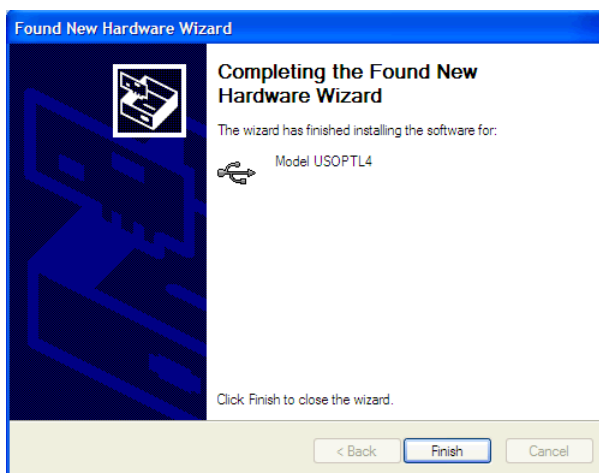

- 6) Remove the CD from your computer.

Connecting the Adapter to the Meter

The three wires coming from the RS-485 adapter are plugged into the COM connector. Insert each white ferrule into the appropriate slots on the connector. The red wire inserts in the left slot (+), the black wire in the middle slot (-), and the green wire in the right slot (Shield), Figure II-1 and Figure II-3. Verify that the dip switches on the back of the RS-485 adapter are set to **RS-485, Echo Off, 2 Wire, 2 Wire** as shown in Figure II-2 before plugging the adapter into the PowerScout 3037.

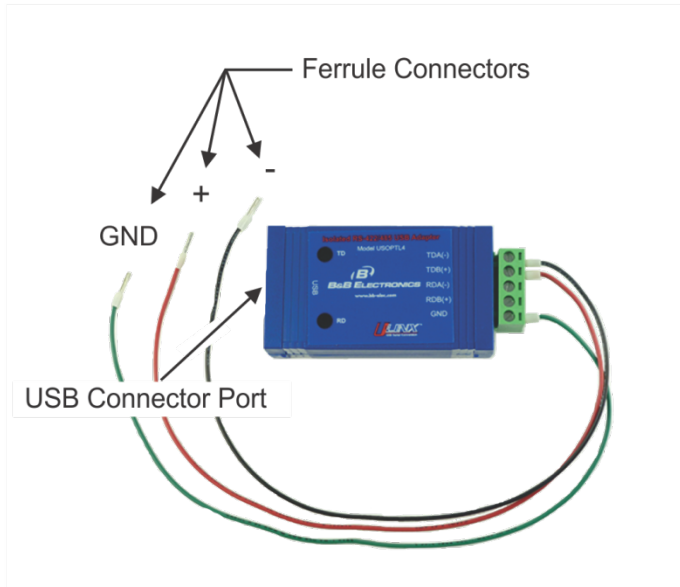

Figure II-1: RS-485 Adapter

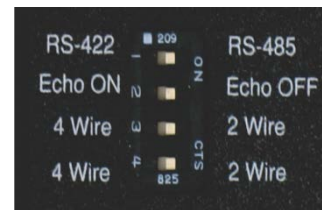

Figure II-2: Dip switches on back of RS-485 Adapter

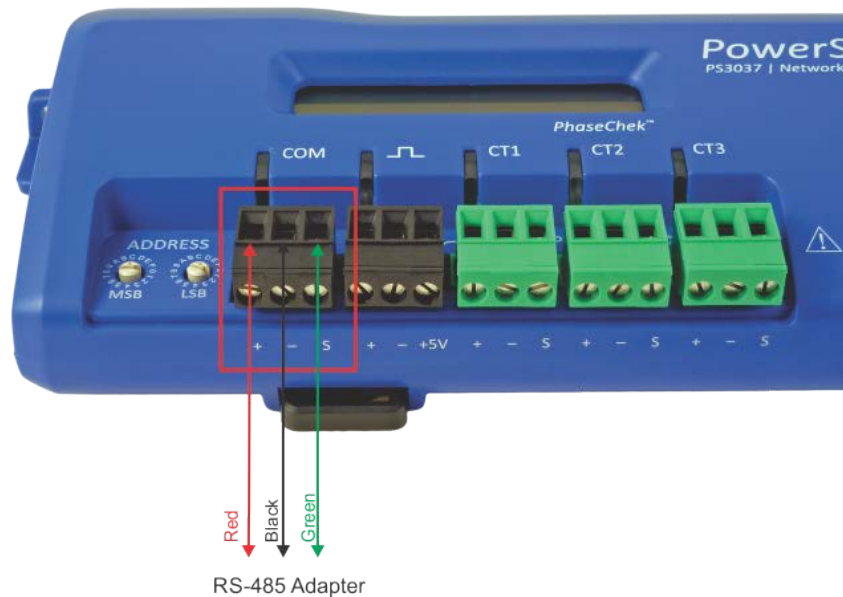
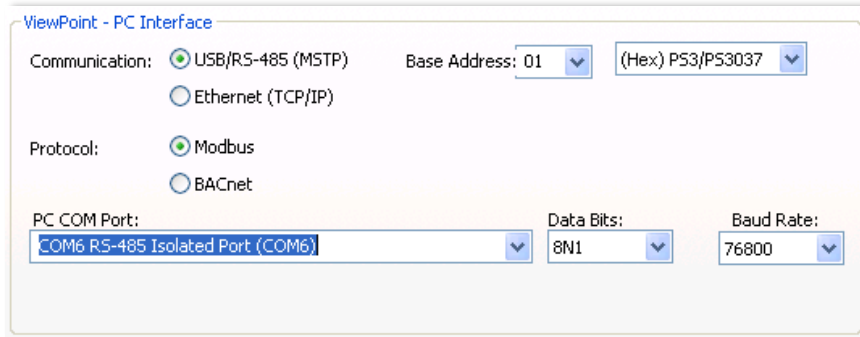

Figure II-3: RS-485 Connector on PS3037

NOTE: USB is always active on the PS3037 (and the protocol is Modbus over the USB virtual communications port).

NOTE: If ViewPoint was installed first, it needs to be restarted following a RS-485 driver installation. If a RS-485 port does not appear in the drop-down list, the RS-485 was not installed correctly.



- 1) Select **USB/RS-485 (MSTP)** as your communication type.
- 2) Select PS/PS3037.
- 3) When connecting with an RS-485, enter a base address that matches the switches on the PowerScout. A USB connection ignores address switches. See *Setting the Network Address Switches* below.
- 4) When connecting with an RS-485, select **Modbus** or **BACnet** as your communication protocol. When communicating over USB, whether the PS3037 is configured for Modbus or BACnet mode, the PS3037 will communicate over the Modbus protocol.
- 5) Select the **PC COM Port** from the drop-down list. For a USB connection, select “COMxx DENT USB” in the field, where “xx” is the port number. For an RS-485 connection using an RS-485 adapter, select COMxx RS-485 Isolated Port (COMxx) where "xx" is the COM port number.

Default settings are used for the two remaining fields: **Data Bits** is 8N1 and the **Baud Rate** is 9600. When BACnet is selected as your protocol an additional read-only field appears displaying the *BACnet Device ID*.

Setting the Network Address Switches

There are two rotary network address switches on a serial PowerScout 3037, labeled MSB and LSB. These two switches are used to select the BACnet/Modbus address the client uses to communicate with the PowerScout.

The rotary switches are 16-position, hexadecimal switches. The default factory setting is hex 01. The address is a hexadecimal (hex) value, represented by the digits 0 through 9 and letters A through F. For example, a network address of 100 in decimal is converted to 64 hexadecimal and set on the PowerScout 3037 by:

- MSB switch—select 6
- LSB switch—select 4

In some cases the hex value may need to be converted to decimal when entered into the RTU or data logger. See the Appendix for a hexadecimal conversion table.

The BACnet MS/TP MAC and Modbus address is a decimal value, represented by three digits: 000 through 009, 010-090, and 100-999.

Note: BACnet MS/TP masters only support addresses 001–127.

Hexadecimal Address	BACnet Address Availability
00	Reserved for resetting the PowerScout to Modbus mode with 9600 baud, 8 bit, 1 stop bit and no parity.
01-7F	Available (01/001 is the factory default setting).
80-FE	Reserved for BACnet slave devices.
FF	The rotary switches can be used to configure the communication protocol to BACnet or Modbus as well as changing the baud rate if unsure of the current settings (PS3037 only).

Table II-1: BACnet Hexadecimal Address Availability

Hexadecimal Address	Modbus Address Availability
00	Reserved for resetting the PowerScout to Modbus mode with 9600 baud, 8 bit, 1 stop bit and no parity.
01-F7	Available for Modbus slave devices.
	Reserved for network wide broadcast.
FF	The rotary switches can be used to configure the communication protocol to BACnet or Modbus as well as changing the baud rate if unsure of the current settings (PS3037 only).

Table II-2: Modbus Hexadecimal Address Availability

Communication Error

If ViewPoint is unable to communicate with the PowerScout, the **Status** window displays the following message in the *Status* field:

“Unable to establish connection with meter, please check settings and try again.”

Try the following to resolve the communication error on a serial PowerScout:

- No RS-485 option available in the PC COM Port drop-down list—indicates the PowerScout is not properly connected or the required software driver is not installed.
- Modbus Base Address Switch does not match the selected hex switch settings on the PowerScout—change the switch settings.
- The selected Baud Rate does not match the PowerScout baud rate—change the baud rate.

For more information, refer to the Appendix, *Troubleshooting Communication Issues*.

CONNECTING AND COMMUNICATING VIA AN ETHERNET (TCP/IP) CONNECTION

Connect one end of the Ethernet cable into the PowerScout and the other end into your computer or network. To begin communicating via an Ethernet cable you must first set it up within the ViewPoint software that came with the meter. See **Ethernet (TCP/IP) Connection** in the *Communicating with a PowerScout Meter* section.

The meter will require power to communicate over Ethernet. Power can be supplied by connecting the USB or voltage lines 1 and 2.

PowerScout 3037



Figure II-4: Ethernet Connection

Keep in mind that the Ethernet connection must have an IP Address in the ViewPoint software that can either be set manually within the software with the *Use Static IP* address option (for a fixed address) or obtained automatically from the router connected to the logger using the *Use DHCP* option (dynamic address). Both options have advantages. See **About IP Addresses** further in this document.

NOTE: When Ethernet is connected, any RS-485 connection is inactivated. The PS3037 must be power cycled with the Ethernet cable removed in order to activate the RS-485 interface.

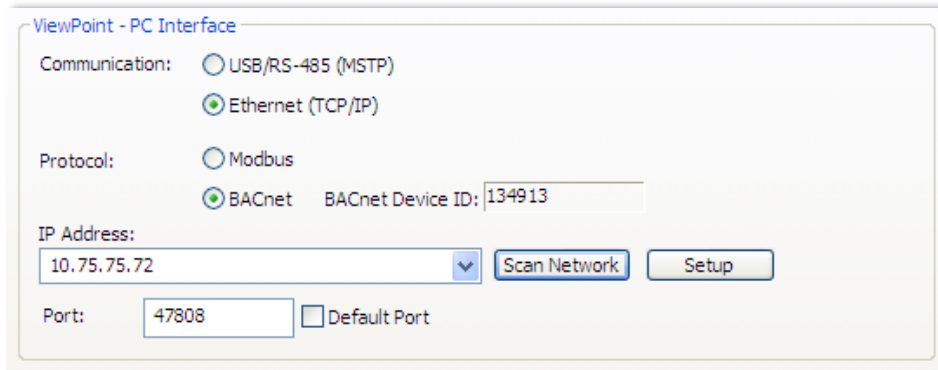

- 1) Select **Ethernet (TCP/IP)** to gather information via a network connection. When selected, the Communications Setup screen changes and an **IP Address** is required as address switches are ignored.
- 2) Select your mode of communication.
- 3) Enter the **IP Address** for the Ethernet connection of the meter or select one of the previously used addresses from the drop-down list. See *About IP Addresses* on the following page.
-or-
Use the **Scan Network** or **Setup** buttons to acquire a new IP Address. See *About IP Addresses* on the following page.
- 4) Enter the **Port** connected to the PowerScout. A checkbox is available to make the port the default. Different networks may require different ports. See *your network administrator*.

About IP Addresses

The Ethernet connection must have an IP Address that is set manually in the **IP Address:** field or obtained automatically from the router connected to the meter using the Use DHCP option (dynamic address) found in the Logger Network Setup dialog box accessed via the **Setup** button. Both options have advantages.

NOTE: A Static IP address of 192.168.1.10 is assigned in the factory to all Ethernet PowerScouts.

- **Static Connection:** If you know an IP address that is not being used by another device on the network, enter that address into the **IP Address:** field. This may require permission from a network administrator. With a static IP address it is easy to connect to the meter as there is no doubt about what IP address to use.
- **Dynamic Connection:** If you want the router to assign an IP address to the meter automatically, select Use DHCP. This may avoid the need of a network administrator as the router will assign an IP address that does not conflict with any other devices on the network. A disadvantage of the DHCP option is that the "lease" of the IP address may expire after a period of time and the router could assign a different IP address. A new IP address means that ViewPoint cannot connect to the meter until the new IP address has been entered. (See below.)

An additional option is to set the meter to DHCP and go to the router and assign a specific IP address to the MAC address that corresponds to the meter. In this way, if the lease does expire, the router will

always assign the same IP number back to the meter. This option may also require a network administrator.

The **Scan Network** button scans the network for possible meters and displays them in the Logger Selection dialog box. Look for the serial number on the meter (found on the back of the meter) to determine which connection point is yours.

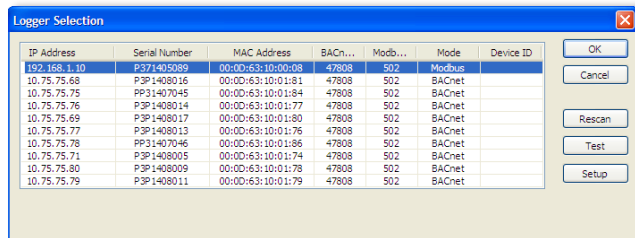

- Select the correct device from the list of IP Addresses and click **OK**.

The **Setup** button displays the Logger Network Setup dialog box where network address information is entered. *See your network administrator before making changes.*

When you select the **Use DHCP** checkbox the Dynamic Host Configuration Protocol is used to populate the IP Address, Subnet Mask, and Gateway Address fields automatically.

NOTE: Each meter connected to the network requires its own unique network IP address. An address is provided automatically if the network allows DHCP (Dynamic Host Configuration Protocol) and the meter is configured to request an address.

- Click **Update Logger** after making your selections.

ViewPoint displays the following message when the connection is successful:

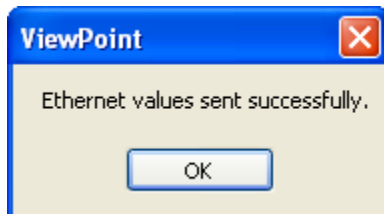

Communications LEDs

The PowerScout COM LEDs signal the following communication information.

PS3037 SERIAL

BACnet	Modbus	Description
Steady Green	Steady Green	Power is applied to the meter.
Flashing Green	Flashing Green	The meter is communicating.
	Steady Red	Communications failure, or talking with BACnet while the meter is in Modbus mode.
	Flashing Red	The meter is receiving communication on the bus for a meter at another address.

Table II-3: PS3037 Serial COM LED Signals

PS3037 ETHERNET

The Ethernet cable has a Link LED on its connector that glows amber when connected to the network and flashes green during Ethernet traffic.

BACnet/Modbus	Description
Steady Green	Power is applied to the meter.
Flashing Green	The meter is communicating.

Table II-4: PS3037 Ethernet COM LED Signals

Version Control

Installed versions of the software and firmware are checked when first connecting the meter. A pop-up dialog box appears if either of those is out of date:

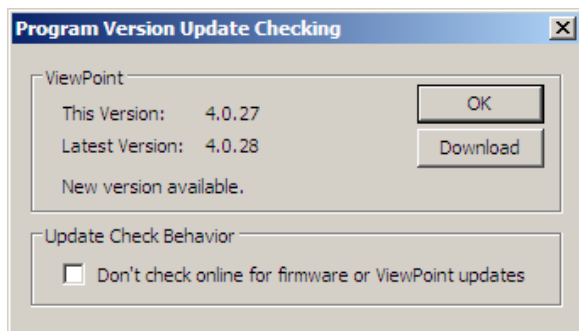

ViewPoint Update Dialog

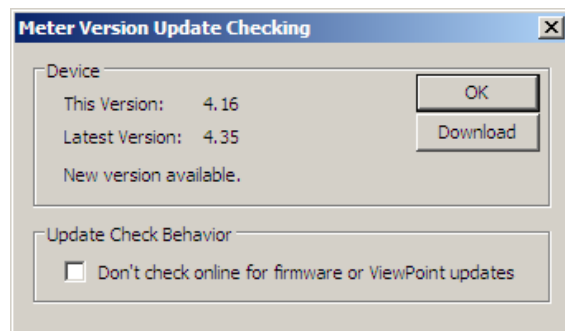

Firmware Update Dialog

Thereafter, the software is checked once every seven (7) days for the current version. Firmware is checked each time the meter is connected. You can stop the check for updates by selecting the **Don't check online for firmware of ViewPoint updates** check box.

Click **OK** to close the dialog box without updating.

-OR-

Click **Download** to begin the updating process. The DENT Instruments Tech Support Downloads website appears with a link to the download. Once you have the file downloaded to your computer, use the **Firmware** tab to download the file to the meter.

Meter Setup

Once communications is established between the PC and the PowerScout, you are now ready to configure the meter for the field. This is accomplished in the Meter Setup tab of ViewPoint.

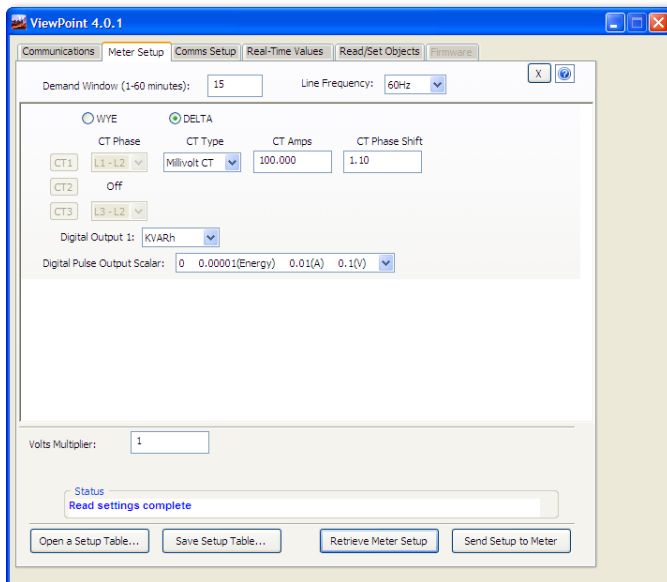

The **Meter Setup** screen allows unique changes to an element on the 3037. Within the element, *CT Phase*, *Type*, *Amps*, and *Phase Shift* are entered, based on wiring connection, for CT1, CT2, and CT3. The type of wiring connection and the *Digital Output* are also entered for the element. Overall, a *Demand Window* of 1–60 minutes is available for the recording of values and a *Line Frequency* of 50 Hz or 60 Hz is selectable. Also, the *Volts Multiplier* field can be altered when used with a step-down transformer to allow the meter to record values as if it was connected to a higher than 600V source.

NOTE: In PowerScout meters, Peak Demand is calculated using a moving window and is averaged across the selected demand window size. Each minute the total consumption is recalculated and compared to the last demand window. If the new window is larger than the last recorded value it is recorded. This value is calculated during the sampling of the waveform.

The Meter Setup screen is blank when first accessed. Click **Retrieve Meter Setup** to view the current status of the element. The Element Status dialog box displays while the element is read.

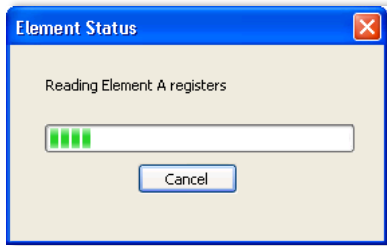

ENTERING WIRING INFORMATION FOR AN ELEMENT

Begin setup by entering an amount of time (1-60 minutes) into the **Demand Window** and selecting a **Line Frequency** from the drop-down list.

Use the following steps within an element:

- 1) Select **WYE** or **DELTA** as the wiring connection.

NOTE: DENT Instruments recommends using 3 CTs in a WYE connection for Delta loads.

- A *WYE* connection automatically displays all three CTs. Any changes made to CT1 also apply to CT2 and CT3.

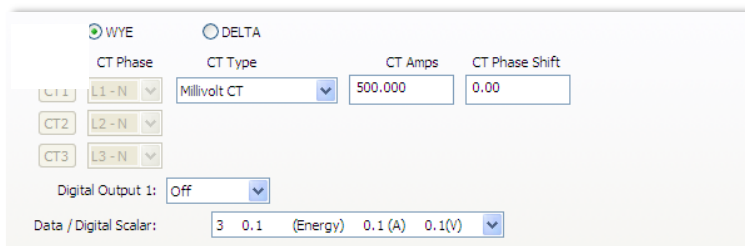

Wye Wiring Connection

- A *DELTA* connection displays only the two available CTs. Any changes made to CT1 also apply to CT3.

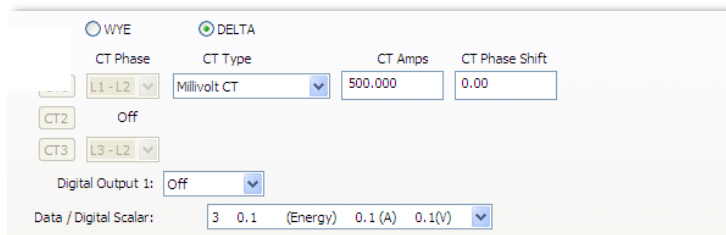

Delta Wiring Connection

- 2) Depending on the wiring connection, make changes to CT1, CT2, and/or CT3.
 - CT Phase—Shows the voltage of the referenced CT
 - CT Type—Use the drop-down list to select the type of CT attached to the PowerScout.
 - CT Amps—Enter the amperage rating.
 - CT Phase Shift—Enter in degrees the phase shift of the CT. The default is 1.1.

Current Transformers		Recommended CT Phase Shift Values
Clamp On	CT-CON-0150EZ	1.10°
	CT-CON-1000	0.20°
Split Core Small	CT-SCS-0050	2.20°
	CT-SCS-0100	2.20°
Split Core Medium	CT-SCM-0100	1.75°
	CT-SCM-0200	1.50°
	CT-SCM-0400	1.30°
	CT-SCM-0600	1.30°
Split Core Large	CT-SCL-0600	0.00°
	CT-SCL-1000	0.00°
Split Core High Accuracy	CT-SHS-0005	0.50°
	CT-SHS-0015	0.50°
Hinge Mini	CT-HSC-020	0.75°
	CT-HSAC-050	0.75°
Hinge MIDI	CT-HMC-0100	0.12°
	CT-HMC-0200	0.30°
Revenue Grade Toroidal Solid Core	CT-RGT12-0005	0.00°
	CT-RGT12-0020	0.00°
	CT-RGT12-0050	0.00°
	CT-RGT12-0100	0.00°
Revenue Grade Split Core	CT-SRS-005	359.9°
	CT-SRS-050	359.77°
	CT-SRL-100	0.06°
	CT-SRL-200	0.06°
	CT-SRL-400	359.94°

Table II-5: Recommended CT Phase Shift Value

- 3) Select a **Digital Output** from the drop-down list if being used.
- 4) Select a **Data/Digital Scalar** from the drop-down list.

SELECTING A SCALAR

Did You Know: The register value must be less than 65,535.

The use of Modbus protocols limits the data registers to a maximum of two bytes (16 bits) or a maximum decimal value of 65535. Modbus requires that the data be unsigned (positive) integer values. To overcome these limitations some measured (and stored) values must be *scaled* to fit into the Modbus registers. The raw value read from the Modbus registers is multiplied by a scalar to convert the raw data. The following table lists the data scalars and the respective values for the PowerScout.

Data Scalar	Scalar Value					
	kW/kWh Demand	kVAR/kVARh	kVA/kVAh	Power Factor	Amps	Volts
0	.00001	.00001	.00001	.01	.01	.1
1	.001	.001	.001	.01	.1	.1
2	.01	.01	.01	.01	.1	.1
3	.1	.1	.1	.01	.1	.1
4	1	1	1	.01	1	1
5	10	10	10	.01	1	1
≥6	100	100	100	.01	1	1

Table II-6: Data Scalars and Values for Registers 44001 thru 44061

The data scalar is stored in register 44602.

When selecting a data scalar, the following guidelines need to be considered:

- If the data scalar selected is too low, an incorrect data result is returned from the register.
- If the data scalar selected is too high, the significant digits following the decimal point are removed.

After selecting a data scalar, the formula for calculating the actual value is:

$$\text{register value} \times \text{scalar value} = \text{actual value}$$

Or, another way to state this formula is:

$$\text{actual value} / \text{scalar value} = \text{register value}$$

The following table is an example when selecting a data scalar for 3-phase loads based on the CT size or maximum current. These are the minimum recommended scalar settings.

CT Size or Max. Current	3-phase Loads	
	230 volts	460 volts
50	Scalar 1	Scalar 2
100	Scalar 2	Scalar 2
200	Scalar 2	Scalar 2
400	Scalar 2	Scalar 2
600	Scalar 2	Scalar 3
1000	Scalar 3	Scalar 3
3000	Scalar 3	Scalar 3

Table II-7: Data Scalar Selection

Examples Using a Data Scalar

The following examples use kW throughout.

For example 1, the following data is used:

$$\text{Volts} \times \text{amps} = \text{watts}$$

$$480 \text{ volts} \times 100 \text{ amps} = 48,000 \text{ watts}$$

$$\text{Watts} \times 3 = \text{system watts}$$

$$48,000 \text{ watts} \times 3 = 144,000 \text{ watts (144kW)}$$

Check the register's value using the data scalar 2 value of .01:

$$\text{System kW} / \text{scalar value} = \text{register value}$$

$$144\text{kW} / .01 = 14,400$$

Since 14,400 is less than 65,535, using data scalar 2 is a good choice for this example.

For example 2, the following data is used:

$$480 \text{ volts} \times 1000 \text{ amps} = 480,000 \text{ watts}$$

$$480,000 \text{ watts} \times 3 = 1,440,000 \text{ watts (1,440kW)}$$

Check the register's value using the data scalar 1 value of .001:

$$1,440\text{kW} / .001 = 1,440,000$$

Since 1,440,000 is greater than 65,535, using data scalar 1 returns an incorrect result. Data scalar 1 is not an appropriate choice.

Reviewing this example using the data scalar 3 value of .1 provides the following result:

$$1,440\text{kW} / .1 = 14,400$$

Since 14,400 is less than 65,535, using data scalar 3 is a good choice for this example.

Values Requiring Two Registers

Additionally, some values (e.g., kilowatt hours) may cover a dynamic range that is larger than 65535 and require two Modbus registers. Any parameter in the **Modbus Register Assignment** tables that shows two registers (identified by the terms MSW (Most Significant Word) and LSW (Least Significant Word)) are examples of this wide-ranging parameter.

To interpret the values contained in these registers, the steps are:

- 1) Multiply the MSW register by 65536.
- 2) Add the result to the value found in the corresponding LSW register.
- 3) Multiply the result by the appropriate scalar value from Table II-6.

For example, assume that System Total True Energy (kWh) is desired and the value of 5013 is read from register 44001 (LSW) and 13 is read from register 44002 (MSW) and that the register 44602 data scalar is set to 3.

To calculate the total kWh recorded:

Multiply the MSW by 65536: $13 \times 65536 = 851968$

Add the LSW: $851968 + 5013 = 856981$

Multiply by the scalar 3 value of 0.1: $856981 \times 0.1 = 85698.1$ kWh

Did You Know?

When reading two register values, ViewPoint automatically calculates the total value.

Comms Setup

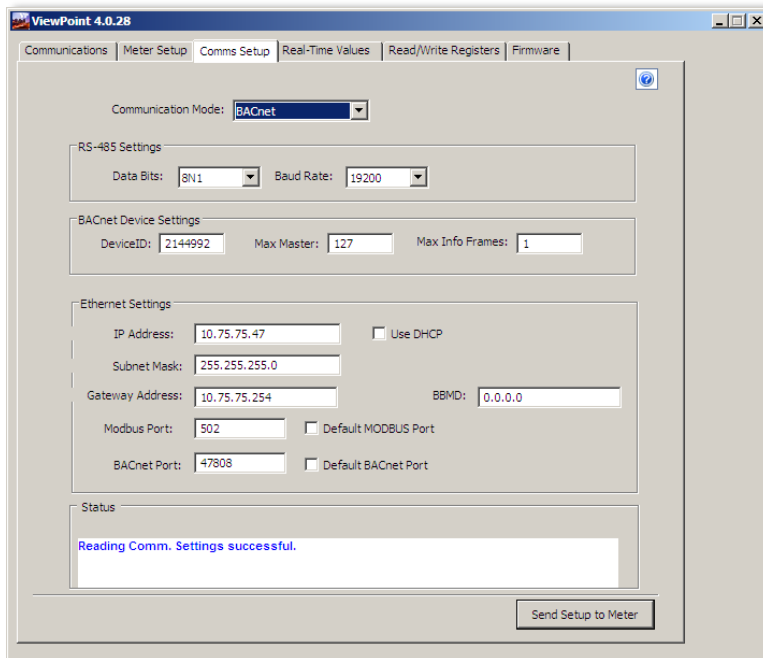

Use this tab to change communication parameters for the meter, such as communication protocols and how those communications are transferred. This screen displays the fields pertinent to your power connection and communication protocol, so if you are connected by RS-485 then only those fields are shown. However, if you are connected with a USB cable all fields are displayed. Changes to these fields override any settings on the Communications tab.

RS-485 SETTINGS

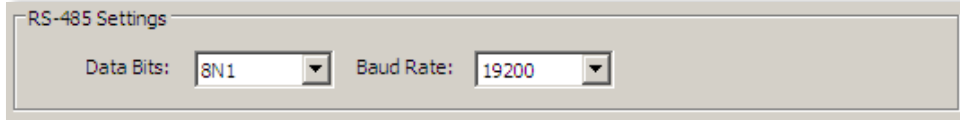

The screenshot shows a dialog box titled "RS-485 Settings". It contains two dropdown menus: "Data Bits" is set to "8N1" and "Baud Rate" is set to "19200".

Change the Data Bits or Baud Rate on the meter by using these fields.

NOTE: You will see the above dialog when you are connected via USB on an Ethernet PowerScout or when connected via an RS-485 unit.

BACNET DEVICE SETTINGS

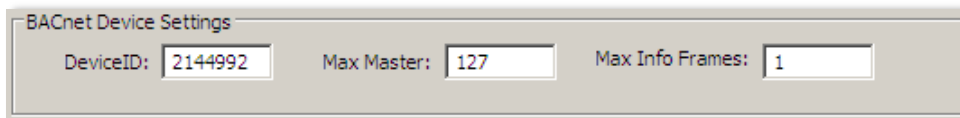

The screenshot shows a dialog box titled "BACnet Device Settings". It contains three text input fields: "DeviceID:" with the value "2144992", "Max Master:" with the value "127", and "Max Info Frames:" with the value "1".

Enter a new value into any field and click **Send Setup to Meter** to update the **Device ID** (meter identification), **Max Master** (# of units on network), or **Max Info Frames** (# of packets sent via MS/TP).

ETHERNET SETTINGS

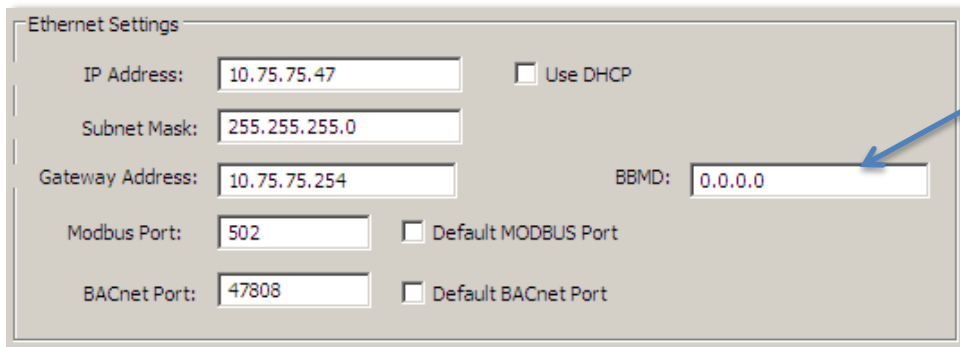

The screenshot shows a dialog box titled "Ethernet Settings". It contains several fields and checkboxes: "IP Address:" (10.75.75.47), "Subnet Mask:" (255.255.255.0), "Gateway Address:" (10.75.75.254), "Modbus Port:" (502), "BACnet Port:" (47808), "Use DHCP" (checkbox), "Default MODBUS Port" (checkbox), and "Default BACnet Port" (checkbox). There is also a "BBMD:" field with the value "0.0.0.0".

To use BBMD: Enter an IP Address or 0.0.0.0 to disable

NOTE: You will see the above dialog only when connected via an Ethernet PowerScout.

Connecting the Ports

Once your communication mode is selected, click **Connect** to establish a connection between the computer and the PowerScout meter.

- When the PowerScout is in the process of connecting to the computer, the Communication Status LED flashes briefly followed by a solid green.
- If the PowerScout cannot connect to the computer, the Communication Status LED flashes red and returns to a solid green. Change the ViewPoint hardware settings and click **Connect** again.

ViewPoint fills the **Device Info** fields when the computer communicates with the PowerScout.

PowerScout meter installation can be verified using the ViewPoint software. Refer to *Using ViewPoint Software* further in this document for more information.

Establishing Communication Protocol

The PowerScout communicates using the BACnet MS/TP or Modbus RTU protocols via the RS-485/Ethernet interface. To establish communication with a **RS-485**, the settings must meet the following requirements:

- The Modbus/BACnet address on the PowerScout and in the ViewPoint software must be set to the same value.
- The PowerScout meter default serial parameters are:

Parameter Defaults	Modbus Settings	BACnet Settings
Baud	9600	76800
Data bits	8	8
Parity	None	None
Stop Bit	1	1

Table II-8: Serial Communication Settings

The supported baud rates include 9600, 19200, 38400, 57600 (Modbus only), 76800, and 115200 (Modbus only).

NOTE: The baud rate on the user interface (ViewPoint) must match the PowerScout setting. If these settings differ, the PowerScout cannot communicate. There are no baud rate settings when connected via Ethernet.

SWITCHING BETWEEN BACNET AND MODBUS MODE

Changing Communication Mode

Using ViewPoint

Using the Comms Setup tab in ViewPoint is the preferred way to change communications modes between Modbus and BACnet.

Note: The baud rate and serial settings may need to change between Modbus and BACnet. Setting address switches to “00” will set the unit in Modbus protocol, 9600 baud rate.

If communication fails, see the section *Changing Baud Rate or Communication Mode using Address Switches (between Modbus and BACnet)* on the next page.

Changing the PowerScout from Modbus to BACnet mode:

- 1) Connect to the PowerScout using ViewPoint.
- 2) Go to the Read/Write Registers tab in ViewPoint.
- 3) Enter **44612** into the **Register** field or click **List** to select from the Register Picker List.
- 4) In the **Value** field, enter **1833** to change to BACnet mode.
- 5) Click **OK**.

The status should say "Writing Value..."

Return to the Communications tab and connect.

Changing the PowerScout from BACnet to Modbus mode:

- 1) Connect to the PowerScout using ViewPoint.
- 2) Go to the Read/Set Objects tab in ViewPoint.
- 3) Enter **10190** into the **Object** field or click **List** to select from the Object Picker List.
- 4) In the **Value** field, enter **375** to change to Modbus mode.
- 5) Click **OK**.

The status should say "Writing Value..."

Return to the Communications tab and connect.

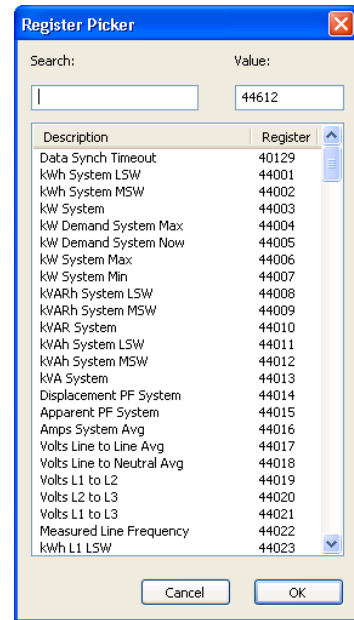

Changing Baud Rate or Communication Mode Using Address Switches (between Modbus and BACnet)

This procedure is only required if *Changing Communication Mode using ViewPoint (between Modbus and BACnet)* fails and the PowerScout needs to be returned to a particular communications protocol and baud rate.

- 1) Power down the PowerScout (disconnect all voltage leads or the USB cable).
- 2) Set the rotary Address switches to “F” and “F”.
- 3) Power up the PowerScout (connect the black & red voltage leads to power or connect the USB cable).
- 4) Set LSB to one of the following communication modes:

LSB Address Switch	Communication Mode	RS-485 LED	COM LED
1	Modbus*	Red On	Off
2	BACnet	Red On	Red On

*Factory Default

Figure II-9: LSB Communication Mode

- 5) Next set MSB to one of the following baud rates:

MSB Address Switch	Baud Rate	PhaseChek LED CT1	PhaseChek LED CT2	PhaseChek LED CT3
1	9600*	Off	Off	Green
2	19200	Off	Green	Off
3	38400	Off	Green	Green
4	57600 (Modbus only)	Green	Off	Off
5	76800	Green	Off	Green
6	115200 (Modbus only)	Green	Green	Off

*Factory Default

Figure II-10: MSB Baud Rate

After powering up the PowerScout 3037, you will have 10 seconds to make changes. However, every time a rotary switch is changed, the 10 second timer resets. After 10 seconds of no switch action, the settings take effect and the switches revert to the Modbus Address selector if in Modbus mode or MAC address if in BACnet mode.

FAILSAFE: If all address switches are “0,” the meter is placed in Modbus mode at 9600 baud rate. Communication registers can be modified for baud rate and for mode.

FIELD INSTALLATION

Once your PowerScout meter is set up for the desired communication method and protocol, it's ready to install out in the field.

Mounting a PowerScout 3037



WARNING! Remove the meter from all sources of voltage before mounting.

PowerScout meters must be installed in an approved electrical panel or enclosure using proper installation practices according to the local electrical codes.

- To mount the PowerScout 3037, use the two tabs provided at both ends of the case. Securely mount the PowerScout near a dedicated circuit disconnect breaker.

Handle with care

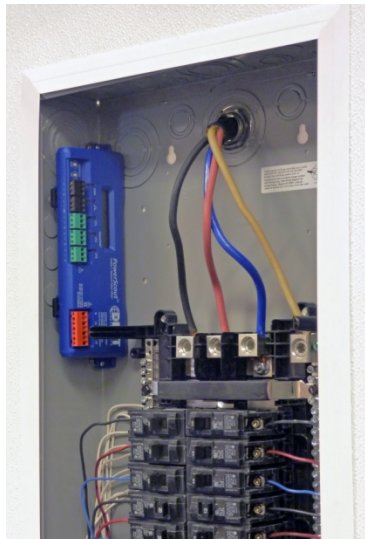

PowerScout 3037 mounted
within electrical panel



Mounting tabs,
located on each end
of meter case

- The PowerScout 3037 can also be mounted on a 35 mm width DIN rail.

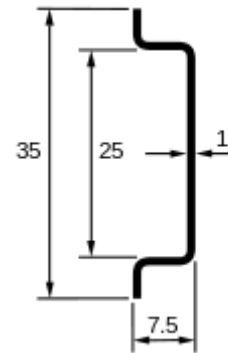

Top hat rail EN 50022

Wiring Connections on the PowerScout 3037



High voltage MAY BE PRESENT. Risk of electric shock. Life threatening voltages may be present. Qualified personnel only.



Haute tension peut être présente. Risque de choc électrique. Tensions dangereuses peuvent être présentes. Personnel qualifié uniquement.

PowerScout 3037 meters have the following connections:

- USB port for powering the meter and communicating during setup, a three-wire connector for the RS-485 BACnet/Modbus link, and an Ethernet port (optional).
- Digital output port. The port can be used to output kWh, kVARh, or kVAh pulses to external devices, or to toggle on and off to control a remote device or relay.
- Three CT inputs.
- Four voltage connections. Voltage leads are customer supplied. PowerScout meters are self-powered from L1 and L2.

Completing the Field Installation

Follow these steps to complete the field installation of your PowerScout meter:

- Connect whatever communications cable you are using to the building network.
- Connect your pulse output, if used. The port can be used to output kWh, kVARh, or kVAh pulses to external devices, or to toggle on and off to control a remote device or relay. See *Using the Pulse Output Port Function*.
- Connect the CTs. See *Wiring CTs*.
- Connect the voltage and power the meter. See *Connecting Voltage*.

Using the Pulse Output Port Function

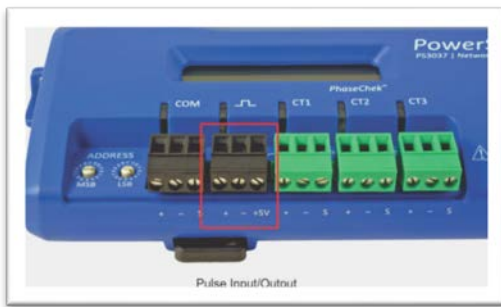

Pulse output is used to generate pulses for external devices such as data loggers that can accept pulses but do not have BACnet or Modbus capability. The PowerScout 3037 can generate pulses based on accumulated value(s) such as system kWh, system kVARh, and system kVAh. When a pulse is generated by the meter, the pulse LED will briefly flash, otherwise it will remain dark.

When in Modbus, the pulse output is scaled by the Modbus data scalar register 44602. When in BACnet, the pulse output is scaled by the CT Pulse Scalar object 12030. The pulse scalar table is the same as the Modbus data scalar table. For example, when the data scalar is set to 3, each pulse will represent .1kWh, .1kVAh and .1kVARh.

Data Scalar	Pulse Scalar Value		
	kWh	kVAh	kVARh
0	.00001	.00001	.00001
1	.001	.001	.001
2	.01	.01	.01
3	.1	.1	.1
4	1	1	1
5	10	10	10
≥6	100	100	100

Table III-1: Pulse Scalar Values

For system pulse output:

- kWh pulse output—write **44001** into the pulse output configuration object.
- kVAh pulse output—write **44011** into the pulse output configuration object.
- kVARh pulse output—write **44008** into the pulse output configuration object.

MODBUS OUTPUT PORT REGISTERS

Modbus Register	Offset	Register Name	Detailed Description
44402	4401/5301	Port 1 output control when used as an on/off—open/closed switch	0 = output LOW (closed) 1 = output HIGH (open) [default] Register 45110 must = 0 to use
45110	5109/5309	Digital Port 1 Configuration Turns pulses on/off	0 = No pulses, Port may be used as an on/off—open/closed switch 44001 = System kWh pulses 44008 = System kVARh pulses 44011 = System kVAh pulses
45111	5110/5310	Port 1 pulse output relay type	0 = normally open (HIGH) 1 = normally closed (LOW)

Table III-2: Modbus Digital Port Pulse Output

BACNET OUTPUT PORT OBJECTS

Refer to the following two tables to configure the PowerScout output port when using the BACnet protocol.



Object Identifier	Object Name	Detailed Description
13020	Port 1 output control when used as an on/off—open/closed switch	0 = output LOW (closed) 1 = output HIGH (open) [default] Object 13100 present value must = 0 to use
13100	Digital Port 1 Configuration Turns pulses on/off	0 = No pulses, Port may be used as an on/off—open/closed switch 44001 = System kWh pulses 44008 = System kVARh pulses 44011 = System kVAh pulses
13110	Port 1 pulse output relay type	0 = normally open (HIGH) 1 = normally closed (LOW)

Table III-3: BACnet Digital Port 1 Pulse Output

Wiring CTs

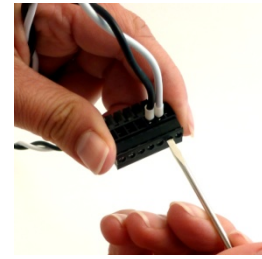
- 1) Insert the CT wires into the connector/s. See the following CT Type Wiring Connections table for the correct wiring configuration.

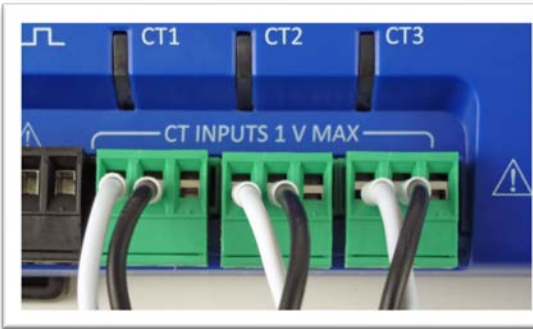
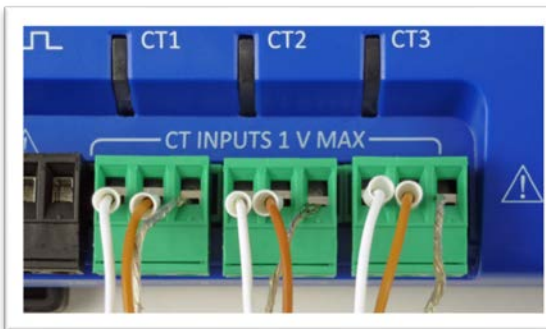

CT Type Wiring Connections	
 <p>Split-Core *2 wire (+, -)</p>	 <p>RōCoil *3-wire (+, -, shield)</p>
PowerScout 3037	<div style="display: flex; justify-content: space-around;"> <div style="text-align: center;">  </div> <div style="text-align: center;">  </div> </div>

- 1) Attach the CTs onto the PowerScout connections labeled CT 1, CT 2 and CT 3.
- 2) Place the CTs on the phase wires of the load to be monitored and corresponding to the phase of the voltage leads. The CT labeled CT 1 must be placed on L1 phase voltage wire, CT 2 must be on the L2 voltage and CT 3 on the L3 voltage. Refer to *PhaseChek*™ later in this section for information about the CT LEDs and verifying the CT installation.

CONNECTING SPLIT-CORE STYLE MILLIVOLT CTs TO A LOAD

- 1) Open the CT by holding on to the removable leg and pulling it apart.



- 2) Connect CT around the load conductor to be measured. Make sure the maximum current of the conductor does not exceed the maximum CT rating listed on the CT data sheet.

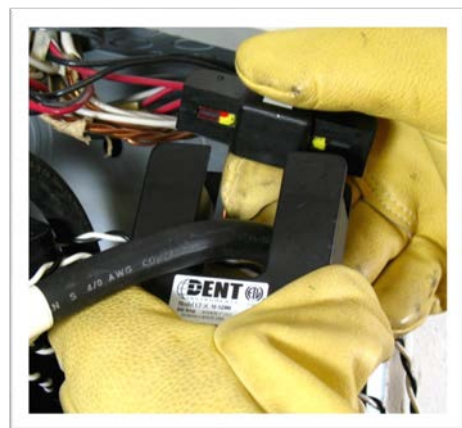

- 3) Carefully re-connect the removable leg while ensuring the CT core alignment matches. The conductor should be in the inside of the CT window.
- 4) Repeat Steps 1-3 if you are using more than one CT.

- 5) Connect the **white wire** on the CT to the **positive terminal** on the measuring device.
- 6) Connect the **black wire** on the CT to the **negative terminal** on the measuring device.

DID YOU KNOW? Correct orientation of a CT is required to ensure proper measurement. If an arrow is shown on the CT label, it should be pointed toward the load. Otherwise, use the instructions printed on the CT.



CONNECTING RōCOIL CTs TO A LOAD

To install the RōCoil CT to the conductor(s):

- 1) Open the CT by squeezing the connector latch and pulling it apart.
- 2) Connect the CT around the load conductor to be measured. Orient the CT so that the arrow on the CT case points towards the load. Make sure the maximum current of the conductor does not exceed 5,000 amps.
- 3) Push the connector back together with the conductor within the loop of the CT.



Repeat the above three steps if you are using more than one RōCoil CT.

To connect the CTs wires to the terminals on the PowerScout:

- 1) Connect the CTs brown wire to the negative terminal on the connector. See photo.
- 2) Connect the CTs white wire to the positive terminal on the connector.
- 3) Connect the bare shield wire from the RōCoil to the “S” shield terminal that is part of the connector. This reduces interference and improves accuracy of the CT.

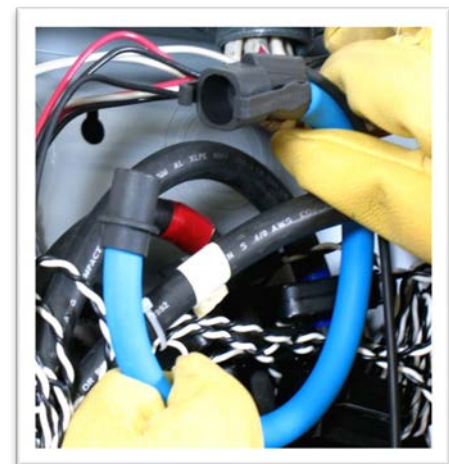

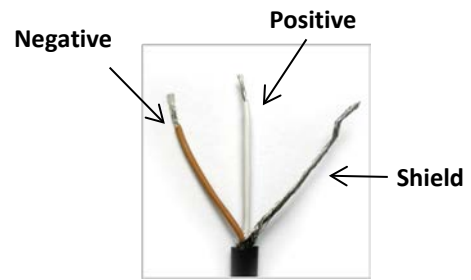
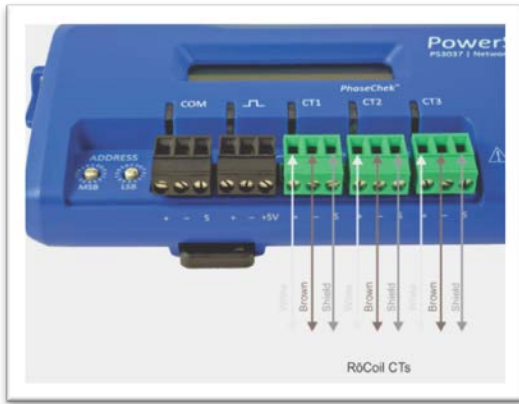

Connecting R0Coil CTs



PowerScout 3037 w/R0Coil CTs
attached to load

CT WIRE LEAD POLARITY

CT Type	CT Lead +	CT Lead -
Rogowski (RōCoil)*	White	Brown
Split Core mV	White	Black
Clamp On mV	Red	Black

Table III-4: CT Polarity

NOTE: The directionality for Rogowski CTs is the arrow points toward the load (e.g. motor).

* RōCoils have a shield wire which must be connected to the meter. This reduces interference and improves accuracy of the CT.

Connecting Voltage

- 1) Connect the voltage leads (L1, L2, L3, and N, as necessary) to the meter. A voltage lead of **14 AWG THHN Minimum 600VAC rating** (or equivalent in order to maintain 600VAC safety rating of the device) is required.
- 2) Connect the leads to the circuit breaker.
 - a) Refer to the wiring diagrams in for wiring connection specifics. Follow local electrical codes during this installation.
 - b) **IMPORTANT:** Verify the breaker is marked as the disconnect breaker for the meter.

NOTE: Refer to the Safety Summary in the Introduction section for information on DC voltage connections.

DID YOU KNOW? The PowerScout is rated for 600V Over-Voltage Category III. Cat III is for measurements performed in the building. Examples are measurements on distribution boards, circuit-breakers, wiring including cables, bus bars, junction boxes, switches, and socket outlets in a fixed installation, and equipment for industrial use. Other equipment could include stationary motors with a permanent connection to the fixed installation.



POWERING THE METER

Connect the PowerScout meter **14 AWG THHN Minimum 600VAC rating** (or equivalent in order to maintain 600VAC safety rating of the device) voltage leads as close as possible to a building-installed, dedicated circuit disconnect breaker. Mark the breaker as the “disconnect” for the PowerScout. Refer to the wiring diagrams for specifics of the wiring connections.

Follow local electrical codes during this installation.

PowerScout meters are self-powered from the L1 and L2 lines. When 80–600VAC or DC is placed across the L1 and L2 wires, the three phasing LEDs begin to flash in sequence.

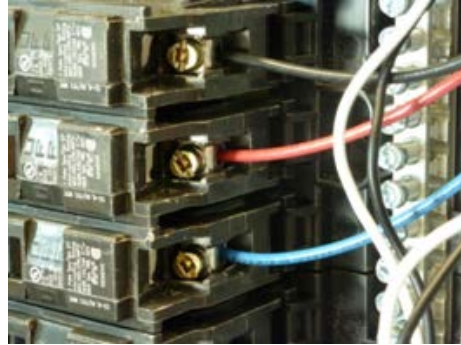

POWERSCOUT SINGLE-PHASE CONNECTIONS

The PowerScout meter can be used to monitor single-phase loads. There are several guidelines to keep in mind about this type of connection:

- 1) The PowerScout is powered from a potential between L1 and L2. This can be phase-to-phase (230V) or phase-to-neutral (115V). With a single-phase 230V panel, the L1 and L2 voltage leads are connected between the L1 and L2 voltage sources. With a 115V circuit, the L1 voltage lead is connected to the L1 “hot lead,” and the L2 voltage lead is connected to neutral.
- 2) Each CT must be paired with the correct voltage source. The current and voltage need to be in-phase for accurate measurements. For instance, CT 1 would monitor branch circuit supplied by voltage source L1, and so on.
- 3) The neutral must be connected because the PowerScout uses line-to-neutral measurements for all calculations.

A Typical 230V Single-Phase Panel Setup (US Wire Colors)

Connect the Black L1 voltage lead to Voltage L1, Red L2 voltage lead to L2 voltage, White Neutral voltage lead to neutral. CT1 would monitor L1 loads and CT2 would monitor L2 loads. Based on the above guidelines, CT3 can be used if the Blue L3 voltage lead is connected to either L1 or L2. As long as voltage lead L3 and CT3 are in-phase, the PowerScout meter will provide correct kW readings. If the Blue L3 voltage lead was connected to L2 voltage source, then CT3 could monitor any L2 branch circuit. Or, if the Blue L3 voltage lead was connected to L1 voltage source, then CT3 could monitor any L1 branch circuit.

A Typical 115V Single-Phase Panel Setup

Connect the Black L1 voltage lead to Voltage L1 (hot), Red L2 voltage lead to Neutral, and White N voltage lead to neutral. CT1 would monitor the L1 load. CT3 can be used if the Blue L3 voltage lead is connected to L1. CT3 could then monitor any L1 branch circuit.

System Values

System values are the sum of L1 + L2 + L3 measurements. System values may not be meaningful since two different devices or loads can be monitored by a single PowerScout element.

When paired with the right voltage phase, each CT provides individual kW/kWh readings for that CT channel.

PowerScout 3037 Wiring Diagrams

THREE-WIRE DELTA

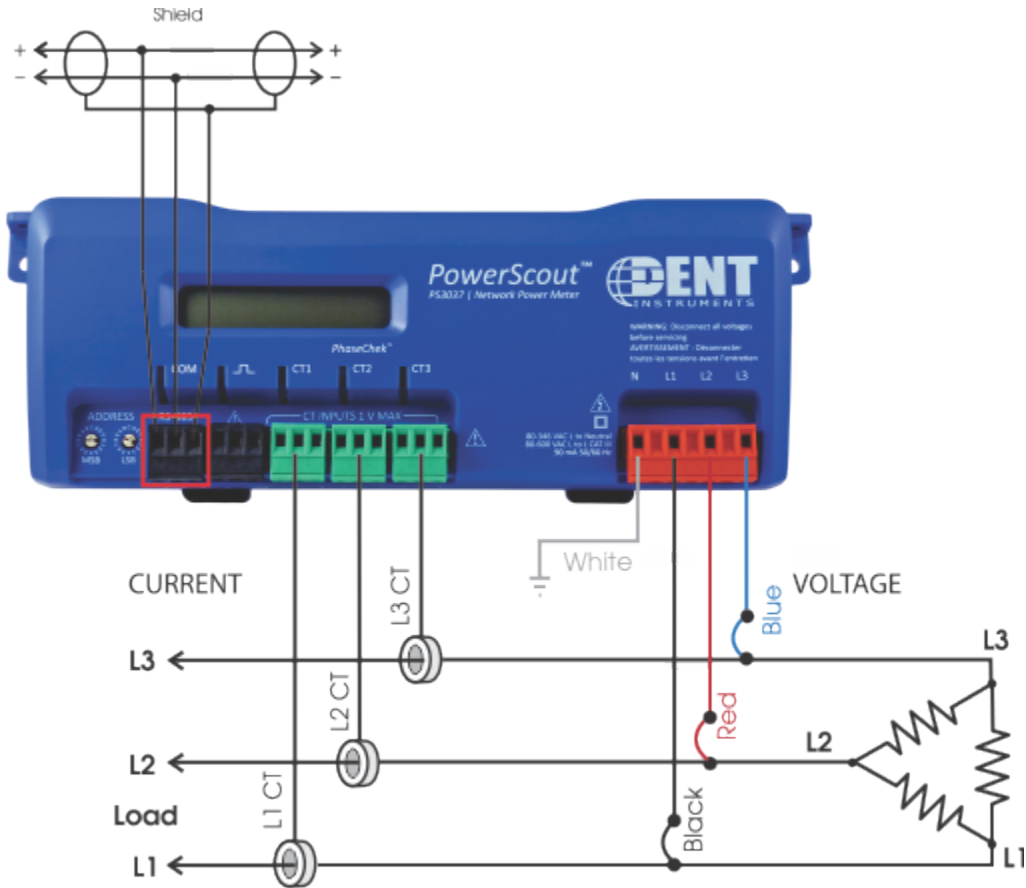

Use a Service Type **0** (zero) value for BACnet Object 12080 or a **0** (zero) value for Modbus Register 44607 on this wire configuration. DENT Instruments recommends using the 3 CT Method (WYE) for delta loads.

FOUR-WIRE WYE

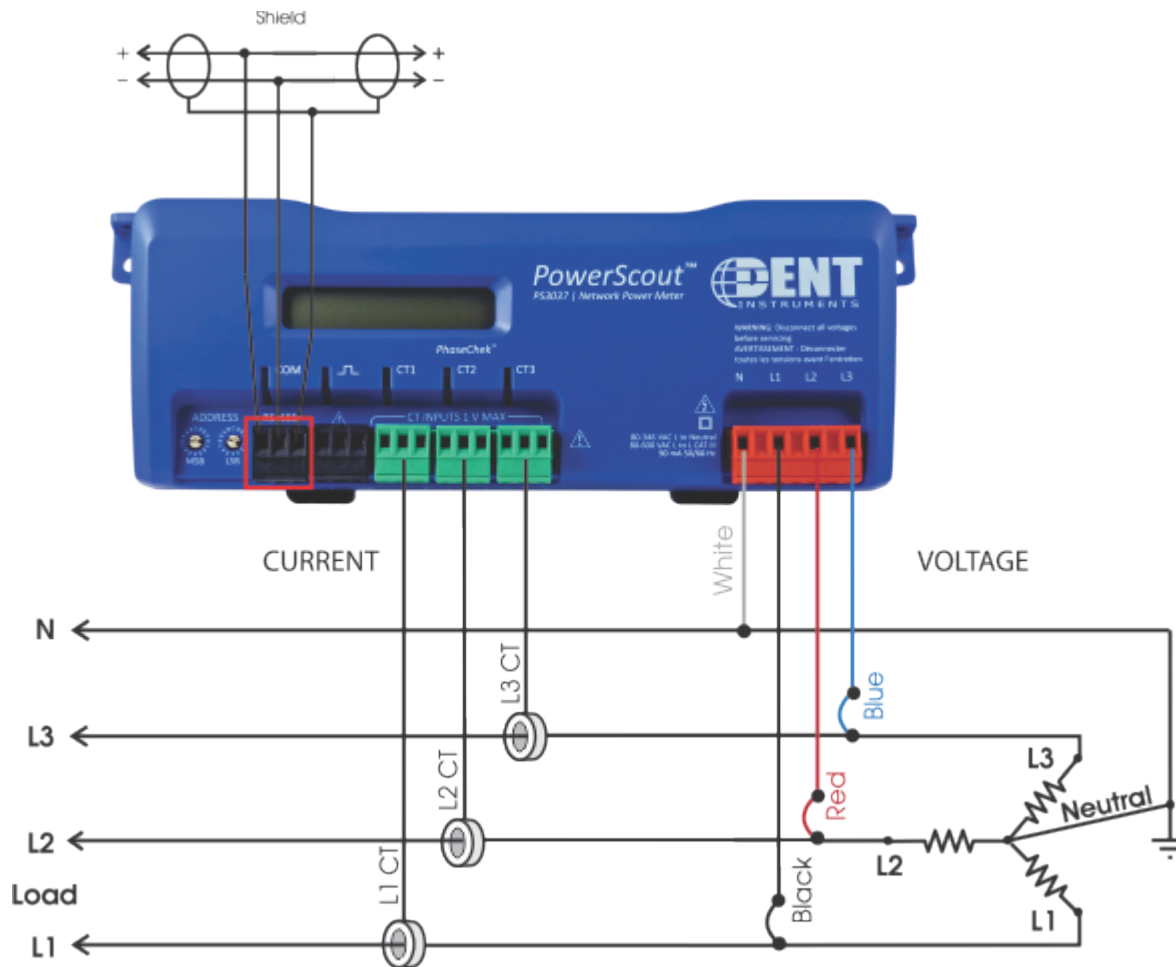

Use a Service Type **0** (zero) value for BACnet Object 12080 or a **0** (zero) value for Modbus Register 44607 on this wire configuration.

TWO-WIRE SINGLE PHASE

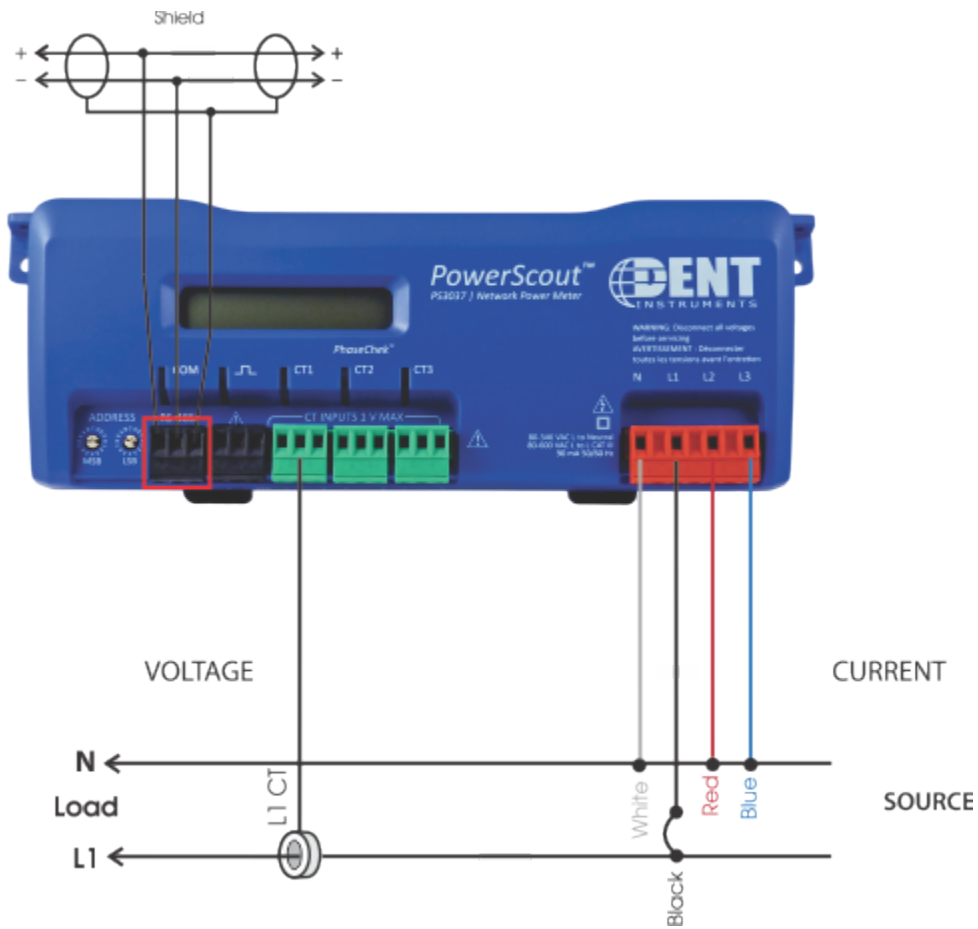

Use a Service Type **0** (zero) value for BACnet Object 12080 or a **0** (zero) value for Modbus Register 44607 on this wire configuration.

THREE-WIRE SINGLE PHASE

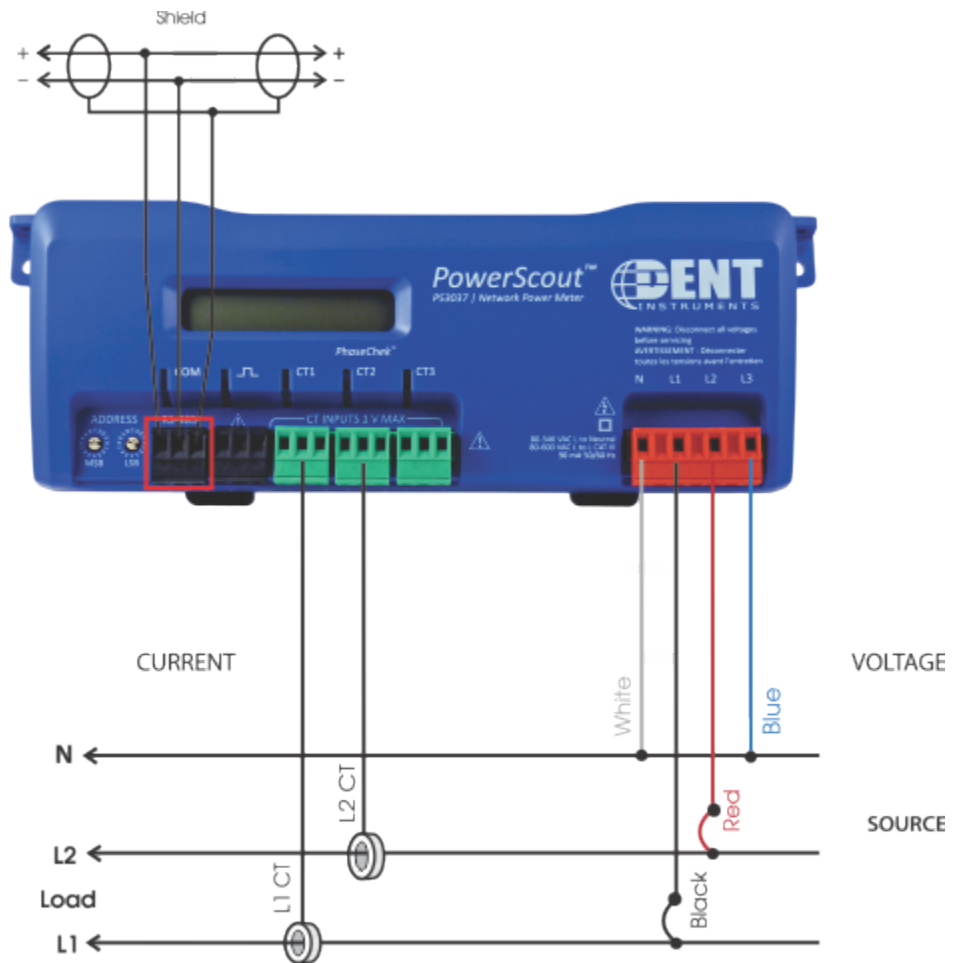

Use a Service Type **0** (zero) value for BACnet Object 12080 or a **0** (zero) value for Modbus Register 44607 on this wire configuration.

Verifying Installation with PhaseChek

PhaseChek¹ is a unique feature of the PowerScout series instruments that simplifies installation by ensuring proper CT orientation and avoiding faulty data collection.

Verifying the PowerScout Meter Setup Using the LEDs

The PowerScout 3037 uses three bi-color PhaseChek LEDs. These LEDs provide the following information:

- All LEDs are green—the system power factor is greater than 0.55 and the CTs are properly placed on the corresponding voltage phases.
- Any one LED is red—there is a phasing connection error.
- Two LEDs are red and one is green—two CTs are reversed.
- All three LEDs are red—all CTs are incorrectly connected.

DID YOU KNOW? If the total system power factor is less than 0.55, the LEDs will be red even if connected properly. This situation is rare but could occur if, for example, the load to be monitored is a lightly loaded electric motor where it is common for the power factor to be less than 0.55 and the corresponding LEDs will be red.

The following table describes the PhaseChek error conditions and the appropriate correction.

PhaseChek Error Table

CT1	CT2	CT3	Error Description	Correction
●	●	●	Setup is correct and the system power factor is greater than 0.55. -or- All CTs are disconnected.	Connect the CTs.
●	●	●	All CTs are incorrectly connected, -or- The system power factor is less than 0.55.	Rotate the CT connections by one position by move CT 1 to CT 2, CT 2 to CT 3 and CT 3 to CT 1, until all LEDs are green. The system power factor is less than 0.55 but the CTs are connected properly indicating a light load.

¹ Patent No. 7,612,552. U.S. Patent and Trademark Office.

CT1	CT2	CT3	Error Description	Correction
●	●	●	CT 2 and CT 3 are reversed.	Switch the position of the CTs flashing red.
●	●	●	CT 1 and CT 2 are reversed.	Switch the position of the CTs flashing red.
●	●	●	CT 1 is swapped with either CT 2 or CT 3.	Switch CT 1 with CT 2. -or- Switch CT 1 with CT 3.
●	●	●	CT 2 is swapped with either CT 1 or CT 3.	Switch CT 2 with CT 1. -or- Switch CT 2 with CT 3.
●	●	●	CT 3 is swapped with either CT 1 or CT 2.	Switch CT 3 with CT 1. -or- Switch CT 3 with CT 2.
●	●	●	CT 1 and CT 3 are reversed.	Switch the position of the CTs flashing red.

Table III-5: PhaseChek LED Error Resolution

Verifying Installation with the ViewPoint Software

In addition to verifying your connections with PhaseChek, you can also use the ViewPoint software to check connections. Any computer running ViewPoint software, whether a laptop connected directly to the meter, a smart phone, or a PC connected to the network can bring up the software and learn information about the connection, the communication protocols, meter setup, real-time values, and firmware version.

REAL-TIME VALUES

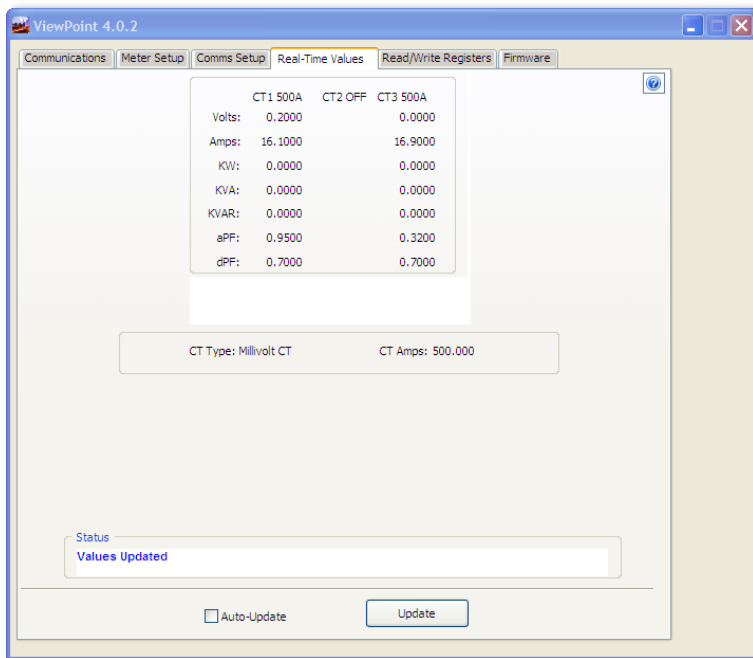

The **Real-Time Values** screen shows current readings to verify the system is configured properly. The tables display the real-time values of Volts, Amps, KW, KVA, KVAR, apparent power factor (aPF), and displacement power factor (dPF) for Phase L1, Phase L2 and Phase L3. This screen also displays the CT Type connected to the PowerScout and the CT Value.

Click **Update** to retrieve the values from the PowerScout.

-or-

Select the **Auto-Update** checkbox to automatically update approximately every 20 seconds.

Using Real-Time Values to Verify Setup

Values displayed for Volts, Amps, KW, etc., should make sense, meaning the values in the table are relevant for the service being measured. This indicates the PowerScout setup is correct.

It may also be useful to use a handheld amp meter to test the current and compare its readings to the values provided on the **Real-Time Values** screen.

Using the Optional Visual Display to Verify Real-Time Values

If your PS3037 meter has the optional visual display installed you can read real-time values directly from the meter. It has 2 rows of 16 characters along with a push button at one end of the PS3037 that controls the display scroll mode. When the display button is held down for 5 seconds the PS3037 will switch between AUTO CYCLE mode (switch screens every 2 seconds) or MANUAL CYCLE (the button must be pressed to switch screens). This change is saved to non-volatile memory.

When in auto cycle mode, the informational screens change every 2–3 seconds, with real-time values updated every second. The “display” button will stop the cycle until it is pressed again or until 20 seconds is reached. Some information, such as protocol, CT type, volts, amps, kW, pf, etc., is displayed during each cycle. See the *Appendix* for a chart showing complete cycle information.



READ/WRITE REGISTERS—READ/SET OBJECTS

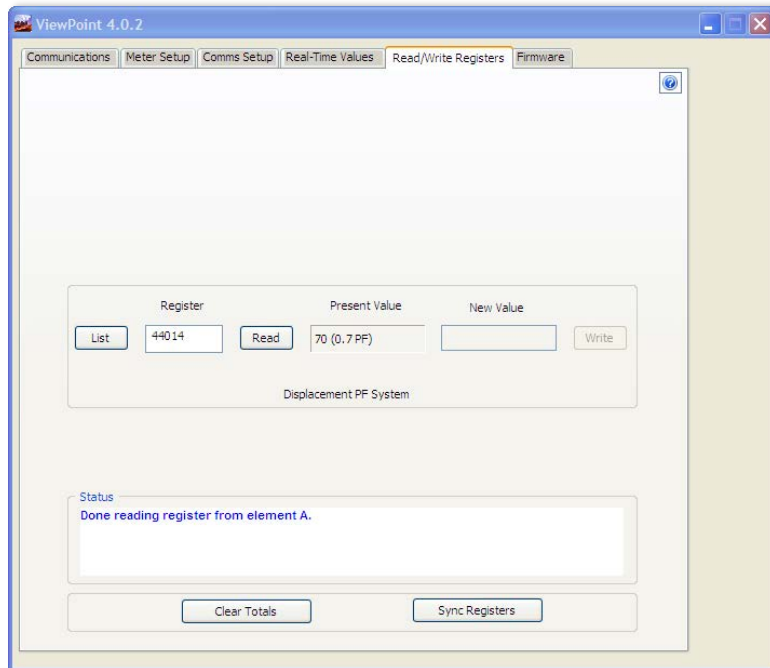

The **Read/Write Registers, Read/Set Objects** screen provides diagnostic and special configuration options, allowing the changing or viewing of the value of any PowerScout register or object. The tab name changes depending on what protocol (Modbus or BACnet) you are using. Its use is not required for a basic setup.

- 1) Enter a register/object address. Refer to the Appendices, *All Things Modbus* or *BACnet Objects* for a list of registers/objects and their descriptions.

-or-

Click **List** to select a register/object from the Register/Object Picker dialog box.

Use the Register/Object Picker dialog box to search for registers/objects by name. The selected value is entered on the Read/Write Registers—Read/Set Objects screen.

- 2) Click **Read** to see the current value.
- 3) Enter a new value in the *New Value* field.
- 4) Click **Write** to change to the new value.
- 5) Click **Clear Totals** to clear accumulated data.

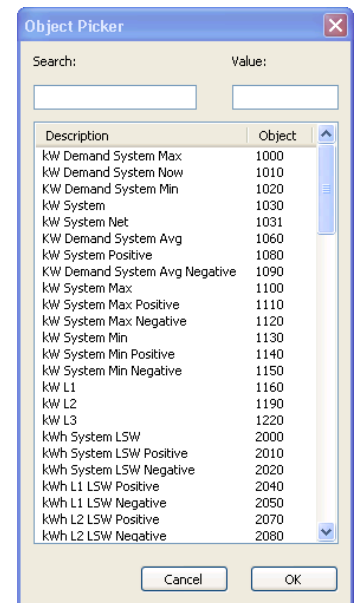

DID YOU KNOW? Accumulated data is registers/objects with a time reference, such as time since reset, kWh, demands, etc.

Resetting BACnet Objects/Modbus Registers

Many of the PowerScout objects/registers are real-time values such as instantaneous watts or power factor. However, some objects are accumulated values such as kWh, kVARh, kVAh and various Peak Demand (kW) values.

To reset all BACnet accumulated objects at once:

- Write to object identifier 10140 “Clear Accumulated Values” current value **1234.0**.

To reset all Modbus accumulated registers at once:

- Write to register 44066 “Clear Accumulated Measurements” current value **1234**.

In ViewPoint, accumulating objects/registers can be reset using the **Read/Set** or **Read/Write** tab.

- Click **Clear Totals** at the bottom of the screen.

See the tables in the Appendices for a list all of the objects/registers available on the PowerScout meters.

FIRMWARE

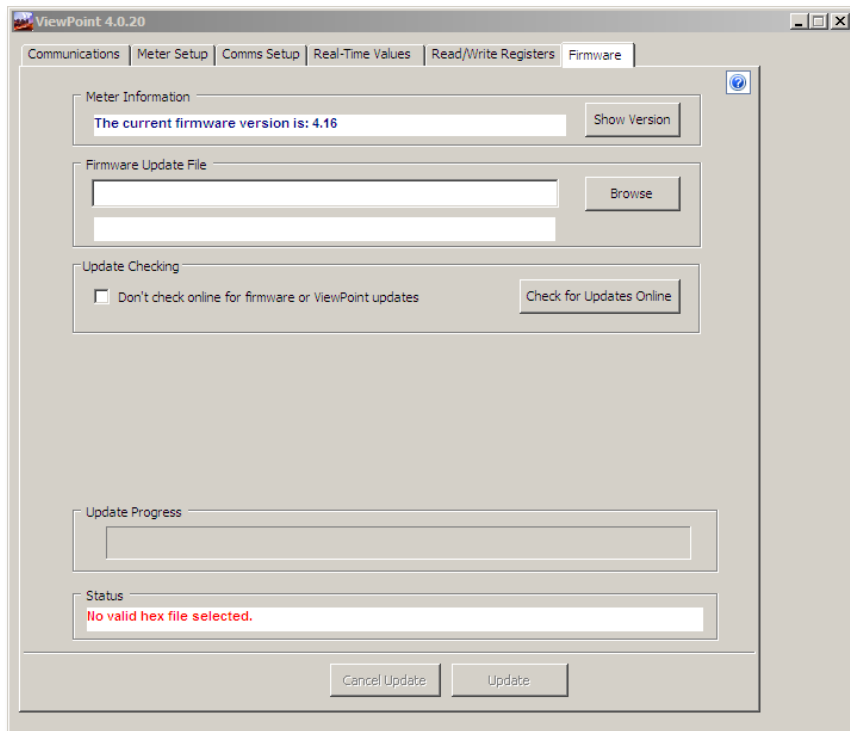

Firmware updates are available from DENT Instruments, contained in a zip file that can be downloaded, unzipped and installed using ViewPoint 4.0 or later. The **Firmware** screen verifies the current firmware version and updates the PowerScout internal firmware. When not connected via USB, updating firmware is only supported in Modbus mode.

If RS-485 communication is used, a baud rate of 9600 will download the firmware to the PowerScout in approximately six minutes. A faster baud rate can be selected to reduce the time by approximately 2.5 minutes. The baud rate is synchronized between ViewPoint and the PowerScout meter by clicking the **Connect** button on the **Communications** tab.

Did You Know? DENT Instruments recommends using 115,200 bps as the baud rate when downloading firmware updates via a RS-485.
NOTE: There are no baud rate settings when connected via USB or Ethernet.

The **Meter Version Update Checking** pop-up screen displays when a meter is connected if your firmware is out of date and Automatic Checking is enabled. If there is a new version available, you are shown the version number of the latest release. Click the **Download** button on the pop-up screen to obtain the latest firmware from the DENT website. Once downloaded, return to the Firmware tab and use the **Browse** command button in Step 2 to select the file and download the new version to the meter.

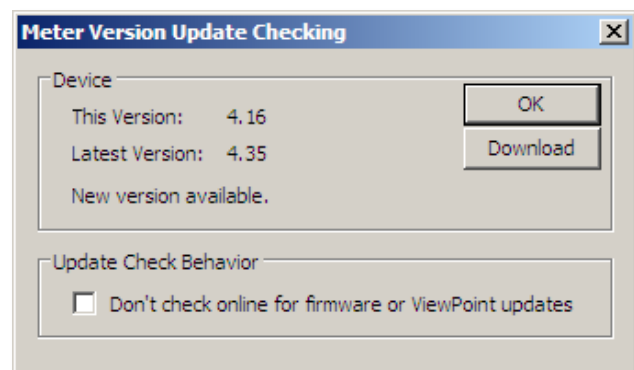

- 1) Click **Show Version** to see which version of firmware is currently loaded in the meter. If a later version of firmware is available, download it from the DENT Instruments website.

Once you have new firmware on your computer, ViewPoint will let you install that firmware for each meter connected of the same model without having to download it again. The firmware is saved wherever your browser saves files by default, or in a folder selected when downloading.

ViewPoint also checks for new versions of the ViewPoint application. When ViewPoint starts, it can automatically contact the DENT Instruments web site to get the latest versions available. It only checks online when running for the first time, or if it has been 7 days since the last check. If there is a new version, the version number of the new release is displayed.

- 2) Click **Browse** to access the *Select a Firmware Update File* dialog box and select the .hex file downloaded from the website.

- 3) Click **Check for Updates Online** to automatically determine if the connected meter has the latest version of the firmware or software.

-or-

Select the ***Don't check online for firmware or ViewPoint updates*** checkbox to disable this feature.

- 4) Click **Update** to send the latest version to the meter.

-or-

Click **Cancel Update** to stop the meter update process.

Did You Know? If the baud rate was changed via an RS-485 for the firmware update, restore the baud rate to its original setting.

ALL THINGS MODBUS

DEVICE REGISTERS

Modbus	Offset	Register	Description
44201	4200	Model Number 1 st 2 bytes	Model Name 10 bytes (ASCII Alpha-Numeric)
44202	4201	Model 2	“
44203	4202	Model 3	“
44204	4203	Model 4	“
44205	4204	Model Number last 2 bytes	“
44206	4205	Serial Number 1 st 2 bytes	Serial Number 10 bytes (ASCII Alpha-Numeric)
44207	4206	Serial 2	“
44208	4207	Serial 3	“
44209	4208	Serial 4	“
44210	4209	Serial Number last 2 bytes	“
44511	4510	Hardware ID	Hardware revisions.
44069	4068	Firmware Major Revision	Major Revision Level (big software releases)
44070	4069	Firmware Minor Revision	Minor Revision Level (small software changes)

CONFIGURATION REGISTERS

Modbus	Offset	Register	Description
40129	0128	Synchronize Register	Multiple PowerScout’s synchronization register
44066	4065	Clear Accumulated Measurements	Writing 1234 resets all 'H' registers, accumulated PowerScout data (kWh, kWh, etc) stored in flash to CAM Default value
44525	4524	CT Type All	Writes same type for all CTs: 1=MilliVolt, 2=Rogowski
44526	4525	Slave ID	!1=DENT, 1=Veris; Sets SLAVE_ID to Veris or DENT

Modbus	Offset	Register	Description
44599	4598	CT Phase Shift All	CT Phase Shift X 100 +/- Writes same value to Registers 50199, 50299, & 50399
44600	4599	CT Integer All	Integer value of all CTs, Writes same value to Registers 50100, 50200, & 50300
44601	4600	CT Decimal All	Decimal value of all CTs, Writes same value to Registers 50100, 50200, & 50300
44602	4601	Data Scalar	A Value of 0-6 that changes the scaling of certain registers
44603	4602	Demand Window Size	Demand window size in minutes; default is 15 min
44604	4603	Volts Multiplier Integer	Multiply volts values by this scalar + Volts Multiplier Decimal/1000. Use with Step-down Transformer. Affects all parameters that use volts (i.e., kW)
44616	4615	Volts Multiplier Decimal	Multiply volts values by (this scalar/1000+Volts Multiplier Integer). Use with Step-down Transformer. Affects all parameters that use volts (i.e., kW)
44605	4604	Amps Multiplier	Multiply amps value by this scalar. For use with x:5A CTs and single let monitoring of a three phase load. Affects all parameters that use amps (i.e, kW)
44606	4605	Communication Setting	Baud: 900=9600, 1900=19200, 3800=38400, 5700=57600, 7600 =76800, 11500=115200 Parity: Add 00 = NO, Add 10 = ODD, Add 20 = EVEN Stop bit: Add 0 = 1 (UART does not permit 0 stop bits), Add 1 = 1, Add 2 = 2 E.g., 901 = 9600 baud, no parity, 1 stop bit
44607	4606	Service Type	A value of 0x0001 configures the meter for DELTA A value of 0x0000 configures the meter for WYE
44609	4608	Set Line Frequency	Line frequency setting for metering: 50=50 Hz, 60=60Hz
44610	4609	Snap Rog Threshold	"Snap to Zero" threshold Rogowski CTs. Register value is:
44611	4610	Snap Volt Threshold	"Snap to Zero" threshold for voltage. Register value is 1x:
44612	4611	Communications Settings	Write 1833 to change to BACnet mode
50100	10099	CT1 Integer	Integer part of CT1
50101	10100	CT1 Decimal	Fractional part of NV_CT1
50125	10124	CT1 Type	Select 1=mV or 2=Rogowski CT1s
50199	10198	CT1 Phase Shift	Phase Shift X 100 +/-

Modbus	Offset	Register	Description
50200	10199	CT2 Integer	Integer part of CT2
50201	10200	CT2 Decimal	Fractional part of NV_CT2
50204	10203	CT2 Voltage Source	Voltage source = Select voltage phase to associate with CT for power and energy calculations. 0= not used,1=L1, 2=L2, 3=L3,4=L1-L2,5=L3-L2, 6=L1-L3, default=L1. Note this register is only active if Service Type (44607) is set to 2 (Single/Independent)
50205	10204	CT2 Amps Multiplier	Amps multiplier= Multiply amps value by this scalar. For use with 5A CTs and single leg monitoring of a three phase load. Affects all parameters that use amps (e.g., kW). Whole numbers only.
50225	10224	CT2 Type	Select 1=mV or 2=Rogowski CT2s
50299	10298	CT2 Phase Shift	Phase Shift X 100 +/-
50300	10299	CT3 Integer	Integer part of CT3
50301	10300	CT3 Decimal	Fractional part of NV_CT3
50325	10324	CT3 Type	Select 1=mV or 2=Rogowski CT3s
50399	10398	CT3 Phase Shift	Phase Shift X 100 +/-

PULSE OUTPUT/INPUT REGISTERS

Modbus	Offset	Register	Description
44402	4401	Port 1 output control when used as an on/off—open/closed switch	0 = output LOW (closed) 1 = output HIGH (open) [default] Register 45110 must = 0 to use
45110	5109	Digital Port 1 Configuration Turns pulses on/off	0 = No pulses, Port may be used as an on/off—open/closed switch 44001 = System kWh pulses 44008 = System kVARh pulses 44011 = System kVAh pulses
45111	5110	Port 1 pulse output relay type	0 = normally open (HIGH) 1 = normally closed (LOW)

ABSOLUTE MEASUREMENT REGISTERS

Offset refers to a base of 40001.

Modbus	Offset	Register	Description * System=sum of three phases
44001	4000	kWh System LSW	System Total True Energy LSW (kWh)
44002	4001	kWh System MSW	System Total True Energy MSW (kWh)
44003	4002	kW System	System Total True Power (kW). Unsigned absolute (ABS) value of ABS (kW L1) + ABS (kW L2) + ABS (kW L3)
44004	4003	kW Demand System Max	System Maximum Demand (peak demand).
44005	4004	kW Demand System Now	Average Power (kW) for most recent demand window
44006	4005	kW System Max	System Maximum Instantaneous kW (Highest kW sample measured)
44007	4006	kW System Min	System Minimum Instantaneous kW (Lowest kW sample measured)
44008	4007	kVARh System LSW	System Total Reactive Energy LSW (kVARh)
44009	4008	kVARh System MSW	System Total Reactive Energy MSW (kVARh)
44010	4009	kVAR System	System Total Reactive Power (kVAR). Unsigned absolute (ABS) value of ABS (kVAR L1) + ABS (kVAR L2) + ABS (kVAR L3)
44011	4010	kVAh System LSW	System Total Apparent Energy LSW (kVAh)
44012	4011	kVAh System MSW	System Total Apparent Energy MSW (kVAh)
44013	4012	kVA System	System Total Apparent Power (kVA). Unsigned WYE = (kVA L1) + (kVA L2) + (kVA L3) Delta = SQRT (kW system ^2 + kVAR system ^2)
44014	4013	Displacement PF System	System Displacement Power Factor (PF). Register is 100x actual value.
44015	4014	Apparent PF System	System Apparent Power Factor (PF). Register is 100x actual value.
44016	4015	Amps System Avg	Average of all phases.

Modbus	Offset	Register	Description * System=sum of three phases
44017	4016	Volts Line to Line Avg	Voltage Line to line (Volts) Average.
44018	4017	Volts Line to Neutral Avg	Voltage Line to neutral (volts) Average.
44019	4018	Volts L1 to L2	Individual Phase to Phase Voltages
44020	4019	Volts L2 to L3	“
44021	4020	Volts L1 to L3	“
44022	4021	Line Frequency	Line Frequency (Hz)
44023	4022	kWh L1 LSW	Individual Phase True Energy LSW (kWh)
44024	4023	kWh L1 MSW	Individual Phase True Energy MSW (kWh)
44025	4024	kWh L2 LSW	“
44026	4025	kWh L2 MSW	“
44027	4026	kWh L3 LSW	“
44028	4027	kWh L3 MSW	“
44029	4028	kW L1	Individual Phase True Powers (kW)
44030	4029	kW L2	“
44031	4030	kW L3	“
44032	4031	kVARh L1 LSW	Individual Phase Reactive Energy LSW (kVARh)
44033	4032	kVARh L1 MSW	Individual Phase Reactive Energy MSW (kVARh)
44034	4033	kVARh L2 LSW	“
44035	4034	kVARh L2 MSW	“
44036	4035	kVARh L3 LSW	“
44037	4036	kVARh L3 MSW	“
44038	4037	kVAR L1	Individual Phase Reactive Powers (kVAR)
44039	4038	kVAR L2	“

Modbus	Offset	Register	Description * System=sum of three phases
44040	4039	kVAR L3	“
44041	4040	kVAh L1 LSW	Individual Phase Apparent Energy LSW (kVAh)
44042	4041	kVAh L1 MSW	Individual Phase Apparent Energy MSW (kVAh)
44043	4042	kVAh L2 LSW	“
44044	4043	kVAh L2 MSW	“
44045	4044	kVAh L3 LSW	“
44046	4045	kVAh L3 MSW	“
44047	4046	kVA L1	Individual Phase Apparent Powers (kVA)
44048	4047	kVA L2	“
44049	4048	kVA L3	“
44050	4049	Displacement PF L1	Individual Phase displacement Power Factor (PF)
44051	4050	Displacement PF L2	“
44052	4051	Displacement PF L3	“
44053	4052	Apparent PF L1	Individual Phase apparent Power Factors (PF)
44054	4053	Apparent PF L2	“
44055	4054	Apparent PF L3	“
44056	4055	Amps L1	Individual Phase Currents (A)
44057	4056	Amps L2	“
44058	4057	Amps L3	“
44059	4058	Volts L1 to Neutral	Individual Phase to Neutral Voltages (V)
44060	4059	Volts L2 to Neutral	“
44061	4060	Volts L3 to Neutral	“
44062	4061	Time Since Reset LSW	Seconds since KWH register was reset. LSW

Modbus	Offset	Register	Description * System=sum of three phases
44063	4062	Time Since Reset MSW	Seconds since KWH register was reset. MSW
44064	4063	Data Tick Counter	Internal sample count (gets cleared every minute): may be used to determine if sample read is a newer sample than last read.
44080	4079	kW System Average	Equals $KWH_SYSTEM_L\&M \div (TimeSinceReset_L\&M \text{ seconds} / 3600 \text{ seconds/Hr})$ (resettable)
44081	4080	kW Demand System Min	System Minimum Demand (kW)
44082	4081	kVA Demand System Max	System Maximum Instantaneous kVA Demand (kVA, resettable). It displays the default value after a CAM until 1 demand window elapses. After a power cycle or CPU reset the value is not reset but it does not update again until 1 demand window elapses.
44083	4082	kVA Demand System Now	System Average kVA Demand For the most recent (current) Demand Window.(resettable) Displays the default value after a CAM or reset, or power cycle. Updates every min thereafter. True demand value takes a demand period to get to actual value. Similar to 44005
44084	4083	kVAR Demand System Max	System Maximum kVAR Demand (kVAR, resettable). It displays the default value after a CAM until 1 demand window elapses. After a power cycle or CPU reset the value is not reset but it does not update again until 1 demand window elapses.

POSITIVE POWER/ENERGY MEASUREMENT REGISTERS

Modbus	Offset	Register	Description * System=sum of three phases
46001	6000	Positive kWh System LSW	System Positive True Energy LSW (kWh, resettable)
46002	6001	Positive kWh System MSW	System Positive True Energy MSW (kWh, resettable)
46003	6002	Positive kW System	System Positive Instantaneous Positive True Power (kW) (net sum of all individual kW's, if sum is negative value=0)
46004	6003	kW Demand System Max	System Maximum Demand (peak demand).
46005	6004	kW Demand System Now	Average Power (kW) for most recent demand window

Modbus	Offset	Register	Description * System=sum of three phases
46006	6005	Positive kW System Max	System Net Highest Instantaneous Positive Draw Since Reset (kW, resettable)
46007	6006	Positive kW System Min	System Net Lowest Instantaneous Positive Draw Since Reset (kW, resettable)
46008	6007	Positive kVARh System LSW	System Net Positive Reactive Energy LSW (kVARh, resettable)
46009	6008	Positive kVARh System MSW	System Net Positive Reactive Energy MSW (kVARh, resettable)
46010	6009	Positive kVAR System	System Net Instantaneous Positive Reactive Power (kVAR) (net sum of all individual kVARs, if sum is negative value=0)
46011	6010	kVAh System LSW	System Apparent Energy, LSW (resettable)
46012	6011	kVAh System MSW	System Apparent Energy, MSW (resettable)
46013	6012	kVA System	System Instantaneous Apparent Power
46014	6013	Positive Displacement PF System	System Positive Displacement Power Factor (dPF); Register is 100x actual value (If the System dPF (44014) is positive, this register will contain that value else it will be zero)
46015	6014	Positive Apparent PF System	System Positive Apparent Power Factor (aPF); Register is 100x actual value (If the System aPF (44015) is positive, this register will contain that value else it will be zero)
46016	6015	Amps System Avg	Average of the current in all phases.
46017	6016	Volts Line to Line Avg	Average of the system line to line voltages.
46018	6017	Volts Line to Neutral Avg	Average of the system line to neutral voltages.

Modbus	Offset	Register	Description * System=sum of three phases
46019	6018	Volts L1 to L2	Individual phase to phase voltages.
46020	6019	Volts L2 to L3	"
46021	6020	Volts L3 to L1	"
46022	6021	Measured Line Frequency	Line frequency x 10 (e.g., 602 = 60.2 Hz). On startup, 20 point averaging array is filled with first frequency read.
46023	6022	Positive kWh L1 LSW	Individual Phase Positive True Energy LSW (kWh, resettable)
46024	6023	Positive kWh L1 MSW	Individual Phase Positive True Energy MSW (kWh, resettable)
46025	6024	Positive kWh L2 LSW	"
46026	6025	Positive kWh L2 MSW	"
46027	6026	Positive kWh L3 LSW	"
46028	6027	Positive kWh L3 MSW	"
46029	6028	Positive kW L1	Individual Phase Instantaneous Positive True Powers (kW)
46030	6029	Positive kW L2	"
46031	6030	Positive kW L3	"
46032	6031	Positive kVARh L1 LSW	Individual Phase Positive Reactive Energy LSW (kVARh, resettable)
46033	6032	Positive kVARh L1 MSW	Individual Phase Positive Reactive Energy MSW (kVARh, resettable)
46034	6033	Positive kVARh L2 LSW	"
46035	6034	Positive kVARh L2 MSW	"

Modbus	Offset	Register	Description * System=sum of three phases
46036	6035	Positive kVARh L3 LSW	"
46037	6036	Positive kVARh L3 MSW	"
46038	6037	Positive kVAR L1	Individual Phase Positive Instantaneous Reactive Powers (kVAR)
46039	6038	Positive kVAR L2	"
46040	6039	Positive kVAR L3	"
46041	6040	kVAh L1 LSW	Individual Phase Apparent Energy LSW (kVAh, resettable)
46042	6041	kVAh L1 MSW	Individual Phase Apparent Energy MSW (kVAh, resettable)
46043	6042	kVAh L2 LSW	"
46044	6043	kVAh L2 MSW	"
46045	6044	kVAh L3 LSW	"
46046	6045	kVAh L3 MSW	"
46047	6046	kVA L1	Individual Phase Instantaneous Apparent Powers (kVA)
46048	6047	kVA L2	"
46049	6048	kVA L3	"
46050	6049	Positive Displacement PF L1	Individual Phase Positive Displacement Power Factors (dPF); Register is 100x actual value (If the Individual dPF (44050) is positive, this register will contain that value else it will be zero)
46051	6050	Positive Displacement PF L2	"
46052	6051	Positive Displacement PF L3	"
46053	6052	Positive Apparent PF L1	Individual Phase Positive Apparent Power Factors (aPF); Register is 100x actual value (If the Individual aPF(44053) is positive, this register will contain that value else it will be zero)

Modbus	Offset	Register	Description * System=sum of three phases
46054	6053	Positive Apparent PF L2	"
46055	6054	Positive Apparent PF L3	"
46056	6055	Amps L1	Individual Phase Instantaneous Currents (A)
46057	6056	Amps L2	"
46058	6057	Amps L3	"
46059	6058	Volts L1 to Neutral	Individual Instantaneous Phase to Neutral Voltages (V)
46060	6059	Volts L2 to Neutral	"
46061	6060	Volts L3 to Neutral	"
46062	6061	Time Since Reset LSW (Seconds)	Seconds since kWh, kVAh, kVARh and associated Demand registers were reset. LSW (resettable)
46063	6062	Time Since Reset MSW (Seconds)	Seconds since CAM. MSW
46080	6079	Positive kW System Average	Equals Positive KWH_SYSTEM_L&M ÷ (TimeSinceReset_L&M seconds /3600 seconds/Hr) (resettable)
46081	6080	kW Demand System Minimum	Min Average power window (kW)
46082	6081	kVA Demand System Maximum	Maximum Instantaneous kVA Demand (kW, resettable).
46083	6082	kVA Demand System Now	System Average kVA Demand for the most recent (current) Demand Window (resettable).
46084	6083	kVAR Demand System Max	System Maximum kVAR Demand (kVAR, resettable). It displays the default value after a CAM until 1 demand window elapses. After a power cycle or CPU reset the value is not reset but it does not update again until 1 demand window elapses.

NEGATIVE POWER/ENERGY MEASUREMENT REGISTERS

Modbus	Offset	Register	Detailed Description * System=sum of three phases
47001	7000	Negative kWh System LSW	System Negative True Energy LSW (kWh, resettable)
47002	7001	Negative kWh System MSW	System Negative True Energy MSW (kWh, resettable)
47003	7002	Negative kW System	System Negative Instantaneous Negative True Power (kW) (net sum of all individual kW, if sum is positive value=0)
47004	7003	kW Demand System Max	System Maximum Demand (peak demand).
47005	7004	kW Demand System Now	Average Power (kW) for most recent demand window
47006	7005	Negative kW System Max	System Net Highest Instantaneous Negative Draw Since Reset (kW, resettable)
47007	7006	Negative kW System Min	System Net Lowest Instantaneous Negative Draw Since Reset (kW, resettable)
47008	7007	Negative kVARh System LSW	System Net Negative Reactive Energy LSW (kVARh, resettable)
47009	7008	Negative kVARh System MSW	System Net Negative Reactive Energy MSW (kVARh, resettable)
47010	7009	Negative kVAR System	System Net Instantaneous Negative Reactive Power (kVAR) (net sum of all individual kVARs, if sum is positive value=0)
47011	7010	kVAh System LSW	System Apparent Energy LSW (kVAh, resettable)
47012	7011	kVAh System MSW	System Apparent Energy MSW (kVAh, resettable)
47013	7012	kVA System	System Instantaneous Apparent Power (kVA)
47014	7013	Negative Displacement PF System	System Negative Displacement Power Factor (dPF); Register is 100x actual value (If the System dPF (44014) is Negative, this register will contain that value else it will be zero)

Modbus	Offset	Register	Detailed Description * System=sum of three phases
47015	7014	Negative Apparent PF System	System Negative Apparent Power Factor (aPF); Register is 100x actual value (If the System aPF (44015) is Negative, this register will contain that value else it will be zero)
47016	7015	Amps System Avg	Average of the current in all phases.
47017	7016	Volts Line to Line Avg	Average of the system line to line voltages.
47018	7017	Volts Line to Neutral Avg	Average of the system line to neutral voltages.
47019	7018	Volts L1 to L2	Individual phase to phase voltages.
47020	7019	Volts L2 to L3	“
47021	7020	Volts L3 to L1	“
47022	7021	Measured Line Frequency	Line frequency x 10 (e.g., 602 = 60.2 Hz). On startup, 20 point averaging array is filled with first frequency read.
47023	7022	Negative kWh L1 LSW	Individual Phase Negative True Energy LSW (kWh, resettable)
47024	7023	Negative kWh L1 MSW	Individual Phase Negative True Energy MSW (kWh, resettable)
47025	7024	Negative kWh L2 LSW	“
47026	7025	Negative kWh L2 MSW	“
47027	7026	Negative kWh L3 LSW	“
47028	7027	Negative kWh L3 MSW	“

Modbus	Offset	Register	Detailed Description * System=sum of three phases
47029	7028	Negative kW L1	Individual Phase Instantaneous Negative True Powers (kW)
47030	7029	Negative kW L2	"
47031	7030	Negative kW L3	"
47032	7031	Negative kVARh L1 LSW	Individual Phase Negative Reactive Energy LSW (kVARh, resettable)
47033	7032	Negative kVARh L1 MSW	Individual Phase Negative Reactive Energy MSW (kVARh, resettable)
47034	7033	Negative kVARh L2 LSW	"
47035	7034	Negative kVARh L2 MSW	"
47036	7035	Negative kVARh L3 LSW	"
47037	7036	Negative kVARh L3 MSW	"
47038	7037	Negative kVAR L1	Individual Phase Negative Instantaneous Reactive Powers (kVAR)
47039	7038	Negative kVAR L2	"
47040	7039	Negative kVAR L3	"
47041	7040	kVAh L1 LSW	Individual Phase Apparent Energy LSW (kVAh, resettable)
47042	7041	kVAh L1 MSW	Individual Phase Apparent Energy MSW (kVAh, resettable)
47043	7042	kVAh L2 LSW	"
47044	7043	kVAh L2 MSW	"
47045	7044	kVAh L3 LSW	"
47046	7045	kVAh L3 MSW	"
47047	7046	kVA L1	Individual Phase Instantaneous Apparent Powers (kVA)
47048	7047	kVA L2	"

Modbus	Offset	Register	Detailed Description * System=sum of three phases
47049	7048	kVA L3	"
47050	7049	Negative Displacement PF L1	Individual Phase Negative Displacement Power Factors (dPF); Register is 100x actual value (If the Individual dPF(44050) is Negative, this register will contain that value else it will be zero)
47051	7050	Negative Displacement PF L2	"
47052	7051	Negative Displacement PF L3	"
47053	7052	Negative Apparent PF L1	Individual Phase Negative Apparent Power Factors (aPF); Register is 100x actual value (If the Individual aPF (44053) is Negative, this register will contain that value else it will be zero)
47054	7053	Negative Apparent PF L2	"
47055	7054	Negative Apparent PF L3	"
47056	7055	Amps L1	Individual Phase Instantaneous Currents (A)
47057	7056	Amps L2	"
47058	7057	Amps L3	"
47059	7058	Volts L1 to Neutral	Individual Instantaneous Phase to Neutral Voltages (V)
47060	7059	Volts L2 to Neutral	"
47061	7060	Volts L3 to Neutral	"
47062	7061	Time Since Reset LSW (Seconds)	Seconds since kWh, kVAh, kVARh and associated Demand registers were reset. LSW (resettable)
47063	7062	Time Since Reset MSW (Seconds)	Seconds since CAM. MSW
47080	7079	Negative kW System Average	Equals Negative KWH_SYSTEM_L&M ÷ (TimeSinceReset_L&M seconds /3600 seconds/Hr) (resettable)
47081	7080	kW Demand System Minimum	Min Average power window (kW)

Modbus	Offset	Register	Detailed Description * System=sum of three phases
47082	7081	kVA Demand System Maximum	Maximum Instantaneous kVA Demand (kW, resettable).
47083	7082	kVA Demand System Now	System Average kVA Demand for the most recent (current) Demand Window (resettable).
47084	7083	kVAR Demand System Max	System Maximum kVAR Demand (kVAR, resettable). It displays the default value after a CAM until 1 demand window elapses. After a power cycle or CPU reset the value is not reset but it does not update again until 1 demand window elapses.

NET MEASUREMENT REGISTERS

Modbus	Offset	Register	Description * System=sum of three phases
44150	4149	KWh System NET LSW	ABS of the NET System Total True Energy LSW (kWh)
44151	4150	KWh System NET MSW	ABS of the NET System Total True Energy MSW (kWh)
44152	4151	KWh L1 NET LSW	ABS of the NET L1 True Energy LSW (kWh)
44153	4152	KWh L1 NET MSW	ABS of the NET L1 True Energy MSW (kWh)
44154	4153	KWh L2 NET LSW	ABS of the NET L2 True Energy LSW (kWh)
44155	4154	KWh L2 NET MSW	ABS of the NET L2 True Energy MSW (kWh)
44156	4155	KWh L3 NET LSW	ABS of the NET L3 True Energy LSW (kWh)
44157	4156	KWh L3 NET MSW	ABS of the NET L3 True Energy MSW (kWh)
46150	6149	KWh System NET POS LSW	Positive of the NET System Total True Energy LSW (kWh)
46151	6150	KWh System NET POS MSW	Positive of the NET System Total True Energy MSW (kWh)
46152	6151	KWh L1 NET POS LSW	Positive of the NET L1 True Energy LSW (kWh)
46153	6152	KWh L1 NET POS MSW	Positive of the NET L1 True Energy MSW (kWh)
46154	6153	KWh L2 NET POS LSW	Positive of the NET L2 True Energy LSW (kWh)

Modbus	Offset	Register	Description * System=sum of three phases
46155	6154	KWh L2 NET POS MSW	Positive of the NET L2 True Energy MSW (kWh)
46156	6155	KWh L3 NET POS LSW	Positive of the NET L3 True Energy LSW (kWh)
46157	6156	KWh L3 NET POS MSW	Positive of the NET L3 True Energy MSW (kWh)
47150	7149	KWh System NET NEG LSW	Negative of the NET System Total True Energy LSW (kWh)
47151	7150	KWh System NET NEG MSW	Negative of the NET System Total True Energy MSW (kWh)
47152	7151	KWh L1 NET NEG LSW	Negative of the NET L1 True Energy LSW (kWh)
47153	7152	KWh L1 NET NEG MSW	Negative of the NET L1 True Energy MSW (kWh)
47154	7153	KWh L2 NET NEG LSW	Negative of the NET L2 True Energy LSW (kWh)
47155	7154	KWh L2 NET NEG MSW	Negative of the NET L2 True Energy MSW (kWh)
47156	7155	KWh L3 NET NEG LSW	Negative of the NET L3 True Energy LSW (kWh)
47157	7156	KWh L3 NET NEG MSW	Negative of the NET L3 True Energy MSW (kWh)

PROTOCOL COMMANDS

The Modbus messaging protocol used for communication follows the Modbus RTU protocol described in this section. Each register read from or written to the PowerScout is a 16-bit unsigned, positive integer value. The PowerScout supports the following commands.

Command Name	Command Number (Hex)	Description
Read Holding Registers	03	Used to read the data values from the PowerScout.
Write Single Register	06	Used to write a single holding register to a PowerScout.
Report Slave ID	11	Used to read information from the identified PowerScout.

Table IV-1: Supported Modbus Commands

The following guidelines are used for these Modbus commands:

- All values are hexadecimal, spaces are not included.
- The address is the value of the address switch on the PowerScout. This must be different for each PowerScout on a single Modbus network.
- The register's high-order and low-order bits are the 16-bit value of a single, or first, register to be accessed for a read or write.
- The CRC is the 16-bit CRC value. Note that the CRC's LSB and MSB are reversed in comparison to those for the registers and data.

Read Holding Registers

This command reads the contents of a contiguous block of holding registers containing data values from the PowerScout. When a read command is received, the PowerScout sends a response that includes the values of the requested registers.

Command Information	Command Layout	Example Command
PowerScout address	nn	37
Command number	03	03
First register to read – high order bits	xx	00
First register to read – low order bits	xx	0C
Number of registers to read – high order bits	xx	00
Number of registers to read – low order bits	xx	01
CRC low order bits	xx	41
CRC high order bits	xx	9F

Table IV-2: Format for Modbus Command 03

Command Example

This command reads from a PowerScout with an address switch setting of 37 hex, reading one byte starting at register offset 0C hex. Note that offset 12 corresponds to Modbus register 40013. All values are hexadecimal.

Example Request Field Name	Command (Hex)	Response Field Name	Response (Hex)
PowerScout address	37	PowerScout address	37
Command	03	Command	03
Starting register address to read– high order bits	00	Byte count	02
Starting register address to read– low order bits	0C	Register value –high order bits	00
Number of registers to read – high order bits	00	Register value – low order bits	00
Number of registers to read – low order bits	01	CRC low order bits	70
CRC low order bits	41	CRC high order bits	40
CRC high order bits	9F		

Table IV-3: Example for Modbus Command 03

Command: 3703000C0001419F

Response: 37030200007040

The response is from the PowerScout at address 37. Two bytes were read from the requested register, 000C. The value of the registers read was 0000. The CRC value was 4070. The number of registers read must be between 1 and 125 inclusive.

DID YOU KNOW? The value sent as the register address in the read and write Modbus commands is not the register listed in the table, instead an abbreviated version is sent. The actual register address sent is the Modbus register value minus 40001. For example, the address sent in the command message for register 40025 is actually 0024 (0018 hexadecimal), and the address sent for register 44062 is actually 4061 (0FDD hexadecimal).

Write Single Register

This command writes to a single holding register of the PowerScout. The normal response is an echo of the request, returned after the register contents are written.

Command Information	Command Layout	Example Command
PowerScout address	nn	37
Command number	06	06
Register to write – high order bits	xx	00
Register to write – low order bits	xx	00
Register value to write – high order bits	xx	00
Register value to write – low order bits	xx	00
CRC low order bits	xx	8C
CRC high order bits	xx	5C

Table IV-4: Format for Modbus Command 06

Example Command

This command writes to a PowerScout with an address switch setting of 37 hex (55 in decimal), writing one byte at register 000C, and writing a value of 00 to clear the KWH registers. The data value of 0 is sent to register 0. Note that offset 0 corresponds to Modbus register 40001. The CRC is 5C8C. All values are hexadecimal.

Example Request Field Name	Command (Hex)	Response Field Name	Response (Hex)
PowerScout address	37	PowerScout address	37
Command number	06	Command number	06
Register to write – high order bits	00	Register written to – high order bits	00
Register to write – low order bits	00	Register written to – low order bits	00
Register value to write – high order bits	00	Register value written – high order bits	00
Register value to write – low order bits	00	Register value written – low order bits	00
CRC low order bits	8C	CRC low order bits	8C
CRC high order bits	5C	CRC high order bits	5C

Table IV-5: Example for Modbus Command 06

Command: 370600000018C5C

Response: 370600000018C5C

The response is from the PowerScout at address 37. One byte was written to at the requested register, 0000. The value written was 0000. The CRC value was 5C8C. An echo of the original command after the contents are written is a valid response.

Error Response

If the first register in this write command is not in the valid range of registers, the PowerScout returns an error message.

Report Slave ID

This command is used to read the description, the current status and other information specific to a remote device. A normal response includes the data contents specific to the device.

Command Information	Command Layout	Example Command
PowerScout address	nn	37
Command number	11	11

Table IV-6: Format for Modbus Command 11 (17 in decimal)

Example Command

Example Request Field Name	Command (Hex)	Response Field Name	Response (Hex)
PowerScout address	37	PowerScout address	37
Command number	11	Command number	11
CRC low order bits	D7	Byte count	
CRC high order bits	8C	Slave ID	
		Run indicator status	
		Additional data	

Table IV-7: Example for Modbus Command 11 (17 in decimal)

Slave ID

The PowerScout uses the following default format for the slave ID:

DENT Instruments PowerScout 3037, Serial Number, FW Rev Major Revision. Minor Revision, Scalar X

Example:

DENT Instruments PowerScout 3037, PS3912001, FW Rev 1.0, Scalar 3

NOTE: See *VERIS H8035/H8036 Emulation* for slave ID structure while in Veris emulation.

ALL THINGS BACNET

The PS3037 supports writable `max_master` and `max_info_frames` properties in the device object for MS/TP networks. For best network performance, the `max_master` should be set to the highest MS/TP MAC address on the network.

The `max_info_frames` does not need to be changed in most installations.

The device ID property of the BACnet device object is also writable. All device IDs on a BACnet network must be unique.

The PS3037 Ethernet version can register as Foreign Devices to a BBMD. **BBMD** stand for *BACnet/IP Broadcast Management Device*. The address also can be written to BACnet object identifiers 14014 (BBMD IP Address LSW) and 14015 (BBMD IP Address MSW).

NOTE: The LSW/MSW are in network order.

For example to set the BBMD server to 192.168.1.100 you would write:

43200 (0xA8C0) to BBMD IP address LSW object identifier 14014

-and-

25601 to (0x6401) to BBMD IP address MSW object Identifier 14015

This sends the register as foreign device packet with a Time to Live (TTL) of 60000 seconds.

To disable BBMD foreign device registration write 0 to both BBMD IP address LSW (14014) and BBMD IP address MSW (14015) or simply write 0.0.0.0 to the BBMD field in the ViewPoint Comms Setup tab.

EDITABLE FIELDS

The **Name**, **Location**, and **Description Notes** fields are all editable with up to 32 characters. If the software you use to edit the fields adds characters to your input, you must include that count as part of your 32 character amount.

METER SPECIFIC OBJECTS

Object Identifier	Name	Description
10080	Hardware ID	Hardware revisions
10090	Features	New features
10150	PowerScout Element ID	Used for ViewPoint to determine which element is being read & total number of elements available. Element index multiplied by 256 + number of elements.

CONFIGURATION OBJECTS

Object Identifier	Name	Description
10020	Data Acquisition Tick	Internal sample count (gets cleared every minute): may be used to determine if sample read is a newer sample than last read.
10140	Clear Accumulated Measurements	Writing 1234 to the present value will reset all the accumulator objects (kWh, kVAh, kVARh)
10190	Communications protocol	Used to change between BACnet and Modbus communications protocols.
12001	CT1 Phase Shift	CT1 phase shift (degrees)
12002	CT2 Phase Shift	CT2 phase shift (degrees)
12003	CT3 Phase Shift	CT3 phase shift (degrees)
12011	CT1 Value	CT1 Value
12012	CT2 Value	CT2 Value
12013	CT3 Value	CT3 Value
12030	CT Pulse Scalar	Changes the scaling of the output pulses
12040	Demand Window	Demand window size in minutes; default is 15 min
12050	Volts Multiplier	Multiply volts values by this scalar. For use with stepdown transformer. Affects all parameters that use volts.
12061	CT1 Amps Multiplier	Multiply CT1 amps values by this scalar. For use with stepdown transformer. Affects all parameters that use amps.
12062	CT2 Amps Multiplier	Multiply CT2 amps values by this scalar. For use with stepdown transformer. Affects all parameters that use amps.
12063	CT3 Amps Multiplier	Multiply CT3 amps values by this scalar. For use with stepdown transformer. Affects all parameters that use amps.
12070	Com Settings	<p>Baud: 900=9600, 1900=19200, 3800=38400, 5700=57600, 7600=76800, 11500=115200</p> <p>Parity: Add 00 = NO, Add 10 = ODD, Add 20 = EVEN</p> <p>Stop bit: Add 0 = 1 (UART does not permit 0 stop bits), Add 1 = 1, Add 2 = 2</p> <p>E.g., 901 = 9600 baud, no parity, 1 stop bit</p>

Object Identifier	Name	Description
12080	Service Type	A value of 1 configures the meter for Delta. A value of 0 configures the meter for Wye.
12090	Line Frequency	Line frequency setting for metering. 50 = 50 Hz, 60 = 60 Hz
12110	Snap Rog Threshold	"Snap to Zero" threshold Rogowski CTs. Register value is:
12120	Snap Volt Threshold	"Snap to Zero" threshold for voltage. Register value is 1x:
12130	CT Type All	Writes same type for all CTs: 1=MilliVolt, 2=Rogowski
12131	CT1 Type	1=MilliVolt, 2=Rogowski
12132	CT2 Type	1=MilliVolt, 2=Rogowski
12133	CT3 Type	1=MilliVolt, 2=Rogowski
12134	CT1 Voltage Source	Individual Phase Voltage Source
12135	CT2 Voltage Source	Individual Phase Voltage Source
12136	CT3 Voltage Source	Individual Phase Voltage Source

PULSE OUTPUT/INPUT OBJECTS

Object Identifier	Name	Description
13020	Port 1 output control when used as an on/off—open/closed switch	0 = output LOW (closed) 1 = output HIGH (open) [default] Object 13100 present value must = 0 to use
13100	Digital Port 1 Configuration Turns pulses on/off	0 = No pulses, Port may be used as an on/off—open/closed switch 44001 = System kWh pulses 44008 = System kVARh pulses 44011 = System kVAh pulses
13110	Port 1 pulse output relay type	0 = normally open (HIGH) 1 = normally closed (LOW)
14014	BBMD IP Address	LSW object identifier
14015	BBMD IP Address	MSW object identifier

ABSOLUTE/NET VALUE MEASUREMENT OBJECTS

System=sum of three phases.

Object Identifier	Name	Description * System=sum of three phases
1000	kW Demand System Maximum	System Maximum Demand (peak demand) (Unsigned/Absolute)
1010	kW Demand System Now	Average Power (kW) for most recent demand window (Unsigned/Absolute)
1020	kW Demand System Minimum	Min Average power window (kW) (Unsigned/Absolute)
1030	kW System	System True Power (kW). Unsigned absolute (ABS) value of ABS (kW L1) + ABS (kW L2) + ABS (kW L3)
1031	kW System Net	System Power (kW) Signed net value of (kW L1) + (kW L2) + (kW L3)
1060	kW System Average	Equals kWh System / (Time Since Reset /3600 seconds/Hr) (resettable)
1100	kW System Maximum	System Highest Instantaneous Draw Since Reset (kW)
1130	kW System Minimum	System Lowest Instantaneous Draw Since Reset (kW, resettable)
1160	kW L1	Individual Phase True Power (kW) (Signed)

Object Identifier	Name	Description * System=sum of three phases
1190	kW L2	"
1220	kW L3	"
2000	kWh System Total	System True Energy (kWh) (Unsigned/Absolute)
2021	kWh System Total Net	System True Energy (kWh) (Net)
2051	kWh L1 Net	Individual Phase True Energy (kWh) (Net)
2081	kWh L2 Net	"
2111	kWh L3 Net	"
3000	Volts Line to Line Average	Voltage Line to line Average
3010	Volts Line to Neutral Average	Voltage Line to neutral Average
3020	Volts L1 to L2	Individual Phase to Phase Voltages
3030	Volts L2 to L3	"
3040	Volts L1 to L3	"
3050	Volts L1 to Neutral	Individual Phase to Neutral Voltages (V)
3060	Volts L2 to Neutral	"
3070	Volts L3 to Neutral	"
4010	Amps System Average	Average of all phases.
4020	Amps L1	Individual Phase Currents (A)
4030	Amps L2	"
4040	Amps L3	"
5000	kVAR System	System Total Reactive Power (kVAR). Unsigned absolute (ABS) value of ABS (kVAR L1) + ABS (kVAR L2) + ABS (kVAR L3)
5001	kVAR System Net	System Total Reactive Power (kVAR). Signed net value of (kVAR L1) + (kVAR L2) + (kVAR L3)
5030	kVAR L1	Individual Phase Reactive Energy LSW (kVARh) (Signed)

Object Identifier	Name	Description * System=sum of three phases
5060	kVAR L2	"
5090	kVAR L3	"
5120	kVAR Demand System Max	System Maximum Instantaneous kVAR Demand (kVA, resettable). It displays the default value after a CAM until 1 demand window elapses. After a power cycle or CPU reset the value is not reset but it does not update again until 1 demand window elapses. (Unsigned/Absolute)
5130	kVAR Demand System Now	Average kVAR demand for most recent window (resettable). Displays the default value after a CAM or reset, or power cycle. Updates every min thereafter. True demand value takes a demand period to get to actual value. (Unsigned/Absolute)
6010	kVARh System	System Total Reactive Energy (Unsigned/Absolute)
7000	kVAh System Total	System Total Apparent Energy (Unsigned/Absolute)
8000	kVA System	System Total Apparent Power (kVA). Unsigned absolute (ABS) value of ABS (kVA L1) + ABS (kVA L2) + ABS (kVA L3)
8001	kVA System Net	System Net Apparent Power (kVA). Signed net value of (kVA L1) + (kVA L2) + (kVA L3)
8010	kVA L1	Individual Phase Apparent Powers (kVA) (signed)
8020	kVA L2	"Sign is set to the sign of the kW
8030	kVA L3	"
8040	kVA Demand System Max	System Maximum Instantaneous kVA Demand (kVA, resettable). It displays the default value after a CAM until 1 demand window elapses. After a power cycle or CPU reset the value is not reset but it does not update again until 1 demand window elapses. (Unsigned/Absolute)
8050	kVA Demand System Now	Average kVA for most recent demand window (resettable). Displays the default value after a CAM or reset, or power cycle. Updates every min thereafter. True demand value takes a demand period to get to actual value. (Unsigned/Absolute)
9000	Displacement PF System	System Total Power Factor (PF) (Signed)
9030	Apparent PF System	System Total Power Factor (PF) (Signed)
9060	Displacement PF L1	Individual Phase displacement Power Factor (PF)

Object Identifier	Name	Description * System=sum of three phases
9090	Displacement PF L2	“
9120	Displacement PF L3	“
9150	Apparent PF L1	Individual Phase apparent Power Factors (PF)
9180	Apparent PF L2	“
9210	Apparent PF L3	“
10000	Measured Line Frequency	Line Frequency (Hz)
10010	Time Since Reset	Seconds since accumulator registers were reset.

POSITIVE POWER/ENERGY MEASUREMENT OBJECTS

Object Identifier	Name	Description * System=sum of three phases
1080	kW System Average Positive	Equals kWh System Positive / (Time Since Reset /3600 seconds/Hr) (resettable) (Signed Net)
1110	kW System Maximum Positive	System Highest Instantaneous Positive Draw Since Reset (kW) (Signed Net)
1140	kW System Minimum Positive	System Lowest Instantaneous Positive Draw Since Reset (kW, resettable)
2010	kWh System Total Positive	System True Energy (kWh) Positive (Signed Net)
2040	kWh L1 Positive	Individual Phase True Energy (kWh) (Signed)
2070	kWh L2 Positive	“
2100	kWh L3 Positive	“
6010	kVARh System	System Total Reactive Energy (Signed Net)
6020	kVARh System Total Positive	System True Energy (kVARh) Positive (Signed Net)
6050	kVARh L1 Positive	Individual Phase Reactive Energy (kVAR) (Signed)
6080	kVARh L2 Positive	“

Object Identifier	Name	Description * System=sum of three phases
6110	kVARh L3 Positive	“
7001	kVAh System Total Positive	System Total Positive Apparent Energy (kVAh) (Signed Net) Accumulates only when kW is positive
7020	kVAh L1 Positive	Individual Phase Apparent Energy (kVAh) (Signed)
7050	kVAh L2 Positive	“
7080	kVAh L3 Positive	“

NEGATIVE POWER/ENERGY MEASUREMENT OBJECTS

Object Identifier	Name	Detailed Description * System=sum of three phases
1090	kW System Average Negative	Equals kWh System Negative / (Time Since Reset /3600 seconds/Hr) (resettable)
1120	kW System Maximum Negative	System Highest Instantaneous Negative Draw Since Reset (kW)
1150	kW System Minimum Negative	System Lowest Instantaneous Negative Draw Since Reset (kW, resettable)
2020	kWh System Total Negative	System True Energy (kWh) Negative (Signed Net)
2050	kWh L1 Negative	Individual Phase True Energy (kWh) (Signed)
2080	kWh L2 Negative	“
2110	kWh L3 Negative	“
6030	kVARh Sys Negative	System Total Reactive Energy (Signed Net)
6060	kVARh L1 Negative	Individual Phase Reactive Energy (kVARh) (Signed)
6090	kVARh L2 Negative	“
6120	kVARh L3 Negative	“
7002	kVAh System Total Negative	System Total Negative Apparent Energy (Signed Net)
7030	kVAh L1 Negative	Individual Phase Apparent Energy (kVAh) (Signed)
7060	kVAh L2 Negative	“
7090	kVAh L3 Negative	“

APPENDICES

Appendix A—Additional Wiring Diagrams

Typically, the PowerScout can be wired using any one of the previous setups found in the PowerScout 3037 Wiring Diagrams. The following are less frequently used configurations and will assist you in properly connecting your PowerScout meter for the desired setup. ALL WIRE COLORS ARE U.S. STANDARD.



WARNING! DO NOT EXCEED 600VAC PHASE TO PHASE CAT III.

When complete, close the enclosure cover, if equipped.



Attention: Ne pas dépasser une phase à 600VAC CAT III.

Une fois terminé, fermer le couvercle, s'il y en a un.



CAUTION: THE POWERSCOUT™ METER SHOULD ONLY BE WIRED BY QUALIFIED PERSONNEL. HAZARDOUS VOLTAGES EXIST.



ATTENTION: LE POWERSCOUT™ ne doit être branché QUE par un personnel qualifié. TENSIONS DANGEREUSES sont présentes.



DANGER! THE UNENCLOSED POWERSCOUT BOARD REQUIRES EXTRA CAUTION WHEN CONNECTING. LIFE THREATENING VOLTAGES EXCEEDING 600 VOLTS MAY EXIST ON THE BOARD. THE RISK OF SERIOUS INJURY OR DEATH SHOULD NOT BE UNDERESTIMATED.



DANGER! LA PLAQUETTE DE CIRCUITS IMPRIMES SANS COUVERCLE EXIGE UN REDOUBLEMENT DE PRUDENCE QUAND ON FAIT LA CONNEXION. LES TENSIONS DEPASSANT 600 VOLTS PEUVENT EXISTER SUR LA PLAQUETTE ET PEUVENT METTRE LA VIE EN DANGER. LE RISQUE DE BLESSURES GRAVES OU DE MORT NE DOIT PAS ETRE SOUS-ESTIME.

2-CT, 3-WIRE DELTA

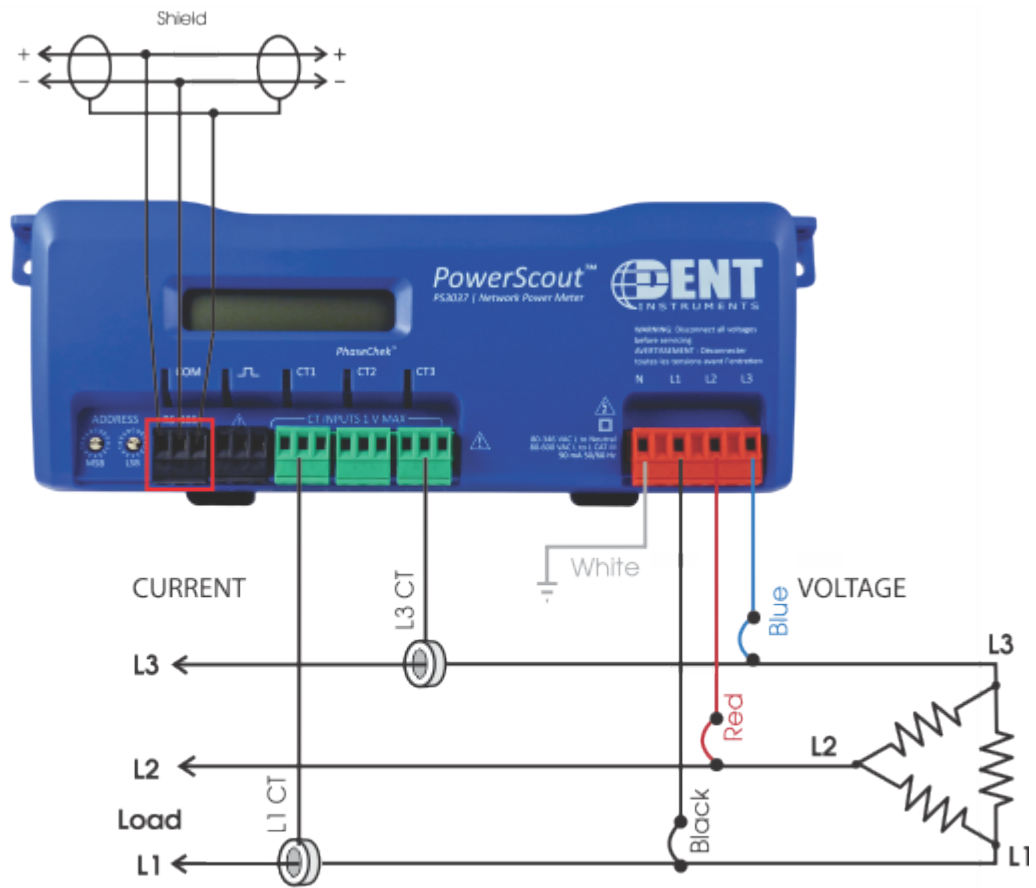

Use a Service Type **1** (one) value for BACnet Object 12080 or a **1** (one) value for Modbus Register 44607 on this wire configuration.

3-PHASE DELTA WITH A "WILD" LEG

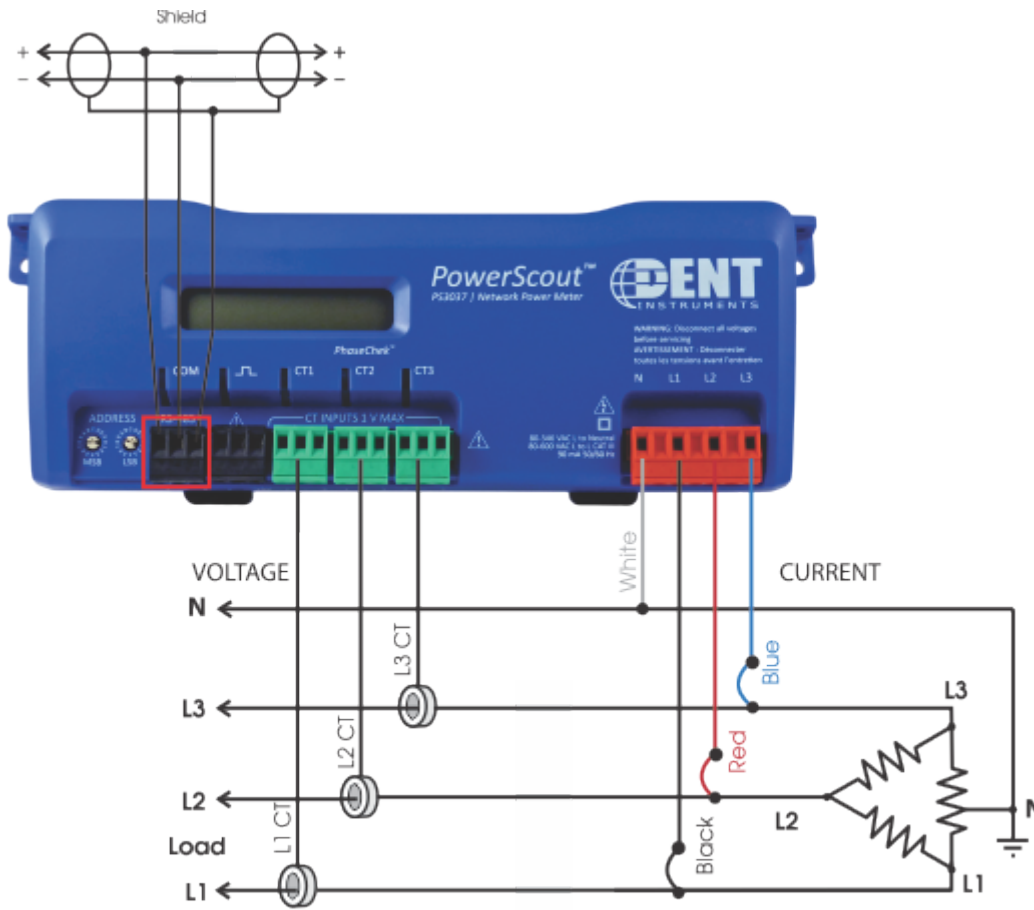

Use a Service Type **0** (zero) value for BACnet Object 12080 or a **0** (zero) value for Modbus Register 44607 on this wire configuration.

Appendix B—Connecting Multiple PowerScouts to an RS-485 Network

This section describes setting up a network with multiple PowerScout instruments using the BACnet or Modbus communication protocol. An RS-485 network can support up to 127 PowerScout 3037 instruments using the BACnet protocol and 247 PowerScout 3037 instruments using the Modbus protocol.

COMMUNICATION PROTOCOL

BACnet MS/TP and Modbus RTU are standard communication protocols that allow for communication between a client and multiple devices connected to the same network. RS-485 is the protocol standard used by PowerScout meters as the hardware's physical interface while BACnet or Modbus is the networking protocol.

DAISY CHAIN LAYOUT FOR RS-485 NETWORK

When multiple devices are connected, the devices need to be connected in a daisy chain. A daisy chain means that all plus (+) connections are chained together and all minus (-) connections are chained together across the network.

A network containing multiple devices requires a unique address for each device. This allows the master device to identify and communicate with each slave. The BACnet/Modbus network administrator must assign a unique network address to each PowerScout 3037 using the rotary switches MSB and LSB.

Other network layouts, i.e., star, are not recommended when using the RS-485 standard.

NETWORKING USING THE BACNET MS/TP/MODBUS RTU PROTOCOL

- 1) Install the RS-485 cable on the RS-485 communications terminal block.
- 2) Set a unique address for each device using the table in *Establishing Communication Protocol* in the *Prepping for Field Installation* section.

Appendix C—VERIS H8035/H8036 Emulation

The PowerScout meter can be used as a direct replacement for the Veris, Inc. H8035/H8036 series of networked power meters. This mirroring of the Veris Modbus register assignments makes replacement with a PowerScout meter simple. However, because the number of parameters that the Veris meters measure is less than half of what the PowerScout can measure, the other Modbus registers described in the table need to be used to utilize the additional capabilities of the PowerScout.

Writing a 1 to register 44526 sets the Slave ID to Veris mode and ViewPoint lists the Veris registers in the ViewPoint **Read/Write Registers** tab.

When register 44526 contains a 1 for Veris mode, the Slave ID command format is:

91hFFh(Veris type), Full-Data, Modbus, (CT value) Amp

The following is an example command with CT set for 100A:

91hFFhVeris H8036-0100-2, Full-Data, Modbus, 100 Amp

Example command explanation:

- 91h = version control
- FFh = standard for active

The 91h and FFh are 4 bytes in front of the string that are not displayed in the RTU.

CT Amperage Rating	Veris Model Number
CT ≤ 100A	Veris Type = H8036-0100-2 CT Value = 100A
100A < CT ≤ 300A	Veris Type = H8036-0300-2 CT Value = 300A
300A < CT ≤ 400A	Veris Type = H8036-0400-3 CT Value = 400A
400A < CT ≤ 800A	Veris Type = H8036-0800-3 CT Value = 800A
800A < CT ≤ 1600A	Veris Type = H8036-1600-4 CT Value = 1600A
CT >1600A	Veris Type = H8036-2400-4 CT Value = 2400A

Table C-1: CT Amp Rating to Veris Models

VERIS MODBUS INTEGER REGISTERS

Modbus Register	Offset	ViewPoint Name	Description
40001	0	kWh System LSW	System True Energy (kWh, Resettable)
40002	1	kWh System MSW	System True Energy (kWh, Resettable)
40003	2	kW System	System True Power (kW)
40004	3	kVAR System	System Reactive Power (kVAR)
40005	4	kVA System	System Apparent Power (kVA)
40006	5	Apparent PF System	System Apparent Power Factor (PF)
40007	6	Volts Line to Line Avg	Average Line to Line Voltage
40008	7	Volts Line to Neutral Avg	Average Line to Neutral Voltage
40009	8	Amps System Avg	Average current of all phases
40010	9	kW L1	Individual Phase True Powers (kW, 3 values)
40011	10	kW L2	"
40012	11	kW L3	"
40013	12	Apparent PF L1	Individual Phase Apparent Power Factors (PF, 3 values)
40014	13	Apparent PF L2	"
40015	14	Apparent PF L3	"
40016	15	Volts L1 to L2	Individual Phase to Phase Voltages (Volts, Delta, 3 values)
40017	16	Volts L2 to L3	"
40018	17	Volts L1 to L3	"
40019	18	Volts L1 to Neutral	Individual Phase to Neutral Voltages (Volts, Wye, 3 values)
40020	19	Volts L2 to Neutral	"
40021	20	Volts L3 to Neutral	"
40022	21	Amps L1	Individual Phase Currents (Amps, 3 values)

Modbus Register	Offset	ViewPoint Name	Description
40023	22	Amps L2	"
40024	23	Amps L3	"
40025	24	kW System Avg	Equals KWH_SYSTEM_L&M ÷ (TimeSinceReset_L&M seconds /3600 seconds/Hr) (resettable)
40026	25	kW Demand System Min	System Minimum Demand (kW, resettable), It displays the default value after a CAM until 1 demand window elapses. After a power cycle or CPU reset the value is not reset but it does not update again until 1 demand window elapses.
40027	26	kW Demand System Max	System Max Demand (kW, resettable). Behaves as 40026.

Table C-2: ViewPoint Register Descriptions

VERIS MULTIPLIERS

Address	Units	≤ 100A	101 – 400A	401 – 800A	801 – 1600A	1601 – 32,000A
40001	kWH LSB	7.8125exp-3	0.03125	0.0625	0.125	0.25
40002	kWH MSB	512	2048	4096	8192	16384
40003	kW	0.004	0.016	0.032	0.064	0.128
40004	kVAR	0.004	0.016	0.032	0.064	0.128
40005	kVA	0.004	0.016	0.032	0.064	0.128
40006	aPF	3.0518exp-5	3.0518exp-5	3.0518exp-5	3.0518exp-5	3.0518exp-5
40007	VOLTS L-L	0.03125	0.03125	0.03125	0.03125	0.03125
40008	VOLTS L-L	0.015625	0.015625	0.015625	0.015625	0.015625
40009	AMPS	3.9063exp-3	0.015625	0.03125	0.0625	0.125
40010	kW L1	0.001	0.004	0.008	0.016	0.032
40011	kW L2	0.001	0.004	0.008	0.016	0.032
40012	kW L3	0.001	0.004	0.008	0.016	0.032
40013	aPF L1	3.0518exp-5	3.0518exp-5	3.0518exp-5	3.0518exp-5	3.0518exp-5

Address	Units	≤ 100A	101 – 400A	401 – 800A	801 – 1600A	1601 – 32,000A
40014	aPF L2	3.0518exp-5	3.0518exp-5	3.0518exp-5	3.0518exp-5	3.0518exp-5
40015	aPF L3	3.0518exp-5	3.0518exp-5	3.0518exp-5	3.0518exp-5	3.0518exp-5
40016	VOLTS L1-L2	0.03125	0.03125	0.03125	0.03125	0.03125
40017	VOLTS L2-L3	0.03125	0.03125	0.03125	0.03125	0.03125
40018	VOLTS L3-L1	0.03125	0.03125	0.03125	0.03125	0.03125
40019	VOLTS L1-N	0.015625	0.015625	0.015625	0.015625	0.015625
40020	VOLTS L2- N	0.015625	0.015625	0.015625	0.015625	0.015625
40021	VOLTS L3- N	0.015625	0.015625	0.015625	0.015625	0.015625
40022	AMPS L1	3.9063exp-3	0.015625	0.03125	0.0625	0.125
40023	AMPS L2	3.9063exp-3	0.015625	0.03125	0.0625	0.125
40024	AMPS L3	3.9063exp-3	0.015625	0.03125	0.0625	0.125
40025	kW	0.004	0.016	0.032	0.064	0.128
40026	kW	0.004	0.016	0.032	0.064	0.128
40027	kW	0.004	0.016	0.032	0.064	0.128

Table C-3: Veris Multipliers for Integer Registers 40001-40027

Per the Veris implementation, to obtain true engineering units, the values returned from the registers in Table G-2 must be multiplied by the scaling values listed in Table G-3.

For example, if the PowerScout has 100A CTs connected to it, the system reactive power (kVAR) is calculated by:

- Read register 40004
- Multiply the value returned from register 40004 by 0.004

VERIS MODBUS FLOATING POINT REGISTERS

Modbus Register	Offset	ViewPoint Name	Description
40257	256	VERIS Float kWh System MSW	System Net True Energy (kWh, Resettable)
40258	257	VERIS Float kWh System LSW	System Net True Energy (kWh, Resettable)
40261	260	VERIS Float kW System MSW	System Total True Power MSW
40262	261	VERIS Float kW System LSW	System Total True Power LSW
40263	262	VERIS Float kVAR System MSW	System Total Reactive Power MSW
40264	263	VERIS Float kVAR System LSW	System Total Reactive Power LSW
40265	264	VERIS Float kVA System MSW	System Total Apparent Power MSW
40266	265	VERIS Float kVA System LSW	System Total Apparent Power LSW
40267	266	VERIS Float PF System MSW	System Total Power Factor MSW
40268	267	VERIS Float PF System LSW	System Total Power Factor LSW
40269	268	VERIS Float Volts Line to Line Avg MSW	Voltage Line to Line Average MSW
40270	269	VERIS Float Volts Line to Line Avg LSW	Voltage Line to Line Average LSW
40271	270	VERIS Float Volts Line to Neutral Avg MSW	Voltage Line to Neutral Average MSW
40272	271	VERIS Float Volts Line to Neutral Avg LSW	Voltage Line to Neutral Average LSW
40273	272	VERIS Float Amps System Avg MSW	Total Current in all Phases MSW
40274	273	VERIS Float Amps System Avg LSW	Total Current in all Phases LSW
40275	274	VERIS Float kW L1 MSW	Individual Phase True Power L1 MSW
40276	275	VERIS Float kW L1 LSW	Individual Phase True Power L1 LSW
40277	276	VERIS Float kW L2 MSW	Individual Phase True Power L2 MSW
40278	277	VERIS Float kW L2 LSW	Individual Phase True Power L2 LSW
40279	278	VERIS Float kW L3 MSW	Individual Phase True Power L3 MSW

Modbus Register	Offset	ViewPoint Name	Description
40280	279	VERIS Float kW L3 LSW	Individual Phase True Power L3 LSW
40281	280	VERIS Float Apparent PF L1 MSW	Individual Phase Apparent Power Factor L1 MSW
40282	281	VERIS Float Apparent PF L1 LSW	Individual Phase Apparent Power Factor L1 LSW
40283	282	VERIS Float Apparent PF L2 MSW	Individual Phase Apparent Power Factor L2 MSW
40284	283	VERIS Float Apparent PF L2 LSW	Individual Phase Apparent Power Factor L2 LSW
40285	284	VERIS Float Apparent PF L3 MSW	Individual Phase Apparent Power Factor L3 MSW
40286	285	VERIS Float Apparent PF L3 LSW	Individual Phase Apparent Power Factor L3 LSW
40287	286	VERIS Float Volts L1 to L2 MSW	Phase to Phase Voltage L1 to L2 MSW
40288	287	VERIS Float Volts L1 to L2 LSW	Phase to Phase Voltage L1 to L2 LSW
40289	288	VERIS Float Volts L2 to L3 MSW	Phase to Phase Voltage L2 to L3 MSW
40290	289	VERIS Float Volts L2 to L3 LSW	Phase to Phase Voltage L2 to L3 LSW
40291	290	VERIS Float Volts L1 to L3 MSW	Phase to Phase Voltage L1 to L3 MSW
40292	291	VERIS Float Volts L1 to L3 LSW	Phase to Phase Voltage L1 to L3 LSW
40293	292	VERIS Float Volts L1 to Neutral MSW	Phase to Neutral Voltage L1 to N MSW
40294	293	VERIS Float Volts L1 to Neutral LSW	Phase to Neutral Voltage L1 to N LSW
40295	294	VERIS Float Volts L2 to Neutral MSW	Phase to Neutral Voltage L2 to N MSW
40296	295	VERIS Float Volts L2 to Neutral LSW	Phase to Neutral Voltage L2 to N LSW
40297	296	VERIS Float Volts L3 to Neutral MSW	Phase to Neutral Voltage L3 to N MSW
40298	297	VERIS Float Volts L3 to Neutral LSW	Phase to Neutral Voltage L3 to N LSW
40299	298	VERIS Float Amps L1 MSW	Phase Current L1 MSW
40300	299	VERIS Float Amps L1 LSW	Phase Current L1 LSW
40301	300	VERIS Float Amps L2 MSW	Phase Current L2 MSW
40302	301	VERIS Float Amps L2 LSW	Phase Current L2 LSW

Modbus Register	Offset	ViewPoint Name	Description
40303	302	VERIS Float Amps L3 MSW	Phase Current L3 MSW
40304	303	VERIS Float Amps L3 LSW	Phase Current L3 LSW
40305	304	VERIS Float kW System Avg MSW	System Average Power MSW
40306	305	VERIS Float kW System Avg LSW	System Average Power LSW
40307	306	VERIS Float Demand System Minimum MSW	System Minimum Demand MSW
40308	307	VERIS Float Demand System Minimum LSW	System Minimum Demand LSW
40309	308	VERIS Float Demand System Maximum MSW	System Maximum Demand MSW
40310	309	VERIS Float Demand System Maximum LSW	System Maximum Demand LSW

Table C-4: VERIS Modbus Floating Point Registers

Appendix D—Conversion Table

DECIMAL TO HEXADECIMAL CONVERSION TABLE

Some equipment use decimal Modbus addressing; the table below is useful for converting decimal addressing to hexadecimal addressing.

Decimal	Hex	Decimal	Hex	Decimal	Hex	Decimal	Hex	Decimal	Hex	Decimal	Hex
1	01	44	2C	87	57	130	82	173	AD	216	D8
2	02	45	2D	88	58	131	83	174	AE	217	D9
3	03	46	2E	89	59	132	84	175	AF	218	DA
4	04	47	2F	90	5A	133	85	176	B0	219	DB
5	05	48	30	91	5B	134	86	177	B1	220	DC
6	06	49	31	92	5C	135	87	178	B2	221	DD
7	07	50	32	93	5D	136	88	179	B3	222	DE
8	08	51	33	94	5E	137	89	180	B4	223	DF
9	09	52	34	95	5F	138	8A	181	B5	224	E0
10	0A	53	35	96	60	139	8B	182	B6	225	E1
11	0B	54	36	97	61	140	8C	183	B7	226	E2
12	0C	55	37	98	62	141	8D	184	B8	227	E3
13	0D	56	38	99	63	142	8E	185	B9	228	E4
14	0E	57	39	100	64	143	8F	186	BA	229	E5
15	0F	58	3A	101	65	144	90	187	BB	230	E6
16	10	59	3B	102	66	145	91	188	BC	231	E7
17	11	60	3C	103	67	146	92	189	BD	232	E8
18	12	61	3D	104	68	147	93	190	BE	233	E9
19	13	62	3E	105	69	148	94	191	BF	234	EA
20	14	63	3F	106	6A	149	95	192	C0	235	EB
21	15	64	40	107	6B	150	96	193	C1	236	EC
22	16	65	41	108	6C	151	97	194	C2	237	ED
23	17	66	42	109	6D	152	98	195	C3	238	EE
24	18	67	43	110	6E	153	99	196	C4	239	EF
25	19	68	44	111	6F	154	9A	197	C5	240	F0
26	1A	69	45	112	70	155	9B	198	C6	241	F1
27	1B	70	46	113	71	156	9C	199	C7	242	F2
28	1C	71	47	114	72	157	9D	200	C8	243	F3
29	1D	72	48	115	73	158	9E	201	C9	244	F4

Decimal	Hex	Decimal	Hex	Decimal	Hex	Decimal	Hex	Decimal	Hex	Decimal	Hex
30	1E	73	49	116	74	159	9F	202	CA	245	F5
31	1F	74	4A	117	75	160	A0	203	CB	246	F6
32	20	75	4B	118	76	161	A1	204	CC	247	F7
33	21	76	4C	119	77	162	A2	205	CD	248	F8
34	22	77	4D	120	78	163	A3	206	CE	249	F9
35	23	78	4E	121	79	164	A4	207	CF	250	FA
36	24	79	4F	122	7A	165	A5	208	D0	251	FB
37	25	80	50	123	7B	166	A6	209	D1	252	FC
38	26	81	51	124	7C	167	A7	210	D2	253	FD
39	27	82	52	125	7D	168	A8	211	D3	254	FE
40	28	83	53	126	7E	169	A9	212	D4	255	---
41	29	84	54	127	7F	170	AA	213	D5		
42	2A	85	55	128	80	171	AB	214	D6		
43	2B	86	56	129	81	172	AC	215	D7		

Table D-1: Decimal to Hexadecimal Conversion Table

Appendix E—The PS3037 Optional Visual Display



An optional digital display is available for the PS3037. It has 2 rows of 16 characters that auto cycle between informational screens every 2 seconds, with real-time values updated every second. A “hold” button will stop the cycle until it is pressed again or a set timeout is reached. The following flowchart shows what information is displayed during the cycles.

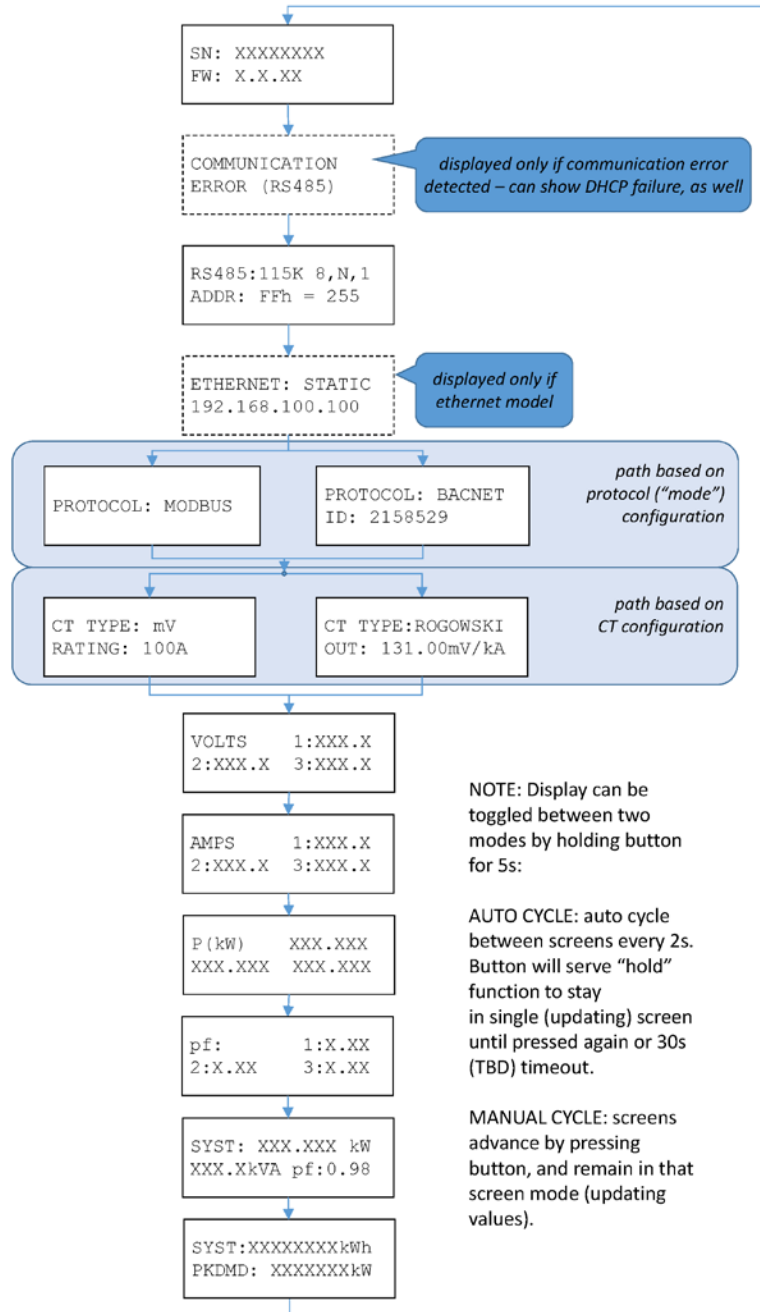

Appendix F—Troubleshooting

TROUBLESHOOTING COMMUNICATION ISSUES

When the baud rate on the ViewPoint **Communications** screen and the PowerScout do not match, communication fails and a Communication Error message displays in the Status field:

“Unable to establish connection with meter, please check settings and try again.”

The following headings provide possible solutions for communication errors. You can connect via USB or to get the RS485 back to a known state.

Baud Rate Communications Error (RS-485 only)

To correct a baud rate communications error, use the following steps:

- 1) In ViewPoint, set the *Modbus Base Address Switches* field to **00**.
- 2) On the PowerScout, set the address switches to **00**.
- 3) Power up the meter. With both settings at 00, ViewPoint and the PowerScout will communicate at a 9600 baud rate regardless of a baud rate mismatch. Communications is established.
- 4) Next, select the desired baud rate in ViewPoint from the Baud Rate drop-down list. This synchronizes the baud rates between ViewPoint and the PowerScout.
- 5) Click **Connect** in ViewPoint to reconfirm communications.

Port Error

If the **PC COM Port** drop-down list does not contain a RS-485 port, the RS-485 adapter driver is not installed or the device is not connected to the computer’s USB port. Check that the adapter is connected to a live USB port or move the USB cable to another USB port.

Firmware Update Fails

When the firmware update fails, select a slower baud rate and retry the update.

Other Communication Failures (RS-485 only)

The following items can also cause a communication failure.

- Check for wiring and cabling issues with the RS-485 adapter. Check for polarity, frayed wires, and/or pinched insulation.
- Verify that the dip switches on the back of the USB to RS-485 adapter are set to the following:

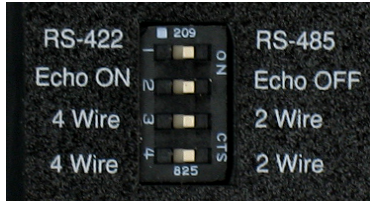

- Reboot the computer. Click **Connect** on the Communications tab to reestablish communications.

FREQUENTLY ASKED QUESTIONS

What is the maximum distance for BACnet MS/TP or Modbus (RS-485) communication?

BACnet MS/TP or Modbus (RS-485) can reach a distance up to 1200 meters (4000') with data rates at 100 kbps.

One (or more) of the PhaseChek™ LEDs is red. What does this mean?

Any number of red lights indicates the PowerScout meter is wired incorrectly. Review the table in *PhaseChek* in Section III of this manual for a description of the indicator lights.

How is the PowerScout meter powered?

All PowerScout™ instruments are line-powered. An internal power supply attached between L1 and L2 provides power to the unit.

Can the PowerScout be used to monitor single-phase loads?

The PowerScout meter can be used to monitor single-phase loads. Refer to Section II or III for detailed setup information.

How many PowerScout instruments can be connected together?

Up to 127 PowerScout 3037 meters can be connected together on a BACnet MS/TP network.

Up to 247 PowerScout 3037 meters can be connected together on a Modbus RTU network.

How is hexadecimal (HEX) to decimal converted?

Use the Decimal to Hexadecimal conversion table in Appendix D of this manual.

What is true RMS?

RMS stands for "Root-Mean-Square." True RMS is the power from AC voltage/current that will produce the equivalent amount of heat in a resistor as a DC voltage/current, whether sinusoidal or not. For example, if a resistive heating element is rated at 15 kW of heat at 240VAC RMS, then the heat would be the same if we applied 240V of DC instead of AC. A meter without true RMS will incorrectly read distorted waveforms. All DENT Instruments meters measure true RMS.

How accurate are the PowerScout meters?

The PowerScout 3037 meter accuracy is <0.02%. Meets ANSI C12.20-2010

What is the lead length for RōCoil CTs?

The maximum lead length for the RōCoils is 30 meters (100').

Can a three-phase balanced load be monitored with one CT?

This is not the best way to measure a three-phase load as it ignores imbalances in voltage and power factor. However, if desired there is an Amp Multiplier Modbus register (44605) that can be set for three (3), which will multiply the current by three and therefore amps, watts, VA, VARs will be 3X greater.

How can I switch the PowerScout from BACnet to Modbus mode?

Using a PC running ViewPoint™ (or an RTU that can write to BACnet objects), write to object **10190** the value **375** (to change to Modbus).

How can I switch the PowerScout from Modbus to BACnet mode?

Using a PC running ViewPoint™ (or an RTU that can write to Modbus registers), write to register **44612** the value **1833** (to change to BACnet).

How can I fix BACnet network timing errors/slowness?

The maximum number of the MSTP master should be set to the highest MAC address present in the network. Max Master is a setting on the Communications tab of the ViewPoint™ software.

What is the purpose of setting a scalar value?

Each Modbus register is only 16 bits wide and is in integer format without any fixed number of decimal points. Simply putting a value directly into one of these registers would limit the smallest number to 1, and only allow for a maximum value of 65535. To handle larger numbers, or numbers with better resolution, we use a scalar value to apply a factor in multiples of 10 to the 16 bit data register value.

How do I update the firmware in BACnet mode?

If not using a USB connection, the PowerScout meter must be in Modbus mode in order to use ViewPoint to update the firmware (either through the software switch or the rotary switches).

GLOSSARY

Amp Multiplier	A multiplier that changes amperage so that a meter can read higher measurements.
Analog Value	A type of BACnet object that is a floating point number. On the PowerScout, Analog Value objects are used to represent the electrical measurements.
BACnet	B uilding A utomation C ontrol n etworks. A communications protocol that allows building automation and control devices and their associated properties (objects) to be automatically discovered.
CAM	C lear A ll M easurements
Data Scalar	A scalar is used to multiply the raw data value to convert information read from the Modbus registers. Refer to Table II-6 for a list of values. Example: if the scalar value in register 44602 is set to 3 and the total true power for the system (kW) is read from Modbus register 44003 (Offset 4002) and a value of 3465 is returned, the true system kW is: $3465 \times 0.1 = 346.5 \text{ kW}$
Demand Window	The Demand Window is how long the meter calculates your demand for recording a value. For example if your Demand Window is set to 15 min, the meter will calculate your total demand every minute for 15 minutes. At the end of the 15 minutes it will sum all 15 values. Then it will record that value as the demand.
Digital Output	The PowerScout meter has an output port for each element. The ports can be used to output kWh, kVARh, or kVAh pulses to external devices, or to toggle on and off to control a remote device or relay.
Discovery	In BACnet devices and the objects they expose can be found through a discovery process. This means that devices and objects do not need to be manually added if a BACnet client supports discovery.
Falling edge	Transition of the input signal from high to low.
Hexadecimal	In mathematics and computer science, hexadecimal (or hex) is a numeral system with a radix, or base, of 16. It uses sixteen distinct symbols, most often the symbols 0–9 to represent values zero to nine, and A, B, C, D, E, F (or a through f) to represent values ten to fifteen.
kVAh	Kilovolt-Ampere Hour
kVARh	Kilovolt Ampere Reactive Hours
kWh	Kilowatt Hour
LSB	Least significant bit
LSW	(Modbus mode only) Least Significant Word. Unit of data with the low-order bytes at the right.
MS/TP	Master-Slave/Token Passing is a model of communication used by BACnet where one device (the master node) has unidirectional control of the RS-485 serial bus. The token is passed from master node to master node to allow a master node to send frames over the bus.
MSB	Most significant bit

MSW	(Modbus mode only) Most Significant Word. Unit of data with the high-order bytes at the left.
Net	When a register/object has the word “net” in its description than net equals the sum of all individual signed measurements.
Object	A BACnet object is a standard data structure that on the PowerScout represents electrical measurements.
Power Factor	The power factor of the AC electric power system is defined as the ratio of the real power flowing to the load to the apparent power, and is a number between 0 and 1 (frequently expressed as a percentage, e.g., 0.5 pf = 50% pf). Real power is the capacity of the circuit for performing work in a particular time. Apparent power is the product of the root mean squared current and root mean squared voltage of the circuit. Due to energy stored in the load and returned to the source, or due to a non-linear load that distorts the wave shape of the current drawn from the source, the apparent power can be greater than the real power.
Pulse Input	Used for counting, accumulating, and scaling pulses received from non-DENT external pulse initiating meters such as gas, water, or other electrical meters.
Pulse Output	Pulse output is used to generate pulses for external devices such as data loggers that can accept pulses but do not have Modbus capability. The PowerScout can generate pulses based on accumulated value(s) such as system kWh, system kVARh, and system kVAh.
Rising edge	Transition of the input signal from low to high.
RMS	Root-Mean-Square. True RMS is the AC voltage/current that produces the equivalent amount of heat in a resistor as a DC voltage/current, whether sinusoidal or not. All DENT Instruments meters measure true RMS.
RS-485	EIA-485 is used as the physical layer underlying many standard and proprietary automation protocols used to implement Industrial Control Systems, including BACnet/Modbus.
RTU	A Remote Terminal Unit (RTU) is a microprocessor controlled electronic device which interfaces objects in the physical world to a distributed control system or SCADA system by transmitting telemetry data to the system and/or altering the state of connected objects based on control messages received from the system.
SCADA	SCADA stands for Supervisory Control And Data Acquisition. It generally refers to an industrial control system: a computer system monitoring and controlling a process.
Service	A BACnet service are messages to which the PowerScout must respond and end. In BACnet these include Whols, I-Am, and ReadProperty.
Volts Multiplier	A multiplier that changes voltage so that a meter can read measurements higher than 600V.