

REED

Model R3030/R3100 Digital Manometer

Instruction Manual



www.reedinstruments.com

REED Instruments

1-877-849-2127 | info@reedinstruments.com | www.reedinstruments.com

Table of Contents

Features.....	3
Specifications.....	3-4
Instrument Controls & Indicators.....	4-5
Operating Instructions.....	5-9
<i>Auto Power-Off</i>	5
<i>Mode Options</i>	5-7
<i>Calibration Mode</i>	7-8
<i>Calibration Point Reference</i>	8
<i>Manual Zero Setting</i>	9
Troubleshooting.....	9-10
Battery Replacement.....	10
Maintenance.....	11

Features

- Portable, battery-operated pressure measuring device
- Measures gauge pressure (a measure of pressure in psi that is reference to ambient pressure) and differential pressure (a measure of the difference between two pressures)
- 11 selectable pressure units: bar, mmHg, ozin², kgcm², psi, inH₂O, kPa, ftH₂O, inHg, cmH₂O, mbar
- Primary LCD readout displays current pressure reading while secondary readout displays real time clock
- Not suitable for absolute pressure measurement

Specifications

Range: R3030:	0~30 psi; 830 inH ₂ O; 2068 mbar; 2.10 kg/cm ²
R3100:	0~100 psi; 2768 inH ₂ O; 6895 mbar; 7.03 kg/cm ²
Accuracy:	0.3% of full scale at 25°C
Resolution:	

Unit	Range	Model R3030	Model R3100
psi	1.000000	0.02	0.1
inH ₂ O	27.680517	0.5	2
bar	0.068948	0.002	0.004
mbar	68.948253	2	4
mmHg	51.712016	1	3
ozin ²	16.000844	0.3	1
kg/cm ²	0.070309	0.002	0.004
kPa	6.894859	0.2	0.4
ftH ₂ O	2.306719	0.04	0.2
cmH ₂ O	70.309000	2	4

continued ...

REED Instruments

1-877-849-2127 | info@reedinstruments.com | www.reedinstruments.com

Response Time:	0.5 seconds
Format:	Baud Rate: 2400 bit/sec; Data Bit: 8, Stop Bit: 1
Compensated Temp. Range:	0~50°C
Operating Temperature:	0~50°C
Operating Humidity:	≤80% RH
Storage Temperature:	-20~55°C
Power Supply:	Single 9V battery
Dimensions:	72 x 182 x 30 mm
Weight:	Approx. 220 g (with battery)
Includes:	2 x connection hose (4mm x 6mm (ID x OD)), battery, hard carrying case, and user manual

Instrument Controls & Indicators

1. LCD screen displays pressure value
2. “-” Negative pressure display
3. **MAX/MIN** pressure
4. **REC** internal recording mode displays max./min. pressure*
5. **DC** power input jack
6. **Y/M/D H/M/S** Real-time clock 88:88:88 displays data Year/Month/Day, Hour/Minute/Second
7. ▼ Pressure unit indication
8. **BAT** Low battery indicator
9. **DIF** Differential pressure mode

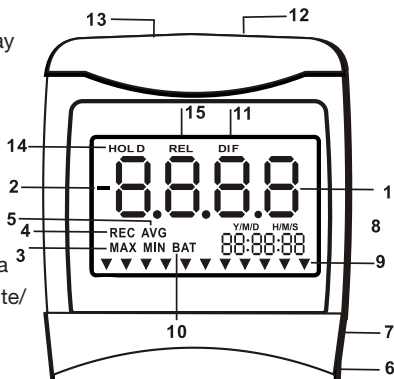

continued ...

REED Instruments

1-877-849-2127 | info@reedinstruments.com | www.reedinstruments.com

10. “-” Negative pressure hose connection
11. “+” Positive pressure hose connection
12. **HOLD** Freezes pressure reading
13. **REL** Establishes a relative zero for the primary screen information

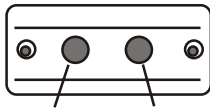

“-” Negative pressure

“+” Positive pressure

*Record mode does not act as a data logger but will capture single max/min data points

Operating Instructions

Note: This meter is fitted with two 4.8mm lugs. Before you connect the meter to a pressure source, carefully check the security of all fittings.

Auto Power-Off (Sleep function)

1. This instrument shuts off automatically after approx. 20 minutes of inactivity.
2. For operating over longer periods of time, you can disable the sleep mode by pressing **⓪** and **HOLD** simultaneously before powering on.
3. An “n” will appear in the middle of the screen at which time you can release the **HOLD** button. (See Fig. A)
4. The disabled sleep mode will be invalid after power off.

Fig. A



Mode Options

There are six function keys for mode selection as well as measurement operation. For your convenience, the meter defaults to the setting used in the last operation.

The following lists the operation for each function key.

- ⓪** Turns instrument on (Default setting) and off.

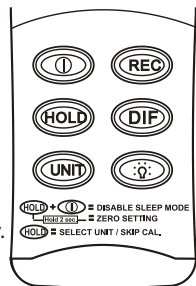

continued ...

REED Instruments

1-877-849-2127 | info@reedinstruments.com | www.reedinstruments.com

REC Press to enter recording. A counter will begin and REC will show up on screen indicating you have begun recording. Press the **REC** button again and the unit will cycle through the **MAX** (Fig. C) and **MIN** (Fig. D) measurements captured during the recording mode. Press and hold **REC** for 3 seconds to turn off the record function and to return to normal mode.

HOLD Press momentarily to freeze the current pressure reading. (See Fig. E)

DIF Press momentarily, **DIF** appears on top of the LCD and the display indicates the relative zero (Relative zero causes the value of the display to show as “0.0”); only the amount of pressure change will be indicated. Press momentarily again and the unit returns to the normal mode of pressure differential (See Fig. F).

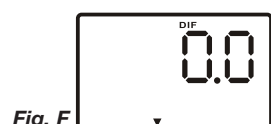
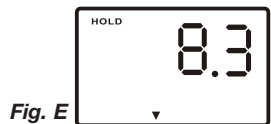
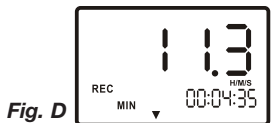
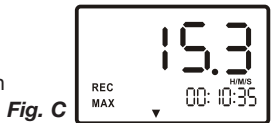
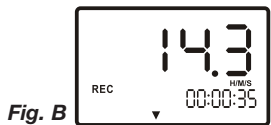

Note: Differential Pressure is a measure of the difference between two pressures, i.e. use differential pressure sensor to measure gauge pressure by leaving one process connection open to atmosphere and connecting the second sensor port to your system.

continued ...

UNIT Press momentarily and the unit will cycle through "bar", "mmHg", "ozin²", "kgcm²", "psi", "inH₂O", "kPa", "ftH₂O", "inHg", "cmH₂O", "mbar" which is indicated on the bottom of the display (Fig. G & H).

☼ Press momentarily and the backlight illuminates for approx. 30 seconds then turns off automatically. Or press momentarily to decrease the time when calibration is being performed.

Calibration Mode

1. Manually set the display to zero (no pressure applied to the connector), refer to Manual Zero procedure.
2. Turn the meter off.
3. Press **REC** & **☼** simultaneously, "CA" appears on the display (See Fig. I). When the meter is in calibration mode, make sure the arrow mark "▼" is positioned under the "psi" pressure unit to start positive (+) pressure calibration.
4. The meter defaults to a 80 psi calibration point, the adjustable pressure range is from 78.0 to 82.0 psi. If the calibration pressure source is not at 80 psi, increase the figure by pressing **DIF** button or decrease the figure by pressing **☼** button, to set calibration point as required.
5. Save the calibration point by pressing **REC** button, "SA" and small "CA" appears on the display (See Fig. J).

Fig. G

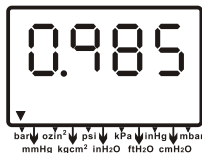

Fig. H

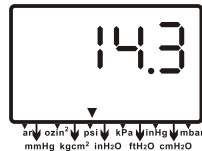
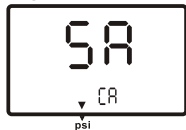

Fig. I



Fig. J



continued ...

The meter auto-skips to the negative pressure (-) point for the next calibration mode.

- Follow the same procedure as outlined in Step 4 for the negative pressure calibration point by pressing **(UNIT)** button, the LCD now displays **"-80.0"** and small **"CA"** (See Fig. K). To set the necessary calibration figure refer to your pressure standard if needed.
- Again save the calibration point by pressing **(REC)** button, **"SA"** and **"CA"** appears in 2 seconds and then **"End"** and **"CA"** appears in another 2 seconds, the meter returns to normal mode (See Fig. L).

Fig. K



Fig. L



Note: If you cannot save by pressing **(REC)** button, i.e. no **"SA"** appeared, please check: (a) that the calibration pressure source is between 75.0 and 85.0, or check (b) if you entered the right positive pressure (+) or negative (-) pressure.

If you want to skip positive (+) calibration procedure when entered into Calibration mode, press **(UNIT)** button to skip to negative (-) calibration point. Above calibration is an example for Model R3100, i.e. the pressure range is from 0 to +100psi (positive pressure) or from 0 to -100 psi (negative pressure).

Calibration Point Reference

Model	PSI Range	Calibration Point	Recommended
R3030	0~±30	±24.00	±23.40~24.60
R3100	0~±100	±80.00	±78.00~82.00

Manual Zero Setting

When you set the display to zero (no pressure applied to the connector), press **HOLD** button for 2 seconds, the meter displays “0.0.0.0” from right to left (See Fig.M) and then delete each “0” from left back to right, the LCD display shows a normal mode (See Fig.N).

Troubleshooting

- **Power on but no display.** Check that the battery is properly installed ensuring that contact with terminals and polarity are correct, replace with a new battery or attach optional AC adapter.
- **BAT indication.** Replace with a new battery when LCD displays **BAT** at the middle bottom of screen.
- **No display.** Make sure that the battery is not drained, if the display disappears, verify if sleep mode is active. Refer to the Disable sleep mode function for long term measurement. Check that the tubing is tightly connected to the meter.
- **Err.1.** If the pressure value exceeds the range maximum, “**Err.1**” appears on the display (See Fig. O), it is recommended to use a meter with a higher range, otherwise, the meter will be damaged in use.
- **Err.2.** If the pressure value is less than the range minimum, “**Err.2**” appears on the display (See Fig. P), it is recommended to use a meter with a lower range to ensure measurement accuracy.
- **Err.3.** While operating the DIF function, if the differential pressure value is larger than maximum display digit, **Err.3** appears on the display (See Fig.Q).

Fig. M

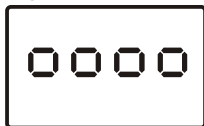

Fig. N

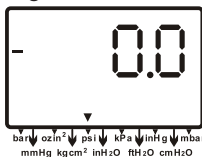

Fig. O



Fig. P



Fig. Q



continued ...

- **Err.4.** When you set zero, ensure you have disconnected the tubing and that no pressure is applied to the connector. If **Err.4** appears on the display, it means the sensor or the meter are damaged (See Fig.R). Return the unit to point of purchase for repair.

Err.4 will also appear when the tube or the hose is connected during setting zero mode.

Fig. R



Battery Replacement

Replace the battery when

- The **BAT** icon appears on the left side of the display screen
- The meter will not power on
- Use of the backlight causes the BAT icon to appear

Even if the battery was recently replaced, check its voltage level if you get no response from your instrument.

To replace the battery:

1. Remove the tubing of the instrument.
2. Lay the instrument face-down on a clean, flat surface.
3. Remove the battery with a screwdriver and observe indicated polarity and close the cover after replacing with a new battery.

Note: Remove battery from instrument if you do not plan to use for a month or more.

Do not leave battery in instrument.

Maintenance

- The meter is factory calibrated before shipping.
- To maintain the meter in the good condition for use, we recommend you calibrate the meter after long term continuous use.
- When properly maintained, the meter will maintain an accuracy specification, to ensure your meter is performing at its peak, send it to the factory or a qualified instrument calibration facility for annual calibration.
- We recommend that you always set the instrument to zero before measurement. Refer to the zero setting procedure on page 9.

Cleaning

Use a damp cloth and mild soap to clean the case of the Manometer. Do not use harsh detergents or abrasives as these may mar the finish or damage the unit's case with an adverse chemical reaction.

Notes
