



Digi TransPort® Routers

Models WR11, WR21, WR31, WR41, WR44, WR44 R,
WR44 RR

User Guide

Revision history—90001019

Revision	Date	Description
R	May 2018	Updated content for the Digi TransPort version 6.1.x. <ul style="list-style-type: none">■ Added support for IPv6.■ Updated content for configuring supported cellular modules.■ Added instructions for enabling health reporting via Digi Remote Manager.■ Added descriptions for backup and restore settings.■ Miscellaneous editorial corrections.
S	July 2018	Updated content for the Digi TransPort version 6.1.x. <ul style="list-style-type: none">■ Added support for Cellular GPS to the WR31.
T	March 2019	Updated content for the Digi TransPort version 7.0.x. <ul style="list-style-type: none">■ Added support for automatic APN selection.■ Added Network start verbose call end reasons to troubleshooting information.■ Added IFETEL certification information for certain models of WR11, WR21, and WR31 devices.
U	July 2019	<ul style="list-style-type: none">■ Corrected power statements for the WR44 R.■ Added "Powering the WR44 R" Section.
V	December 2019	Updated content for the Digi TransPort version 8.0.x. <ul style="list-style-type: none">■ Changed default password behavior to comply with California law.

Trademarks and copyright

Digi, Digi International, and the Digi logo are trademarks or registered trademarks in the United States and other countries worldwide. All other trademarks mentioned in this document are the property of their respective owners.

© 2019 Digi International Inc. All rights reserved.

Disclaimers

Information in this document is subject to change without notice and does not represent a commitment on the part of Digi International. Digi provides this document “as is,” without warranty of any kind, expressed or implied, including, but not limited to, the implied warranties of fitness or merchantability for a particular purpose. Digi may make improvements and/or changes in this manual or in the product(s) and/or the program(s) described in this manual at any time.

Warranty

To view product warranty information, go to the following website:

www.digi.com/howtobuy/terms

Customer support

Gather support information: Before contacting Digi technical support for help, gather the following information:

- ✓ Product name and model
- ✓ Product serial number (s)
- ✓ Firmware version
- ✓ Operating system/browser (if applicable)
- ✓ Logs (from time of reported issue)
- ✓ Trace (if possible)
- ✓ Description of issue
- ✓ Steps to reproduce

Contact Digi technical support: Digi offers multiple technical support plans and service packages. Contact us at +1 952.912.3444 or visit us at www.digi.com/support.

Feedback

To provide feedback on this document, email your comments to

techcomm@digi.com

Include the document title and part number (Digi TransPort® Routers User Guide, 90001019 V) in the subject line of your email.

Contents

Digi TransPort® routers

TransPort WR11	15
TransPort WR21	17
TransPort WR31	18
TransPort WR41	20
TransPort WR44 / WR44 R	21
TransPort WR44 RR	22

Hardware features

TransPort WR11 hardware features	24
TransPort WR11 EVDO model	24
TransPort WR11 HSPA+ model	25
TransPort WR11 LTE-MIMO	26
TransPort WR11 XT	27
TransPort WR11 accessories	29
TransPort WR11 hardware specifications	30
Regulatory and safety statements	31
TransPort WR21 hardware features	36
TransPort WR21 front panel	36
TransPort WR21 rear panel features	37
Reset the TransPort WR21	38
TransPort WR21 serial pinout	39
TransPort WR21 accessories	41
TransPort WR21 hardware specifications	42
Regulatory and safety statements	42
TransPort WR31 hardware features	47
TransPort WR31 hardware specifications	50
TransPort WR31 accessories	51
TransPort WR31 mounting options	52
Hazardous Location installation	53
TransPort WR31 serial pinout	54
TransPort WR31 digital and analog inputs and outputs	56
I/O connector pin assignments	56
TransPort WR31 digital input/output: representative circuit	57
TransPort WR31 analog input: representative circuit	57
Example digital and analog I/O wiring	58
Digital output	58
Digital and analog I/O specifications	60
Regulatory and safety statements	62

TransPort WR41 hardware features	67
Front panel	67
Rear panel	68
Underside of unit features	69
Additional hardware features	70
TransPort WR41 hardware specifications	72
TransPort WR41 accessories	73
TransPort WR41 serial pinout	74
Regulatory and safety statements	75
TransPort WR44 / WR44 R hardware features	79
Front panel	79
TransPort WR44 models with cellular interface	79
TransPort WR44 models without SIM card slots	79
Rear panel	80
Underside of unit	81
Enclosure features	82
TransPort WR44 additional hardware features	83
Powering the TransPort WR44 R	84
TransPort WR44 hardware specifications	85
TransPort WR44 R hardware specifications	86
TransPort WR44 accessories	87
TransPort WR44 R accessories	88
TransPort WR44 / WR44 R RS232 serial pinout	89
Regulatory and safety statements	90
TransPort WR44 RR hardware features	94
Front panel	94
Rear panel	94
Enclosure features	95
TransPort WR44 RR hardware specifications	96
TransPort WR44 RR accessories	97
TransPort WR44 RR Ethernet cable connectors and pinouts	98
Regulatory and safety statements	100
Purchase additional serial cables	104
Signal strength indicators	105
Antenna specifications for Wi-Fi 2.4 GHz modules	106

Using the web interface

Log in to the device	108
Log out and return to the login page	110
Execute a command from the web interface	111
Signal strength indicators on the Mobile status page	112
Use the web interface wizards	113
Use the Quick Start wizard	114
Use the Serial Interface wizard	115
Use the Create an aggressive mode LAN to LAN IPsec tunnel wizard	116
Use the SureLink wizard	117
Use the GOBI Module Carrier wizard	119
Use the Dual SIM wizard	120

Using the command-line interface

About the Digi TransPort command line interface	122
Supported command types	123

Required software for using the command line	124
Connect to the TransPort router from a PC	125
Log in to the command line interface	126
Exit the command line interface	127
Commands and the active port	128
When commands take effect	129
View current configuration changes	130
Save changes	131
Configure network settings	132
Establish a remote connection	134
Application commands	135
Application commands are case-insensitive	135
One command per line	135
Application command syntax	135
Use wildcards in commands	135
Use special usernames in commands	136
Using the command-line parameter tables in this guide	137
Activate and deactivate interfaces	139
ana command: Clear the Analyser Trace	140
config command: show/save configuration	141
config changes command: show number of changes counter	142
clear command: Clear the event log	143
gpio command: General Purpose Input Output (GPIO)	144
ping command: Troubleshoot connectivity problems	146
qdl command: Select cellular image to load	147
reboot command: reboot router	148
tcpperm command: establish a permanent serial to IP connection	149
tcpdial command: Establish a manually initiated serial to IP connection	151
tcpdab command: Cancel a tcpdial connection	152
templog command: monitor router temperature	153
traceroute command: Troubleshoot connectivity problems	154
AT commands	155
The AT command interface	155
Enter multiple commands	155
Use escape sequences	155
AT command result codes	156
S registers	157
atd: Dial a call	158
ath: Hang-up	159
atz: Reset	160
at&c: Control the DCD signal	161
at&f: Load factory settings	162
at&r: Control the CTS signal	163
at&v: View profiles	164
at&w: Write SREGS.DAT file	165
at&y: Select power-up profile	166
at&z: Store phone number	167
at\at: Ignore invalid AT commands	168
at\gps command: Send GPS data to ASY port	168
at\ls: Lock speed	169
at\port: Set the active port for text commands	170
at\smib commands	171
S register definitions	177

Configuring network interfaces

Configure Ethernet interfaces	182
IPv6 addressing support on Ethernet interfaces	182
Configure basic Ethernet IP address parameters	183
Configure advanced Ethernet parameters	185
Configure Ethernet Quality of Service (QoS) parameters	195
Configure Ethernet Virtual Router Redundancy Protocol (VRRP)	198
Configure logical Ethernet interfaces	202
Configure which Ethernet devices can send packets to the router (MAC filtering)	203
Configure an Ethernet bridge between two networks (MAC bridging)	205
Configure Rapid Spanning Tree Protocol (RSTP)	207
Configure Virtual LAN (VLAN) support	209
Configure Wi-Fi interfaces	211
Configure global Wi-Fi settings	212
Configure advanced global Wi-Fi settings	216
Configure a Wi-Fi node as a hotspot	217
Configure Wi-Fi filtering	218
Configure a Wi-Fi node	219
Perform a rogue scan	225
Configure mobile (cellular) interfaces	226
Configuration parameters required from your mobile network	226
Supported cellular modules in Digi TransPort products	227
Configure SIMs	228
Configure mobile connection settings	229
Configure SIM failover	234
Configure advanced mobile parameters	235
Configure sending and receiving SMS messages	245
Verify mobile connectivity and check mobile status	249
Automatic SIM detection	251
Determine the cellular module type and carrier firmware version	252
Switch the cellular carrier firmware	253
Update carrier firmware	257
Configure DSL interfaces	260
Configure permanent virtual circuit (PVC) parameters	261
Configure DSL network settings	262
Configure PVC traffic shaping parameters	266
Configure advanced DSL parameters	268
Configure Generic Routing Encapsulation (GRE) interfaces	270
Configure GRE tunnel parameters	271
Configure advanced GRE parameters	274
Configure ISDN interfaces	276
Configure the ISDN interface to receive incoming calls	277
Configure ISDN dialing parameters	282
Configure advanced ISDN parameters	287
Configure ISDN Link Access Protocol D (LAPD) parameters	291
Configure ISDN to answer V.120 calls	294
Configure PSTN interfaces	296
Configure advanced PSTN parameters	301
Configure DialServ interfaces	305
Configure DialServ network settings	306
Configure advanced DialServ parameters	310
Configure serial interfaces	314
Configure advanced serial port parameters	317
Configure synchronous communications	321

Configure rate adaptation	323
Configure command alias mappings	325
Configure protocol bindings	327
Configure virtual serial ports	329
Configure port redirection using RealPort	331
Configure sending serial data to multiple serial ports	335
Configure IPv6 addressing support	338
IPv6 support is for Ethernet interfaces only	338
IPv6 modes	338
Typical IPv6 configuration	338
IPv6 support in the web interface	340
IPv6 support in the command-line interface	342
Configure a WAN for IPv6	346
Configure a LAN for IPv6	347
Show and update the IPv6 source IP address policy table	350
Show DHCPv6 server status	351
Show DHCPv6 client status	352
Use DHCPv6 to learn IPv6 addresses	353
Use the Neighbor Discovery Protocol (NDP) cache	354
Delete a Neighbor Discovery Protocol (NDP) cache	355
Show the IPv6 routing table	356
Show IPv6 routing and address information	357
Show the IPv6 addresses assigned to an interface	358
Support for IPv6 packets in firewall rules	359
Configure PPP and external modems	360
Configure external modem support	361
Configure PPP mappings	363
Configure PPP parameters	367
Configure mobile PPP parameters	376
Configure advanced PPP parameters	377
Configure PPP negotiation	389
Configure PPP sub-configurations	396
Configure PPP over Ethernet	398

Configuring DHCP servers

About DHCP servers	400
Configure DHCP server for Ethernet interfaces	401
Configure advanced DHCP parameters	404
Configure advanced DHCP options	405
Configure DHCP options	407
Configure static lease reservations	409

Configuring network services

Configure network services	412
----------------------------------	-----

Configuring DNS

Configure DNS servers	418
DNS Server n parameters	418
DNS Server Update parameters	419
Configure Dynamic DNS (DynDNS)	423

Dynamic DNS parameters	423
Advanced Dynamic DNS parameters	426

Configuring IP routing and forwarding

Supported routes	429
Dynamic routes	429
Static routes	429
Default routes	429
Routing modes	429
View the TransPort routing table	431
Configure route metrics	432
Configure IP routing parameters	433
Configure static routes	436
Advanced Static Route parameters	437
Related CLI commands	440
Configure default IP routes	444
Advanced Default route parameters	445
Configure Routing Information Protocol (RIP) settings	450
Configure global RIP Settings	450
Configure access lists	451
Configure authentication keys	452
Configure RIP advertisements	453
Configure Open Shortest Path First (OSPF) parameters	456
Configure Border Gateway Protocol (BGP) settings	459
Configure IP port forwarding and static NAT mappings	461
Configure multicast routes	463
Configure Virtual Routing and Forwarding (VRF)	465
Support for Virtual Routing and Forwarding in the web and command-line interfaces	465
Configure VRF for Ethernet interfaces	465
Configure VRF for GRE tunnel interfaces	465

Configuring Virtual Private Networking (VPN)

Virtual Private Networks (VPNs)	468
Configure Internet Protocol security (IPsec)	469
About Internet Protocol Security (IPSec)	470
Configure IPsec tunnels	472
Configure IPsec tunnel default action	486
Configure IPsec groups	488
Configure Dead Peer Detection (DPD)	497
Configure Internet Key Exchange (IKE)	499
Configure IKEv2	510
Configure Layer 2 Tunneling Protocol (L2TP)	516
Use X.509 certificates with IPsec tunnels	521
Configure Point-to-Point Tunneling Protocol (PPTP)	524
Configure OpenVPN	526
Additional information on OpenVPN configuration	526
Supported Cipher and Digest values for OpenVPN	533

Configuring Secure Sockets Layer (SSL)

About the Secure Sockets Layer (SSL)	535
--	-----

Configure the SSL server	536
Configure SSL clients	538

Configuring Secure Shell (SSH) server and client

About the Secure Shell (SSH) server	541
Configure SSH servers	542
Configure the SSH client	547
Generate SSH private keys	552
Perform SSH authentication with a public/private key pair	554

Configuring FTP Relay

Configure FTP Relay	556
Configure FTP Relay agents	556
Configure Advanced FTP Relay parameters	559
Configure an SMTP client, as needed	560

Configuring IP passthrough

Configure IP passthrough	562
--------------------------------	-----

Configuring UDP echo

Configure a UDP echo client	566
-----------------------------------	-----

Configuring Quality of Service (QoS)

Configure Quality of Service (QoS)	569
--	-----

Configuring time bands

Configure a time band	577
Enable and disable time bands for a PPP or Wi-Fi interface	579

Configuring advanced network settings

Configure advanced network settings	582
Configure first settings group	582

Configuring legacy protocols

About legacy protocols	589
Configure Systems Network Architecture over IP (SNAIP)	590
Forcing SNAIP to use a specific instance	597
Configure TPAD parameters	598
Set TPAD parameters:	603
Configure X.25 parameters	612
Configure general X.25 parameters	613
Configure X.25 LAPB parameters	615

Configure NUI mappings	620
Configure NUA / NUI interface mappings	621
Configure X.25 call macros	624
Configure IP to X.25 call strings	626
Configure Packet Assembler Disassembler (PADS)	629
Configure an X.25 Permanent Virtual Circuit (PVC)	644
X.25 packet switching	647
Configure a MODBUS gateway	656
Requirements for MODBUS support in TransPort devices	656
Configure the MODBUS gateway	656
Configure MODBUS slaves	658
Configure Protocol Switch software	660
Protocol Switch software logic	662
Configure the Protocol Switch	664
Configure CUD mappings parameters	672
Configure IP sockets to protocol switch	673
Configure NUA to interface mappings	676
Configure NUA mappings	678

Configuring alarms

Configure events to trigger alarms	680
Configure sending email alert messages when events occur	682
Configure SNMP traps	687
Send SMS alert messages when events occur	690
Log events to a secondary log file on an external flash drive	692
Log events to a Syslog server	693
Edit event descriptions	696
Configure event logcodes	698
Configure handling of the reasons for an event	701
Configure an SMTP email account to send alarms	703

Configuring system settings

Set device identity parameters	707
Set system date and time	709
Using NTP is recommended for greater accuracy	709
Set system date and time manually	709
Set system date and time automatically using an SNTP server	711
Set system date and time automatically using an NTP server	713
ntpstat command: Check NTP client status	719
Set commands to run automatically at bootup	720
Set web and command line interface options	721
Set miscellaneous system options	724
Set power control options	726
Functional areas for saving power	726
Power control profiles	726
Additional information on power control	727
Set temperature monitoring	730

Configuring remote management

Use Digi Remote Manager to manage devices	732
---	-----

Configure Digi Remote Manager	733
Configure using SMS messages for remote management	735
Enable device health reporting	737
Configure advanced remote management settings	739
Use SNMP for remote management	742
Supported SNMP versions	742
Supported Management Information Bases (MIBs)	742
at\smib commands	742
Configure SNMP settings	743
Configure SNMP users	744
Configure SNMP filters	746
Configure SNMP traps	747

Configuring security

Configure system security settings	751
Configure user security settings	753
Configure advanced user settings	755
Change the default user name and password for a user	757
Firewall	758
Configure firewall rules	759
Configure stateful inspection settings	761
Use firewall scripts	763
Use a RADIUS client for authentication	800
Configure advanced RADIUS client parameters	803
Use TACACS+ to control access to the router	804
Functions of the AAA services	804
TACACS+ to local privilege level mappings	805
Configure advanced TACACS+ security settings	808
Use command filtering	809
Enable command filtering	810
Set calling numbers to answer or reject	811

Configuring telemetry (GPS)

Configure GPS parameters	814
Configure WR31 Cellular GPS	819
Configure GPS support for the GOBI3000 module	821

Managing applications and programs

Manage ScriptBasic applications	822
Manage Python applications	824

Managing networks and connections

Show network interface status	826
Show Ethernet status and statistics	827
Show Wi-Fi status and statistics	830
Show mobile status and statistics	833
Show DSL status and statistics	839
Show GRE interface status	842
Show ISDN status and statistics	844

Show PSTN interface status and statistics	845
Show serial status and statistics	847
Show PPP status and statistics	849
Show IP statistics	853
Show the IP routing table	855
Show the IP hash table	857
Show the port forwarding table	859
Show firewall statistics	860
Show firewall trace output	863
Show DHCP status	864
Show DNS status	865
Show IGMP status	866
Show Quality of Service (QoS) status	867
Show NTP status	868
Manage connections	870
Show IP connections	871
Manage PPP connections	874
Show VPN connections	875
Show GPS data	880
View and manage the event log	882
Analyze data traffic	884
Capture data traffic	885
Show captured data traffic	891
Set PCAP (such as Wireshark) traces	892
Use the Top Talkers monitor	893
Configure Top Talkers monitor	894
Show the Top Talkers trace	895

Performing device administration tasks

View system information	896
Manage files	899
FLASH directory	899
WEB Directory	900
File Editor	901
copy command: Copy a file	902
del command: Delete a file	903
dir command: List the file directory	903
fattr command: Set or remove read only flag for a file	904
flock command: Lock files	904
funlock command: Unlock files	904
move command: Move a file	904
ren command: Rename a file	905
scan/scanr command: Scan the file system	905
type command: Display a text file	905
xmodem command: Initiate an XMODEM file upload	905
TransPort file system	907
Manage files using USB storage devices	909
Create a universal config.da0 file using tags	917
Use comments in configuration files	918
Manage X.509 certificates and host key pairs	919
Manage Certificate Authorities (CAs)	920
Manage IPsec/SSH/HTTPS certificates	922
Manage RSA key files	927
Generate private keys	928

Split a private key	930
Back up and restore configuration settings	931
Configuration files associated with your TransPort router	931
Methods for saving configuration files	931
Back up the configuration to a file on your PC or a server	932
Restore the configuration to a file on your PC or a server	932
Update firmware	933
Reset the router to factory defaults	935
Using the web interface	935
Using the reset button on the router	936
Save configuration settings to a file	937
Save the current configuration	937
Save All: Save the entire configuration	937
Execute a command from the web interface	939
Reboot the router	940

Troubleshooting

Troubleshooting resources	942
Download the debug.txt file	943
Cannot open the web interface	945
Cannot log into the web interface	946
Troubleshoot the LTE-MIMO antenna orientation	947
Network start verbose call end reasons	947

Digi TransPort[®] routers

The Digi TransPort WR family of 3G/4G cellular routers offers an all-in-one mobile communications solution with true enterprise class routing, security and firewall. These multifunction cellular routers feature a flexible design with optional integrated Wi-Fi access point (with multi SSID) / client, USB, serial, VDSL, 1-, 2- or 4-port Ethernet switch with VLAN. Additional configuration options include multiple serial ports (async or sync), GPS or telemetry I/O.

The Digi TransPort family offers an advanced routing, security and firewall feature set including stateful inspection firewall and integrated VPN. Enterprise class protocols incorporate BGP, OSPF and VRRP+, a patented technology built upon the popular VRRP failover standard providing true auto-sensing, auto-failure and auto-recovery of any line drop.

Digi TransPort WR routers are ideal for transportation, POS, energy, medical, financial and digital signage as well as cellular backup and remote device connectivity applications.

Digi management solutions provide easy setup, configuration and maintenance of large installations of remote Digi TransPort devices. Digi Remote Manager offers web-based device management for remote Digi cellular routers and gateways. Digi TransPort routers have the following features:

- Enterprise class cellular routers with advanced dynamic routing, security and firewall features.
- High speed LTE/4G router with fall back to both GSM and CDMA 3G/2G technologies.
- Optional integrated Wi-Fi access point and multiport Ethernet switch.
- Flexible interfaces including serial (async/sync), GPS, VDSL, USB, CAN Bus and telemetry I/O, with flexible DC power options.
- Powerful integrated end user programming.
- Remote Management via windows remote management software or cloud hosted Remote Manager.

TransPort WR11

Digi TransPort WR11 is a full-featured, cellular router offering the flexibility to scale from basic connectivity applications to enterprise class routing and security solutions. With its high performance architecture, Digi TransPort WR11 is designed for Wide Area Network connectivity including 2.5G, 3G, and 4G networks. The TransPort WR11 XT model has a metal enclosure and allows an extended operating temperature range.



TransPort WR21

Digi TransPort WR21 is a full-featured, cellular router offering the flexibility to scale from basic connectivity applications to enterprise class routing and security solutions. With its high performance architecture, Digi TransPort WR21 is designed for Wide Area Network connectivity including 2.5G/3G/4G networks.

Digi TransPort WR21 is available with a range of Ethernet, Serial (RS232, RS422/485), and Power connector options.

Digi TransPort WR21 also offers an optional advanced routing, security, and firewall feature set including stateful inspection firewall and integrated VPN. Enterprise class protocols incorporate BGP, OSPF, and VRRP+, a patented technology built upon the popular VRRP failover standard providing true auto sensing, auto failure, and auto recovery of any line drop.



TransPort WR31

Digi's TransPort WR31 is an intelligent 4G LTE router designed for critical infrastructure and industrial applications.



Key features of the TransPort WR31 include:

- Global HSPA+ and 4G LTE support and certification on major carrier networks around the world.
- Software defined multi-carrier networking with Gobi 4G LTE, meaning one device that operates in 2G, 3G, or 4G across all major North American carriers.
- Ethernet, serial, and I/O for connecting diverse field assets.
- Extremely resilient cellular connection through Digi's patented SureLink™, VRRP+ protocol, and dual SIM slots.
- Enterprise Routing features for security, logging, and redundancy (e.g. stateful firewall, VPN, SNMP); no annual enterprise software license required.
- GPS capabilities are available for GPS-enabled models.
- Digi Remote Manager provides mass configuration, device management, and troubleshooting tools.
- Rugged aluminum enclosure, optimized for Din rail or shelf mounting.
- Optional weatherproof enclosure.
- 5 year warranty standard—no additional cost.

The TransPort WR31 provides a secure, reliable connection to industrial controllers, process automation equipment, and smart grid assets on third party sites or remote locations. This drop-in connectivity gives operators a way to reduce the cost of downtime and service calls and also increase revenue by bringing distributed sites online faster.

The TransPort WR31 is ideal for connecting the following:

- Building and process automation controllers
- Smart grid assets (meters, switches, controllers)
- IP Cameras and access controllers
- Remote data loggers, flow meters, and sensing equipment
- Telco infrastructure
- Traffic and obstruction lighting

TransPort WR41

The Digi TransPort WR family of cellular routers offers an all-in-one mobile communications solution with true enterprise class routing, security, and firewall. These multifunction cellular routers feature a flexible design with an optional integrated Wi-Fi access point (with multi SSID) / Client, USB, serial, and Ethernet, as well as a variety of configuration options including multiple serial ports (async or sync), GPS or I/O telemetry modules.

The Digi TransPort family also offers an advanced routing, security, and firewall feature set including stateful inspection firewall and integrated VPN. Enterprise class protocols incorporate BGP, OSPF, and VRRP+, a patented technology built upon the popular VRRP failover standard providing true auto sensing, auto failure and auto recovery of any line drop.

Digi TransPort WR routers are ideal for transportation and mobile applications. Flexible power options include AC, DC and 4-pin Molex connectors for direct integration into vehicle applications.

Also available is the Digi Remote Manager™, which provides easy setup, configuration, and maintenance of large installations of Digi TransPort devices.



TransPort WR44 / WR44 R



The Digi TransPort WR44 cellular router is an all-in-one mobile communications solution with true enterprise-class routing, security, and firewall. This multifunction cellular router features a flexible design with integrated Wi-Fi access point, USB, serial, and 4-port Ethernet switch, as well as a variety of configuration options including multiple serial ports (async or sync) and GPS or I/O telemetry modules.

The Digi TransPort family offers an advanced routing, security and firewall feature set including stateful inspection firewall and integrated VPN. Enterprise-class protocols incorporate BGP, OSPF, and VRRP+, a patented technology built upon the popular VRRP failover standard providing true auto sensing, auto failure and auto recovery of any line drop.

Digi TransPort WR44 is ideal for transportation and mobile applications. Flexible power options include 9-36 VDC barrel or molex connectors for direct integration into vehicle applications. Digi Remote Manager™ provides easy setup, configuration, and maintenance of large installations of Digi TransPort devices.

TransPort WR44 RR

Digi TransPort WR44 RR is a rugged enterprise-class cellular router designed for rail environments. Its rail industry ratings, versatility, security features, and performance make it ideal for applications such as Positive Train Control (PTC), wayside device communications, and on-board passenger Internet access.

Digi TransPort WR44 RR provides a reliable primary high speed cellular network connection or can act as a secure backup connection to the existing railroad network. It features a flexible communications design with 3G/4G multicarrier GSM/CDMA cellular, plus integrated Wi-Fi a/ac/b/g/n access point, serial, and 4-port Ethernet switch. It also features full on-board train certifications, including AREMA C/H and EN50155. Communications interfaces include hardened connectors, including M12 for Ethernet and serial, as well as TNC connectors for antenna connections.

Digi management solutions provide easy setup, configuration, and maintenance of large installations of remote Digi TransPort devices. Digi Remote Manager offers web-based device management for remote Digi cellular routers and gateways.



Hardware features

TransPort WR11 hardware features	24
TransPort WR21 hardware features	36
TransPort WR31 hardware features	47
TransPort WR41 hardware features	67
TransPort WR44 / WR44 R hardware features	79
TransPort WR44 RR hardware features	94
Signal strength indicators	105
Antenna specifications for Wi-Fi 2.4 GHz modules	106

TransPort WR11 hardware features

TransPort WR11 EVDO model



1. **LAN port:** Connects the device to a 10/100 base-T Local Area Network (LAN). The port can perform auto-sensing for speed and wiring, so it can accept straight-through or cross-over cable connections.
2. **Power connector:** This locking power connector connects the device to a power source. The connector should be inserted and rotated to lock in place. Center pin is positive.
3. **LEDs:**
 - **Service LED:** Indicates the presence and level of cellular service running on the device.
 - Off:** No cellular service
 - 1 Blink:** Device is running 1xRTT service
 - 2 Blinks:** Device is running EDVO Rev 0 service
 - 3 Blinks:** Device is running EDVO Rev A service
 - **Signal LED:** Indicates strength of cellular signal.
 - Off:** Poor or No signal. Place the device in a location where it gets a better signal.
 - Amber:** Fair
 - Green:** Good
 - **Power LED**
 - Off:** No power
 - Green:** TransPort device is powered
4. **Cellular antenna connector:** This SMA female connector connects the device's primary cellular antenna.
5. **Reset button:** Resets the router to factory defaults. See [Reset the router to factory defaults](#).

TransPort WR11 HSPA+ model

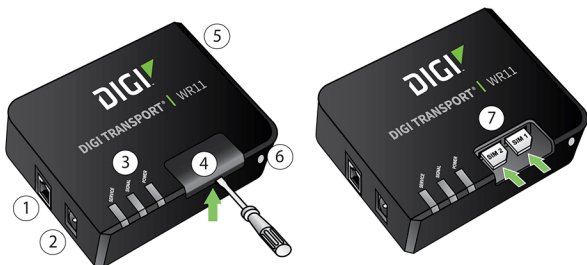

1. **LAN port:** Connects the device to a 10/100 base-T Local Area Network (LAN). The port can perform auto-sensing for speed and wiring, so it can accept straight-through or cross-over cable connections.
2. **Power connector:** This locking power connector connects the device to a power source. The connector should be inserted and rotated to lock in place. Center pin is positive.
3. **LEDs:**
 - **SERVICE LED:** Indicates the presence and level of cellular service running on the device.
 - Off:** No cellular service
 - 1 Blink:** GPRS mode
 - 2 Blinks:** EDGE mode
 - 3 Blinks:** UMTS mode
 - 4 Blinks:** HSDPA mode
 - 5 Blinks:** HSUPA mode
 - **SIGNAL LED:** Indicates strength of cellular signal.
 - Off:** Poor or No signal. Place the device in a location where it gets a better signal.
 - Amber:** Fair
 - Green:** Good
 - **POWER LED:**
 - Off:** No power
 - Green:** TransPort device is powered
4. **SIM door:** Encloses the SIM sockets. The SIM door must be removed to install the SIM cards. For installation details, refer to the Quick Start Guide that came with your device.

Note To remove the SIM door, hold the device on a flat surface and using a screwdriver, firmly pull the cover straight up.

5. **Cellular antenna connector:** This SMA female connector connects the device's primary cellular antenna.
6. **Reset button:** Resets the router to factory defaults. See [Reset the router to factory defaults](#).
7. **SIM Sockets:** **SIM 1** and **SIM 2** are for use with the SIMs.

TransPort WR11 LTE-MIMO



1. **LAN port:** Connects the device to a 10/100 base-T Local Area Network (LAN). The port can perform auto-sensing for speed and wiring, so it can accept straight-through or cross-over cable connections.
2. **Power connector:** This locking power connector connects the device to a power source. The connector should be inserted and rotated to lock in place. Center pin is positive.
3. **LEDs:**
 - **SERVICE LED:** Indicates the presence and level of cellular service running on the device.
 - Off:** No cellular service
 - 1 Blink:** GPRS mode
 - 2 Blinks:** EDGE mode
 - 3 Blinks:** UMTS mode
 - 4 Blinks:** HSDPA mode
 - 5 Blinks:** HSUPA mode
 - 6 Blinks:** LTE mode
 - **SIGNAL LED:** Indicates strength of cellular signal.
 - Off:** Poor or No signal. Place the device in a location where it gets a better signal.
 - Amber:** Fair
 - Green:** Good
 - **POWERLED:**
 - Off:** No power
 - Green:** TransPort device is powered

4. **SIM door:** Encloses the SIM sockets. The SIM door must be opened to install the SIM cards. For installation details, refer to the Quick Start Guide that came with your device.

Note To open the SIM door, slide the SIM door out using your finger.

5. **Reset button:** Resets the router to factory defaults. See [Reset the router to factory defaults](#).
6. **SIM sockets:** **SIM 1** and **SIM 2** are for use with the SIMs.
7. **Primary LTE antenna connector:** This SMA female connector connects the device's primary cellular antenna.
8. **Secondary LTE antenna connector:** This SMA female connector connects the device's secondary cellular antenna.

TransPort WR11 XT



1. **LAN port:** Connects the device to a 10/100 base-T Local Area Network (LAN). The port can perform auto-sensing for speed and wiring, so it can accept straight-through or cross-over cable connections.
2. **Power connector:** This locking power connector connects the device to a power source. The connector should be inserted and rotated to lock in place. Center pin is positive.

3. LEDs:

- **SERVICE LED:** Indicates the presence and level of cellular service running on the device.

Off: No cellular service

1 Blink: GPRS mode

2 Blinks: EDGE mode

3 Blinks: UMTS mode

4 Blinks: HSDPA mode

5 Blinks: HSUPA mode

6 Blinks: LTE mode

- **SIGNAL LED:** Indicates strength of cellular signal.

Off: Poor or No signal. Place the device in a location where it gets a better signal.

Amber: Fair

Green: Good

- **POWER LED:**

Off: No power

Green: TransPort device is powered

4. **SIM door:** Encloses the SIM sockets. The SIM door must be opened to install the SIM cards. For installation details, refer to the Quick Start Guide that came with your device.
5. **Reset button:** Resets the router to factory defaults. See [Reset the router to factory defaults](#).
6. **SIM sockets:** **SIM 1** and **SIM 2** are for use with the SIMs. Insert SIM cards with the notch facing the bottom-right corner of the device. If you are using one SIM card only, insert it in the **SIM 1** slot.
7. **Primary cellular antenna connector:** This SMA female connector connects the device's primary cellular antenna.
8. **Secondary cellular antenna connector:** This SMA female connector connects the device's secondary cellular antenna.

TransPort WR11 accessories

A variety of accessories are available for TransPort products. For the current list of accessories and their Digi part numbers, go to the [TransPort WR11 Part Numbers and Accessories page](#).

TransPort WR11 hardware specifications

[TransPort WR11 specifications](#)

[TransPort WR11 XT specifications](#)

Regulatory and safety statements

RF exposure statement

In order to comply with RF exposure limits established in the ANSI C95.1 standards, the distance between the antenna or antennas and the user should not be less than **20** cm.

FCC Part 15 Class B

Radio Frequency Interference (RFI) (FCC 15.105)

This device has been tested and found to comply with the limits for Class B digital devices pursuant to Part 15 Subpart B, of the FCC rules. These limits are designed to provide reasonable protection against harmful interference in a residential environment. This equipment generates, uses, and can radiate radio frequency energy, and if not installed and used in accordance with the instruction manual, may cause harmful interference to radio communications. However, there is no guarantee that interference will not occur in a particular installation. If this equipment does cause harmful interference to radio or television reception, which can be determined by turning the equipment off and on, the user is encouraged to try and correct the interference by one or more of the following measures:

Reorient or relocate the receiving antenna. Increase the separation between the equipment and receiver. Connect the equipment into an outlet on a circuit different from that to which the receiver is connected. Consult the dealer or an experienced radio/TV technician for help.

Labeling Requirements (FCC 15.19)

This device complies with Part 15 of FCC rules. Operation is subject to the following two conditions: (1) this device may not cause harmful interference, and (2) this device must accept any interference received, including interference that may cause undesired operation.

If the FCC ID is not visible when installed inside another device, then the outside of the device into which the module is installed must also display a label referring to the enclosed module FCC ID.

Modifications (FCC 15.21)

Changes or modifications to this equipment not expressly approved by Digi may void the user's authority to operate this equipment.

TransPort WR11 EU Declaration of Conformity

Digi has issued Declarations of Conformity for the Digi TransPort WR11 concerning emissions, EMC, and safety. For more information, see [Digi government agency certifications page](#).

Important note

Digi customers assume full responsibility for learning and meeting the required guidelines for each country in their distribution market. Refer to the radio regulatory agency in the desired countries of operation for more information.

IFETEL (Mexico)

Some Transport WR11 models are certified for use in Mexico. These models use a pre-approved IFETEL module, as required by IFETEL the certificate number is as follows:

TransPort WR11 Mexico IFETEL Certificate Numbers:

Este equipo contiene el módulo Telit LE910-NA1 con Número IFETEL: RTITEKE17-1320

CE mark (Europe)

The Digi TransPort WR11 is certified for use in several European countries. For information, visit [Digi government agency certifications page](#).

If the Digi TransPort WR11 is incorporated into a product, the manufacturer must ensure compliance of the final product with articles 3.1a and 3.1b of the RE Directive (Radio Equipment Directive). A Declaration of Conformity must be issued for each of these standards and kept on file as described in the RE Directive (Radio Equipment Directive).

Furthermore, the manufacturer must maintain a copy of the Digi TransPort WR11 user manual documentation and ensure the final product does not exceed the specified power ratings, antenna specifications, and/or installation requirements as specified in the user manual. If any of these specifications are exceeded in the final product, a submission must be made to a notified body for compliance testing to all required standards.

OEM labeling requirements

The “CE” marking must be affixed to a visible location on the OEM product.

CE labeling requirements

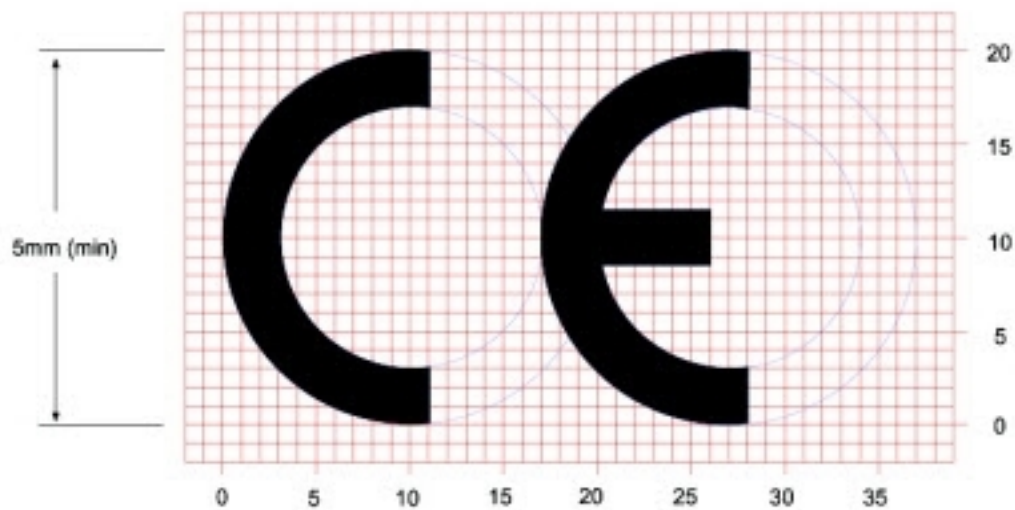

The CE mark shall consist of the initials “CE” taking the following form:

- If the CE marking is reduced or enlarged, the proportions given in the above graduated drawing must be respected.
- The CE marking must have a height of at least 5 mm except where this is not possible on account of the nature of the apparatus.
- The CE marking must be affixed visibly, legibly, and indelibly.

Maximum power and frequency bands

Max power	Frequencies
2 W	Cellular 850 and 900 MHz bands
1 W	Cellular 850 and 900 MHz bands

Innovation, Science, and Economic Development Canada (IC) certifications

This digital apparatus does not exceed the Class B limits for radio noise emissions from digital apparatus set out in the Radio Interference Regulations of the Canadian Department of Communications.

Le présent appareil numérique n'émet pas de bruits radioélectriques dépassant les limites applicables aux appareils numériques de la class B prescrites dans le Règlement sur le brouillage radioélectrique édicté par le ministère des Communications du Canada.

Restricted Access Location notice for Trans Port WR11 XT

Because of the hot metal surface of the enclosure, installations with operating temperatures greater than **122 F (50 C)** must be limited to Restricted Access Locations accessible only to trained service personnel.

Safety notices

1. Please read all instructions before installing and powering the router. You should keep these instructions in a safe place for future reference.
2. If the power supply shows signs of damage or malfunction, stop using it immediately, turn off the power and disconnect the power supply before contacting your supplier for a repair or replacement.
3. Changes or modifications not expressly approved by the party responsible for compliance could void the user's authority to operate the equipment. Use only the accessories, attachments, and power supplies provided by the manufacturer-connecting non-approved antennas or power supplies may damage the router, cause interference or create an electric shock hazard, and will void the warranty.
4. Do not attempt to repair the product. The router contains no electronic components that can be serviced or replaced by the user. Any attempt to service or repair the router by the user will void the product warranty.
5. The TransPort WR11 is designed for indoor use. Use it in an environment suitable for computers and other electronic equipment.
6. Ports that are capable of connecting to other apparatus are defined as SELV ports. To ensure conformity with IEC60950 ensure that these ports are only connected to ports of the same type on other apparatus.

Special notes on safety for wireless routers

Digi International products are designed to the highest standards of safety and international standards compliance for the markets in which they are sold. However, cellular-based products contain radio devices which require specific consideration. Please take the time to read and understand the following guidance. Digi International assumes no liability for an end user's failure to comply with these precautions.



Wireless routers incorporate a wireless radio module. Users should ensure that the antenna(s) is (are) positioned at least 1 meter away from themselves and other persons in normal operation.

When in a hospital or other health care facility, observe the restrictions on the use of mobile phones. Do not use the router in areas where guidelines posted in sensitive areas instruct users to switch off mobile phones. Medical equipment may be sensitive to RF energy.

The operation of cardiac pacemakers, other implanted medical equipment and hearing aids can be affected by interference from cellular terminals such as the wireless routers when placed close to the device. If in doubt about potential danger, contact the physician or the manufacturer of the device to verify that the equipment is properly shielded. Pacemaker patients are advised to keep the wireless router away from the pacemaker while it is on.



Wireless routers must NOT be operated on aircraft. The operation of wireless appliances in an aircraft is forbidden to prevent interference with communications systems. Failure to observe these instructions may lead to the suspension or denial of cellular services to the offender, legal action, or both.



As with any electrical equipment, do not operate the router in the presence of flammable gases, fumes or potentially explosive atmospheres. Do not use radio devices anywhere that blasting operations occur.



Wireless routers receive and transmit radio frequency energy when power is on. Interference can occur when using the router close to TV sets, radios, computers or inadequately shielded equipment. Follow any special regulations and always power off your router wherever forbidden or when it may cause interference or danger.



SOS IMPORTANT! Wireless routers operate using radio signals and cellular networks cannot be guaranteed to connect in all possible conditions. Therefore, never rely solely upon any wireless device for life critical communications.



WARNING! For environments where the temperature is **55° C** or above, this device must be installed in a restricted access area.

Product Disposal Instructions



The WEEE (Waste Electrical and Electronic Equipment: 2002/96/EC) directive has been introduced to ensure that electrical/ electronic products are recycled using the best available recovery techniques to minimize the impact on the environment. This product contains high quality materials and components which can be recycled. At the end of its life this product **MUST NOT** be mixed with other commercial waste for disposal. Check with the terms and conditions of your supplier for disposal information. Digi International Ltd WEEE Registration number: **WEE/HF1515VU**

TransPort WR21 hardware features

TransPort WR21 front panel



1. **SIM/R-UIM sockets (SIM card models only):** **SIM 1** and **SIM 2** are for use with SIMs or R-UIMs (Removable User Identification Modules).
2. **POWER LED:**
 - **Off:** No power
 - **Green:** TransPort device is powered
3. **SERVICE LED:**
 - **Off:** No WWAN network connection
 - **Green:** WWAN network connection
 - **Flashing:** WWAN traffic being transmitted or received
4. **WWAN (Wireless Network) LED:** Indicates the presence and level of cellular service running on the device.
 - **Off:** No cellular service
 - **1 Blink:** GPRS mode
 - **2 Blinks:** EDGE mode
 - **3 Blinks:** UMTS mode
 - **4 Blinks:** HSDPA mode
 - **5 Blinks:** HSUPA mode
 - **6 Blinks:** LTE mode
5. **SIGNAL LED:** Indicate strength of cellular signal.
 - **3 LEDs:** Excellent
 - **2 LEDs:** Good
 - **1 LED:** Fair
 - **0 LEDs:** Poor or No signal
6. **Reset button:** Returns the router to its factory default settings. See [Reset the router to factory defaults](#).
7. **USB host connector:** Connects compatible USB 2.0 client devices such as memory sticks, and serial adapters. The total current available to power USB devices is **0.5 A**.

TransPort WR21 rear panel features

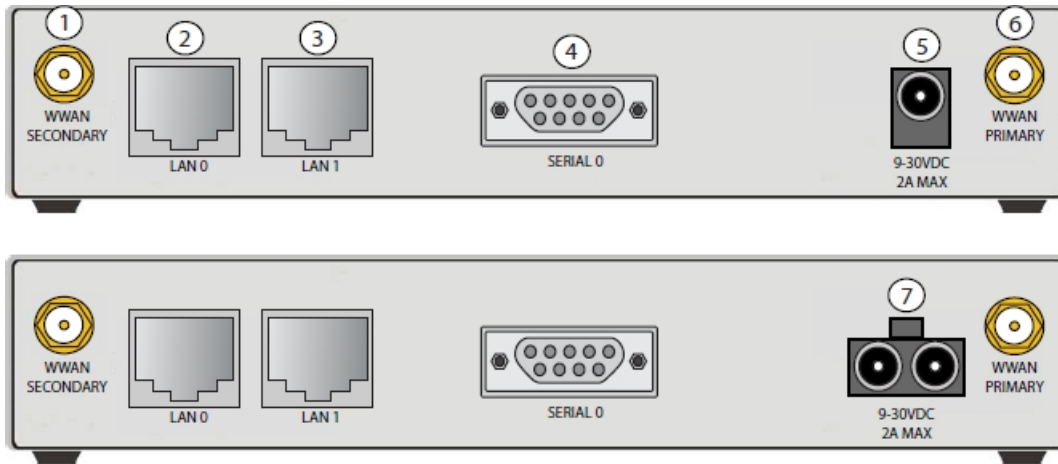

1. **Secondary cellular (WWAN) antenna connector:** This SMA female connector connects the router's secondary cellular antenna. It is highly recommended to use the secondary antenna for diversity. In most circumstances, dual antennas provide improved signal strength and better performance.
2. **LAN 0 port:** This RJ45 port connects the router to a 10/100 base-TLAN. The port is auto-sensing for speed and wiring (straight-through or cross-over).
3. **LAN 1 port (optional):** This RJ45 port connects the router to a 10/100 base-TLAN. The port is auto-sensing for speed and wiring (straight-through or cross-over).
4. **Serial 0 port:** This DB9 port provides an asynchronous RS232 (RS485 optional) serial port with optional RS422/485 support for connecting the router to a compatible serial device. This is a DCE serial port and allows CLI access to the device by default; the baud rate is **115200**. For a pinout, see [TransPort WR21 serial pinout](#).
5. **Power connector:** This connector connects the router to a power source using either the supplied power supply or DC power cord. Secure the barrel plug connector by rotating it by 90 degrees once installed into the Digi TransPort router. Center pin is positive.
6. **Primary cellular (WWAN) antenna connector:** This SMA female connector connects the router's primary cellular antenna.
7. **Power cord input (terminal block variant):** This socket connects the router to an alternative power source.

Reset the TransPort WR21

1. Turn the router on and wait **15** seconds for the router to complete its initialization process.
2. Press and hold the reset button for 5 seconds. The router automatically reboots and displays a pattern of alternating LEDs flashing followed by the normal boot sequence.



CAUTION! Do not remove power from the router during this operation, as corruption of the flash memory may occur.

TransPort WR21 serial pinout

Note that all TransPort serial ports are DCE.

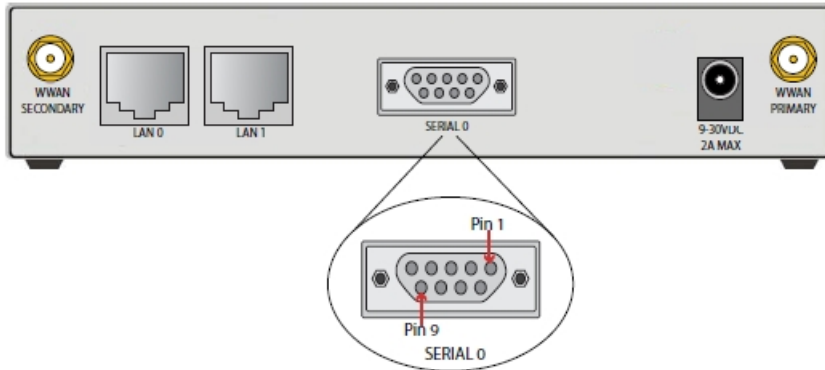

RS232 pinout

Pin #	Direction	RS232 DCE	Description
1	Out	DCD	Data Carrier Detect
2	Out	RXD	Receive Data
3	In	TXD	Transmit Data
4	In	DTR	Data Terminal Ready
5	N/A	GND	Ground
6	Out	DSR	Data Set Ready
7	In	RTS	Ready To Send
8	Out	CTS	Clear To Send
9	Out	RI	Ring Indicate

RS422/RS485 pinout

Pin #	Direction	RS422/ RS485	Description
1	Out	CTS-	Clear To Send -
2	Out	RD+	Receive Data +
3	In	TD+	Transmit Data+
4	In	RTS B RTS-	Ready To Send -
5	N/A	GND	Ground

Pin #	Direction	RS422/ RS485	Description
6	Out	RD-	Receive Data -
7	In	RTS+	Ready To Send +
8	Out	CTS+	Clear To Send +
9	In	TD-	Transmit -

Notes

- For true RS485 mode (2-wire half-duplex mode), the TD+ and RD+ pair and TD- and RD- pair should be connected together.
- The CTS and RTS signals are optional and not normally needed for RS485.

TransPort WR21 accessories

A variety of accessories are available for TransPort products. For the current list of accessories and their Digi part numbers, go to the [TransPort WR21 Part Numbers and Accessories page](#).

TransPort WR21 hardware specifications

[TransPort WR21 hardware specifications](#)

Regulatory and safety statements

RF exposure statement

In order to comply with RF exposure limits established in the ANSI C95.1 standards, the distance between the antenna or antennas and the user should not be less than **20** cm.

FCC Part 15 Class B

Radio Frequency Interference (RFI) (FCC 15.105)

This device has been tested and found to comply with the limits for Class B digital devices pursuant to Part 15 Subpart B, of the FCC rules. These limits are designed to provide reasonable protection against harmful interference in a residential environment. This equipment generates, uses, and can radiate radio frequency energy, and if not installed and used in accordance with the instruction manual, may cause harmful interference to radio communications. However, there is no guarantee that interference will not occur in a particular installation. If this equipment does cause harmful interference to radio or television reception, which can be determined by turning the equipment off and on, the user is encouraged to try and correct the interference by one or more of the following measures:

Reorient or relocate the receiving antenna. Increase the separation between the equipment and receiver. Connect the equipment into an outlet on a circuit different from that to which the receiver is connected. Consult the dealer or an experienced radio/TV technician for help.

Labeling Requirements (FCC 15.19)

This device complies with Part 15 of FCC rules. Operation is subject to the following two conditions: (1) this device may not cause harmful interference, and (2) this device must accept any interference received, including interference that may cause undesired operation.

If the FCC ID is not visible when installed inside another device, then the outside of the device into which the module is installed must also display a label referring to the enclosed module FCC ID.

Modifications (FCC 15.21)

Changes or modifications to this equipment not expressly approved by Digi may void the user's authority to operate this equipment.

TransPort WR21 EU Declaration of Conformity

Digi has issued Declarations of Conformity for the Digi TransPort WR21 concerning emissions, EMC, and safety. For more information, see [Digi government agency certifications page](#).

Important note

Digi customers assume full responsibility for learning and meeting the required guidelines for each country in their distribution market. Refer to the radio regulatory agency in the desired countries of operation for more information.

IFETEL (Mexico)

Some TransPort WR21 models are certified for use in Mexico. These models use a pre-approved IFETEL module, as required by IFETEL the certificate number is as follows:

TransPort WR21 Mexico IFETEL Certificate Numbers:

Este equipo contiene el módulo Telit LE910-NA V2 con Número IFETEL: RCPTELE17-1296

CE mark (Europe)

The Digi TransPort WR21 is certified for use in several European countries. For information, visit [Digi government agency certifications page](#).

If the Digi TransPort WR21 is incorporated into a product, the manufacturer must ensure compliance of the final product with articles 3.1a and 3.1b of the RE Directive (Radio Equipment Directive). A Declaration of Conformity must be issued for each of these standards and kept on file as described in the RE Directive (Radio Equipment Directive).

Furthermore, the manufacturer must maintain a copy of the Digi TransPort WR21 user manual documentation and ensure the final product does not exceed the specified power ratings, antenna specifications, and/or installation requirements as specified in the user manual. If any of these specifications are exceeded in the final product, a submission must be made to a notified body for compliance testing to all required standards.

OEM labeling requirements

The “CE” marking must be affixed to a visible location on the OEM product.

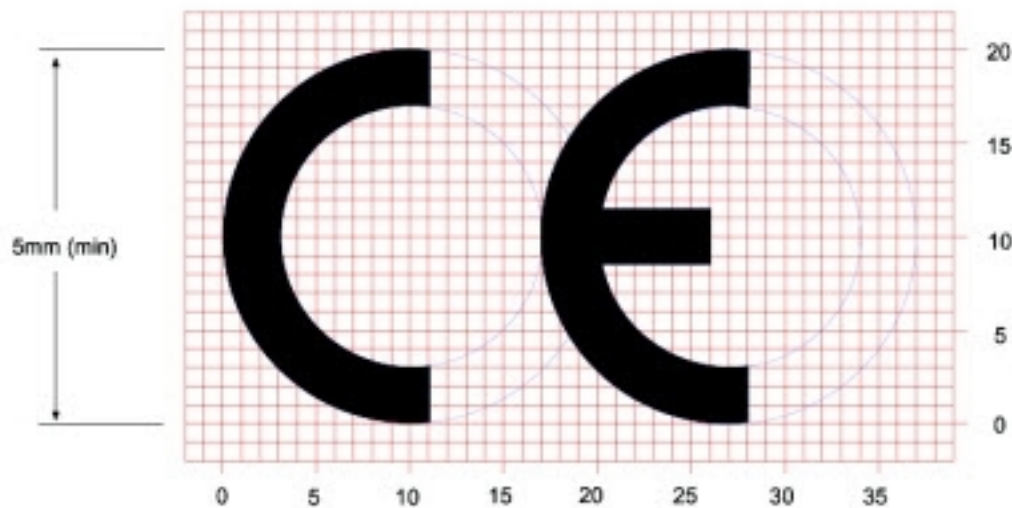
CE labeling requirements

The CE mark shall consist of the initials “CE” taking the following form:

- If the CE marking is reduced or enlarged, the proportions given in the above graduated drawing must be respected.
- The CE marking must have a height of at least 5 mm except where this is not possible on account of the nature of the apparatus.
- The CE marking must be affixed visibly, legibly, and indelibly.

Maximum power and frequency bands

Max power	Frequencies
2 W	Cellular 850 and 900 MHz bands
1 W	Cellular 1800 and 1900 MHz Bands
200 mW	Cellular @450 MHz Band

Innovation, Science, and Economic Development Canada (IC) certifications

This digital apparatus does not exceed the Class B limits for radio noise emissions from digital apparatus set out in the Radio Interference Regulations of the Canadian Department of Communications.

Le présent appareil numérique n'émet pas de bruits radioélectriques dépassant les limites applicables aux appareils numériques de la class B prescrites dans le Règlement sur le brouillage radioélectrique édicté par le ministère des Communications du Canada.

Hazardous Location installation information for TransPort WR21

For Hazardous Location installation, see the *TransPort WR21 Hazardous Location User Guide* (Digi part number 90001532).

Safety notices

1. Please read all instructions before installing and powering the router. You should keep these instructions in a safe place for future reference.
2. If the power supply shows signs of damage or malfunction, stop using it immediately, turn off the power and disconnect the power supply before contacting your supplier for a repair or replacement.
3. Changes or modifications not expressly approved by the party responsible for compliance could void the user's authority to operate the equipment. Use only the accessories, attachments, and power supplies provided by the manufacturer-connecting non-approved antennas or power supplies may damage the router, cause interference or create an electric shock hazard, and will void the warranty.
4. Do not attempt to repair the product. The router contains no electronic components that can be serviced or replaced by the user. Any attempt to service or repair the router by the user will void the product warranty.
5. The TransPort WR21 is designed for indoor use. Use it in an environment suitable for computers and other electronic equipment.
6. Ports that are capable of connecting to other apparatus are defined as SELV ports. To ensure conformity with IEC60950 ensure that these ports are only connected to ports of the same type on other apparatus.

Special notes on safety for wireless routers

Digi International products are designed to the highest standards of safety and international standards compliance for the markets in which they are sold. However, cellular-based products contain radio devices which require specific consideration. Please take the time to read and understand the following guidance. Digi International assumes no liability for an end user's failure to comply with these precautions.



Wireless routers incorporate a wireless radio module. Users should ensure that the antenna(s) is (are) positioned at least 1 meter away from themselves and other persons in normal operation.

When in a hospital or other health care facility, observe the restrictions on the use of mobile phones. Do not use the router in areas where guidelines posted in sensitive areas instruct users to switch off mobile phones. Medical equipment may be sensitive to RF energy.

The operation of cardiac pacemakers, other implanted medical equipment and hearing aids can be affected by interference from cellular terminals such as the wireless routers when placed close to the device. If in doubt about potential danger, contact the physician or the manufacturer of the device to verify that the equipment is properly shielded. Pacemaker patients are advised to keep the wireless router away from the pacemaker while it is on.



Wireless routers must NOT be operated on aircraft. The operation of wireless appliances in an aircraft is forbidden to prevent interference with communications systems. Failure to observe these instructions may lead to the suspension or denial of cellular services to the offender, legal action, or both.



As with any electrical equipment, do not operate the router in the presence of flammable gases, fumes or potentially explosive atmospheres. Do not use radio devices anywhere that blasting operations occur.



Wireless routers receive and transmit radio frequency energy when power is on. Interference can occur when using the router close to TV sets, radios, computers or inadequately shielded equipment. Follow any special regulations and always power off your router wherever forbidden or when it may cause interference or danger.



SOS IMPORTANT! Wireless routers operate using radio signals and cellular networks cannot be guaranteed to connect in all possible conditions. Therefore, never rely solely upon any wireless device for life critical communications.



WARNING! For environments where the temperature is **55° C** or above, this device must be installed in a restricted access area.

Product Disposal Instruction



The WEEE (Waste Electrical and Electronic Equipment: 2002/96/EC) directive has been introduced to ensure that electrical/ electronic products are recycled using the best available recovery techniques to minimize the impact on the environment. This product contains high quality materials and components which can be recycled. At the end of its life this product **MUST NOT** be mixed with other commercial waste for disposal. Check with the terms and conditions of your supplier for disposal information. Digi International Ltd WEEE Registration number: **WEE/HF1515VU**

TransPort WR31 hardware features



1. **SIM card slot cover:** On the underside of the router. Remove and replace with a Phillips-head screwdriver.
2. **SIM 1 and SIM 2 card slots:** On the underside of the router. **SIM 1** and **SIM 2** are for use with . When inserting the SIM card(s) into SIM sockets, **SIM 1** is toward the middle of the router, and **SIM 2** is toward the outside of the router. In both cases, the end of the SIM card with the chamfered corner should be inserted first.
3. **LAN 0 port:** This RJ45 port connects the router to a 10/100 base-TLAN. The port is auto-sensing for speed and wiring (straight-through or cross-over).
4. **LAN 1 port:** This RJ45 port connects the router to a 10/100 base-TLAN. The port is auto-sensing for speed and wiring (straight-through or cross-over).
5. **USB host connector:** Connects compatible USB 2.0 client devices such as memory sticks, and serial adapters. The total current available to power USB devices is 0.5 A.



WARNING! The USB port is for use in a normal location only, not a hazardous location.

6. **Reset button:** Returns the router to its factory default settings. See [Reset the router to factory defaults](#).

7. **Serial connector:** This DB9 port provides an asynchronous RS232 (RS485 optional) serial port with optional RS422/485 support to connect the router to a compatible serial device. This is a DCE serial port and allows CLI access to the device by default; the default serial baud rate is **115200**. For a pinout, see [TransPort WR31 serial pinout](#).
8. **Power connector:** A pluggable connector that connects the router to a power source using either the separately available power supply: Digi part number **76000736**, or a DIN rail power supply.
9. **WWAN primary connector:** This SMA male connector connects the router's primary cellular antenna.
10. **WWAN secondary connector:** This SMA male connector connects the router's secondary cellular antenna. For multiple-input and multiple-output (MIMO), both cellular antennas are needed for downloading data.
Not shown: **GPS antenna connector (GPS models only):** An SMA male connector that connects the router's GPS antenna.
11. **LEDs:** Indicate startup states and status for various signals and services:
 - **POWER LED:**
 - Off:** No power
 - Green:** TransPort device is powered
 - **SERVICE LED:**
 - Off:** No WWAN network connection
 - Green:** WWAN network connection
 - Flashing:** WWAN traffic being transmitted or received
 - **WWAN LED:** Indicates the presence and level of cellular service running on the device.
 - Off:** No cellular service
 - 1 Blink:** GPRS mode
 - 2 Blinks:** EDGE mode
 - 3 Blinks:** UMTS mode
 - 4 Blinks:** HSDPA mode
 - 5 Blinks:** HSUPA mode
 - 6 Blinks:** LTE mode
 - **SIGNAL LEDs:** Indicate strength of cellular signal.
 - 3 LEDs:** Excellent
 - 2 LEDs:** Good
 - 1 LED:** Fair
 - 0 LEDs:** Poor or No signal
 - **SYSTEM LED:** Reserved for user-defined functions.
12. **Earth ground**

13. **Digital/analog I/O connector:** An input/output connector with two digital input/output connections, and a single analog input connection. For more information and wiring diagrams see [TransPort WR31 digital and analog inputs and outputs](#).

TransPort WR31 hardware specifications

[Digi TransPort WR31 specifications](#)

TransPort WR31 accessories

A variety of accessories are available for TransPort products. For the current list of accessories and their Digi part numbers, go to the [TransPort WR31 Part Numbers and Accessories page](#).

TransPort WR31 mounting options

You can mount the TransPort WR31 on a DIN rail, directly to a wall, or in a NEMA enclosure. For DIN Rail mounting, purchase the WR31 DIN Rail Mounting Bracket (Digi part number **76000977**). For wall-mounting or NEMA enclosure installation, purchase the TransPort WR31 Wall Mount Bracket (Digi part number **76000966**) and NEMA enclosure equipment, such as the NEMA enclosure, mounting plate, special cabling, and cable glands.

Hazardous Location installation

For information on installing the TransPort WR31 in a Hazardous Location environment, see the [Digi TransPort WR31 Hazardous Locations User Guide](#).

TransPort WR31 serial pinout

Note that all TransPort serial ports are DCE.

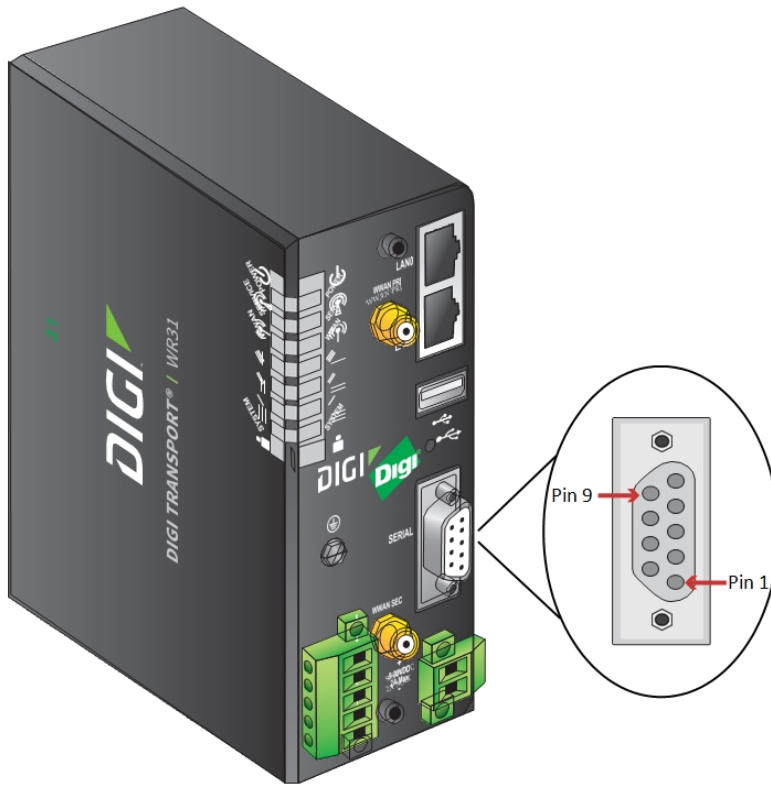

RS232 pinout

Pin #	Direction	RS232 DCE	Description
1	Out	DCD	Data Carrier Detect
2	Out	RXD	Receive Data
3	In	TXD	Transmit Data
4	In	DTR	Data Terminal Ready
5	N/A	GND	Ground
6	Out	DSR	Data Set Ready
7	In	RTS	Ready To Send
8	Out	CTS	Clear To Send
9	Out	RI	Ring Indicate

RS422/RS485 pinout

Pin #	Direction	RS422/ RS485	Description
1	Out	CTS-	Clear To Send -
2	Out	RD+	Receive Data +
3	In	TD+	Transmit Data+
4	In	RTS_B RTS-	Ready To Send -
5	N/A	GND	Ground
6	Out	RD-	Receive Data -
7	In	RTS+	Ready To Send +
8	Out	CTS+	Clear To Send +
9	In	TD-	Transmit -

Notes

- For true RS485 mode (2-wire half-duplex mode), the TD+ and RD+ pair and TD- and RD- pair should be connected together.
- The CTS and RTS signals are optional normally not needed for RS485.

TransPort WR31 digital and analog inputs and outputs

The TransPort WR31 has an input/output connector with two digital input/output connections, and a single analog input connection.

I/O connector pin assignments

The figure and table show the I/O connector, pin assignments, and the signals for each pin.

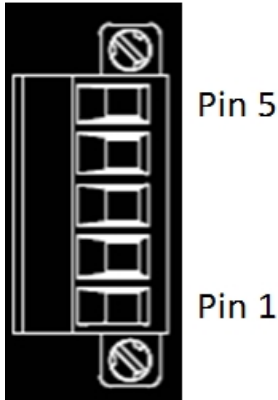

Pin#	Symbol	Description
5	AIN0	Analog Input 0
4	AGND	Analog Return
3	DIO0	Digital I/O 0
2	GND	Digital Return
1	DIO1	Digital I/O 1

TransPort WR31 digital input/output: representative circuit

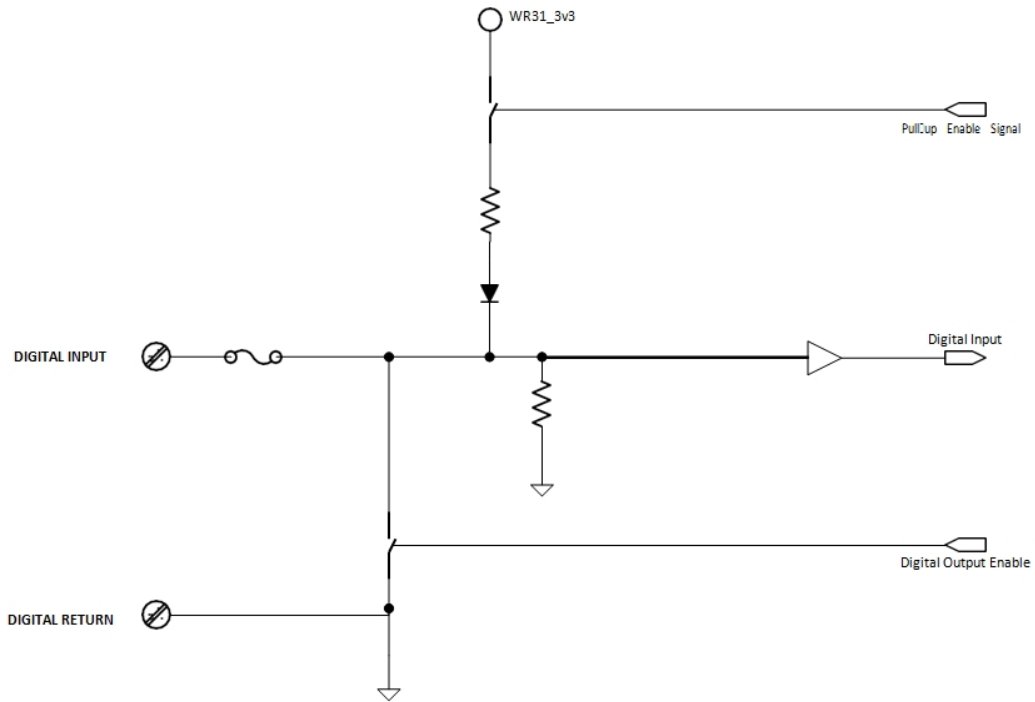

TransPort WR31 analog input: representative circuit

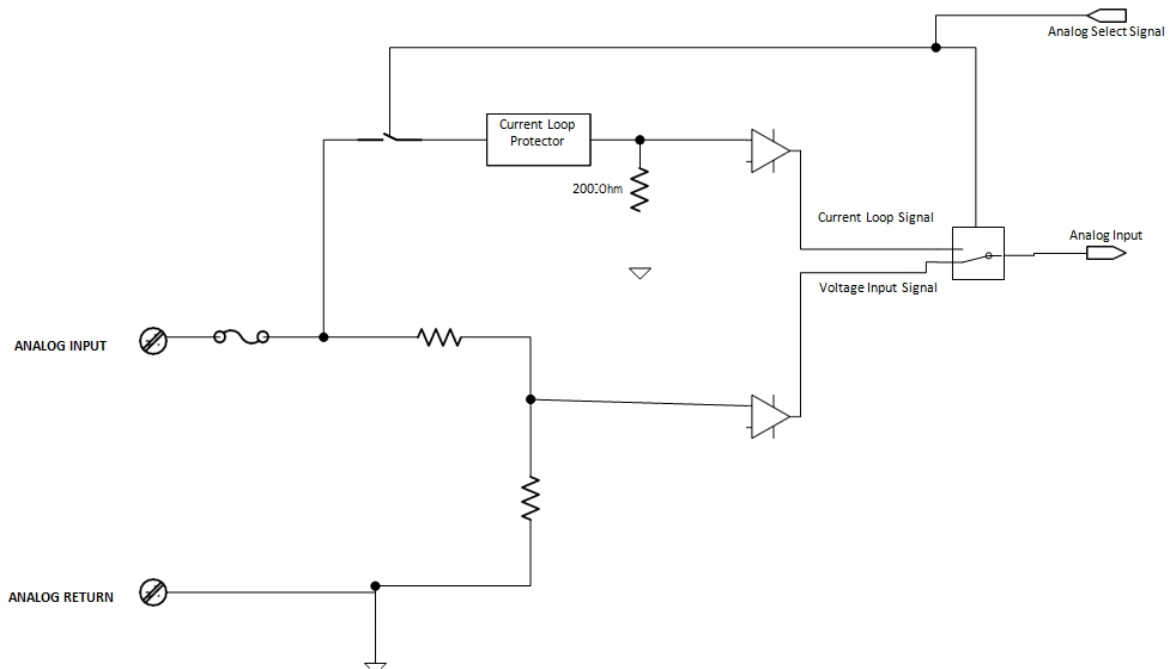

Example digital and analog I/O wiring

Digital input with pullup

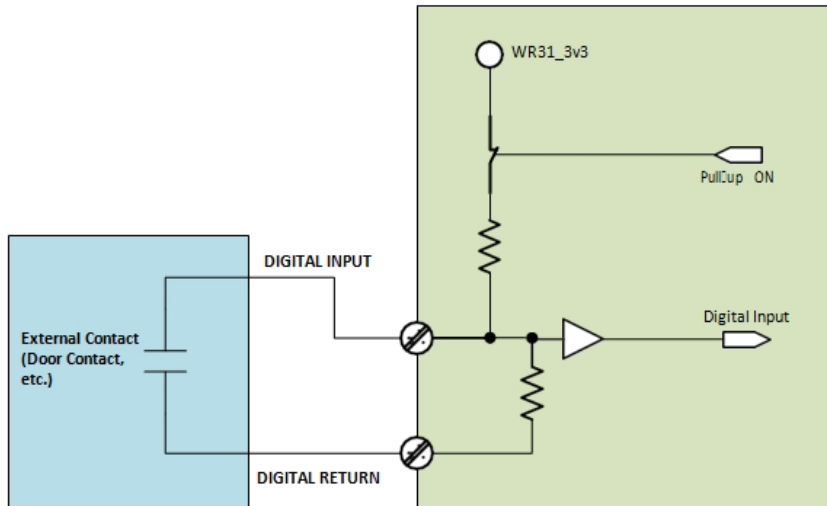

Digital input without pullup

Note that input is **HIGH** when the contact is **CLOSED**.

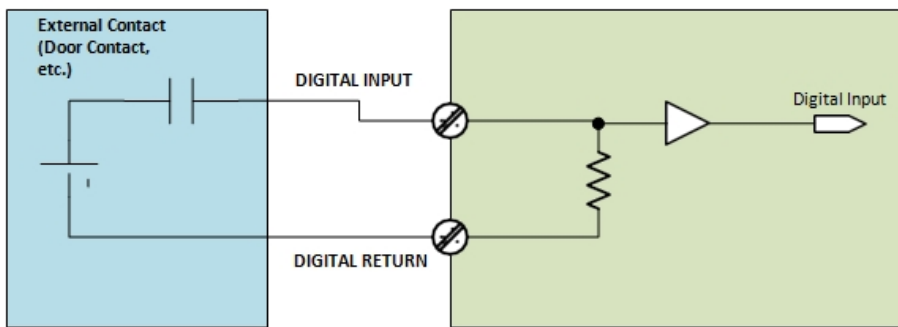

Digital output

The wiring diagram assumes a current-limiting resistor provided by installation or connected device is in use.

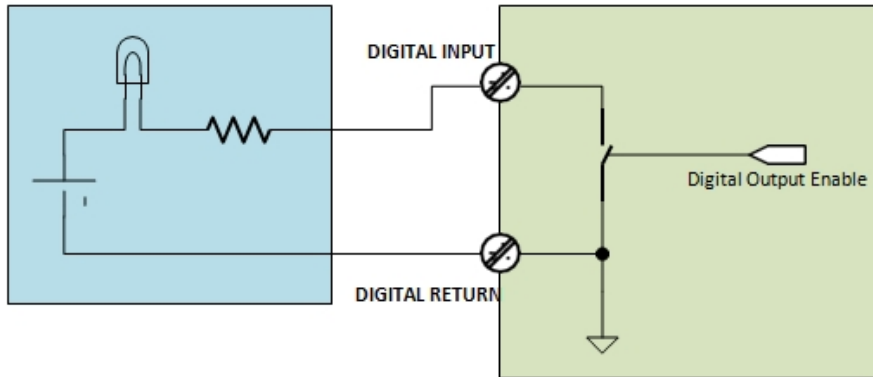

Analog input, 4-20mA input mode

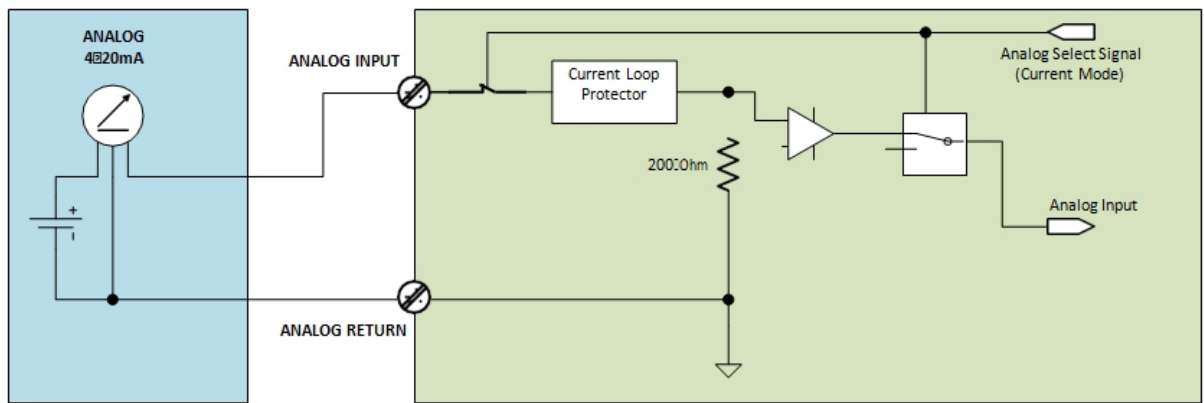

Analog input, 0-10V input mode

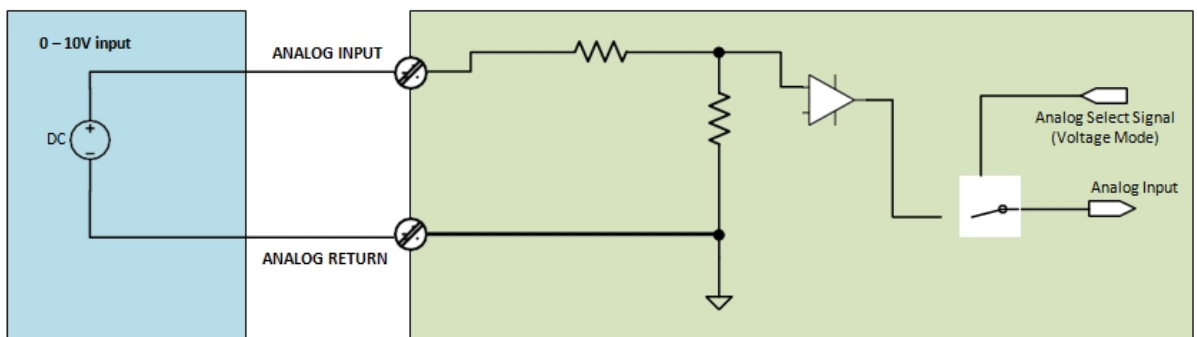

Digital and analog I/O specifications

Digital I/O specifications

Specification	Min	Nom	Max	Units
Rated Input Voltage	-0.2		30	V
Rated Input Current	-1.0		200	mA
Pull-Up Resistance		10 k		Ohms

Digital input specifications

- This input is a non-inverting Schmitt-trigger input.
- The default state at power-up with no voltage applied is **LOW**.

Specification	Min	Nom	Max	Units
+ Threshold	..	1.6	..	V
- Threshold	..	1.0	..	V
Input impedance	..	1 M	..	Ohms

Digital output

- This output is an open-collector, sinking driver output.
- The default state at power-up is **off**.

Specification	Min	Nom	Max	Units
Sink Current	200	mA
Pull-up Voltage		3		V

Analog input specifications

Specification	Min	Nom	Max	Units
Resolution	12	BITS
Accuracy	0.2	%
Rated Input Voltage	-0.2		30	V
Rated Input Current	0		40	mA

Voltage input mode (default)

Specification	Min	Nom	Max	Units
Input Voltage	-0.2	..	10.25	V
Input Impedance	..	291 K	..	Ohms

Current loop mode

Specification	Min	Nom	Max	Units
Minimum Input Voltage	..	2	..	V
Load Resistance	..	200	..	Ohms

Regulatory and safety statements

RF exposure statement

In order to comply with RF exposure limits established in the ANSI C95.1 standards, the distance between the antenna or antennas and the user should not be less than **20** cm.

FCC Part 15 Class B

Radio Frequency Interference (RFI) (FCC 15.105)

This device has been tested and found to comply with the limits for Class B digital devices pursuant to Part 15 Subpart B, of the FCC rules. These limits are designed to provide reasonable protection against harmful interference in a residential environment. This equipment generates, uses, and can radiate radio frequency energy, and if not installed and used in accordance with the instruction manual, may cause harmful interference to radio communications. However, there is no guarantee that interference will not occur in a particular installation. If this equipment does cause harmful interference to radio or television reception, which can be determined by turning the equipment off and on, the user is encouraged to try and correct the interference by one or more of the following measures:

Reorient or relocate the receiving antenna. Increase the separation between the equipment and receiver. Connect the equipment into an outlet on a circuit different from that to which the receiver is connected. Consult the dealer or an experienced radio/TV technician for help.

Labeling Requirements (FCC 15.19)

This device complies with Part 15 of FCC rules. Operation is subject to the following two conditions: (1) this device may not cause harmful interference, and (2) this device must accept any interference received, including interference that may cause undesired operation.

If the FCC ID is not visible when installed inside another device, then the outside of the device into which the module is installed must also display a label referring to the enclosed module FCC ID.

Modifications (FCC 15.21)

Changes or modifications to this equipment not expressly approved by Digi may void the user's authority to operate this equipment.

TransPort WR31 EU Declaration of Conformity

Digi has issued Declarations of Conformity for the Digi TransPort WR31 concerning emissions, EMC, and safety. For more information, see [Digi government agency certifications page](#).

Important note

Digi customers assume full responsibility for learning and meeting the required guidelines for each country in their distribution market. Refer to the radio regulatory agency in the desired countries of operation for more information.

IFETEL (Mexico)

Some Transport WR31 models are certified for use in Mexico. These models use a pre-approved IFETEL module, as required by IFETEL the certificate number is as follows:

TransPort WR31 Mexico IFETEL Certificate Numbers:

Este equipo contiene el módulo Telit LE910-NA V2 con Número IFETEL: RCPTLE17-1296

CE mark (Europe)

The Digi TransPort WR31 is certified for use in several European countries. For information, visit [Digi government agency certifications page](#).

If the Digi TransPort WR31 is incorporated into a product, the manufacturer must ensure compliance of the final product with articles 3.1a and 3.1b of the RE Directive (Radio Equipment Directive). A Declaration of Conformity must be issued for each of these standards and kept on file as described in the RE Directive (Radio Equipment Directive).

Furthermore, the manufacturer must maintain a copy of the Digi TransPort WR31 user manual documentation and ensure the final product does not exceed the specified power ratings, antenna specifications, and/or installation requirements as specified in the user manual. If any of these specifications are exceeded in the final product, a submission must be made to a notified body for compliance testing to all required standards.

OEM labeling requirements

The “CE” marking must be affixed to a visible location on the OEM product.

CE labeling requirements

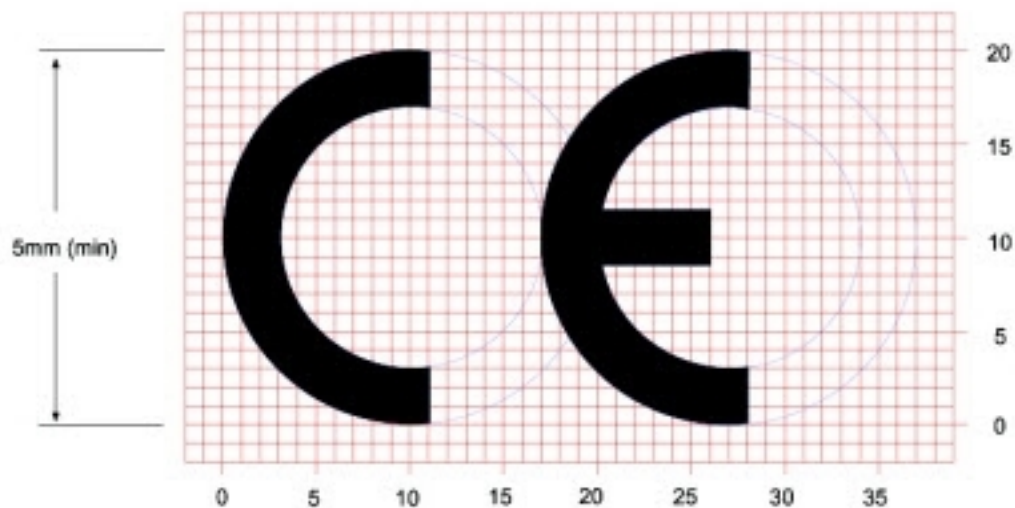

The CE mark shall consist of the initials “CE” taking the following form:

- If the CE marking is reduced or enlarged, the proportions given in the above graduated drawing must be respected.
- The CE marking must have a height of at least 5 mm except where this is not possible on account of the nature of the apparatus.
- The CE marking must be affixed visibly, legibly, and indelibly.

Maximum power and frequency bands

Max power	Frequencies
2 W	Cellular 850 and 900 MHz bands
1 W	Cellular 1800 and 1900 MHz bands
200 mW	Cellular @450 MHz band

Innovation, Science, and Economic Development Canada (IC) certifications

This digital apparatus does not exceed the Class B limits for radio noise emissions from digital apparatus set out in the Radio Interference Regulations of the Canadian Department of Communications.

Le present appareil numerique n'emet pas de bruits radioelectriques depassant les limites applicables aux appareils numeriques de la class B prescrites dans le Reglement sur le brouillage radioelectrique edicte par le ministere des Communications du Canada.

Hazardous Location installation information for TransPort WR31

For information on installing the TransPort WR31 in a Hazardous Location environment, see the [Digi TransPort WR31 Hazardous Locations User Guide](#).

Safety notices

1. Please read all instructions before installing and powering the router. You should keep these instructions in a safe place for future reference.
2. If the power supply shows signs of damage or malfunction, stop using it immediately, turn off the power and disconnect the power supply before contacting your supplier for a repair or replacement.
3. Changes or modifications not expressly approved by the party responsible for compliance could void the user's authority to operate the equipment. Use only the accessories, attachments, and power supplies provided by the manufacturer-connecting non-approved antennas or power supplies may damage the router, cause interference or create an electric shock hazard, and will void the warranty.
4. Do not attempt to repair the product. The router contains no electronic components that can be serviced or replaced by the user. Any attempt to service or repair the router by the user will void the product warranty.
5. The TransPort WR31 is designed for indoor use. Use it in an environment suitable for computers and other electronic equipment.
6. Ports that are capable of connecting to other apparatus are defined as SELV ports. To ensure conformity with IEC60950 ensure that these ports are only connected to ports of the same type on other apparatus.

Special notes on safety for wireless routers

Digi International products are designed to the highest standards of safety and international standards compliance for the markets in which they are sold. However, cellular-based products contain radio devices which require specific consideration. Please take the time to read and understand the following guidance. Digi International assumes no liability for an end user's failure to comply with these precautions.



Wireless routers incorporate a wireless radio module. Users should ensure that the antenna(s) is (are) positioned at least 1 meter away from themselves and other persons in normal operation.

When in a hospital or other health care facility, observe the restrictions on the use of mobile phones. Do not use the router in areas where guidelines posted in sensitive areas instruct users to switch off mobile phones. Medical equipment may be sensitive to RF energy.

The operation of cardiac pacemakers, other implanted medical equipment and hearing aids can be affected by interference from cellular terminals such as the wireless routers when placed close to the device. If in doubt about potential danger, contact the physician or the manufacturer of the device to verify that the equipment is properly shielded. Pacemaker patients are advised to keep the wireless router away from the pacemaker while it is on.



Wireless routers must NOT be operated on aircraft. The operation of wireless appliances in an aircraft is forbidden to prevent interference with communications systems. Failure to observe these instructions may lead to the suspension or denial of cellular services to the offender, legal action, or both.



As with any electrical equipment, do not operate the router in the presence of flammable gases, fumes or potentially explosive atmospheres. Do not use radio devices anywhere that blasting operations occur.



Wireless routers receive and transmit radio frequency energy when power is on. Interference can occur when using the router close to TV sets, radios, computers or inadequately shielded equipment. Follow any special regulations and always power off your router wherever forbidden or when it may cause interference or danger.



SOS IMPORTANT! Wireless routers operate using radio signals and cellular networks cannot be guaranteed to connect in all possible conditions. Therefore, never rely solely upon any wireless device for life critical communications.



WARNING! For environments where the temperature is **55° C** or above, this device must be installed in a restricted access area.

Product Disposal Instructions



The WEEE (Waste Electrical and Electronic Equipment: 2002/96/EC) directive has been introduced to ensure that electrical/ electronic products are recycled using the best available recovery techniques to minimize the impact on the environment. This product contains high quality materials and components which can be recycled. At the end of its life this product **MUST NOT** be mixed with other commercial waste for disposal. Check with the terms and conditions of your supplier for disposal information. Digi International Ltd WEEE Registration number: **WEE/HF1515VU**

TransPort WR41 hardware features

Front panel

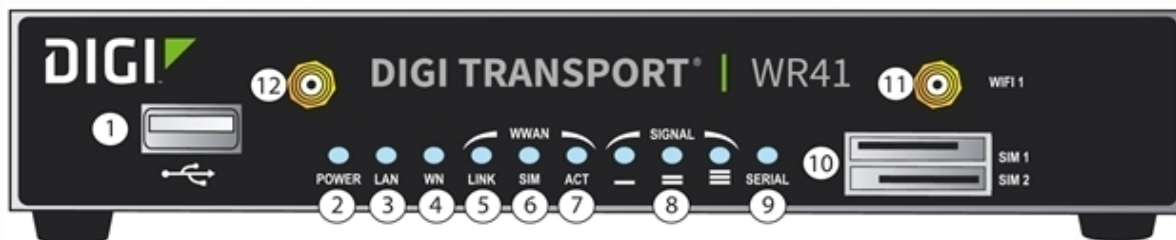

1. **USB host connector:** Connects compatible USB 2.0 client devices such as memory sticks, and serial adapters. The total current available to power USB devices is **0.5 A**.
2. **POWER LED:**
 - **Off:** No power
 - **Green:** TransPort device is powered
3. **LAN LED:** Illuminates steadily when there is a network connection to the **LAN** port and flashes when data is transmitted or received.
4. **WN LED:**
 - **Wi-Fi models:** Illuminates steady if Wi-Fi activity is present.
 - **Non-Wi-Fi models:** Flashes to show which network mode the router is operating in:
 - Off:** No service
 - 1 blink:** GPRS mode
 - 2 blinks:** EDGE mode
 - 3 blinks:** UMTS mode
 - 4 blinks:** HSDPA mode
 - 5 blinks:** HSUPA mode
 - 6 blinks:** LTE mode
5. **LINK LED:** Illuminates steadily when a wireless WAN data connection has been established.
6. **SIM LED:** Illuminates steadily when a valid SIM card is installed.
7. **ACT LED:** Flashes to indicate that data is being transferred over the wireless WAN network.
8. **SIGNAL LEDs:** Indicate strength of cellular signal.
 - **3 LEDs:** Excellent
 - **2 LEDs:** Good
 - **1 LED:** Fair
 - **0 LEDs:** Poor or No signal
9. **SERIAL LED:** Illuminates steady if a terminal is connected to the **SERIAL** port and the DTR signal is on. Flashes when data is transmitted or received.

10. **SIM / R-UIM Sockets (SIM card models only):** **SIM 1** and **SIM 2** are for use with the Subscriber Identification Module(s) (SIMs) or Removable User Identification Module(s) (R-UIMs).
11. **Primary Wi-Fi antenna connector (Wi-Fi models only):** This SMA connector connects the router's primary Wi-Fi antenna.
12. **Secondary Wi-Fi antenna connector (Wi-Fi models only):** This SMA connector connects the router's secondary Wi-Fi antenna.

Rear panel

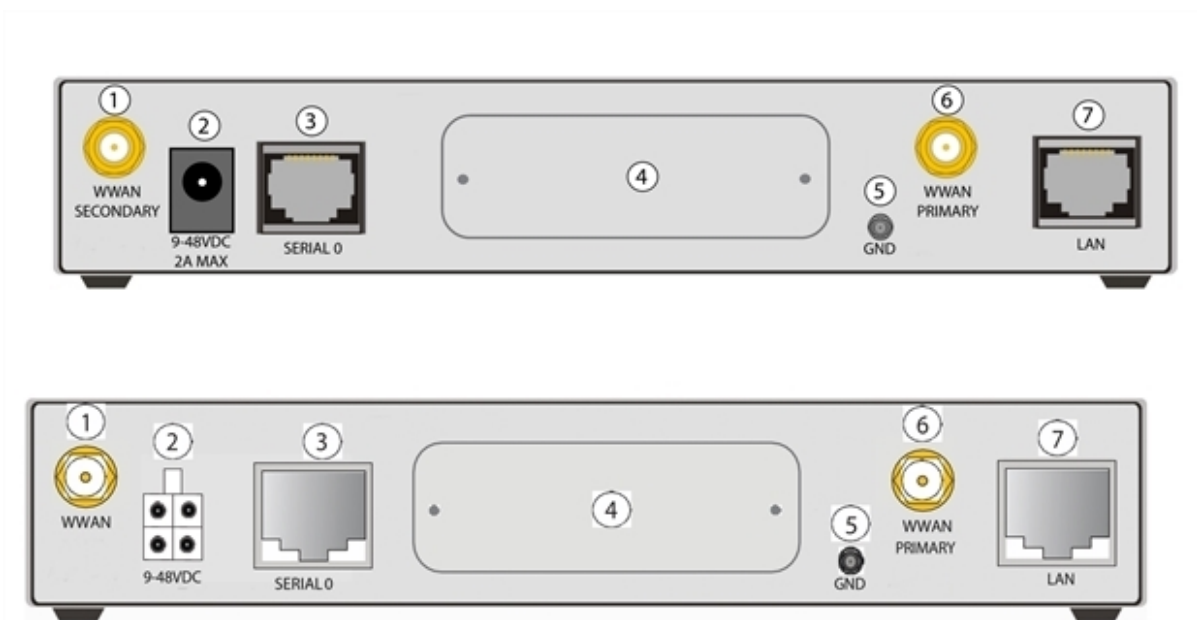

1. **WWAN Secondary Antenna Connector (WR41-U and WR41-C models):** An SMA female connector that connects the unit's secondary cellular antenna. It is highly recommended to use the secondary antenna for diversity. In most circumstances, dual antennas provide improved signal strength and better performance.
2. **Power connector:** Connects the router to a power source. The power cord input can be AC, DC and 4-pin Molex connectors. Secure the barrel plug connector by rotating it by 90 degrees once installed into the Digi TransPort router. Center pin is positive.
3. **Serial 0 Port:** This RJ45 port provides an asynchronous RS232 serial port for connecting the unit to a compatible serial device. This is a DCE serial port and allows CLI access to the device by default; the baud rate is **115200**. See [TransPort WR41 serial pinout](#) for a pinout diagram.
4. **Hardware Expansion Port:** Various hardware upgrades are available for this unit and are populated via this expansion port. See **Additional hardware features** below for further information.
5. **Case Ground:** Connect an additional case ground if necessary.
6. **WWAN Primary Antenna Connector:** An SMA female connector that connects the unit's primary cellular antenna.
7. **LAN Port:** This RJ45 port connects the unit to a 10/100 base-T LAN. The port performs auto-sensing for speed and wiring, and can handle a straight-through or cross-over cable.

Underside of unit features

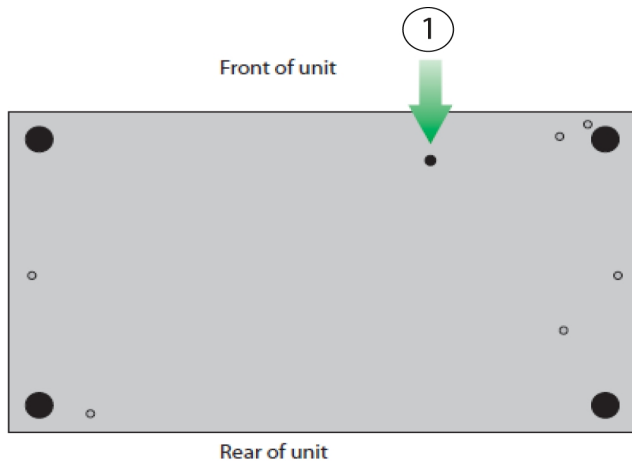

1. **Reset button:** The reset button is on the underside of the unit. It performs a factory reset. It is recessed to avoid an accidental reset. See [Reset the router to factory defaults](#).

Additional hardware features

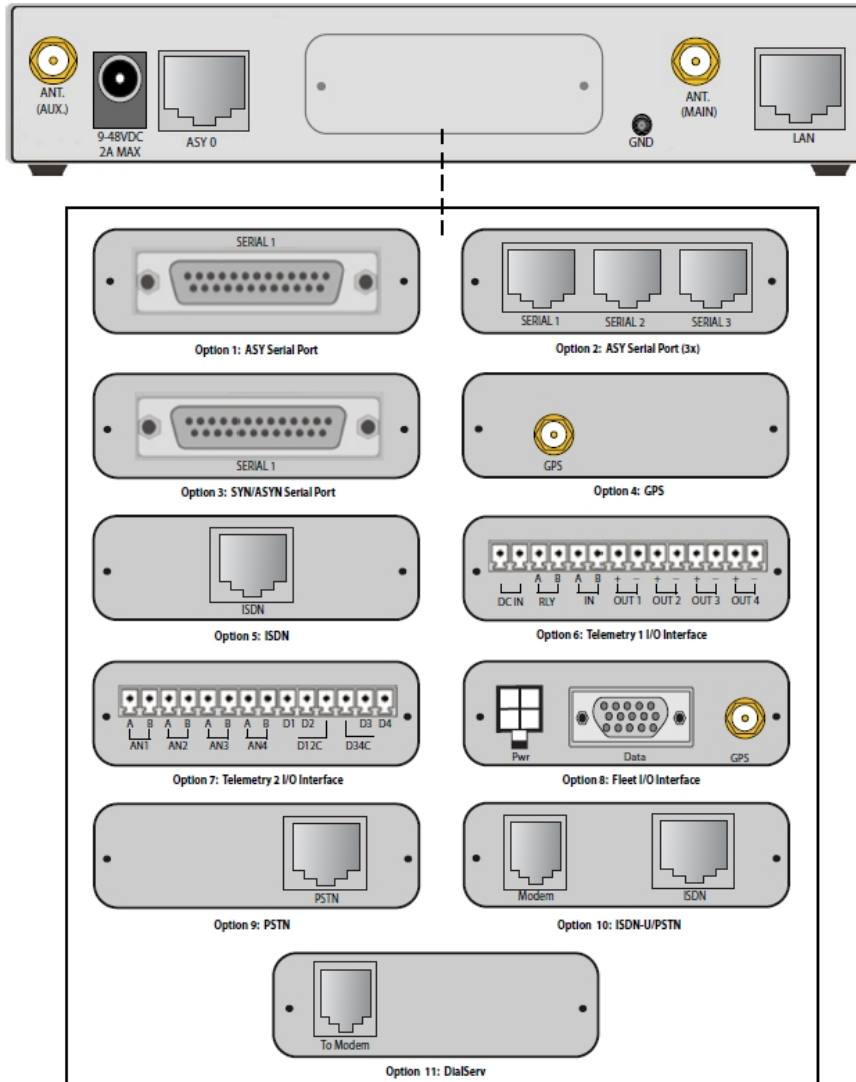

1. **ASY Serial Port:** Provides an additional asynchronous RS232 serial port using a DB25 connector.
2. **ASY Serial Port (3x):** Provides three additional asynchronous RS232 serial ports using RJ45 connectors.
3. **SYN/ASYN Serial Port:** Provides an X.21/RS422/RS232 synchronous / asynchronous serial port using a DB25 connector.
4. **GPS:** Provides GPS capabilities using an SMA male connector.
5. **ISDN:** Provides an ISDN Basic Rate Interface (BRI) via an RJ45 port. This can be configured either as a TE (terminal endpoint) or as NT-1 (network termination). The option also includes an additional asynchronous serial port via a second RJ45 port.

6. **Telemetry 1 I/O Interface:** Provides 4 opto-isolated digital input ports and 1 opto-isolated digital output port. It also provides a relay I/O port, a voltage monitoring port, and internal temperature monitoring.
 7. **Telemetry 2 I/O Interface:** Provides 4 isolated analog I/O ports and 4 non-isolated digital I/O ports.
 8. **Fleet I/O Interface:** Provides a CAN and J1708 interface, GPS, 4 non-isolated digital I/O ports, ignition sense port, and a 3-axis accelerometer.
 9. **PSTN:** Provides a PSTN interface via an RJ45 connector for dialing out and receiving calls.
 10. **ISDN-U/PSTN:** Provides an ISDN-U interface suitable for the USA plus PSTN interface. It can be configured for Bell-103 modulation in leased line mode as well as a normal PSTN interface.
 11. **DialServ:** This RJ11/FXS connection converts a PSTN analog modem to a RS-232 serial signal.
- For more information on the **Telemetry 1 Interface**, **Telemetry 2 Interface**, and the **Fleet I/O Interface**, see the product specific user's guides, available on www.digi.com on the TransPort WR41 **Product Support** page.

TransPort WR41 hardware specifications

[Digi TransPort WR41 specifications](#)

TransPort WR41 accessories

A variety of accessories are available for TransPort products. For the current list of accessories and their Digi part numbers, go to the [TransPort WR41 Part Numbers and Accessories page](#).

TransPort WR41 serial pinout

Note that **all TransPort serial ports are DCE.**

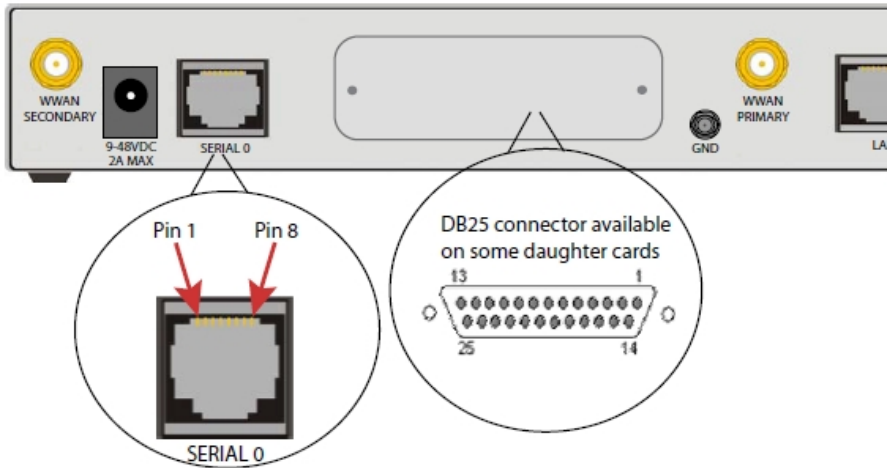

RS232 port pinouts

Description	RS232 signal	Direction	DB 25 Pin#	RJ45 Pin#
Transmit Data	TxD	in	2	6
Receive Data	RxD	out	3	3
Ready To Send	RTS	in	4	1
Clear To Send	CTS	out	5	8
Data Set Ready	DSR	out	6	n/a
Ground	GND	n/a	7	5
Data Carrier Detect	DCD	out	8	7
Transmitter Clock	TxC	out	15	n/a
Receiver Clock	RxC	out	17	n/a
Data Terminal Ready	DTR	in	20	2
Ring Indicate	RI	out	22	n/a
External Transmitter Clock	ETC	in	24	n/a

Regulatory and safety statements

RF exposure statement

In order to comply with RF exposure limits established in the ANSI C95.1 standards, the distance between the antenna or antennas and the user should not be less than **20** cm.

FCC Part 15 Class B

Radio Frequency Interference (RFI) (FCC 15.105)

This device has been tested and found to comply with the limits for Class B digital devices pursuant to Part 15 Subpart B, of the FCC rules. These limits are designed to provide reasonable protection against harmful interference in a residential environment. This equipment generates, uses, and can radiate radio frequency energy, and if not installed and used in accordance with the instruction manual, may cause harmful interference to radio communications. However, there is no guarantee that interference will not occur in a particular installation. If this equipment does cause harmful interference to radio or television reception, which can be determined by turning the equipment off and on, the user is encouraged to try and correct the interference by one or more of the following measures:

Reorient or relocate the receiving antenna. Increase the separation between the equipment and receiver. Connect the equipment into an outlet on a circuit different from that to which the receiver is connected. Consult the dealer or an experienced radio/TV technician for help.

Labeling Requirements (FCC 15.19)

This device complies with Part 15 of FCC rules. Operation is subject to the following two conditions: (1) this device may not cause harmful interference, and (2) this device must accept any interference received, including interference that may cause undesired operation.

If the FCC ID is not visible when installed inside another device, then the outside of the device into which the module is installed must also display a label referring to the enclosed module FCC ID.

Modifications (FCC 15.21)

Changes or modifications to this equipment not expressly approved by Digi may void the user's authority to operate this equipment.

TransPort WR41 EU Declaration of Conformity

Digi has issued Declarations of Conformity for the Digi TransPort WR41 concerning emissions, EMC, and safety. For more information, see [Digi government agency certifications page](#).

Important note

Digi customers assume full responsibility for learning and meeting the required guidelines for each country in their distribution market. Refer to the radio regulatory agency in the desired countries of operation for more information.

CE mark (Europe)

The Digi TransPort WR41 is certified for use in several European countries. For information, visit [Digi government agency certifications page](#).

If the Digi TransPort WR41 is incorporated into a product, the manufacturer must ensure compliance of the final product with articles 3.1a and 3.1b of the RE Directive (Radio Equipment Directive). A

Declaration of Conformity must be issued for each of these standards and kept on file as described in the RE Directive (Radio Equipment Directive).

Furthermore, the manufacturer must maintain a copy of the Digi TransPort WR41 user manual documentation and ensure the final product does not exceed the specified power ratings, antenna specifications, and/or installation requirements as specified in the user manual. If any of these specifications are exceeded in the final product, a submission must be made to a notified body for compliance testing to all required standards.

OEM labeling requirements

The “CE” marking must be affixed to a visible location on the OEM product.

CE labeling requirements

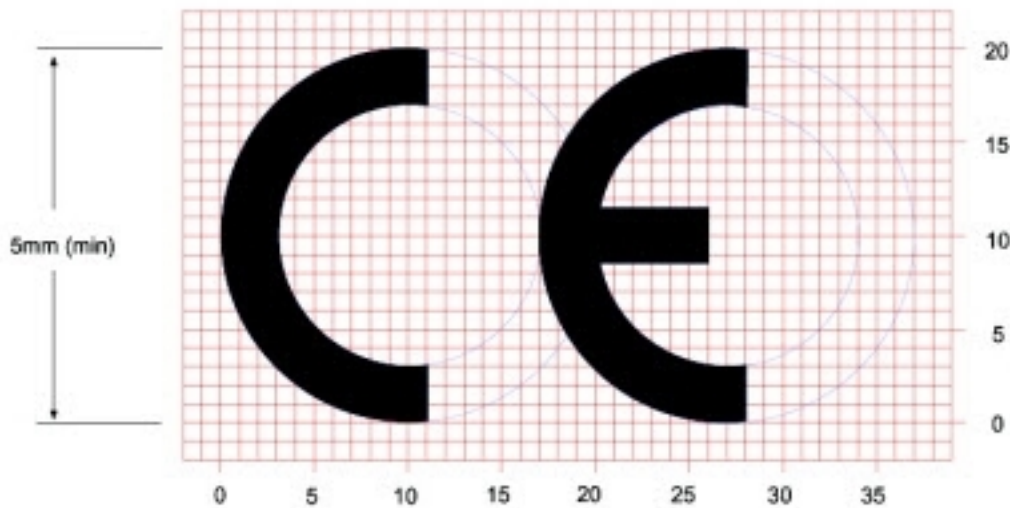

The CE mark shall consist of the initials “CE” taking the following form:

- If the CE marking is reduced or enlarged, the proportions given in the above graduated drawing must be respected.
- The CE marking must have a height of at least 5 mm except where this is not possible on account of the nature of the apparatus.
- The CE marking must be affixed visibly, legibly, and indelibly.

Maximum power and frequency bands

Max power	Frequencies
2 W	Cellular 850 and 900 MHz bands
1 W	Cellular 1800 and 1900 MHz bands

Innovation, Science, and Economic Development Canada (IC) certifications

This digital apparatus does not exceed the Class B limits for radio noise emissions from digital apparatus set out in the Radio Interference Regulations of the Canadian Department of Communications.

Le present appareil numerique n'emet pas de bruits radioelectriques depassant les limites applicables aux appareils numeriques de la class B prescrites dans le Reglement sur le brouillage radioelectrique edicte par le ministere des Communications du Canada.

Safety notices

1. Please read all instructions before installing and powering the router. You should keep these instructions in a safe place for future reference.
2. If the power supply shows signs of damage or malfunction, stop using it immediately, turn off the power and disconnect the power supply before contacting your supplier for a repair or replacement.
3. Changes or modifications not expressly approved by the party responsible for compliance could void the user's authority to operate the equipment. Use only the accessories, attachments, and power supplies provided by the manufacturer-connecting non-approved antennas or power supplies may damage the router, cause interference or create an electric shock hazard, and will void the warranty.
4. Do not attempt to repair the product. The router contains no electronic components that can be serviced or replaced by the user. Any attempt to service or repair the router by the user will void the product warranty.
5. Products in the TransPort WR family are designed for indoor use. Use them in an environment suitable for computers and other electronic equipment.
6. Ports that are capable of connecting to other apparatus are defined as SELV ports. To ensure conformity with IEC60950 ensure that these ports are only connected to ports of the same type on other apparatus.

Special notes on safety for wireless routers

Digi International products are designed to the highest standards of safety and international standards compliance for the markets in which they are sold. However, cellular-based products contain radio devices which require specific consideration. Please take the time to read and understand the following guidance. Digi International assumes no liability for an end user's failure to comply with these precautions.



Wireless routers incorporate a wireless radio module. Users should ensure that the antenna(s) is (are) positioned at least 1 meter away from themselves and other persons in normal operation.

When in a hospital or other health care facility, observe the restrictions on the use of mobile phones. Do not use the router in areas where guidelines posted in sensitive areas instruct users to switch off mobile phones. Medical equipment may be sensitive to RF energy.

The operation of cardiac pacemakers, other implanted medical equipment and hearing aids can be affected by interference from cellular terminals such as the wireless routers when placed close to the device. If in doubt about potential danger, contact the physician or the manufacturer of the device to verify that the equipment is properly shielded. Pacemaker patients are advised to keep the wireless router away from the pacemaker while it is on.



Wireless routers must NOT be operated on aircraft. The operation of wireless appliances in an aircraft is forbidden to prevent interference with communications systems. Failure to observe these instructions may lead to the suspension or denial of cellular services to the offender, legal action, or both.



As with any electrical equipment, do not operate the router in the presence of flammable gases, fumes or potentially explosive atmospheres. Do not use radio devices anywhere that blasting operations occur.



Wireless routers receive and transmit radio frequency energy when power is on. Interference can occur when using the router close to TV sets, radios, computers or inadequately shielded equipment. Follow any special regulations and always power off your router wherever forbidden or when it may cause interference or danger.



SOS IMPORTANT! Wireless routers operate using radio signals and cellular networks cannot be guaranteed to connect in all possible conditions. Therefore, never rely solely upon any wireless device for life critical communications.



WARNING! For environments where the temperature is **55° C** or above, this device must be installed in a restricted access area.

Product Disposal Instructions



The WEEE (Waste Electrical and Electronic Equipment: 2002/96/EC) directive has been introduced to ensure that electrical/ electronic products are recycled using the best available recovery techniques to minimize the impact on the environment. This product contains high quality materials and components which can be recycled. At the end of its life this product **MUST NOT** be mixed with other commercial waste for disposal. Check with the terms and conditions of your supplier for disposal information. Digi International Ltd WEEE Registration number: **WEE/HF1515VU**

TransPort WR44 / WR44 R hardware features

Front panel

TransPort WR44 models with cellular interface



TransPort WR44 models without SIM card slots



1. **USB host connector:** Connects compatible USB 2.0 client devices such as memory sticks and serial adapters. The total current available to power USB devices is 0.5 A.
2. **POWER LED:**
 - **Off:** No power
 - **Green:** TransPort device is powered
3. **LAN (0, 1, 2, 3) LED:** Illuminates steadily when there is a network connection to the LAN port and flashes when data is transmitted or received.
4. **Wi-Fi LED:**
 - **Wi-Fi models:** Illuminates steadily if Wi-Fi activity is present.
5. **SERIAL LED:** Illuminates steadily if a terminal is connected to the SERIAL port and the DTR signal is on. Flashes when data is transmitted or received.
6. **LINK LED:** Illuminates steadily when a wireless data connection has been established.
7. **SIM LED:**
 - **Cellular models:** Illuminates steadily when a valid SIM card is installed.
 - **Models without cellular interface:** Not operational.
8. **ACT LED:** Flashes to indicate that data is being transferred over the wireless network.

9. **SIGNAL LED:**

- **Cellular models:** Indicate strength of cellular signal.

3 LEDs: Excellent

2 LEDs: Good

1 LED: Fair

0 LEDs: Poor or No signal

- **Models without cellular interface:** Not operational.

10. **SIM / R-UIM Sockets:**

- **Cellular SIM card models only:** Illuminates steadily when a valid SIM card is installed.
- **Models without cellular interface:** Not operational or accessible.

Rear panel

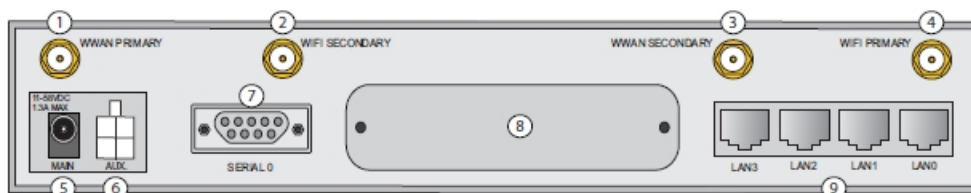

1. **Primary cellular (WWAN) antenna connector:** An SMA female connector that connects the router's primary cellular antenna.
2. **Secondary Wi-Fi (WLAN) Antenna connector (Wi-Fi models only):** An SMA male connector that connects the router's secondary Wi-Fi antenna.
3. **Secondary cellular (WWAN) antenna connector (WR44-U and WR44-C models):** An SMA female connector that connects the router's secondary cellular antenna. It is highly recommended to use the secondary antenna for diversity. In most circumstances, dual antennas will provide improved signal strength thus better performance.
4. **Primary Wi-Fi (WLAN) antenna connector (Wi-Fi models only):** An SMA male connector that connects the router's primary Wi-Fi antenna.
5. **Power connector:** Connects the router to a power source. The power supply has a twist-lock connector which can be secured by rotating it 90 degrees once installed into the TransPort router. Center pin is positive.
6. **9-36 VDC (Aux):** Connects the router to an alternative 11-58VDC power supply (not supplied) using a fused power cable which can be purchased separately. This cable also contains two programmable IO signal lines, one is an input signal, and the other is an input/output signal.
7. **SERIAL 0 port:** This DB9 port provides an asynchronous RS232 serial port for connecting the router to a compatible serial device. This is a DCE serial port and allows CLI access to the device by default; the baud rate is 115200.
8. **Hardware expansion port:** Various hardware upgrades are available for this router and are populated via this expansion port. See [TransPort WR44 additional hardware features](#) for more information.

9. **LAN ports:** Connect the router to a 10/100 base-T LAN. These ports are auto-sensing for speed and wiring (straight-through or cross-over).

Underside of unit

TransPort WR44

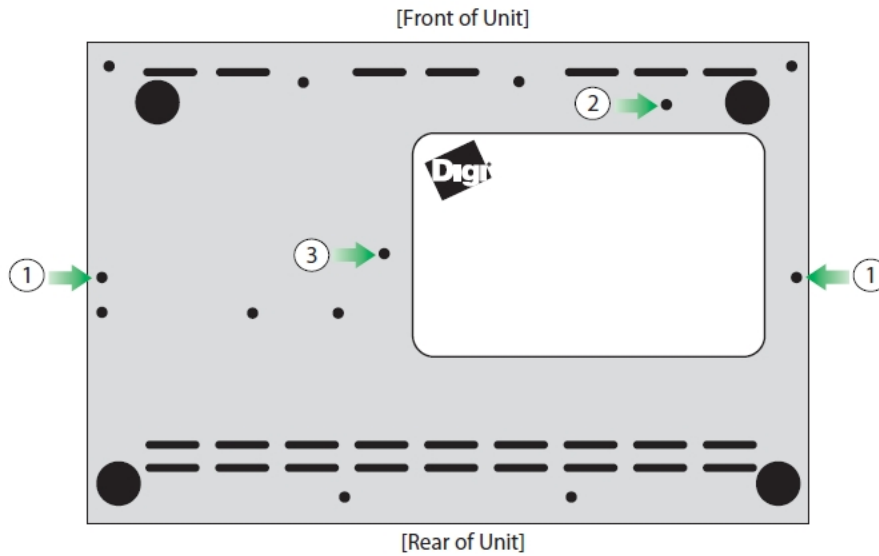

TransPort WR44 R

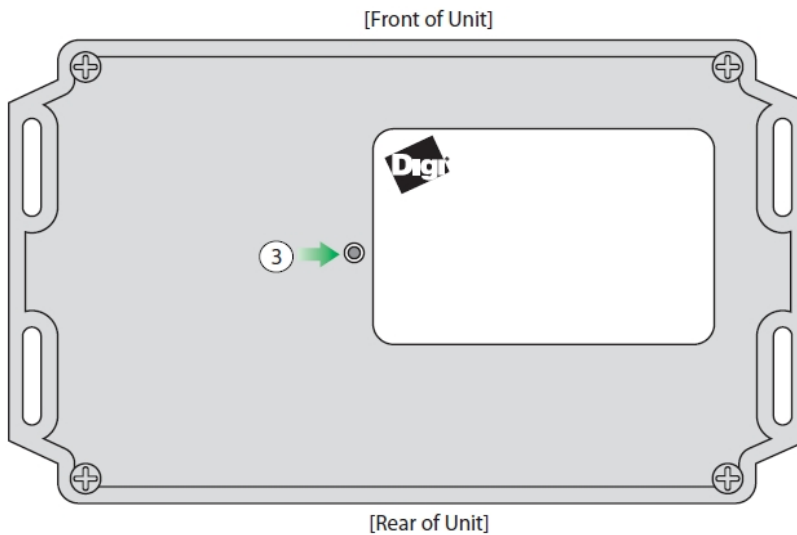

1. Mounting holes.
2. SIM slot cover plate mounting hole.
3. **Reset button:** The reset button is on the underside of the unit. It performs a factory reset. It is recessed to avoid an accidental reset. See [Reset the router to factory defaults](#).

Enclosure features

TransPort WR44



- 1. Commercial enclosure
- 2. Mounting feet

TransPort WR44 R



- 1. Rugged enclosure
- 2. Mounting tabs

TransPort WR44 additional hardware features

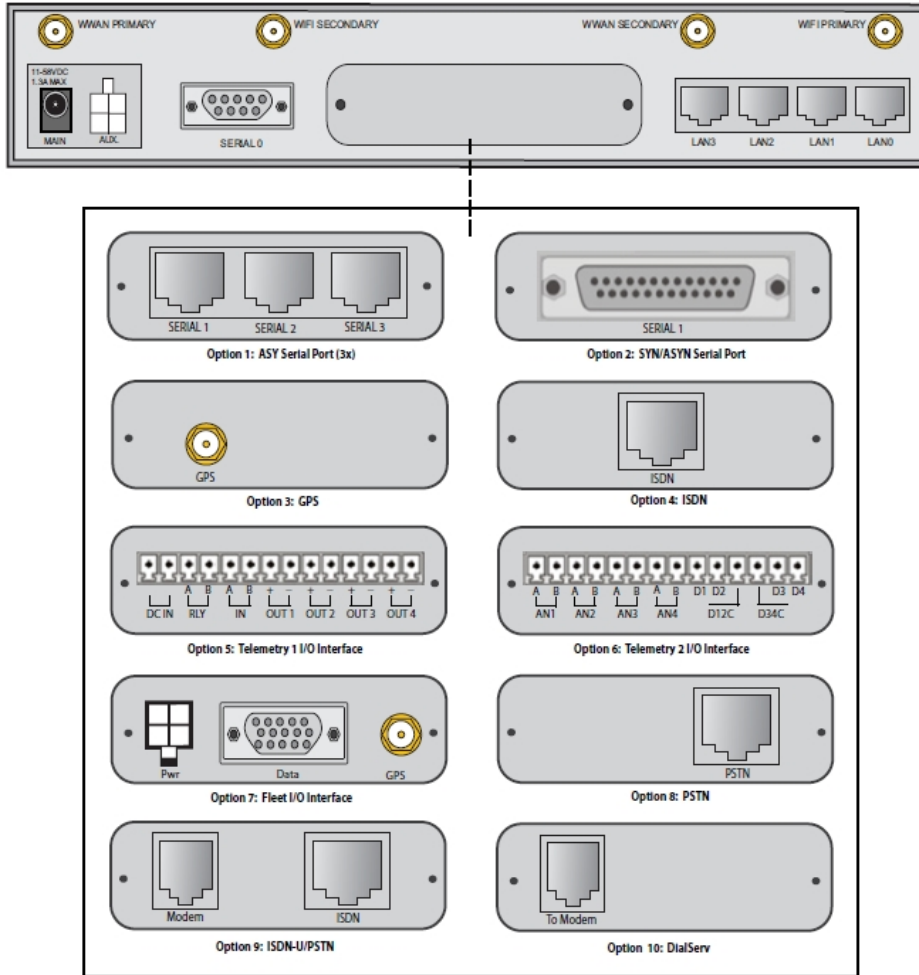

1. **ASY serial port (3x):** Provides three additional asynchronous RS232 serial ports using RJ45 connectors.
2. **SYN/ASYN serial port:** Provides an X.21/RS422/RS232 synchronous / asynchronous serial port using a DB25 connector.
3. **GPS antenna connector (GPS models only):** Provides GPS capabilities using an SMA male connector.
4. **ISDN:** Provides an ISDN Basic Rate Interface (BRI) via an RJ45 port. This can be configured either as a TE (terminal endpoint) or as NT-1 (network termination). The option also includes an additional asynchronous serial port via a second RJ45 port.
5. **Telemetry 1 I/O interface:** Provides 4 opto-isolated digital input ports and 1 opto-isolated digital output port. It also provides a relay I/O port, a voltage monitoring port, and internal temperature monitoring.
6. **Telemetry 2 I/O interface:** Provides 4 isolated analog I/O ports and 4 non-isolated digital I/O ports.

7. **Fleet I/O interface:** Provides CAN and J1708 interface, GPS, 4 non-isolated digital I/O ports, ignition sense port, and a 3 axis accelerometer.
8. **PSTN:** Provides a PSTN interface via an RJ45 connector for dialing out and receiving calls.
9. **ISDN-U/PSTN:** Provides an ISDN-U interface suitable for the USA plus PSTN interface. It can be configured for Bell-103 modulation in leased line mode as well as a normal PSTN interface.
10. **DialServ:** This RJ11/FXS connection converts a PSTN analog modem to a RS-232 serial signal.

For more information on the Telemetry 1, Telemetry 2, and the Fleet I/O Interfaces please see the product specific user's guides, available on www.digi.com on the TransPort WR44 product **Resources** page.

Powering the TransPort WR44 R

Vehicle installation

The TransPort WR44 R shall be powered from a 5A fused circuit or shall be installed with an in-line Slow Blow fuse rated at 5A. Maximum ambient operating temperature is limited to 70 C.

Note Always follow the vehicle manufacturer recommendations for electrical accessories connections. Vehicle installations are considered Service persons only and Restricted Access. All components used in the electrical connection to the vehicle should be UL listed.

Alternate installations

The TransPort WR44 R shall be powered by a certified ITE LPS power supply (9-36 VDC, 18W minimum). Supplies shall be suitable for the ambient for which they are installed. Maximum ambient operating temperature is limited to the lower of the maximum ambient operating temperature of the power supply or 70° C.

Digi recommends the power supplies in the following accessory kits:

- Installations 0° C to +40° C: Digi part number 76000823
- Installations -40° C to +70° C: Digi part number 76000816 (US), 76000904 (EU)

TransPort WR44 hardware specifications

For TransPort WR44 hardware specifications, see [Digi TransPort WR44 specifications](#).

TransPort WR44 R hardware specifications

For TransPort WR44 R hardware specifications, see [Digi TransPort WR44 R specifications](#).



TransPort WR44 accessories

A variety of accessories are available for TransPort products. For the current list of accessories and their Digi part numbers, go to the [TransPort WR44 Part Numbers and Accessories page](#).

TransPort WR44 R accessories

A variety of accessories are available for TransPort products. For the current list of accessories and their Digi part numbers, go to the [TransPort WR44 R Part Numbers and Accessories page](#).

TransPort WR44 / WR44 R RS232 serial pinout

Description	RS232 signal	Direction			
			DB 25 Pin#	DB 9 Pin#	RJ45 Pin #
Transmit Data	TxD	in	2	3	6
Receive Data	RxD	out	3	2	3
Ready To Send	RTS	in	4	7	1
Clear To Send	CTS	out	5	8	8
Data Set Ready	DSR	out	6	6	n/a
Ground	GND	n/a	7	5	5
Data Carrier Detect	DCD	out	8	1	7
Transmitter Clock	TxC	out	15	n/a	n/a
Receiver Clock	RxC	out	17	n/a	n/a
Data Terminal Ready	DTR	in	20	4	2
Ring Indicate	RI	out	22	9	n/a
External Transmitter Clock	ETC	in	24	n/a	n/a

Regulatory and safety statements

RF exposure statement

In order to comply with RF exposure limits established in the ANSI C95.1 standards, the distance between the antenna or antennas and the user should not be less than **20** cm.

FCC Part 15 Class B

Radio Frequency Interference (RFI) (FCC 15.105)

This device has been tested and found to comply with the limits for Class B digital devices pursuant to Part 15 Subpart B, of the FCC rules. These limits are designed to provide reasonable protection against harmful interference in a residential environment. This equipment generates, uses, and can radiate radio frequency energy, and if not installed and used in accordance with the instruction manual, may cause harmful interference to radio communications. However, there is no guarantee that interference will not occur in a particular installation. If this equipment does cause harmful interference to radio or television reception, which can be determined by turning the equipment off and on, the user is encouraged to try and correct the interference by one or more of the following measures:

Reorient or relocate the receiving antenna. Increase the separation between the equipment and receiver. Connect the equipment into an outlet on a circuit different from that to which the receiver is connected. Consult the dealer or an experienced radio/TV technician for help.

Labeling Requirements (FCC 15.19)

This device complies with Part 15 of FCC rules. Operation is subject to the following two conditions: (1) this device may not cause harmful interference, and (2) this device must accept any interference received, including interference that may cause undesired operation.

If the FCC ID is not visible when installed inside another device, then the outside of the device into which the module is installed must also display a label referring to the enclosed module FCC ID.

Modifications (FCC 15.21)

Changes or modifications to this equipment not expressly approved by Digi may void the user's authority to operate this equipment.

TransPort WR44 Declaration of Conformity

Digi has issued Declarations of Conformity for the Digi TransPort WR44 concerning emissions, EMC, and safety. For more information, see [Digi government agency certifications page](#).

Important note

Digi customers assume full responsibility for learning and meeting the required guidelines for each country in their distribution market. Refer to the radio regulatory agency in the desired countries of operation for more information.

CE mark (Europe)

The Digi TransPort WR44 is certified for use in several European countries. For information, visit [Digi government agency certifications page](#).

If the Digi TransPort WR44 is incorporated into a product, the manufacturer must ensure compliance of the final product with articles 3.1a and 3.1b of the RE Directive (Radio Equipment Directive). A

Declaration of Conformity must be issued for each of these standards and kept on file as described in the RE Directive (Radio Equipment Directive).

Furthermore, the manufacturer must maintain a copy of the Digi TransPort WR44 user manual documentation and ensure the final product does not exceed the specified power ratings, antenna specifications, and/or installation requirements as specified in the user manual. If any of these specifications are exceeded in the final product, a submission must be made to a notified body for compliance testing to all required standards.

OEM labeling requirements

The “CE” marking must be affixed to a visible location on the OEM product.

CE labeling requirements

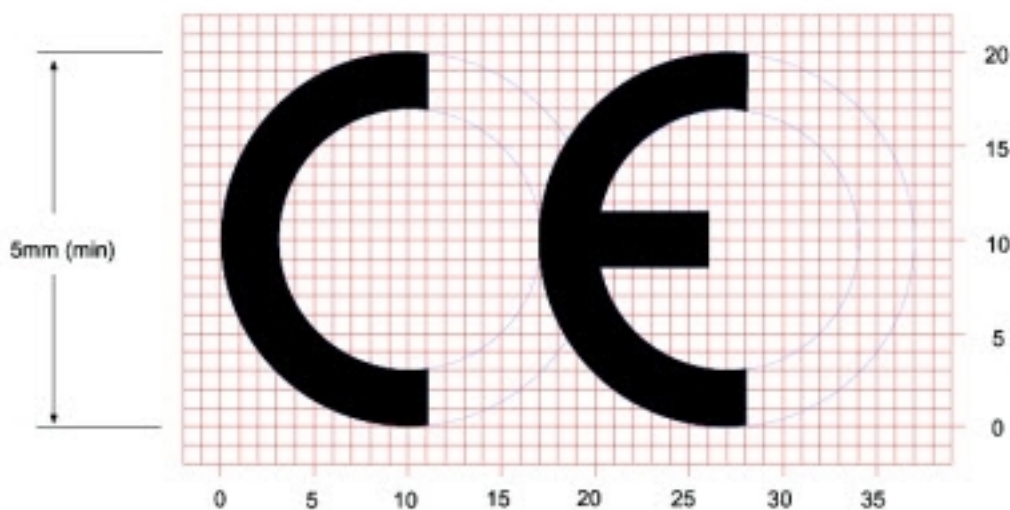

The CE mark shall consist of the initials “CE” taking the following form:

- If the CE marking is reduced or enlarged, the proportions given in the above graduated drawing must be respected.
- The CE marking must have a height of at least 5 mm except where this is not possible on account of the nature of the apparatus.
- The CE marking must be affixed visibly, legibly, and indelibly.

Maximum power and frequency bands

Max power	Frequencies
2 W	Cellular 850 and 900 MHz bands
1 W	Cellular 1800 and 1900 MHz bands
200 mW	13 overlapping channels, each 22 or 40 MHz wide and spaced at 5 MHz. Centered at 2.412 to 2.472 MHz.
251.19 mW	165 overlapping channels, each 22 or 40 or 80 MHz wide and spaced at 5 MHz. Centered at 5180 to 5825 MHz.

Innovation, Science, and Economic Development Canada (IC) certifications

This digital apparatus does not exceed the Class B limits for radio noise emissions from digital apparatus set out in the Radio Interference Regulations of the Canadian Department of Communications.

Le present appareil numerique n'emet pas de bruits radioelectriques depassant les limites applicables aux appareils numeriques de la class B prescrites dans le Reglement sur le brouillage radioelectrique edicte par le ministere des Communications du Canada.

Safety notices

1. Please read all instructions before installing and powering the router. You should keep these instructions in a safe place for future reference.
2. If the power supply shows signs of damage or malfunction, stop using it immediately, turn off the power and disconnect the power supply before contacting your supplier for a repair or replacement.
3. Changes or modifications not expressly approved by the party responsible for compliance could void the user's authority to operate the equipment. Use only the accessories, attachments, and power supplies provided by the manufacturer-connecting non-approved antennas or power supplies may damage the router, cause interference or create an electric shock hazard, and will void the warranty.
4. Do not attempt to repair the product. The router contains no electronic components that can be serviced or replaced by the user. Any attempt to service or repair the router by the user will void the product warranty.
5. TransPort WR44 devices except for the WR44 R are designed for indoor use. Use them in an environment suitable for computers and other electronic equipment.
6. Ports that are capable of connecting to other apparatus are defined as SELV ports. To ensure conformity with IEC60950 ensure that these ports are only connected to ports of the same type on other apparatus.

Special notes on safety for wireless routers

Digi International products are designed to the highest standards of safety and international standards compliance for the markets in which they are sold. However, cellular-based products contain radio devices which require specific consideration. Please take the time to read and understand the following guidance. Digi International assumes no liability for an end user's failure to comply with these precautions.



Wireless routers incorporate a wireless radio module. Users should ensure that the antenna(s) is (are) positioned at least 1 meter away from themselves and other persons in normal operation.

When in a hospital or other health care facility, observe the restrictions on the use of mobile phones. Do not use the router in areas where guidelines posted in sensitive areas instruct users to switch off mobile phones. Medical equipment may be sensitive to RF energy.

The operation of cardiac pacemakers, other implanted medical equipment and hearing aids can be affected by interference from cellular terminals such as the wireless routers when placed close to the device. If in doubt about potential danger, contact the physician or the manufacturer of the device to verify that the equipment is properly shielded. Pacemaker patients are advised to keep the wireless router away from the pacemaker while it is on.



Wireless routers must NOT be operated on aircraft. The operation of wireless appliances in an aircraft is forbidden to prevent interference with communications systems. Failure to observe these instructions may lead to the suspension or denial of cellular services to the offender, legal action, or both.



As with any electrical equipment, do not operate the router in the presence of flammable gases, fumes or potentially explosive atmospheres. Do not use radio devices anywhere that blasting operations occur.



Wireless routers receive and transmit radio frequency energy when power is on. Interference can occur when using the router close to TV sets, radios, computers or inadequately shielded equipment. Follow any special regulations and always power off your router wherever forbidden or when it may cause interference or danger.



SOS IMPORTANT! Wireless routers operate using radio signals and cellular networks cannot be guaranteed to connect in all possible conditions. Therefore, never rely solely upon any wireless device for life critical communications.



WARNING! For environments where the temperature is **55° C** or above, this device must be installed in a restricted access area.

Product Disposal Instructions



The WEEE (Waste Electrical and Electronic Equipment: 2002/96/EC) directive has been introduced to ensure that electrical/ electronic products are recycled using the best available recovery techniques to minimize the impact on the environment. This product contains high quality materials and components which can be recycled. At the end of its life this product **MUST NOT** be mixed with other commercial waste for disposal. Check with the terms and conditions of your supplier for disposal information. Digi International Ltd WEEE Registration number: **WEE/HF1515VU**

TransPort WR44 RR hardware features

Front panel



1. **POWER LED:**
 - **Off:** No power
 - **Green:** TransPort device is powered
2. **LAN (0, 1, 2, 3) LED:** Illuminates steadily when there is a network connection to the LAN port and flashes when data is transmitted or received.
3. **Wi-Fi LED:**
 - **Wi-Fi models only:** Illuminates steady if Wi-Fi activity is present.
4. **SERIAL LED:** Illuminates steadily if a terminal is connected to the **SERIAL** port and the DTR signal is on.
5. **LINK LED:** Illuminates steadily when a wireless WAN data connection has been established.
6. **SIM LED:** Illuminates steadily when a valid SIM card is installed.
7. **ACT LED:** Flashes to indicate that data is being transferred over the wireless WAN network.
8. **SIGNAL LEDs:** Indicate strength of cellular signal.
 - **3 LEDs:** Excellent
 - **2 LEDs:** Good
 - **1 LED:** Fair
 - **0 LEDs:** Poor or No signal
9. **SIM / R-UIM sockets (SIM card models only):** SIM 1 and SIM 2 are for use with the SIMs or R-UIMs (Removable User Identification Modules).

Rear panel

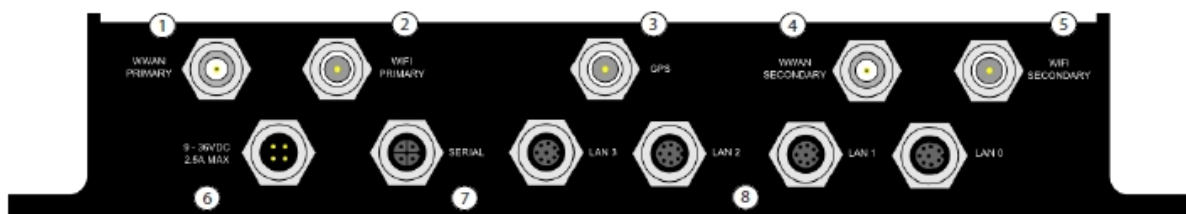

1. **Primary cellular (WWAN) antenna connector:** A TNC female connector that connects the router's primary cellular antenna.
2. **Primary Wi-Fi (WLAN) antenna connector (Wi-Fi models only):** A TNC male connector that connects the router's secondary Wi-Fi antenna.
3. **GPS antenna connector (GPS models only):** A TNC male connector that connects the router's GPS antenna.
4. **Secondary cellular (WWAN) antenna connector:** A TNC female connector that connects the router's secondary cellular antenna. It is highly recommended to use the secondary antenna for diversity. In most circumstances, dual antennas will provide improved signal strength thus better performance.
5. **Secondary Wi-Fi (WLAN) antenna connector (Wi-Fi models only):** A TNC male connector that connects the router's secondary Wi-Fi antenna.
6. **9-36VDC socket:** An M12 socket that connects the router to an alternative 9-36VDC power supply (not supplied) using the supplied fused power cable. This cable also contains two programmable GPIO signal lines.
7. **Serial port:** This M12 port provides an asynchronous RS232 serial port for connecting the router to a compatible serial device. This is a DCE serial port and allows CLI access to the device by default; the baud rate is 115200.
8. **LAN ports:** These M12 ports connect the router to a 10/100 base-T LAN. These ports are auto-sensing for speed and wiring (straight-through or cross-over).

Enclosure features



1. Rugged Enclosure
2. Mounting Tabs

TransPort WR44 RR hardware specifications

For TransPort WR44 hardware specifications, see [Digi TransPort WR44 RR specifications](#)

TransPort WR44 RR accessories

A variety of accessories are available for TransPort products. For the current list of accessories and their Digi part numbers, go to the [TransPort WR44 RR Part Numbers and Accessories page](#).

TransPort WR44 RR Ethernet cable connectors and pinouts

Pin locations

4-pin connector pin locations

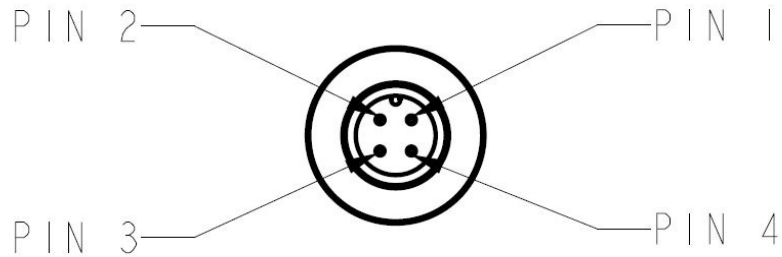

8-pin connector pin locations

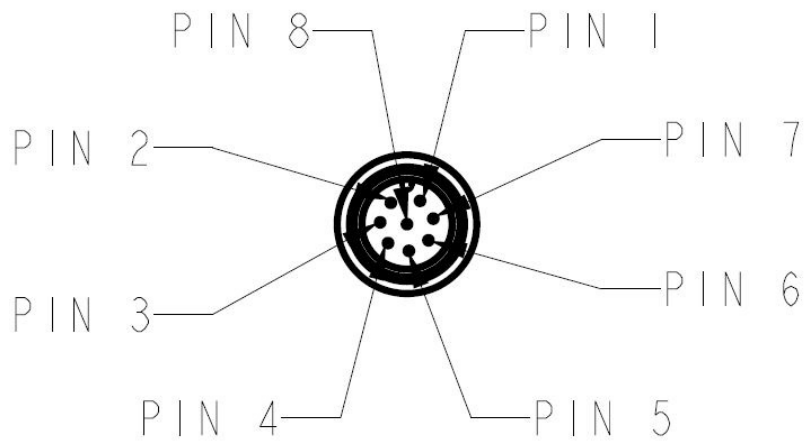

Power connector

The power connector is an M12-4 pin, A Coded connector. Pinout is as follows:

Pin	Signal
1	Power +ve
2	GPIO 0
3	Power -ve
3	GPIO 1

Serial connector

The serial connector is an M12-5 pin, A Coded connector. Pinout is as follows:

Pin	DB-9 (DCE)
1	2 (RXD)
2	3 (TXD)
3	8 (CTS)
4	7 (RTS)
5	5 (GTM)

Ethernet connectors

Ethernet connector M12-4 pin, D coded

M12 Pin	RJ45	Signal	Notes
1	1	TX+	Twisted pair
3	2	TX-	
2	3	RX+	Twisted pair
4	6	RX-	

Ethernet connector M12-4 pin, D coded

M12 Pin	RJ45	Signal	Notes
4	6	RX-	Twisted pair
6	3	RX+	
5	1	TX+	Twisted pair
8	2	TX-	
1	N/C		
2	N/C		
3	N/C		
7	N/C		

Regulatory and safety statements

RF exposure statement

In order to comply with RF exposure limits established in the ANSI C95.1 standards, the distance between the antenna or antennas and the user should not be less than **20** cm.

FCC Part 15 Class B

Radio Frequency Interference (RFI) (FCC 15.105)

This device has been tested and found to comply with the limits for Class B digital devices pursuant to Part 15 Subpart B, of the FCC rules. These limits are designed to provide reasonable protection against harmful interference in a residential environment. This equipment generates, uses, and can radiate radio frequency energy, and if not installed and used in accordance with the instruction manual, may cause harmful interference to radio communications. However, there is no guarantee that interference will not occur in a particular installation. If this equipment does cause harmful interference to radio or television reception, which can be determined by turning the equipment off and on, the user is encouraged to try and correct the interference by one or more of the following measures:

Reorient or relocate the receiving antenna. Increase the separation between the equipment and receiver. Connect the equipment into an outlet on a circuit different from that to which the receiver is connected. Consult the dealer or an experienced radio/TV technician for help.

Labeling Requirements (FCC 15.19)

This device complies with Part 15 of FCC rules. Operation is subject to the following two conditions: (1) this device may not cause harmful interference, and (2) this device must accept any interference received, including interference that may cause undesired operation.

If the FCC ID is not visible when installed inside another device, then the outside of the device into which the module is installed must also display a label referring to the enclosed module FCC ID.

Modifications (FCC 15.21)

Changes or modifications to this equipment not expressly approved by Digi may void the user's authority to operate this equipment.

TransPort WR44 RR Declaration of Conformity

Digi has issued Declarations of Conformity for the Digi TransPort WR44 RR concerning emissions, EMC, and safety. For more information, see [Digi's government agency certifications page](#).

Important note

Digi customers assume full responsibility for learning and meeting the required guidelines for each country in their distribution market. Refer to the radio regulatory agency in the desired countries of operation for more information.

CE mark (Europe)

The Digi TransPort WR44 RR is certified for use in several European countries. For information, visit [Digi's government agency certifications page](#).

If the Digi TransPort WR44 RR is incorporated into a product, the manufacturer must ensure compliance of the final product with articles 3.1a and 3.1b of the RE Directive (Radio Equipment

Directive). A Declaration of Conformity must be issued for each of these standards and kept on file as described in the RE Directive (Radio Equipment Directive).

Furthermore, the manufacturer must maintain a copy of the Digi TransPort WR44 RR user manual documentation and ensure the final product does not exceed the specified power ratings, antenna specifications, and/or installation requirements as specified in the user manual. If any of these specifications are exceeded in the final product, a submission must be made to a notified body for compliance testing to all required standards.

OEM labeling requirements

The “CE” marking must be affixed to a visible location on the OEM product.

CE labeling requirements

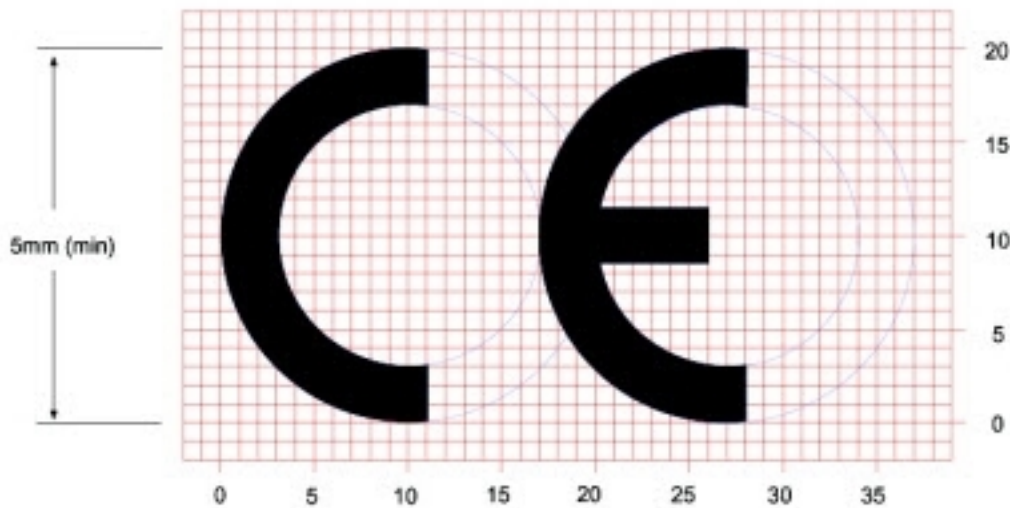

The CE mark shall consist of the initials “CE” taking the following form:

- If the CE marking is reduced or enlarged, the proportions given in the above graduated drawing must be respected.
- The CE marking must have a height of at least 5 mm except where this is not possible on account of the nature of the apparatus.
- The CE marking must be affixed visibly, legibly, and indelibly.

Maximum power and frequency bands

Max power	Frequencies
2 W	Cellular 850 and 900 MHz bands
1 W	Cellular 1800 and 1900 MHz bands
200 mW	13 overlapping channels each 22 or 40 MHz wide and spaced at 5 MHz. Centered at 2.412 to 2.472 MHz
251.19 mW	165 overlapping channels, each 22 or 40 or 80 MHz wide and spaced at 5 MHz. Centered at 5180 to 5825 MHz.

Innovation, Science, and Economic Development Canada (IC) certifications

This digital apparatus does not exceed the Class B limits for radio noise emissions from digital apparatus set out in the Radio Interference Regulations of the Canadian Department of Communications.

Le present appareil numerique n'emet pas de bruits radioelectriques depassant les limites applicables aux appareils numeriques de la class B prescrites dans le Reglement sur le brouillage radioelectrique edicte par le ministere des Communications du Canada.

Safety notices

1. Please read all instructions before installing and powering the router. You should keep these instructions in a safe place for future reference.
2. If the power supply shows signs of damage or malfunction, stop using it immediately, turn off the power and disconnect the power supply before contacting your supplier for a repair or replacement.
3. Changes or modifications not expressly approved by the party responsible for compliance could void the user's authority to operate the equipment. Use only the accessories, attachments, and power supplies provided by the manufacturer-connecting non-approved antennas or power supplies may damage the router, cause interference or create an electric shock hazard, and will void the warranty.
4. Do not attempt to repair the product. The router contains no electronic components that can be serviced or replaced by the user. Any attempt to service or repair the router by the user will void the product warranty.
5. The TransPort WR44 RR is designed for indoor use. Use it in an environment suitable for computers and other electronic equipment.
6. Ports that are capable of connecting to other apparatus are defined as SELV ports. To ensure conformity with IEC60950 ensure that these ports are only connected to ports of the same type on other apparatus.

Special notes on safety for wireless routers

Digi International products are designed to the highest standards of safety and international standards compliance for the markets in which they are sold. However, cellular-based products contain radio devices which require specific consideration. Please take the time to read and understand the following guidance. Digi International assumes no liability for an end user's failure to comply with these precautions.



Wireless routers incorporate a wireless radio module. Users should ensure that the antenna(s) is (are) positioned at least 1 meter away from themselves and other persons in normal operation.

When in a hospital or other health care facility, observe the restrictions on the use of mobile phones. Do not use the router in areas where guidelines posted in sensitive areas instruct users to switch off mobile phones. Medical equipment may be sensitive to RF energy.

The operation of cardiac pacemakers, other implanted medical equipment and hearing aids can be affected by interference from cellular terminals such as the wireless routers when placed close to the device. If in doubt about potential danger, contact the physician or the manufacturer of the device to verify that the equipment is properly shielded. Pacemaker patients are advised to keep the wireless router away from the pacemaker while it is on.



Wireless routers must NOT be operated on aircraft. The operation of wireless appliances in an aircraft is forbidden to prevent interference with communications systems. Failure to observe these instructions may lead to the suspension or denial of cellular services to the offender, legal action, or both.



As with any electrical equipment, do not operate the router in the presence of flammable gases, fumes or potentially explosive atmospheres. Do not use radio devices anywhere that blasting operations occur.



Wireless routers receive and transmit radio frequency energy when power is on. Interference can occur when using the router close to TV sets, radios, computers or inadequately shielded equipment. Follow any special regulations and always power off your router wherever forbidden or when it may cause interference or danger.



SOS IMPORTANT! Wireless routers operate using radio signals and cellular networks cannot be guaranteed to connect in all possible conditions. Therefore, never rely solely upon any wireless device for life critical communications.



WARNING! For environments where the temperature is **55° C** or above, this device must be installed in a restricted access area.

Product Disposal Instructions



The WEEE (Waste Electrical and Electronic Equipment: 2002/96/EC) directive has been introduced to ensure that electrical/ electronic products are recycled using the best available recovery techniques to minimize the impact on the environment.

This product contains high quality materials and components which can be recycled. At the end of its life this product **MUST NOT** be mixed with other commercial waste for disposal. Check with the terms and conditions of your supplier for disposal information. Digi International Ltd WEEE Registration number: **WEE/HF1515VU**

Purchase additional serial cables

For TransPort models that include serial ports with RJ45 connectors, Digi offers the following serial cables for connectivity:

Digi part number	Description
76000855	RJ45 to DB9 Female 6'
76000856	RJ45 to DB25 Male 6'
76000857	RJ45 to DB25 Female 6'

Signal strength indicators

On routers equipped with W-WAN modules, there are three LEDs on the front panel that indicate signal strength.

Antenna specifications for Wi-Fi 2.4 GHz modules

The Wi-Fi 2.4 GHz modules for this product obtained its complete certification by using the antenna described here. End users in North America should use an antenna that matches these specifications to maintain the module's certification. You can use antennas of the same type but operating with a lower gain.

Attribute	Property
Frequency Range	2.4 to 2.5 GHz
Impedance	50 Ohm
VSWR	1.92 max
Return Loss	-10 dB max
Gain	1.8 dBi
Polarization	Linear
Radiation Pattern	Near omnidirectional in the horizontal plane
Admitted Power	1 W
Electrical	$1/2 \lambda$ Dipole

Using the web interface

The first time you power on a TransPort device, the **Getting Started Wizard** steps you through the process of initial configuration. After the wizard completes, the next time you access the device, a login prompt appears. See [Log in to the device](#) for login instructions.

After you log in, the TransPort **Dashboard** appears. The **Dashboard** provides a snapshot of current activity for the device.

In this help system, task topics show how to perform tasks:

Web

Shows how to perform a task using the web interface.

Command line

Shows how to perform a task using the command line interface.

Log in to the device	108
Log out and return to the login page	110
Execute a command from the web interface	111
Signal strength indicators on the Mobile status page	112
Use the web interface wizards	113

Log in to the device

By default, Digi Transport routers have a static IP address of **192.168.1.1** with DHCP server **enabled**. To access the router using a web browser:

1. If the Digi TransPort router is not already connected to a LAN, connect an Ethernet cable between the LAN port on the Digi Transport and your PC.

Note All TransPort WR models are **auto-sensing** for **10/100** operation. Most models are also **auto MDI/MDX**, such as will automatically work with either a straight-through or cross-over cable.

2. Open a web browser. Enter the router's Ethernet IP address (**192.168.1.1**) into your web browser after configuring your PC to have an address on the same subnet. A login page appears.
3. Enter the default username and password.

- User name: **admin**
- Password: The default password is printed on the device label.

Note If a device with the default password printed on the label is downgraded to a firmware release prior to release 8.x, the default password will be **default**.

- If the password is not on the label, then the default user name is **username**, and the default password is **password**.
- If neither user name/password combination works, the password may have been updated. Contact your system administrator.

Note You should change the default username and password for all users. See [Configure user security settings](#).

4. Click the **Log In** button and enter the default password, password and click **Log In** button. The password appears as a series of dots for security purposes.

TRANSPORT WR44V2 (SN: 308301) CONFIGURATION AND MANAGEMENT

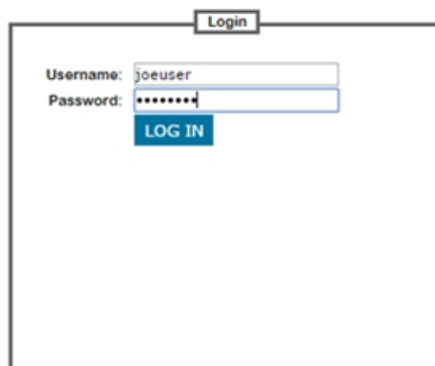

After entering the username and password, the **Home** page is displayed. This page is the main operations page for the router. The main menu is on the left side of the Home

page. Clicking menu items displays the settings or operations for that item.

The screenshot displays the web interface of a Digi TransPort router. On the left is a navigation menu with categories like Home, Wizards, Configuration, Network, Alarms, System, Remote Management, Security, Telemetry, Applications, Basic, Python, Management, Network Status, Connections, Telemetry, Event Log, Analyser, Top Talkers, Administration, System Information, File Management, X.509 Certificate Management, Backup/Restore, Update Firmware, Factory Default Settings, Execute a command, Save configuration, Reboot, and Logout. The main content area is titled 'Home' and contains six panels, each with a dropdown menu and a 'more' link at the bottom:

- System**: Model: TransPort WR44v2, Part Number: WR44-U800-CE1-SU, Serial Number: 308301, FW Version: 5.2.18.3 (May 23 2017 09:40:45), Image Number: 0, Boot Version: 7.61u, Uptime: 4 hours 6 minutes 56 seconds, System Time: 31 May 2017 0:29:27, CPU Utilization: 2% (Min: 1%, Max: 99%, Avg: 1%), Temperature: 33°C (Internal), Description, Contact, Location.
- LEDs**: Power, Ethernet 0, Ethernet 1, Ethernet 2, Ethernet 3, Wi-Fi, Serial, Link, SIM, Activity, Signal 1, Signal 2, Signal 3.
- Device Cloud**: Server: my.devicecloud.com, Status: Disabled, Device ID: 00000000-00000000-00042DFF-FF04B44D, Uptime: 0 seconds, Data Received: 0 Bytes, Data Sent: 0 Bytes.
- Interfaces**: Ethernet 0, Ethernet 1, Ethernet 2, Ethernet 3, Wi-Fi Node 0, Wi-Fi Node 1, Wi-Fi Node 2, Wi-Fi Node 3, Cellular.
- Cellular**: Module: LE910-SVG, SIM: Detected (using SIM 1), Signal Strength: Fair (-106 dBm), Signal Quality: Excellent (-8 dB), Uptime: 25 Minutes 21 Seconds, Temperature: 37°C, IP address: 100.80.115.84, DNS Server: 198.224.149.135, Data Received: 6.06 KB, Data Sent: 8.09 KB.
- Ethernet 0**: Description, IP Address: 10.10.14.21 (DHCP), Mask: 255.255.255.0, MAC: 00:04:2D:04:B4:4D, Speed: 100, Mode: Full Duplex, Data Received: 864.17 MB, Data Sent: 237.77 MB.

Log out and return to the login page

Web

To log out the current user and return to the web interface login page, select **Logout**.

Execute a command from the web interface

Web

1. To enter TransPort CLI commands from the web interface, go to **Administration > Execute a Command**.

A majority of the commands mentioned in this User Guide can be entered using this feature.

2. Enter the command name and click **Execute**.

The command output displays, for example:

Administration - Execute a command

Command:

Command: uptime
Command result

Uptime 3 Hrs 34 Mins 45 Seconds
OK

Signal strength indicators on the Mobile status page

On routers equipped with W-WAN modules, there are three LEDs on the front panel that indicate the strength of the signal, as shown in the following table.

Web

To display signal strength, go to **Management > Network Status > Mobile**:

[Management - Network Status > Interfaces > Mobile](#)

▼ **Interfaces**

- ▶ Ethernet
- ▶ Wi-Fi
- ▼ **Mobile**

The following information and statistics can be used to manage and monitor your mobile connection. This information may also be helpful in troubleshooting problems with the mobile network.

Mobile Connection

Registration Status: 1 (registered) tac:BE43 ci:02E90520
 Signal Strength: Fair (-106 dBm)
 Signal Quality: Excellent (-7 dB)
 Connection type: NDIS

The signal strength is shown in negative dB. Therefore, the stronger the signal, the smaller the number. As a guide, **-51 dBm** is a very strong signal, normally only obtained very close to a cell site. **-115 dBm** represents no signal. If your router reports **-115dBm**, reorient the antenna or add an external antenna.

The following values are specific to LTE. At 2G/3G technology, any strength lower than **-100 dBm** becomes unusable.

LEDs lit	Signal Strength
None	No Signal: under -113 dBm
1	Weak signal: -112 dBm to -87 dBm
2	Good signal: -86 dBm to -71 dBm
3	Excellent signal: -70 dBm to -51 dBm

Use the web interface wizards

Web

The Wizards page contains wizards that simplify common configuration tasks. These wizards set the minimum number of parameters to complete the required configuration task. Because these wizards configure a generic group of settings, using them to configure features may not be suitable for specific configuration scenarios.

Wizards

Select the wizard you wish to run

- Quick Start Wizard
- Serial interface wizard
- Create an aggressive mode LAN to LAN IPsec tunnel
- SureLink wizard
- GOBI module carrier wizard
- Dual SIM wizard

Use the Quick Start wizard

From the Wizards page, select **Quick Start wizard** to display and configure the options required for basic configuration of the **Eth 0**, **WLAN**, and **WWAN** interfaces. From this wizard page, you can configure Ethernet LAN interface.

Select **Obtain an IP address automatically** if your network supports this capability. Otherwise, assign the IP settings appropriate for your network.

Obtain an IP address automatically

Use the following IP address:

IP Address:

Subnet mask:

Default gateway:

Obtain a DNS server address automatically

Use the following DNS server addresses:

Preferred DNS Server:

Alternate DNS Server:

Use the Serial Interface wizard

Web

Use the **Serial interface wizard** to select a serial port and profile for your application.

Serial interface wizard

This wizard allows you to select a serial port and profile for your application.

Serial Port Configuration			
Port	Description	Profile	Serial Configuration
Port 0		None	115200 8N1
Port 1		None	115200 8N1
Port 2		modemcc(info) 0	115200 8N1
Port 3		None	115200 8N1
Port 4		modemcc 0	115200 8N1
Port 5		None	115200 8N1
Port 6		None	Auto 8N1
Port 7		None	Auto 8N1
Port 8		None	Auto 8N1

Edit Port profile for

Next

Cancel

Use the Create an aggressive mode LAN to LAN IPsec tunnel wizard

Use the **Create an aggressive mode LAN to LAN IPsec tunnel wizard** to configure an aggressive mode LAN to LAN IPsec tunnel to a remote host. The tunnel is configured as an initiator, which means the IPsec tunnel is responsible for starting the VPN connection.

Create an aggressive mode LAN to LAN IPsec tunnel

Provide a descriptive name for the tunnel.

Tunnel description:

Enter the WAN IP address of the other VPN router or concentrator.

Destination address:

Use the SureLink wizard

Use the **SureLink wizard** to configure the Digi TransPort router to stay connected to the W-WAN (Wireless Wide Area Network) under adverse conditions. The Digi TransPort router has several features designed to recover from network issues and other problems.

Automatic power cycling of the internal Wireless WAN radio occurs if the PPP link to the network cannot be established. If a problem occurs when the PPP link is already established, some mechanism must be employed to detect the dead link and deactivate it. There are two types of dead link detection techniques: passive and active. Before selecting your preferred technique, read the following explanation carefully, because it is important that you make the correct selection for your circumstances.

SureLink wizard

Please choose your preferred technique then click next.

Passive

Active

Passive link detection techniques

Passive techniques work by monitoring data that is regularly sent over the W-WAN. Because it is necessary for data to be sent over the W-WAN for a problem to be detected, these techniques are only suitable when the equipment on the router's Local Area Network (LAN) regularly sends data over the W-WAN. The main advantage of passive techniques are:

- No additional data charges (if your mobile operator charges you for data).
- In a hub and spoke deployment, no additional load will be placed on equipment at the hub.

The main disadvantages are:

- If the equipment on the LAN does not regularly send data over the W-WAN and a problem with the connection occurs, it is not possible to connect to the router or the router's LAN remotely until the equipment on the LAN sends data.
- Because the Digi TransPort router requires a certain amount of time to detect and recover from a network problem, if a problem does occur, the equipment on the LAN is subject to delays when it first attempts to send data.

Active link detection techniques

Active techniques work by sending test data to the link. For example, a ping, UDP packet or IPsec keep-alive (Dead Peer Detection) packet may be sent. The main advantage of active techniques are:

- Problems are detected promptly, and the availability of remote access to the router or its LAN is maximized.
- Problems can be repaired before equipment on the router's LAN needs to use the W-WAN, resulting in no delays when sending data.

The main disadvantages are:

- Some mobile operators charge for the data sent to test the link.
- In a hub-and-spoke deployment, additional load will be placed on equipment at the hub end by the test data.

Use the GOBI Module Carrier wizard

For routers with a GOBI module installed, use the **GOBI Module Carrier wizard** to configure the router for a specified WWAN carrier. Use this wizard to select the GOBI module firmware for your WWAN connection. Changes to the router configuration will be made based on the firmware selection. By default, the router is configured to load firmware ID **0** (Generic UMTS).

Please choose the carrier applicable to this unit

- Generic UMTS
- Verizon CDMA
- Sprint CDMA
- IUSACELL CDMA
- AT&T/Cingular UMTS
- T-Mobile USA UMTS
- Docomo UMTS
- Orange UMTS
- Vodafone UMTS
- Telefonica UMTS
- Telecom Italia UMTS
- OMH CDMA/RUIM
- China Telecom

Cancel

Use the Dual SIM wizard

Web

Use the **Dual SIM wizard** to configure your router for dual SIM failover. It will determine the most appropriate configuration for your circumstances by explaining the options and then asking questions. Use this wizard to configure the router to detect a link failure and automatically switch to the second installed SIM. This wizard only helps to configure the most common methods of link error detection.

This wizard is run from a factory default configuration or close to a factory default configuration. If changes have been made to the W-WAN configuration other than username, password and APN, running this wizard could cause unanticipated behavior.

SIM weighting

There are two common dual SIM configurations:

- **Equal weighting:** Use this option when no SIM has preference over the other. In the event of a problem, the router will fail over from one SIM to the other. Once it has failed over, it will remain on the alternate SIM until another problem is detected, when it will fail back to the original SIM. This method keeps down time to a minimum.
- **SIM 1 has priority over SIM 2 or SIM 2 has priority over SIM 1:** Use this option when one SIM has a higher priority than the other. After boot-up, the router uses the primary SIM if possible, and in the event that a problem occurs, the router will fail over to the secondary SIM. The router uses the secondary SIM for a configurable time, or until a problem is detected. When the configured time has elapsed or a problem is detected, the router will attempt to fail back to the primary SIM.

These options are useful if one SIM is preferred over another, for example, if the data charges are cheaper on the primary SIM. Note that the internal radio module must be power cycled during SIM switchover. Therefore, reverting to the primary SIM after the router uses the secondary SIM for the configured length of time will result in an outage. If the router still cannot use the primary SIM, there will be a further delay while the router reverts back to the secondary SIM.

Please make the appropriate selection:

- Equal weighting
- SIM 1 has priority over SIM 2
- SIM 2 has priority over SIM 1

Using the command-line interface

About the Digi TransPort command line interface	122
Supported command types	123
Required software for using the command line	124
Connect to the TransPort router from a PC	125
Log in to the command line interface	126
Exit the command line interface	127
Commands and the active port	128
When commands take effect	129
View current configuration changes	130
Save changes	131
Configure network settings	132
Establish a remote connection	134
Application commands	135
AT commands	155

About the Digi TransPort command line interface

Using a Web browser to modify values in the configuration pages is the simplest way to configure the router. This process is described in the next chapter. However, if you do not have access to a Web browser, the router can be configured using text commands. You can enter these commands directly through one of the serial ports or via a Telnet session. Remote configuration is also possible using Telnet or X.25.

Note Low level permission users are designed to work in the web interface only. Command line use is not supported for these users.

Supported command types

There are several types of text commands:

- **Application commands, also known as text commands:** Application commands are specific to Digi International products and control most features of the router when the Web interface is not being used. For more information about application commands, see [Application commands](#).
- **AT commands and S registers:** Digi TransPort supports AT commands and Special registers (S registers) to maintain compatibility with modems, when using the router as a modem replacement. For more information about the AT commands, see [AT commands](#).
- **X.3 commands:** These are standard X.3 commands for X.25 PAD mode only. See [Configure X.25 parameters](#).
- **TPAD commands:** These are for TPAD mode only. See [Configure TPAD parameters](#).

Required software for using the command line

Using the command line requires the following:

- A PC connected to the Digi TransPort router.
- Terminal emulation/communications software, such as HyperTerminal™ (supplied with Windows) or TeraTerm™.

Connect to the TransPort router from a PC

If you configured the router by using the Getting Started Wizard at setup time, following instructions in the Quick Start Guide for your product, your router is already configured.

Command line

1. Verify that the router is connected to a PC.
2. Verify that terminal emulation software, such as TeraTerm or HyperTerminal, is installed on the PC.
3. Configure your terminal emulation software:
 - COM Port: select the appropriate port, typically **COM1**
 - Baud Rate: **115200**
 - Data Bits: **8**
 - Stop Bits: **1**
 - Parity: **No**
 - Parity: **No Parity**
 - Flow Control: **None**
4. Verify that the connection is active by typing **at** (in upper or lower case) and pressing ENTER. If the device is functioning properly, it will return the response **OK**. To learn more about the AT commands, see [AT commands](#).
5. Verify that the COM port is configured correctly by typing **ati5** and pressing ENTER.

Log in to the command line interface

Command line

When the login prompt displays on the command line, enter the default user name and password:

- User name: **admin**
- Password: The default password is printed on the device label.

Note If a device with the default password printed on the label is downgraded to a firmware release prior to release 8.x, the default password will be **default**.

- If the password is not on the label, then the default user name is **username**, and the default password is **password**.
- If neither user name/password combination works, the password may have been updated. Contact your system administrator.

Note You should change the default username and password for all users. See [Configure user security settings](#).

Exit the command line interface

Command line

To exit the command line interface, type **exit** and press ENTER.

Commands and the active port

In most cases, when entering AT or text commands, the command only affects the settings for the active port. This is usually the port to which you are physically connected, but you may, if necessary, set the active port to another port of your choice using the **AT\PORT=N** command, where **N** is a port number from **0-3**.

When commands take effect

All entered commands take effect immediately.

View current configuration changes

Command line

To view the current configuration settings, type the following command:

```
config c show
```

Save changes

Command line

To save changes made to the router, type the following command:

```
config 0 save
```

Configure network settings

To configure the router with an IP address as part of an existing network, use the following commands.

Command line

Note The DHCP server will still operate unless it is disabled.

1. Set the IP address of **Eth 0**:

```
eth 0 ipaddr xxx.xxx.xxx.xxx
```

2. Set the subnet mask for **Eth 0**:

```
eth 0 mask xxx.xxx.xxx.xxx
```

For example, to assign the IP address **192.168.10.254/24**, enter:

```
eth 0 ipaddr 192.168.10.254
eth 0 mask 255.255.255.0
```

Note When the subnet mask is set to **255.255.255.0**, this value does not display in the output of the **config c show** command because **255.255.255.0** is a default value.

3. To disable the DHCP server, use the **ipmin !** option with the **dhcp** command. This command removes the minimum IP address for DHCP, which in turn disables the DHCP server. The exclamation point (!) character removes a value or sets it back to its default.

```
dhcp 0 ipmin !
```

4. To configure the DHCP server for a different subnet, use the **ipmin** option with the **dhcp** command by setting the minimum IP address to the start of the DHCP pool on the new subnet:

```
dhcp 0 ipmin xxx.xxx.xxx.xxx
```

5. Set the number of IP addresses in the DHCP pool:

```
dhcp 0 iprange <value>
```

where <value> is a number between 1-255, representing the number of addresses that the DHCP server should serve within the DHCP pool.

6. Set the IP gateway address that the DHCP clients should use. Normally, this address is the router's LAN IP address.

```
dhcp 0 gateway xxx.xxx.xxx.xxx
```

7. Set the subnet mask DHCP clients should use:

```
dhcp 0 mask xxx.xxx.xxx.xxx
```

8. Set the DNS server DHCP clients should use:

```
dhcp 0 dns
```

Establish a remote connection

Once you have configured the router, there are several ways to establish a link to a remote system:

- Use the **ATD** command to make an outgoing V.120 call. See [atd: Dial a call](#).
- Initiate a DUN session to establish a dial-up PPP connection.
- Make an outgoing X.25 call using the **ATD** command followed by the X.28 **CALL** command.
- Make an outgoing TPAD (Transaction PAD) call using the TPAD **a** (address) command followed by the appropriate NUA. This is normally only carried out under software control.

Similarly, incoming calls are handled according to the protocols bound to the ASY ports, and whether answering is enabled for each protocol.

Application commands

The Digi TransPort router also supports numerous text-based application commands that are specific to Digi International products, and do not require the AT prefix. Some of these are generic, such as they are related to the general operation of the router; others are application- or protocol-specific.

Application commands are case-insensitive

Digi application commands (referred to as **text commands** or **CLI commands** throughout the remainder of this guide), can be entered in upper or lower case.

One command per line

Unlike AT commands, only one command may be entered on a line. After each successful command, the **OK** result code will be issued. An invalid command will cause the **ERROR** result code to be issued.

Application command syntax

The general syntax for an application commands is:

```
<entity> <instance> <param_name> <value>
```

where:

<entity> is the name of the router feature being configured.

<instance> is the instance number for the entity that you are configuring.

<param_name> is the name of the parameter that you wish to configure.

<value> is the new value for the specified parameter.

For example, to set the window size to 5 for X.25 PAD instance **1**, type:

```
pad 1 window 5
```

If there is only once instance of particular entity, type **0** for the instance number.

Use wildcards in commands

Command line

When viewing and not setting parameters, you can use wildcards in the field **<param_name>**. For example, to view all **PPP 1** parameters that start with **r**, enter:

```
ppp 1 r* ?
```

The output is:

```
ppp 1 r* ?
```

```
r_mru: 1500
```

```
r_acfc: OFF
```

```
r_pfc: OFF
```

```
r_pap: ON
```

```
r_chap: ON
```

```
r_accm: 0xffffffff
```

```
r_comp: OFF
r_addr: OFF
r_callb: 0
rxtimeout: 23
rdoosdly: 0
restdel: 2000
rebootfails: 0
rip: 0
ripip:
ripauth: 1
ripis: OFF
r_md5: 1
r_ms1: 1
r_ms2: 1
rbcast: OFF
OK
```

Use special usernames in commands

You can use several special usernames for local and remote authentication:

Username	Description
%s	Uses the serial number of the router as the username.
%i	Uses the IMEI of the cellular module as the username.
%c	Uses the ICCID of the SIM as the username.

If a % symbol is part of the username, you must enter another % symbol as an escape character. For example, enter **user%1** as **user%%1**.

Using the command-line parameter tables in this guide

Command line

Many sections in this guide include tables showing the command-line interface parameters that relate to the web-based settings. With a few exceptions, these parameters nearly always take the following format:

```
<entity> <instance> <param_name> <value>
```

Where:

<entity>

The name of the router feature being configured.

eth, ppp, modemcc, wifi, ike, eroute, etc.

<instance>

The instance of the feature, such as **0, 1, 2, 3**, etc... Some entities only use **0**. Others have multiple instances.

<parameter>

The parameter name, such as, **ipaddr, mask, gateway**, etc.

<value>

The value to set, such as, **off, on, 192.168.1.1, username, free_text**, etc.

For example, the following table is displayed for Ethernet parameters:

Command	Instance	Parameter	Values	Equivalent web parameters
eth	n	descr	Free text field	Description
eth	n	ipaddr	Valid IP address	IP Address
eth	n	mask	Valid Subnet Mask	Mask
eth	n	gateway	IP address	Gateway
eth	n	dnsserver	IP address	DNS Server
eth	n	secdns	IP address	Secondary DNS Server
eth	n	dhcpcli	Off / On	On =Get an IP address automatically using DHCP Off =Use the following IP address

To use this table, read the row from left to right and replace values as appropriate. The first four columns only are needed for entering commands; the rightmost column shows the equivalent setting in the web interface.

If the **Instance** is **n** in the table, it is because there are multiple instances available. Use the instance number you need for your requirements. If the **Instance** is set to a specific number, such as **0**, use the number specified in the table.

For example, to set a **Description** of **Local LAN** on **Ethernet 0**, enter:

```
eth 0 descr "Local LAN"
```

Because of the space between **Local** and **LAN**, the wording is enclosed in double quotes.

To set an IP address on **192.168.1.1** on **Ethernet 0**:

```
eth 0 ipaddr 192.168.1.1
```

To set an IP address of **172.16.0.1** on **Ethernet 1**:

```
eth 1 ipaddr 172.16.0.1
```

To enable the DHCP client on **Ethernet 2**:

```
eth 2 dhcpcli on
```

Activate and deactivate interfaces

To manually activate (or raise) an interface, type the following command as an activation request:

```
<entity> <instance> act_rq
```

To manually deactivate (or lower) an interface, type the following command as an activation request:

```
<entity> <instance> deact_rq
```

Where **<entity>** can be:

- **PPP** for PPP interfaces
- **TUN** for GRE TUN interfaces
- **OVPN** for OpenVPN interfaces

And **<instance>** is the interface number, such as **0, 1, 2** etc.

For example, to activate **PPP 1**:

```
ppp 1 act_rq
```

To deactivate **PPP 1**:

```
ppp 1 deact_rq
```

ana command: Clear the Analyser Trace

To clear the Analyser trace, type:

```
ana 0 anaclr
```

config command: show/save configuration

The **config** command shows the current or stored configuration settings, saves the current configuration, and specifies which configuration to use when powering up or rebooting the router. The format of the **config** command is:

```
config <0|1|c> <save|saveall|show|showall|powerup>
```

You can store two separate configurations, numbered **0** and **1**. The first parameter of the **config** command specifies to which configuration the command applies. The letter **c** indicates the current configuration settings, such as those currently in use.

The second parameter is one of the following keywords:

- **save** saves the current settings as the specified configuration (either 0 or 1). This is the same functionality as the **Save** button described at [Save the current configuration](#).
- **saveall** saves the configuration as well as default settings to a file config.alx, where x is the config number. This is the same functionality as the **Save All** button described at [Save All: Save the entire configuration](#).
- **show** displays the specified configuration (either 0, 1 or c for the current configuration).
- **showall** shows the config file config.alx, or the current config including all default values.
- **powerup** sets the specified configuration (either 0 or 1) to use at power-up or reboot.

For example, to display the current configuration, type:

```
config c show
```

The output is similar to the following:

```
config c show
eth 0 descr "LAN 0"
eth 0 IPaddr "192.168.1.1"
eth 0 mask "255.255.255.0"
eth 0 bridge ON
eth 1 descr "LAN 1"
eth 2 descr "LAN 2"
eth 3 descr "LAN 3"
eth 4 descr "ATM PVC 0"
```

The configuration files only contain details of those settings that are different from the router's default settings. If you configure a setting that is the same as the default setting, it does not appear in a stored configuration.

To save the current settings to configuration file **1**, type:

```
config 1 save
```

To use configuration file **1** when the powering up or rebooting the router, type:

```
config 1 powerup
```

config changes command: show number of changes counter

The **config changes** command shows the number of changes to the current configuration since the router has powered up and the initial configuration file run. It also shows the time when the configuration file was last saved.

clear command: Clear the event log

To clear the event log, type:

```
clear_ev
```

gpio command: General Purpose Input Output (GPIO)

GPIO commands are necessary to configure a WR44, which has one Digital Input/Output port and one Digital Input port. The **gpio** command configures an I/O port either as an input port or an output port. For example:

Command	Description
gpio inout input	Configures the I/O port as an input.
gpio inout output	Configures the I/O port as an output.
gpio inout on	Sets the I/O port to on when configured as an output.
gpio inout off	Sets the I/O port to off when configured as an output.

The syntax of the command is as follows:

```
gpio [inout ON|OFF|input|output]
```

Display current status of ports

With no parameters, the **gpio** command displays the current status of the ports. For example:

```
gpio
Input(s):
           in : OFF
Output(s):
           inout : OFF
OK
```

Set the I/O port as an output

To set the I/O port to be an output:

```
gpio inout output
Input(s):
           in : OFF
Output(s):
           inout : OFF
OK
```

Set the I/O port to ON when configured as an output

To set the I/O port to **ON** when it is configured as an output:

```
gpio inout on
Input(s):
           in : OFF
Output(s):
           inout : ON
OK
```

The Input and Input/Output connections (pins **2** and **3**) are programmed via the command line using the **gpio** command. The default setting for pins **2** and **3** is **OFF**, as seen in the above example.

Note Use only one of the power connectors. Never apply power to both the **MAIN** and **AUX** connectors at the same time.

Pin	Description
Pin 1	GROUND
Pin 2	INPUT
Pin 3	Input/ Output
Pin 4	Power

The following image shows the pins and the corresponding numbers:

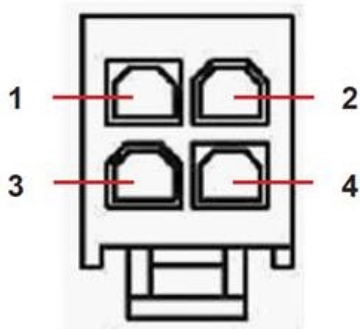

For more information on wiring and other details, see the *4-pin DC Power Cord User Guide*, Digi part number **90001246**.

ping command: Troubleshoot connectivity problems

Use the **ping** command to help troubleshoot connectivity problems. The syntax of the **ping** command is:

```
ping <ip address|FQDN> [n]
```

Where **n** (if specified) is the number of ICMP echo requests to send. If not specified, only **1** echo request is sent.

To stop pings when **n** has been set to a high value, use **ping stop**.

qdl command: Select cellular image to load

The **qdl** command selects which image to load onto a GOBI3000 cellular module. The syntax of the command is:

```
qdl 0 fw <n>
```

where **n** can be **0-14**. The meaning of each value is below. The default value is **0**.

Instance	Value
0	Generic UMTS
1	Verizon
2	Sprint PCS
3	IUSACELL
4	Bell Mobility
5	Alltel
6	Cingular Blue
7	Cingular Orange
8	T-Mobile
9	Docomo
10	Orange
11	Vodafone
12	Telefonica
13	Telital
14	OMH

reboot command: reboot router

The **reboot** command reboots the router after altering the configuration. The **reboot** command executes a complete hardware reset, loading and running the main image from cold. It has three modes of operation:

- **reboot**: Reboots the router after any FLASH write operations have been completed. The following operations allow **1** second to be completed before a reboot occurs:
 - IPSec SA delete notifications are created and sent
 - TCP sockets are closed
 - PPP interfaces are disconnected
- **reboot <n>**: A time reboot; reboots the router in **<n>** minutes where **n** is **1** to **65535**.
- **reboot cancel**: Cancels a timed reboot if entered before the time period has passed.

tcpperm command: establish a permanent serial to IP connection

The **tcpperm** command is available only as an application command, and has no equivalent web page. The **tcpperm** command establishes a permanent “serial to IP” connection between one of the **ASY** ports and a remote IP host. After **tcpperm** executes, the router automatically opens a socket connection to the remote peer whenever data is received from a terminal attached to the specified **ASY** port. When the socket is first opened and the connection is established, the router issues a **CONNECT** message to the terminal and subsequently relays data between the socket and the **ASY** port. You can modify the format of the **CONNECT** message using the standard AT commands (such as **ATV**, **ATE**, etc.) or using the web interface page **Configuration > Network > Interfaces > Serial > Serial Port n**.

Note Preconfigure the serial port to use the appropriate word format, speed, and flow control.

While the serial-to-IP connection is established, if the attached serial device drops the DTR signal, the socket connection is terminated, much as with a standard modem or terminal adapter. You can modify this behavior using the **AT&D** command or the serial port settings.

The format of the command is:

```
TCPPERM <[ASY 0-1]> <Dest Host> <Dest Port> [UDP] [nodeact] [-l<listening port>] [-i<inact_timeout>] [-f<fwd_time>] [-e<eth_ip>] [-d (deact link)] [-k<keepalive_time>] [-s<src_port>] [-ok] [-t<telnet_mode>] [-ho(host only)] [-ssl] [-ao(always open)] [-m<mhome idx>]
```

The **tcpperm** parameters are as follows:

Parameter	Description
ASY	
Dest Host	
Dest Port	
UDP	
-ao	
-e	Use the address of Ethernet port n for the socket connection rather than the default of the address of the interface over which the socket is opened (that is, ppp 1 , ppp 2 , etc.)
-d	Deactivate link. If non-zero, when the socket is closed and there are no other sockets using the interface then the interface connection is dropped (switched connections only).
-f	The forwarding time (x10ms) for packetizing data from the serial port.
-ho	Host. Indicates that the socket should only accept connections from the specified host.
-i	The inactivity timeout (s) after which the socket will be closed.
-k	Keep alive packet timer (s).

Parameter	Description
-l	Listening port. Allows the user to set a new TCP port number to listen on rather than the default value of 4000+ASY port # .
-m	Multihome additional consecutive addresses index
-ok	Open socket in quiet mode, so that there is no OK response to the TCPPERM command.
-s	Source port number
-ssl	Use SSL mode
-t	Use Telnet mode. Opens socket in the corresponding Telnet mode (port 23 default), 0 =raw, 1 =Telnet Mode, 2 =Telnet Mode with null stuffing. If this is not specified, the router uses the mode specified for the associated ASY port in general setup. The -t option sets use of the ok option always.

Use the **tcpperm** command to execute automatically on power-up by using the **cmd n autocmd 'cmd'** macro command. For example:

```
cmd 0 autocmd 'tcpperm asy 0 192.168.0.1 -f3 -s3000 -k10 -e1'
```

Considerations for use with VPN or GRE tunnels

When the socket being used by TCPPERM is opened, the default behavior is to use the address of the interface over which the socket is carried (**ETHn** or **PPPN**) as the source address of the socket. If the socket data is to be tunneled, you may need to use **-en** modifier so the source address of the socket matches the local subnet address specified in the appropriate eroute. You can also set this behavior in the web interface on the **Configuration > Network > Advanced Network Settings** page by setting the parameter **Default source IP address interface: Ethernet n**.

tcpdial command: Establish a manually initiated serial to IP connection

tcpdial operates in an identical manner to **tcpperm**, except that establishment of the socket connection is not automatic and must be initiated by the **tcpdial** command. The simplest method of achieving this is to map a command using the **Configuration > Network > Interfaces > Serial > Command Mappings**, such as, Command to Map **ATDT0800456789** maps to **tcpdial asy 1 217.36.133.29 -e0**. Now, whenever the attached terminal device attempts to dial the number defined, the router maps it to an IP socket connection. In this way, you can direct multiple dial commands to the same or different IP hosts with other simple command mappings.

The **tcpdial** command is available only as an application command, and has no equivalent setting in the web interface.

tcpdab command: Cancel a tcpdial connection

The **tcpdab** command cancels a **tcpdial** connection before the connection has been made. You can also use this command to disconnect an existing **tcpdial** connection on another **ASY** port. The format of the command is:

```
tcpdab <instance> ATH
```

where **<instance>** is the number of the **ASY** port.

templog command: monitor router temperature

The on-board temperature sensors are sampled every **60** seconds. Any interesting changes in the temperature are logged to a special flash file, **templog.c1**. Use **templog 0 status** to view the last stored record in this file.

There are two temperature sensors built in: one on the motherboard and one on the modem module. If a temperature is reached that is outside of normal operating limits, an event will be logged in the **eventlog.txt** file.

traceroute command: Troubleshoot connectivity problems

Use the **traceroute** command to help troubleshoot connectivity problems. The syntax of the **traceroute** command is:

```
traceroute <ip address|FQDN>
```

To stop a failed trace if hosts cannot be detected, use **traceroute stop**.

AT commands

Digi TransPort supports AT commands and Special registers (S registers).

The AT command interface

The **AT** command prefix is for commands that are common to modems. To configure the router using AT commands, you must first connect it to a suitable asynchronous terminal.

1. Set the interface speed/data format for your terminal to **115,200** bits per second, **8** data bits, **no** parity and **1** stop bit. You can change these settings later if necessary.
2. When your terminal is correctly configured, apply power and wait for the **B2** indicator to stop flashing. The device is now ready to respond to commands from an attached terminal and is in **command mode**. Alternatively, you can configure the router to automatically connect to a remote system on powerup.
3. Type **at** (in upper or lower case), and press [**Enter**]. The router should respond with the message **OK**. This message is issued after successful completion of each command. If an invalid command is entered, the router will respond with the message **ERROR**. If there is no response, check that the serial cable is properly connected and that your terminal or PC communications software is correctly configured before trying again. If you have local command echo enabled on your terminal, the AT command may display as **aatt**. If this happens, use the **ate0** command (which appears as **aatee00**), to prevent the router from providing command echo. After entering this command, further commands display without the echo.

Enter multiple commands

After the prefix, you can type one or more commands on the same line, up to **40** characters. When the line is entered, the router will execute each command in turn.

Use escape sequences

If you enter a command such as **atd**, which results in the router successfully establishing a connection to a remote system, it will issue a **CONNECT** result code and switch from command mode to on-line mode. This means that it will no longer accept commands from the terminal. Instead, data will be passed transparently through the router to the remote system. In the same way, data from the remote system will pass straight through to your terminal.

The router will automatically return to command mode if the connection to the remote system is terminated.

To return to command mode manually, you must enter a special sequence of characters called the escape sequence. This consists of three occurrences of the escape character, a pause (user configurable) and then **at**. The default escape character is **+**. The default escape sequence is:

```
+++ {pause} at
```

Entering this sequence when the router is on-line causes the router to return to command mode but it will NOT disconnect from the remote system unless you specifically instruct it to do so by using **ath** or another method of disconnecting. If you have not disconnected the call, use the **ato** command to go back on-line.

AT command result codes

Each time an AT command line executes, the router responds with a result code to indicate whether the command was successful. If all commands entered on the line are valid, the **OK** result code will be issued. If any command on the line is invalid, the **ERROR** result code will be issued.

Result codes may take the form of an English word or phrase (verbose code) or an equivalent number (numeric code), depending on the setting of the **atv** command. The default is to use verbose codes.

Use the **atv0** command to select numeric codes if required. The results from the text based commands can be numeric or verbose. The following table lists the result codes:

Numeric Code	Verbose Code	Meaning
0	OK	Command line executed correctly
1	CONNECT ISDN	connection established
2	RING	Incoming ring signal detected
3	NO CARRIER X.25	service not available
4	ERROR	Error in command line
6	NO DIALTONE ISDN	service not available
7	BUSY	B-channel(s) in use
8	NO ANSWER	No response from remote

S registers

S (Special) registers are registers in the router for storing certain types of configuration information. They are essentially a legacy feature included to provide compatibility with software that was originally designed to interact with modems. See [S register definitions](#) for a list of S registers.

atd: Dial a call

The **atd** command causes the router to initiate an ISDN call. The format of the command depends on the mode of operation.

When using the router to make data calls on one of the ISDN B-channels, enter the **atd** command followed by the telephone number. For example, to dial **01234 567890** enter the command:

```
atd01234567890
```

Spaces in the number are ignored. If the call is successful the router will issue the **CONNECT** result code and switch to on-line mode.

Dialing with a specified sub-address

You can use the ATD command to route a call to an ISDN sub-address by following the telephone with the letter S and the required sub-address. The sub-address can be up to **15** digits long. For example:

```
atd01234567890s003
```

Dialing stored numbers

To dial numbers that have previously been stored within the router using the **AT&Z** command, insert the **S=** modifier within the dial string. For example, to dial stored number **3**, use the command:

```
atds=3
```

Combining ISDN and X.25 calls

A further option for the ATD command for X.25 applications is to combine the ISDN call and the subsequent X.25 CALL in the same command. To do this, follow the telephone number with the **=** symbol and the X.25 call string. For example:

```
atd01234 567890=123456789
```

Pressing any key while the **ATD** command is being executed will abort the call attempt.

ath: Hang-up

The **ath** command terminates an ISDN call. If the router is still on-line, you must first switch back to command mode by entering the escape sequence, such as **+++**, wait **1** second, then enter an AT command or simply **at<CR>**.

After entering the **ath** command, the call is disconnected and the **NO CARRIER** result is issued.

atz: Reset

The **atz** command loads one of the stored profiles for the active ASY port. The command is issued in the format **atzn** where **n** is the number (**0** or **1**) of the ASY port profile you want to load.

at&c: Control the DCD signal

The **at&c** command configures how the router controls the DCD signal to the terminal. Options include:

- **&C0** DCD is always **On**.
- **&C1** DCD is **On** only when an ISDN connection has been established (Layer 2 is **UP**).
- **&C2** DCD is always **Off**.
- **&C3** DCD is normally **On**, but pulses low for a time in 10 millisecond routers, determined by S register **10**.

at&f: Load factory settings

The **at&f** command loads a predefined default set of S-register and AT command settings (the default profile). These settings are:

E1, V1, &C1, &K1, &D2, S0=0, S2=43

All other values are set to **0**.

at&r: Control the CTS signal

The **at&r** command configures how the router controls the CTS signal to the terminal. There are three options:

- **&R0** CTS is always **On**.
- **&R1** CTS follows RTS. The delay between RTS changing and CTS changing is set in AT register **56** in multiples of **10** milliseconds.
- **&R2** CTS is always **Off**.

at&v: View profiles

The **at&v** command displays a list of the current AT command and S register values, and the settings for the two stored profiles. For example:

```
at&v
CURRENT PROFILE:
&c1 &d2 &k1 &s1 &r0 e1 q0 v1 &y0
S0=0 S2=43 S12=50 S31=3 S45=5
states DTR:1 RTS:1

STORED PROFILE 0:
&c1 &d2 &k1 &s1 &r0 e1 q0 v1
S0=0 S2=43 S12=50 S31=3 S45=5

STORED PROFILE 1:
&c1 &d2 &k1 &s1 &r0 e1 q0 v1
S0=0 S2=43 S12=50 S31=3 S45=5
OK
```

at&w: Write SREGS.DAT file

The **at&w** command saves the current command and S registers settings (for the active port), to the file **SREGS.DAT**. You can reload the settings in this file at any time using the **atz** command.

After the **at&w** command, you can specify a profile number, either **0** or **1**, to store the settings in the specified profile. For example, the following command stores the current settings as profile **1**:

```
at&w1
```

If no profile number is specified, profile **0** is assumed.

at&w writes all S register values and the following command settings:

```
e, &c, &d, &k
```

at&y: Select power-up profile

The **at&y** command selects the power-up profile (**0** or **1**). For example, to ensure that the router boots up using stored profile **1**, enter:

```
at&y1
```

at&z: Store phone number

The **at&z** command stores “default” telephone numbers within the router that may subsequently dialed when DTR dialing is enabled or by using the **S=** modifier in the ATD dial command. You can store one telephone number for each **ASY** port. For example, to store the phone number **0800 123456** as the default number to be associated with **ASY 2**, enter:

```
at&z2=0800123456
```

If the number of the **ASY** port is not specified, the number is stored according to the port from which the command was entered. For example, entering this command from **ASY 3**:

```
at&z=0800123456
```

Has the same effect as this command being entered from any port:

```
at&z3=0800123456
```

Once a number is stored, you can dial it from the command line using the **atd** command with the **S=** modifier:

```
atds=3
```

This means that you can dial any stored number from any port. If DTR dialing has been enabled by setting **S33=1** for the port, the number associated with that port is dialed when the **DTR** signal for that port changes from **Off** to **On**. This is because you can use DTR dialing with the number associated with the port to which the terminal is connected only.

at\`\at`: Ignore invalid AT commands

This command is a work-around for use with terminals that generate large amounts of extraneous text. If not ignored, this text can cause many error messages to be generated by the router, and may result in a communications failure. To turn on this feature, type the following command:

```
at\\at=1
```

To turn off the feature, type the following command:

```
at\\at=0
```

When this feature is turned on, the ASY port ignores all commands except real AT commands. As with other ASY modes this can be saved by **at&w** but is not included in the **at&v** status display. To determine whether or not this mode is enabled type:

```
at\\at ?
```

The router displays **0** if the feature is off, **1** if it is on.

at\`\gps` command: Send GPS data to ASY port

The **at\`\gps`** command causes messages from the GPS receiver to be sent directly to the ASY port from which the command has been entered. This requires that the **gpson** parameter is set to **on** for one of the command interpreter instances. For more information on the **gpson** parameter, see [Configure GPS parameters](#).

As soon as the **at\`\gps`** command has been issued, data from the GPS receiver will be sent to that ASY port.

To stop the GPS data, the **+++** escape sequence must be entered, followed by a pause, followed by **at**.

at\ls: Lock speed

The **at\ls** command locks the speed and data format of the port at which it is entered to the current settings so that you can use non-AT application commands.

at\port: Set the active port for text commands

Text commands which affect the settings associated with the serial ports normally operate on the port at which they are entered, such as entering the **at&k** command from a terminal connected to ASY 1 will affect only the flow control settings for port 1.

The **at\port** command selects a different “active” port from that at which the commands are entered. For example, if your terminal is connected to port **0** and you need to reconfigure the settings for port **2**, you would first enter the command:

```
at\port=2
PORT 2
OK
```

Port **2** is now the active port and any AT commands or changes to S registers settings which affect the serial ports will now be applied to port **2** only. This includes:

Commands: **Z, &D, &F, &K, &V, &Y, &W**

S registers: **S31, S45**

The **at\prt?** command displays the port to which you are connected and the active port for command/S register settings. For example:

```
at\prt?
PORT 2
ASY0
OK
```

Here, **ASY2** is the active port and **ASY0** is the port at which the command was entered. If the default port and the port to which you are connected are the same, only one entry will be listed.

To reset the default port to the one to which you are connected, use the **at\port** command without a parameter.

at\smib commands

The **at\smib** command allows you to view a single standard MIB variable. For more information on MIBs and SNMP, see [Use SNMP for remote management](#).

To view the MIB variable, use the **at\smib=mib_name** command, where **mib_name** is the variable to be displayed. The variables are sorted according to the hierarchy shown below.



Commands for displaying system information

The system hierarchy consists of the following:

at\smib=mib-2.system.sysdescr: Show software version information

Shows the software version information; equivalent to what is shown on the **ati5** CLI command output.

```
mib-2.system.sysdescr =
Software Build Ver5121. Jan 31 2011 12:26:04 9W
```

at\smib=mib-2.system.sysobjectid: Show network management subsystem identification

The authoritative identification of the network management subsystem. TransPort does not support outputting OID variables. Instead, **oid** is output.

```
mib-2.system.sysobjectid = oid
```

at\smib=mib-2.system.sysuptime: Show system uptime

Shows the time the router has been running in **10**-millisecond units (hundredths of a second).

```
mib-2.system.sysuptime = 1806718
```

The above example shows that the router has been running for **5 hours, 1 minute and 7.18 seconds**.

at\smib=mib-2.system.syscontact: Show contact information

Shows a description of the contact person for the router. For TransPort, this is always a zero-length string.

at\smib=mib-2.system.sysname: Show router name

Shows the name of the router. This is the name set in the **Router Identity** parameter on the Configuration > System > Device Identity page.

```
mib-2.system.sysname = digi.router
```

at\smib=mib-2.system.syslocation: Show router location

Shows the physical location of the router. For TransPort, this is always a zero-length string.

at\smib=mib-2.system.sysservices: Show router network layer services

Shows a value that represents the set of services the router provides. For each OSI layer, the router provides services for, **2(L-1)** is added to the value, where **L** is the layer. The layers are shown below. For TransPort, this value is always **7** (Physical layer (21-1)+Data Link layer (22-1)+Network layer (23-1)).

Layer	Functionality
1	Physical
2	Data Link
3	Network
4	Transport
5	Session
6	Presentation
7	Application

Commands for displaying interface information

The Interfaces hierarchy consists of the **ifnumber** variable and the **iftable** node:

at\smib=mib-2.interfaces.ifnumber: Show total interfaces on the router

Shows the total number of interfaces on the router. This includes Ethernet, PPP and virtual interfaces (such as IPSec tunnels) and SYNC ports.

```
mib-2.interfaces.ifnumber = 52
```

at\smib=mib-2.interfaces.iftable: Show the interface table

Shows the interface table. The **iftable** node contains **ifentry** nodes for each interface. For each table entry, an index specifier must be appended to the end of each variable (such as for PPP0, 1 must be appended).

at\smib=mib-2.interfaces.iftable.ifentry**at\smib=mib-2.interfaces.iftable.ifentry.ifindex: Show index number for interface**

Displays the unique index number of the interface.

at\smib=mib-2.interfaces.iftable.ifentry.ifdescr: Show information about an interface

Shows information about the interface. This information is displayed in the format **<interface type>-<instance>**, where:

<interface type> can be one of **PPP**, **ETH**, **TUN** (for IPSec tunnels), **SNAIP** (for SNAIP links) or **SYNC**, and

<instance> is the instance.

For example:

```
mib-2.interfaces.iftable.ifentry.ifdescr.1 = PPP-0
```

at\smib=mib-2.interfaces.iftable.ifentry.iftype: Show interface type

Shows the type of interface, as described by the physical/link protocol below the network layer in the protocol stack. Values can be one of the following:

- PPP 23
- ETH 6
- IPSec Tunnel 131
- SNAIP 17
- SYNC port 118

For example:

```
mib-2.interfaces.iftable.ifentry.iftype.1 = 23
```

at\smib=mib-2.interfaces.iftable.ifentry.ifmtu: Show size of largest datagram sent over interface

Shows the size of the largest datagram (in octets) which can be sent on the interface. SNAIP and SYNC ports always return **0**. IPSec tunnel interfaces will return the underlying interface if it can be located, otherwise **0** is returned. PPP interfaces will return the negotiated MTU if the link is connected, otherwise **0** is returned.

For example:

```
mib-2.interfaces.iftable.ifentry.ifmtu.21 = 1504
```

at\smib=mib-2.interfaces.iftable.ifentry.ifspeed: Show interface's current bandwidth

Shows an estimate of the interface's current bandwidth in bits per second. SNAIP and SYNC ports will always return **0**. PPP ports will always return **64000**.

For example:

```
mib-2.interfaces.iftable.ifentry.ifspeed.1 = 64000
```

at\smib=mib-2.interfaces.iftable.ifentry.ifphysaddress: Show interface address

Shows the interface's address at the protocol layer immediately below the network layer in the protocol stack. For interfaces without such an address, a zero-length octet string is returned. For PPP, SNAIP and SYNC ports, a zero-length string is returned.

at\smib=mib-2.interfaces.iftable.ifentry.ifadminstatus: Show administrative state of an interface

Shows the desired state of the interface. The testing state (**3**) indicates no operational packets can be passed.

at\smib=mib-2.interfaces.iftable.ifentry.ifoperstatus: Show operational state of an interface

The current operational state of the interface. The testing state (**3**) indicates no operational packets can be passed.

at\smib=mib-2.interfaces.iftable.ifentry.ifinocets: Show number of octets on an interface

Shows the total number of octets received on this interface, including framing characters.

at\smib=mib-2.interfaces.iftable.ifentry: Show unicast packets delivered by an interface

Shows the number of subnetwork-unicast packets delivered by this interface to a higher-layer protocol.

at\smib=mib-2.interfaces.iftable.ifentry.ifinnucastpkts: Show non-unicast packets delivered by an interface

Shows the number of non-unicast (such as broadcast or multicast) packets delivered by this interface to a higher-layer protocol.

at\smib=mib-2.interfaces.iftable.ifentry.ifinerrors: Show packets received on an interface containing errors

Shows the number of inbound packets received by this interface that contained errors preventing them from being delivered to a higher-level protocol.

at\smib=mib-2.interfaces.iftable.ifentry.ifoutocets: Show octets transmitted by an interface

Show the total number of octets transmitted by this interface, including framing characters.

at\smib=mib-2.interfaces.iftable.ifentry.ifoutucastpkts: Show number of transmitted unicast packets

Shows the total number of packets that higher-level protocols requested this interface to transmit to a subnetwork-unicast address, including those that were discarded or not sent.

at\smib=mib-2.interfaces.iftable.ifentry.ifoutnucastpkts: Show number of transmitted non-unicast packets

Shows the total number of packets that higher-level protocols requested this interface to transmit to a non-unicast (such as broadcast or multicast) address, including those that were discarded or not

sent.

at\smib=mib-2.interfaces.iftable.ifentry.ifouterrors: Show number of outbound packets containing errors

Shows the number of outbound packets that this interface could not transmit because of errors.

Commands for displaying IP node information

The IP node consists of the **ipforwarding** variable and the **ipaddrtable** and **iproutetable** nodes.

at\smib=mib-2.ip.ipforwarding: Show whether router is an IP gateway

Indicates whether the router is acting as an IP gateway in respect to the forwarding of datagrams received by, but not addressed to, the router. IP gateways forward datagrams, IP hosts do not. For the router, this value is always **1**.

at\smib=mib-2.ip.ipaddrtable: Show IP address table

Shows the IP address table. The **ipaddrtable** node contains **ipaddrentry** nodes for each IP address assigned to each interface of the router. For each table entry, an index specifier must be appended to the end of each variable that specifies the interface (such as for **PPP0, 1** must be appended).

at\smib=mib-2.ip.ipaddrtable.ipaddrentry

at\smib=mib-2.ip.ipaddrtable.ipaddrentry.ipadentaddr: Show IP address

Shows the IP address to which this entry's addressing information pertains.

at\smib=mib-2.ip.ipaddrtable.ipaddrentry.ipadentifindex: Show index number for an IP address

Shows the index identifier for the interface associated with this IP address.

at\smib=mib-2.ip.ipaddrtable.ipaddrentry.ipadentnetmask: Show the subnet mask for an IP address

Shows the subnet mask associated with the IP address.

at\smib=mib-2.ip.ipaddrtable.ipaddrentry.ipadentbcastaddr: Show IP broadcast address

Shows the value of the least-significant bit in the IP broadcast address for sending datagrams on the IP address of this interface.

at\smib=mib-2.ip.iproutetable: Show IP route table

Shows the IP route table. The **iproutetable** node contains **iprouteentry** nodes for each route defined on the router.

at\smib=mib-2.ip.iproutetable.iprouteentry

at\smib=mib-2.ip.iproutetable.iprouteentry.iproutedest: Show the destination IP address for the route

Shows the destination IP address for the route. An entry with a value of **0.0.0.0** is considered the default route. Multiple routes to a single destination can appear in the routing table, but access to such multiple entries is dependent on the table-access mechanisms defined by the network management protocol in use.

at\smib=mib-2.ip.iproutetable.iprouteentry.iprouteifindex: Show index number for next hop of the route

Shows the index value which uniquely identifies the local interface through which the next hop of the route should be reached.

at\smib=mib-2.ip.iproutetable.iprouteentry.iproutemetric1: Show the metric for a route

Shows the primary routing metric for the route.

at\smib=mib-2.ip.iproutetable.iprouteentry.iproutenexthop: Show the IP address of the next hop of the route

Shows the IP address of the next hop of the route.

at\smib=mib-2.ip.iproutetable.iprouteentry.iproutetype: Show route type

Shows the type of route. Valid values are:

1. Valid
2. Invalid
3. Direct
4. Indirect

at\smib=mib-2.ip.iproutetable.iprouteentry.iproutemask: Show the netmask for the route

Shows the netmask for the route.

S register definitions

In addition to the AT commands there are a number of Special (“S”) registers. These registers contain numeric values that may represent time intervals, ASCII characters or operational flags.

To display the contents of a particular “S” register, use the **ats** command in the form **atsn?** where **n** is the number of the register for which contents are shown.

To store a new value into a register, use the S command in the form **atsn=x** where **n** is the number of the register to be changed and **x** is the new value. For example, **ats31=4** stores the value 4 in **S31**.

The router maintains one set of registers for each ASY port. By default, the S command operates ONLY on the S register set for the active port. To select an alternative default port, use the **at\port** command first.

Each register can only be set to a limited range of values as shown in the table below:

Register	Description	Units	Default	Range
S0	V.120 Answer enable	Rings	0	0-255
S1	Ring count	Rings	n/a	n/a
S2	Escape character	ASCII	43	0-255
S9	DCD on delay	ms x 20	0	0-255
S10	Pulse time for DCD Low	ms x 10	0	0-255
S12	Escape delay	ms	50	0-255
S15	Data forwarding timer	ms	2	0-255
S16	RS422/485 serial port settings	N/A	0	0, 2, 3
S23	Parity	N/A	0	0-2 5 6
S31	ASY interface speed	refer to full description	n/a	0-11
S33	DTR dialing	N/A	0	0 1
S45	DTR loss de-bounce	0.05 seconds	(0.25s)	1-255

S0: V.120 answer enabled

Units: Rings

Default: 0

Range: 0-255

Used in V.120 mode only. Enables or disables automatic answering of incoming ISDN calls. Auto answering is disabled when **S0** is set to the default value of 0. Setting **S0** to a non-zero value enables auto-answering.

The actual value stored determines the number of “rings” that the router will wait before answering. For example, the command **ATS0=2** enables auto-answering after two incoming rings have been detected.

With each ring the RING result code is issued and the value stored in **S1** is incremented. When the value in **S1** equals the value in **S0** the call is answered.

S1: Ring count

Units: Rings
Default: n/a
Range: n/a

When ADAPT detects an incoming ISDN call on an ASY port, it will print **RING** to the ASY port at 2 second intervals. It also increments the **S1** register, counting how many times **RING** is printed.

S2: Escape character

Units: ASCII
Default: 43
Range: 0-255

The value stored in **S2** defines which ASCII character is the Escape character. By default, the escape character is the **+** symbol. Entering this character three times followed by a delay of 1-2 seconds and then an AT command causes the router to switch from on-line mode to command mode.

S12: Escape delay

Units: ms
Default: 50
Range: 0-255

The value stored in **S12** defines the delay between sending the escape sequence and entering an AT command for the router to switch from on-line mode to command mode.

S15: Data forwarding timer

Units: 10ms
Default: 0
Range: 0-255

S15 sets the data forwarding timer for the ASY port in multiples of 10ms. The default data forwarding time is **20** milliseconds. Normally, there is no need to change this setting. However, setting **S15** to **1** enables a special mode of operation in which data is forwarded as fast as possible for the data rate for which the port is configured (at **115000** bits per second, this will typically be **2-3** milliseconds).

Note that the default value of **0** is equivalent to setting the register to **2** to maintain compatibility with older systems.

S16: RS422/485 serial port settings

The RS485 option is only available on specific hardware versions.

Units: N/A
Default: 0
Range: 0, 2, 3, where **0**=RS232, **2**=RS485 full duplex, **3**=RS485 half duplex

Following example shows how to setup and save **ASY 0** in 485 half-duplex mode

```
AT\port=0
```

```
ATS16=3
```

```
AT&w
```

```
AT\port
```

The **at\port=0** is needed to ensure that subsequent AT commands are directed to the right port (ASY0). The port settings can be saved permanently using **at&w**.

Issue the command `ats16?` and check that the value of this S register is **3**. To set it back to RS232 then set **ats16** to **0** and save it with the **at&w** command.

S23 Parity

Units: N/A
 Default: 0
 Range: 0-2,5,6

The value stored in **S23** determines whether the parity for the ASY port is set to **None (0)**, **Odd (1)**, **Even (2)**, **8DataOdd (5)** or **8DataEven (6)**.

S31 ASY Interface Speed

Units: N/A
 Default: 0
 Range: 0-11

Register **S31** sets the speed and data format for the ASY port to which you are currently connected. The default value for **ASY 0** is 0, such as the port speed/data format is not set to a specific value, it is determined automatically from the AT commands that you enter.

The default value for **ASY 1, 2, and 3** is **3**, meaning the ports only accept AT commands at **115,200** bits per second (**8** data bits, **no** parity and **1** stop bit).

To set the speed of one of the ports to a particular value, set the appropriate register to the required value from the following table:

S31	Port Speed (bps)	S31	Port Speed (bps)
0	Auto-detect	6	19200
1	Reserved	7	9600
2	Reserved	8	4800
3	115200	9	2400
4	57600	10	1200
5	38400	11	300

For example, to change the speed of **ASY 1** to **38,400** bits per second:

1. Connect your terminal to that port with the speed set to **9600** bits per second.
2. Enter the command:

```
ats31=5
```

3. Change the speed of your terminal to **38,400** bits per second before entering any more AT commands.

When entering the **ats31=n** command, the data format selected becomes the data format for all further commands.

The auto-detect option is only available for **ASY0** and **ASY1**.

S33: DTR dialing

Units: N/A

Default: 0

Range: 0, 1

S33 enables or disables DTR dialing for the port. When DTR dialing is enabled, the router dials the number stored for that port (see **atz: Reset**) when the DTR signal from the terminal changes from **Off** to **On**.

S45: DTR loss de-bounce

Units: 0.05 seconds

Default: 5

Range: 1-255

The value in **S45** determines the length of time for which the DTR signal from the terminal device must go off before the router acts upon any options that are set to trigger on loss of DTR. Increasing or decreasing the value in **S45** makes the router less or more sensitive to “bouncing” of the DTR signal respectively.

Configuring network interfaces

Configure Ethernet interfaces	182
Configure Wi-Fi interfaces	211
Configure mobile (cellular) interfaces	226
Configure DSL interfaces	260
Configure Generic Routing Encapsulation (GRE) interfaces	270
Configure ISDN interfaces	276
Configure PSTN interfaces	296
Configure DialServ interfaces	305
Configure serial interfaces	314
Configure IPv6 addressing support	338
Configure PPP and external modems	360

Configure Ethernet interfaces

Web

Go to **Configuration > Network > Interfaces > Ethernet**.

The **Configuration > Network > Interfaces > Ethernet** page displays configuration pages for each of the available Ethernet instances on the router. Each page allows the user to configure parameters such as the IP address, mask, gateway, and others.

On routers with only one Ethernet port, if more than one Ethernet instance exist these are treated as logical Ethernet ports. You can use these instances to assign more than one Ethernet IP address to a router.

On routers with more than one physical Ethernet port, the Ethernet instances refer to the different physical Ethernet ports. These routers can be configured for either **HUB** mode or **Port Isolate** mode.

In HUB mode all the Ethernet ports are linked together and behave like an Ethernet hub or switch. This means that the router will respond to all of its Ethernet IP addresses on all of its ports (as the hub/ switch behavior links the ports together).

In Port Isolate mode, the router will only respond to its **Ethernet 0** IP address on physical port **LAN 0**, its **Ethernet 1** IP address on physical port **LAN 1**, etc. The router will not respond to its Ethernet 1 address on port **LAN 0** unless routing has been configured appropriately.

When configured for HUB mode it is important that no more than one of the router's ports is connected to another hub or switch on the same physical network. Otherwise an Ethernet loop can occur. The default behavior is **HUB** rather than **Port Isolate**.

VLAN tagging is **not** available when the router is configured for Port Isolate mode.

IPv6 addressing support on Ethernet interfaces

TransPort routers support IPv6 addressing on Ethernet interfaces only, and on a limited number of Ethernet interfaces. For more information, see [Configure IPv6 addressing support](#).

Configure basic Ethernet IP address parameters

Note To configure the Ethernet interface to support IPv6 addressing, see [Configure IPv6 addressing support](#).

Web

- Go to **Configuration > Network > Interfaces > Ethernet > ETH n**.
The **Configuration > Network > Interfaces > Ethernet > ETH n** initial view only shows basic IP address parameters. The choice is to obtain an IP address by using a DHCP server or to manually configure the IP addressing for this interface.

Interfaces
 Ethernet
 ETH 0
 Description:
 Get an IP address automatically using DHCP
 Override these DHCP server values:
 Mask:
 Gateway:
 DNS Server:
 Secondary DNS Server:
 Use the MAC address as the client ID
 Use the following settings
 Changes to these parameters may affect your browser connection

- Configure basic Ethernet IP address settings:

Description

Use a memorable name for this Ethernet instance, to make it easier to identify.

Get an IP address automatically using DHCP

Enables the DHCP client on this interface. You can elect to override the DHCP server settings for the **Mask**, **Gateway**, **DNS Server**, and **Secondary DNS Server**.

Use the following settings

Enables manual configuration of the IP addressing parameters

IP Address

Specifies the IP address of this Ethernet port on your LAN.

Mask

The subnet mask of the IP subnet to which the router is attached via this Ethernet port. Typically, this would be **255.255.255.0** for a Class C network.

Gateway

The IP address of a gateway the router uses. IP packets whose destination IP addresses are not on the LAN to which the router is connected are forwarded to this gateway.

DNS Server / Secondary DNS Server

The IP address of DNS servers the router uses for resolving IP hostnames.

Note If the IP address, Mask, Gateway, DNS server or Secondary DNS server parameters are specified manually, but the option to use a DHCP server is later selected, any existing manually specified parameters will override the DHCP supplied parameters. To change from manual configuration to DHCP, be sure to remove all manually specified parameters first.

3. Click **Apply**.

**Command line**

Command	Instance	Parameter	Values	Equivalent web parameters
eth	n	descr	Free text field	Description
eth	n	ipaddr	Valid IP address	IP Address
eth	n	mask	Valid Subnet Mask	Mask
eth	n	gateway	IP address	Gateway
eth	n	dnsserver	IP address	DNS Server
eth	n	secdns	IP address	Secondary DNS Server
eth	n	dhcpccli	on, off	On=Get an IP address automatically using DHCP Off=Use the following IP address
eth	n	ipv6_mode	off, wan, lan	Configuration > Network> Interfaces > IPv6 > ???
eth	n	ipv6_wan	0, <number of ipv6_wan parameter instances>, 1	Configuration > Network> Interfaces > IPv6 WAN settings
eth	n	ipv6_lan	0, <number of ipv6_wan parameter instances>, 1	Configuration > Network> Interfaces > IPv6 WAN settings
eth	n	vrf	integer	VRF
eth	n	vrfexport	integer	VRFexport

Configure advanced Ethernet parameters

On routers with only one Ethernet port, there may be multiple configurable Ethernet instances. **Ethernet 0** is the physical interface. These extra instances are treated as logical Ethernet ports. You can use them to assign more than one Ethernet IP address to a router.

On routers with more than one physical Ethernet port, the Ethernet instances refer to the different physical Ethernet ports. These routers can be configured for either **HUB** mode or **Port Isolate** mode. In HUB mode all the Ethernet ports are linked together and behave like an Ethernet hub or switch. This means that the router will respond to all of its Ethernet IP addresses on all of its ports (as the hub/ switch behavior links the ports together).

In Port Isolate mode, the router will only respond to its **Ethernet 0** IP address on physical port **LAN 0**, its Ethernet 1 IP address on physical port **LAN 1**, etc. The router will not respond to its Ethernet 1 address on port **LAN 0** unless routing has been configured appropriately.

When configured for **HUB** mode, no more than one of the router's Ethernet interfaces should be connected to another hub or switch on the same physical network otherwise an Ethernet loop can occur. The default behavior is **HUB** rather than Port Isolate.

Web

1. Go to **Configuration - Network > Interfaces > Ethernet > ETH n > Advanced**.
2. Configure the advanced Ethernet settings as needed:

Advanced

This device is currently in Hub mode [Switch to Port Isolate mode](#)

Ethernet Hub group:

Metric:

MTU:

Enable auto-negotiation

Speed (currently 100Base-T): Auto 10Base-T 100Base-T

Duplex: Auto Full Duplex Half Duplex

Max Rx rate: kbps

Max Tx rate: kbps

TCP transmit buffer size: bytes

Take this interface out of service after seconds when the link is lost (e.g. cable removed or broken)

- Enable NAT on this interface
- Enable IPsec on this interface
- Enable the firewall on this interface
- Enable DNS inbound blocking
- Enable DMNR advertisement from this subnet

Remote management access:

Multihome additional consecutive addresses:

- Respond to ARP requests only if the requestor is of this network
- Enable IGMP on this interface
- Enable Bridge on this interface
- Generate Heartbeats on this interface
- Generate Ping packets on this interface

Port Isolate mode

If the router is running in Port Isolate mode, the following will be displayed, with an option to switch to Hub mode.

Hub Mode (factory default)

If the router is running in Hub mode, the following is displayed, with an option to switch to Port Isolate mode.

Ethernet Hub group

On routers with a built-in hub/switch, the Ethernet Hub group parameter for each port is normally set to 0. This means that all ports belong to the same hub. If required, you can use the

Ethernet Hub group parameter to isolate specific ports to create separate hubs. For example, if **Ethernet 0** and **Ethernet1** have their Group parameter set to **0** and **Ethernet 2** and **Ethernet 3** have their Group parameter set to **1**, the router is configured as two 2-port hubs instead of one 4-port hub. This means that traffic on physical ports **LAN 0** and **LAN 1** is not visible to traffic on physical ports **LAN 2** and **LAN 3** (and vice versa). Group numbers can be **0-3** or use **255** for an interface to be in all groups. This parameter is not available on the web page when the router is configured for Port Isolate mode.

Metric

The connected metric of an interface. Changing this value will alter the metric of dynamic routes created automatically for this interface. The default metric of a connected interface is 1. By allowing the interface to have a higher value (lower priority), static routes can take preference to interface-generated dynamic routes. For normal operation, leave this value unchanged.

MTU

The Maximum Transmit Unit for the specified interface. The default value is **0**, meaning that the MTU will either be **1504** (for routers using a Kendin Ethernet device) or **1500** (for non-Kendin devices). The non-zero values must be greater than 128 and not more than the default value. Values must also be multiples of 4 and the router will automatically adjust invalid values entered by the user. For example, if the MTU is set to **1000**, the largest IP packet that the router will send is **1000** bytes.

Enable auto-negotiation

Allows the router and a connected Ethernet device to auto-negotiate the speed and duplex of the Ethernet connection.

Speed (currently 100Base-T)

Select either of the **10Base-T**, **100Base-T**, or **Auto** modes. The currently selected mode is shown in brackets after the parameter name. Enabling Auto-negotiation and manually setting the speed allows only the selected speed to be negotiated.

Duplex

Select either of **Full Duplex**, **Half Duplex** or **Auto** mode. Enabling **Auto-negotiation** and manually setting the Duplex will only allow the selected Duplex mode to be negotiated.

Max Rx rate

On models with multiple Ethernet interfaces, this parameter specifies a maximum data rate in Kbps that the router receives on this interface. This may be useful in applications where separate Ethernet interfaces are allocated to separate LANs and it is necessary to prioritize traffic from one LAN over another.

Max Tx rate

On models with multiple Ethernet interfaces, this parameter specifies a maximum data rate in kbps that the router will transmit on this interface. This may be useful in applications where separate Ethernet interfaces are allocated to separate LANs and it is necessary to prioritize traffic from one LAN over another.

TCP transmit buffer size

When set to a non-zero value, this parameter sets the TCP buffer size of transmitted packets in bytes. This is useful for slow / lossy connections such as satellite. Setting this buffer to a low value will prevent the amount of unacknowledged data from getting too high. If retransmits are required, a smaller TX buffer helps prevent the flooding of the connection by retransmits.

Take this interface out of service after n seconds when the link is lost (such as cable removed or broken)

The length of time, in seconds, the router will wait after detecting that an Ethernet cable has been removed before routes that were using that interface are marked as out of service. If the parameter is set to 0, the feature is disabled and routes using the interface will not be marked as out of service if the cable is removed.

Take this interface out of service after seconds when the link is lost (e.g. cable removed or broken)

Enable NAT on this interface
 IP address IP address and Port

Enable IPsec on this interface
 Keep Security Associations (SAs) when this ETH interface is disconnected
 Use interface for the source IP address of IPsec packets

Enable the firewall on this interface

Enable DNS inbound blocking

Enable DMNR advertisement from this subnet
 Use tunnel TUN to advertise this subnet on

Enable NAT on this interface

Selects whether the Ethernet interface uses IP, Network Address Translation (NAT), or Network Address and Port Translation (NAPT). When the parameter is disabled, no NAT occurs. When enabled, extra options are displayed, described below.

NAT and NAPT have many uses, but the router generally uses them to allow a number of private IP hosts (PCs for example) to connect to the Internet through a single shared public IP address. This has two main advantages: it saves on IP address space (the ISP only need assign you one IP address), and it isolates the private IP hosts from the Internet (effectively providing a simple firewall because unsolicited traffic from the Internet cannot be routed directly to the private IP hosts).

To use NAT or NAPT correctly in the example of connecting private hosts to the Internet, NAT or NAPT should be enabled on the router's WAN side interface and should be disabled on the router's LAN side interface.

IP address

When a private IP host sends a UDP or TCP packet to an Internet IP address, the router will change the source address of the packet from the private host IP to the router's public IP address before forwarding the packet onto the Internet host. Additionally it will create an entry in a **NAT table** containing the private IP source address, the private IP port number, the public IP destination address and the destination port number. Conversely, when the router receives a reply packet back from the public host, it checks the source IP, source port number and destination port number in the NAT table to determine which private host to forward the

packet to. Before it forwards the packet back to the private host, it changes the destination IP address of the packet from its public IP address to the IP address of the private host.

IP address and Port

This mode behaves like NAT, but in addition to changing the source IP of the packet from the private host, it can also change the source port number. This is required if more than one private host attempts to connect using the same local port number to the same Internet host on the same remote port number. If such a scenario were to occur with NAT, the router would be unable to determine which private host to route the returning packets to, and the connection would fail.

Enable IPsec on this interface

Enables or disables IPsec security features for this Ethernet interface.

Use interface x,y for the source IP address of IPsec packets

By default, the source IP address for an IPsec route is the IP address of the interface on which IPsec was enabled. By setting this parameter to either **PPP** or **Ethernet** and the relevant interface number, the source address IPsec uses matches that of the Ethernet or PPP interface specified.

Enable the firewall on this interface

Turns Firewall script processing On or Off for this interface.

Enable DNS inbound blocking

Enables or disables blocking DNS requests on the Ethernet interface, to prevent the interface from responding to DNS requests over this interface.

Enable DMNR advertisement from this subnet

Enables or disables the subnet defined on the Ethernet interface to be advertised on any defined Dynamic Mobile Network Routing (DMNR) tunnel. DMNR is available on Verizon Wireless Private Networks. DMNR provides direct access to devices on the Local Area Network (LAN) at your company's sites by dynamically advertising locally IP subnets attached to the router's Ethernet interface(s). Contact Verizon Wireless for more details on DMNR and whether your network uses DMNR or is eligible for DMNR. For more information on configuring DMNR, see the Digi document Application Note 53: Configure a Digi TransPort Router to use DMNR (Dynamic Mobile Network Routing), available on www.digi.com.

Remote management access

The Remote access options parameter can be set to **No restrictions**, **Disable management**, **Disable return RST**, or **Disable management and return RST**.

Remote management access:

Multihome additional consecutive addresses:

Respond to ARP requests only if the requestor is of this network

Enable IGMP on this interface

Enable Bridge on this interface

Bridge Instance:

- When set to **No restrictions**, users on this interface can access the router's Telnet, FTP, and web services for the purpose of managing the router.
- When set to **Disable management**, users on this interface are prevented from managing the router via Telnet, FTP, or the web interface.
- For **Disable return RST**, whenever a router receives a TCP SYN packet for one of its own IP addresses with the destination port set to an unexpected value, such as a port that the router would normally expect to receive TCP traffic on, it will reply with a TCP RST packet. This is normal behavior. However, the nature of internet traffic is such that whenever an internet connection is established, TCP SYN packets are to be expected. As the router's PPP inactivity timer is restarted each time the router transmits data (but not when it receives data), the standard response of the router to SYN packets such as transmitting an RST packet, will restart the inactivity timer and prevent the router from disconnecting the link even when there is no genuine traffic. This effect can be prevented by using the appropriate commands and options within the firewall script. However, on Digi 1000 series routers, or where you are not using a firewall, the same result can be achieved by selecting this option, such as when this option is selected the normal behavior of the router in responding to SYN packets with RST packets is disabled. The option will also prevent the router from responding to unsolicited UDP packets with the normal ICMP destination unreachable responses.
- The **Disable management & return RST** option prevents users from managing the router via the Telnet, FTP, and web interfaces and also disables the transmission of TCP RST packets as above.

Multihome additional consecutive addresses

Defines how many additional (consecutive) addresses the Ethernet driver will own. For example, if the IP address of the interface is **10.3.20.40**, and **Multihome additional consecutive addresses** is set to **3**, the IP addresses **10.3.20.41**, **10.3.20.42**, and **10.3.20.43** also belong to the Ethernet interface.

Enable IGMP on this interface

Enables or disables the Internet Group Management Protocol for this Ethernet interface.

Enable Bridge on this interface

Bridge mode only applies to models with built-in Wi-Fi. If Wi-Fi is enabled, you must enable bridge mode on **Eth 0**. This creates an Ethernet bridge between the Wi-Fi access point and the

physical Ethernet interface.

Generate Heartbeats on this interface

Enabling this option displays the parameters for heartbeat packets. These are UDP packets that can contain status information about the router. You can use them in conjunction with Remote Manager.

Send Heartbeat messages to IP address a.b.c.d every h hrs m mins s seconds

For this setting, **a.b.c.d** specifies the destination IP address for heartbeat packets and h, m and s specifies how often the router will transmit heartbeat packets to the specified destination in (**h**) Hours, (**m**) Minutes and (**s**) Seconds.

Use interface x,y for the source IP address

By default, heartbeat packets is sent with the source IP address of the interface on which they were generated. If the heartbeat is required to be sent via an IPSec tunnel, use this parameter to specify the source IP address of the heartbeat packet to ensure the source and destination match the eroute selectors.

Select the transmit interface using the routing table

When enabled, the UDP heartbeats chooses the best route from the routing table. If disabled the exit interface will be interface on which the heartbeat is configured.

Include IMSI information in the Heartbeat message

When enabled, the heartbeat includes the IMSI of the cellular module.

Include GPS information in the Heartbeat message

When enabled and the appropriate GPS hardware is installed, the heartbeat includes the GPS co-ordinates of the router.

Generate Ping packets on this interface

Enabling this option displays the parameters for enabling auto-pings to be transmitted from this interface. The interface can monitor these pings. If auto-pings were enabled on and if there is no ping reply, the router takes the interface out of service for a specified amount of time, before allowing use of the interface again. Another option is to enable auto-pings on this interface and let the firewall handle taking the interface out of service in the event of a failure. Both methods are explained in Application Notes on your TransPort product's **Product Support** page.

Generate Ping packets on this interface

Send byte pings to IP host every hrs mins seconds

Switch to sending pings to IP host after failures

Ping responses are expected within seconds

Only send Pings when this Ethernet interface is "In Service"

No PING response request interval (s):

Take this interface "Out of Service" after receiving no responses for seconds

Keep this interface out of service for seconds

Send n byte pings to IP host a.b.c.d every h hrs m mins s seconds

For this setting, **n** specifies the payload size of a ping packet when using the auto ping feature. Leaving this parameter blank uses the default value. The address **a.b.c.d** specifies the destination IP address for auto-ping ICMP echo request. The values **h**, **m** and **s** specifies how often the router transmits Auto-ping packets to the specified destination in (h) Hours, (m) Minutes and (s) Seconds.

Switch to sending pings to IP host a.b.c.d after n failures

For this setting, **a.b.c.d** specifies an alternative destination IP address for the auto-ping ICMP echo request to be sent to, should the main IP address specified in the parameter above fail to respond. This allows the router to double check there is a problem with the connection and not just with the remote device not responding. The value **n** specifies the number of pings that must fail before the checking the second IP address. The extra IP address check is only enabled if this parameter is set to something other than **0**.

Only send Pings when this Ethernet interface is "In Service"

If this parameter is enabled, this interface sends ICMP echo requests when it is in service only. The default setting is disabled; ICMP echo requests are sent when the interface is in service and out of service.

Take this interface "Out of Service" after receiving no responses for s seconds

The length of time, in seconds, before a route will be designated as being out of service if there has been no response to ANY of the ICMP echo requests during that time period.

Keep this interface out of service for s seconds

The length of time, in seconds, for which any routes using this Ethernet interface are held out of service after a ping failure is detected.

3. Click **Apply**.

 **Command line**

Command	Instance	Parameter	Values	Equivalent web parameter
n/a	n/a	ethvlan	n/a	Switch to Port Isolate Mode
n/a	n/a	ethhub	n/a	Switch to Hub Mode

Command	Instance	Parameter	Values	Equivalent web parameter
eth	n	group	0-3,255	Ethernet Hub group
eth	n	metric	1-16	Metric
eth	n	mtu	64-1500	MTU
eth	n	auton	0, 1	Enable auto-negotiation
eth	n	speed	0, 10, 100	Speed 0=Auto 10=10-BaseT 100=100-BaseT
eth	n	duplex	0, 1, 2	Duplex 0=Auto 1=Full 2=Half
eth	n	maxkbps	value in kbps	Max Rx rate
eth	n	maxtkbps	value in kbps	Max Tx rate
eth	n	tcptxbuf	value in bytes	TCP transmit buffer size
eth	n	linkdeact	0-86400	Take this interface out of service after n seconds when the link is lost
eth	n	do_nat	0, 1, 2	Enable NAT on this interface 0=Disabled 1=IP address 2=IP address and Port
eth	n	ipsec	0, 1	Enable IPsec on this interface
eth	n	ipsecent	blank, eth, ppp	Use interface x,y for the source IP address of IPsec packets x=Interface type
eth	n	ipsecadd	0-255	Use interface x,y for the source IP address of IPsec packets y=interface number
eth	n	firewall	0, 1	Enable the firewall on this interface
eth	n	block_dns	on, off	Enable DNS inbound blocking
eth	n	dmnr_reg	on, off	Enable DMNR advertisement from this subnet
eth	n	nocfg	0, 1, 2, 3	Remote management access 0=No restrictions 1=Disable management 2=Disable return RST 3=Disable management and return RST

Command	Instance	Parameter	Values	Equivalent web parameter
eth	n	mhome	0-255	Multihome additional consecutive addresses
eth	n	igmp	0, 1	Enable IGMP on this interface
eth	n	bridge	0, 1	Enable Bridge on this interface
eth	n	heartbeatip	IP address	Send Heartbeat messages to IP address a.b.c.d every h hrs m mins s seconds
eth	n	hrtbeatint	0-86400	Send Heartbeat messages to IP address a.b.c.d every h hrs m mins s seconds This CLI value is entered in seconds only.
eth	n	hbipent	blank, eth, ppp	Use interface x,y for the source IP address x=Interface type
eth	n	hbipadd	0-255	Use interface x,y for the source IP address y=interface number
eth	n	hbroute	0, 1	Select the transmit interface using the routing table
eth	n	hbimsi	0, 1	Include IMSI information in the Heartbeat message

Configure Ethernet Quality of Service (QoS) parameters

Web

- Go to **Configuration > Network > Interfaces > Ethernet > ETH n > QoS**.
The parameters on the **QoS** page control the Quality of Service management facility. Each Ethernet interface has an associated QoS instance, where ETH 0 maps to QoS 5, ETH 1 maps to QoS 6 and so on. These QoS instances include ten QoS queues into which packets may be placed when using QoS. Each of these queues must be assigned a queue profile from the twelve available.

▼ QoS

Enable QoS on this interface

Link speed: kbps

Queue	Profile	Priority
0	0 ▼	Very High ▼
1	1 ▼	High ▼
2	2 ▼	Medium ▼
3	3 ▼	Low ▼
4	4 ▼	Very Low ▼
5	4 ▼	Very Low ▼
6	4 ▼	Very Low ▼
7	4 ▼	Very Low ▼
8	4 ▼	Very Low ▼
9	4 ▼	Very Low ▼
10	4 ▼	Very Low ▼
11	4 ▼	Very Low ▼
12	4 ▼	Very Low ▼
13	4 ▼	Very Low ▼
14	4 ▼	Very Low ▼

- Enter the QoS parameters as needed:

Enable QoS on this interface

When enabled, displays the following QoS configuration parameters:-

Link speed n Kbps

Set this setting to the maximum data rate that this PPP link is capable of sustaining. The router uses this setting when calculating whether or not the data rate from a queue can exceed its minimum Kbps setting, as determined by the profile assigned to it and send at a higher rate (up to the maximum Kbps setting).

Queue n

Below this column heading is a list of ten queue instances. Each instance is associated with the profile and priority on the same row.

Profile n

This column contains the profile to be associated with the queue. There are twelve available, **0-11**, selected from the drop-down list boxes.

Priority

This column contains drop-down menu boxes for assigning a priority to the selected queue. The priorities available are **Very High, High, Medium, Low**, and **Very Low**.

3. Click **Apply**.

**Command line**

Command	Instance	Parameter	Values	Equivalent web parameter
qos	n	linkkbps	Integer	Link speed n kbps
qos	n	q0prof	0-11	Queue 0 Profile
qos	n	q0prio	0-4 0=Very high 1=High 2=Medium 3=Low 4=Very Low	Queue 0 Priority
qos	n	q1prof	0-11	Queue 1 Profile
qos	n	q1prio	0-4	Queue 1 Priority
qos	n	q2prof	0-11	Queue 2 Profile
qos	n	q2prio	0-4	Queue 2 Priority
qos	n	q3prof	0-11	Queue 3 Profile
qos	n	q3prio	0-4	Queue 3 Priority
qos	n	q4prof	0-11	Queue 4 Profile
qos	n	q4prio	0-4	Queue 4 Priority
qos	n	q5prof	0-11	Queue 5 Profile
qos	n	q5prio	0-4	Queue 5 Priority
qos	n	q6prof	0-11	Queue 6 Profile
qos	n	q6prio	0-4	Queue 6 Priority
qos	n	q7prof	0-11	Queue 7 Profile
qos	n	q7prio	0-4	Queue 7 Priority
qos	n	q8prof	0-11	Queue 8 Profile
qos	n	q8prio	0-4	Queue 8 Priority

Command	Instance	Parameter	Values	Equivalent web parameter
qos	n	q9prof	0-11	Queue 9 Profile
qos	n	q9prio	0-4	Queue 9 Priority

Configure Ethernet Virtual Router Redundancy Protocol (VRRP)

VRRP (Virtual Router Redundancy Protocol) allows multiple physical routers to appear as a single gateway for IP communications in order to provide back-up WAN communications in the event that the primary router in the group fails in some way. It works by allowing multiple routers to monitor data on the same IP address. One router is designated as the master of the address and under normal circumstances it will route data as usual. However, the VRRP protocol allows the other routers in the VRRP group to monitor the master and if they detect that it is no longer operating, negotiate with each other to take over the role as owner. The protocol also facilitates the automatic re-prioritization of the original owner when it returns to operation.

Web

1. Go to **Configuration > Network > Interfaces > Ethernet > ETH n > VRRP**.

VRRP

Enable VRRP on this interface

VRRP Group ID:

VRRP Priority:

Send advertisements every seconds when in MASTER mode

Switch to MASTER mode if no advertisements are received within seconds

Delay VRRP startup by seconds after the ethernet interface connects

Boost the priority by for seconds after switching to the MASTER state

Enable VRRP+ Probing

Adjust priority according to status of another VRRP

2. Enter VRRP parameters:

Enable VRRP on this interface

Enables VRRP on this interface.

VRRP Group ID

The VRRP group ID parameter identifies routers that are configured to operate within the same VRRP group. The default value is 0 which means that VRRP is disabled on this Ethernet interface. The value may be set to a number from **1** to **255** to enable VRRP and include this Ethernet port in the specified VRRP group.

VRRP Priority

The priority level of this Ethernet interface within the VRRP group from **0** to **255**. **255** is the highest priority and setting the priority to this value would designate this Ethernet interface as the initial master within the group. The value selected for the VRRP priority should reflect the values selected for other routers within the VRRP group, such as no two routers in the group should be initialized with the same value.

Boost the priority by n for s seconds after switching to the MASTER state

Increases the VRRP priority by the specified amount for the specified amount of time when the router has become the VRRP group master. This option can be used to provide network stability when the original master cycles between on- and offline, causing repeated VRRP state switches.

Enable VRRP+ Probing

Enables VRRP+ probing on this Ethernet interface. VRRP+ probing allows a secondary router to take over as master under a wider range of activity, by dynamically adjusting the VRRP priority of an interface and if necessary, changing the status of that interface from master to backup or vice-versa. It does this by probing an interface, either by sending an ICMP echo request (PING) or by attempting to open a TCP socket to the specified Probe IP address.

Enable VRRP+ Probing

Send ▼ probe to IP address TCP port

every seconds when in Backup state

every seconds when in Master state

Adjust priority by ▼ after probe failures

Reset probe failure count after probe successes

Use interface ▼ over which to send probe

Get the source IP address from interface ▼

Send p probe to IP address a.b.c.d TCP port n

Configures VRRP+ to send a probe packet to the appropriate IP address and TCP port. The TCP port is needed if the probe type is **TCP**. The routing code determines which interface to use. This allows the router to test other interfaces and adjust the VRRP priority according to the status of that interface. For example, the user may wish to configure probing in such a way that the Digi router WAN interface is tested, and adjust the VRRP priority down if the WAN is not operational. Another example would be to probe the WAN interface of another VRRP router, and adjust the local VRRP priority up if that WAN interface is not operational. When configured to probe in this manner, it is necessary to configure a second Ethernet interface to be on the same subnet as the VRRP interface. This is because you cannot use the VRRP interface when it is in backup mode. The probes should be sent on this second interface. The second interface has the other VRRP router as its gateway. Configure the routing table to direct packets for the probe address to the desired interface.

every n seconds when in Backup state

The interval between successive probe attempts when the interface is in **Backup** state.

every n seconds when in Master state

The interval between successive probe attempts when the interface is in **Master** state.

Adjust priority n dir after x probe failures

Controls by how much and in which direction the VRRP priority is adjusted when the specified number of probes have failed.

Reset probe failure count after n probe successes

The number of consecutive successful probes required before the current failure count is reset to 0.

Use interface x,y over which to send probe

Overrides the routing code and forces the probe packets to be sent out of a specific interface.

Get the source IP address from interface x,y

Enables probe packets having the source IP address from a specific interface, rather than the interface over which it is being transmitted.

3. Click **Apply**.

**Command line**

Command	Instance	Parameter	Values	Equivalent web parameter
eth	n	vrrpid	0-255	VRRP Group ID
eth	n	vrrpprio	0-255	VRRP Priority
eth	n	vboostprio	0-255	Boost the priority by n for s seconds after switching to the MASTER state
eth	n	vboostsecs	Integer	Boost the priority by n for s seconds after switching to the MASTER state
eth	n	vprobemode	off, TCP, ICMP	Send p probe to IP address a.b.c.d TCP port n
eth	n	vprobeip	IP Address	Send p probe to IP address a.b.c.d TCP port n
eth	n	vprobeport	0-65535	Send p probe to IP address a.b.c.d TCP port n
eth	n	vprobackint	0-32767	every n seconds when in Backup state
eth	n	vprobemastint	0-32767	every n seconds when in Master state
eth	n	vprobeadj	0-255	Adjust priority n dir after x probe failures
eth	n	vprobeadjup	0=down 1=up	Adjust priority n dir after x probe failures
eth	n	vprobefailcnt	0-255	Adjust priority n dir after x probe failures

Command	Instance	Parameter	Values	Equivalent web parameter
eth	n	vprobesuccesscnt	0-255	Reset probe failure count after n probe successes
eth	n	vprobeent	Auto, ETH, PPP	Use interface x,y over which to send probe
eth	n	vprobeadd	Integer	Use interface x,y over which to send probe
eth	n	vprobeipent	Auto, ETH, PPP	Get the source IP address from interface x,y
eth	n	vprobeipadd	Integer	Get the source IP address from interface x,y

Configure logical Ethernet interfaces

Logical Ethernet interfaces are virtual Ethernet interfaces.

Logical Ethernet interfaces assign extra IP addresses to the router on the same or an alternate subnet using the same physical Ethernet connection.

You can use Logical Ethernet interfaces as a bridging feature, for example, in a Wi-Fi configuration, where it is desirable to not use a physical interface for the bridging.

You can configure them similarly to standard Ethernet interfaces, except for the **Speed** and **Duplex** settings, which require a physical interface.

Web

1. Go to **Configuration > Network > Interfaces > Ethernet > Logical Ethernet Interfaces**.

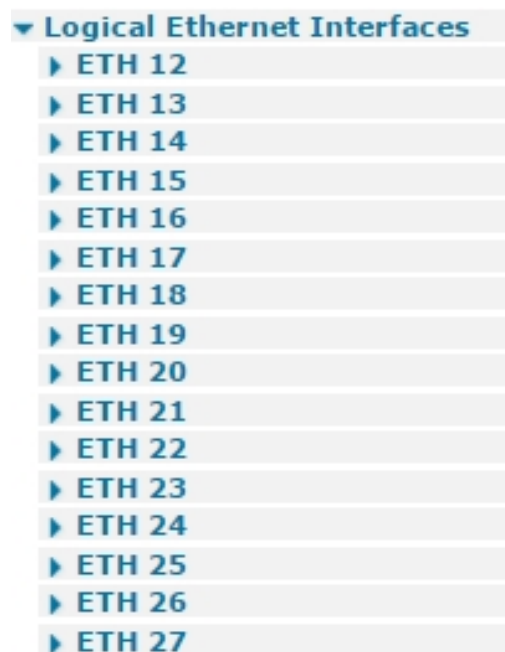

2. Configure the Ethernet settings as needed. For parameter descriptions, see [Configure basic Ethernet IP address parameters](#), [Configure advanced Ethernet parameters](#), [Configure Quality of Service \(QoS\)](#), and [Configure Ethernet Virtual Router Redundancy Protocol \(VRRP\)](#).
3. Click **Apply**.

Command line

Use the **eth** and **qos** commands to configure logical Ethernet interfaces, as documented in the Command line sections of these topics: [Configure basic Ethernet IP address parameters](#), [Configure advanced Ethernet parameters](#), [Configure Quality of Service \(QoS\)](#), and [Configure Ethernet Virtual Router Redundancy Protocol \(VRRP\)](#).

Configure which Ethernet devices can send packets to the router (MAC filtering)

Ethernet MAC filtering restricts which Ethernet devices can send packets to the router. If MAC filtering is enabled on an Ethernet interface, only Ethernet packets with a source MAC address that is configured in the MAC Filter table will be allowed. If the source MAC address is not in the MAC Filter table, the packet will be dropped.

Web

1. Go to **Configuration > Network > Interfaces > Ethernet > MAC Filtering**.
2. Configure MAC filtering settings:

Enable MAC filtering on Ethernet interfaces

Enables MAC filtering on a specific Ethernet interface.

▼ **MAC Filtering**

Caution: Carefully review settings before applying changes. Incorrect settings can make this router inaccessible from the network.

Enable MAC filtering on Ethernet interfaces

Interface	Enable
ETH 0	<input type="checkbox"/>
ETH 1	<input type="checkbox"/>
ETH 2	<input type="checkbox"/>
ETH 3	<input type="checkbox"/>
ETH 4	<input type="checkbox"/>
ETH 5	<input type="checkbox"/>
ETH 6	<input type="checkbox"/>
ETH 7	<input type="checkbox"/>
ETH 8	<input type="checkbox"/>

MAC Address

The Ethernet source MAC address to allow. It is possible to allow a range of MAC addresses by configuring only the significant part of the MAC address. such as **00:04:2d** will allow all Ethernet packets with a source MAC address starting with **00:04:2d**.

MAC Address

No MAC addresses have been added

3. Click **Apply**.

 **Command line**

Command	Instance	Parameter	Values	Equivalent web parameter
eth	n	macfilt	on, off	Enable MAC filtering on Ethernet interfaces
macfilt	n	mac	MAC address with no separators. Partial MAC address are allowed.	MAC Address

Configure an Ethernet bridge between two networks (MAC bridging)

The Ethernet MAC bridge function creates an Ethernet bridge between two physically separate Ethernet networks. It is possible to allow bridging over DSL, W-Wan, ISDN and PSTN connections but note that the only restriction on the traffic sent across the link is done via MAC address filtering and that all Ethernet traffic will be bridged, no firewall restrictions are applied to this traffic.

Once the bridge has been configured, the MAC addresses to bridge need to be configured in the MAC bridge table.

Web

1. Go to **Configuration > Network > Interfaces > Ethernet > MAC Filtering**.

▼ **MAC Bridging**

Enable MAC bridging on Ethernet interfaces

Interface	Enable	Forward to Host	Port	Listen on Port
ETH 0	<input type="checkbox"/>		0	0
ETH 1	<input type="checkbox"/>		0	0
ETH 2	<input type="checkbox"/>		0	0
ETH 3	<input type="checkbox"/>		0	0
ETH 4	<input type="checkbox"/>		0	0
ETH 5	<input type="checkbox"/>		0	0
ETH 6	<input type="checkbox"/>		0	0
ETH 7	<input type="checkbox"/>		0	0
ETH 8	<input type="checkbox"/>		0	0
ETH 9	<input type="checkbox"/>		0	0

2. Configure MAC bridging settings:

Enable

Enables MAC bridging on the Ethernet interface.

Forward to Host

The IP address of the remote router to which the Ethernet packets will be bridged.

Port

The TCP port that the remote router is listening on.

Listen on Port

The TCP port that the router will listen on for incoming bridged packet from the remote router.

MAC Address

The Ethernet destination MAC address of packets to be bridged. It is possible to allow a range of MAC addresses by configuring only the significant part of the MAC address. such as **00042d** will allow all Ethernet packets with a source MAC address starting with **00:04:2d**.

3. Click **Apply**.

 **Command line**

Command	Instance	Parameter	Values	Equivalent web parameter
eth	n	srcbhost	IP Address	Forward to IP address
eth	n	srchport	0-65535	Port
eth	n	srcblistenport	0-65535	Listen on Port
bridgemac	n	mac	MAC address with no separators. Partial MAC address are allowed.	MAC Address

Configure Rapid Spanning Tree Protocol (RSTP)

Note RSTP support is available on the WR44 family of devices only. It is not available on WR11, WR21, WR31, or WR41 devices.

The Rapid Spanning Tree Protocol (RSTP) is a Layer 2 protocol which ensures a loop free topology on a switched or bridged LAN while allowing redundant physical links between switches. When enabled, the TransPort device uses RSTP but this is backwards compatible with STP.

If the router is in **Port Isolate** mode, RSTP is not enabled. If an Ethernet interface is configured with a hub group, RSTP is disabled on that interface.

Web

Enable RSTP

Enables RSTP on the router.

Priority

The RSTP priority.

Group

The RSTP group that the router is in.

Command line

Command	Instance	Parameter	Values	Equivalent web parameter
stp	0	enable	on, off	Enable RSTP
stp	0	prio	0-65535	Priority
stp	0	group	-	Group
stp	0	debug	0, 1	Not available on the web interface.

View port status

To view the status of RSTP/STP on a router's Ethernet ports, use the following commands:

```
stp show
Port 0, Designated, Forwarding ctrl2:0x6
Port 1, Backup, Discarding ctrl2:0x1
Port 2, Backup, Discarding ctrl2:0x1
Port 3, Disabled, Discarding ctrl2:0x1
```

The port roles are:

Role	Description
Disabled	There is nothing physically connected to this Ethernet port.
Root	A forwarding port that has been elected for the spanning-tree topology, towards the root bridge.
Designated	A forwarding port for every LAN segment, away from the root bridge.
Alternate	An alternate path to the root bridge. This path is different than using the root port.
Backup	A backup/redundant path to a segment where another bridge port already connects.

The STP port states are:

State	Description
Disabled	The port is not functioning and cannot send or receive data.
Listening	The port is sending and receiving BPDUs and participates in the election process of the root bridge. Ethernet frames are discarded.
Learning	The port does not yet forward frames, but learns source addresses from frames received and adds them to the MAC address table.
Forwarding	The port receiving and sending data, normal operation. STP still monitors incoming BPDUs that would indicate it should return to the blocking state to prevent a loop.
Locking	A port that would cause a switching loop, no user data is sent or received but it may go into forwarding mode if the other links in use were to fail and the spanning tree algorithm determines the port may transition to the forwarding state. BPDU data is still received in blocking state.

The RSTP port states are:

Role	Description
Learning	The port does not yet forward frames but it does learn source addresses from frames received and adds them to the MAC address table. The port processes BPDUs.
Forwarding	The port receiving and sending data, normal operation. STP still monitors incoming BPDUs that would indicate it should return to the blocking state to prevent a loop.
Discarding	A port that would cause a switching loop, no user data is sent or received but it may go into forwarding mode if the other links in use were to fail and the spanning tree algorithm determines the port may transition to the forwarding state. BPDU data is still received in blocking state.

Configure Virtual LAN (VLAN) support

Virtual LANs (VLANs) allow splitting a single physical LAN into separate Virtual LANs. This is useful for security reasons, and also helps cut down on broadcast traffic on the LAN.

Web

1. Go to **Configuration > Network > Interfaces > Ethernet > VLANs**.

▼ VLANs

Enable VLAN support on Ethernet interfaces

Interface	Enable
ETH 0	<input type="checkbox"/>
ETH 1	<input type="checkbox"/>
ETH 2	<input type="checkbox"/>
ETH 3	<input type="checkbox"/>
ETH 4	<input type="checkbox"/>
ETH 5	<input type="checkbox"/>
ETH 6	<input type="checkbox"/>
ETH 7	<input type="checkbox"/>
ETH 8	<input type="checkbox"/>
ETH 9	<input type="checkbox"/>

2. Configure virtual LAN settings:

Enable VLAN support on Ethernet interfaces

This parameter enables VLAN support on the Ethernet interface.

VLAN ID

The ID of the Virtual LAN. The TCP header uses the VLAN ID to identify the destination VLAN for the packet.

You can configure up to 20 VLANs

VLAN ID	Ethernet Interface	IP Address	Mask	Source IP Address	Source mask
No VLAN configurations have been added					
<input type="text"/>	0 ▼	<input type="text"/>	<input type="text"/>	<input type="text"/>	<input type="text"/>

Add

Reserve VLAN ID for system usage

Apply

Ethernet Interface

The Ethernet port that tags the outgoing packets. Packets sent from this interface have VLAN tagging applied.

IP Address

The destination IP address. This parameter is optional. If configured, only packets destined for this IP address have VLAN tagging applied.

Mask

The destination IP subnet mask. This parameter is optional. If configured, only packets destined for this IP subnet mask have VLAN tagging applied.

Source IP Address

The source IP address. This parameter is optional. If configured, only packets from this IP address have VLAN tagging applied.

Source Mask

The source IP subnet mask. This parameter is optional. If configured, only packets from this IP subnet mask have VLAN tagging applied.

3. Click **Apply**.

**Command line**

Command	Instance	Parameter	Values	Equivalent web parameter
eth	n	vlan	on, off	Enable VLAN support on Ethernet interfaces
vlan	n	vlanid	0-4095	VLAN ID
vlan	n	ethctx	Integer	Ethernet Interface
vlan	n	ipaddr	IP Address	IP Address
vlan	n	mask	IP Mask	Mask
vlan	n	srcipaddr	IP Address	Source IP Address
vlan	n	srcmask	IP Mask	Source Mask

Configure Wi-Fi interfaces

The **Configuration > Network > Interfaces > Wi-Fi** section of the web interface that contains the configuration options required to configure and enable the Wi-Fi features.

Configure global Wi-Fi settings

Because of national restrictions on the channels available for use, the correct country should be selected from the drop down list to restrict the channels that are legal to use by the router. If required, a specific channel can be selected to override the auto selection. The **Antenna** setting is not available on some but not all TransPort WR routers.

Web

1. Go to **Configuration > Network > Interfaces > Wi-Fi > Global Wi-Fi Settings**.

[Configuration - Network > Interfaces > Wi-Fi > Global Wi-Fi Settings](#)

▼ Interfaces

- ▶ Ethernet
- ▼ Wi-Fi
 - ▼ Global Wi-Fi Settings

Country:

Remote management access:

Network Mode:

Channel:

Antenna:

▶ Advanced

▶ Wi-Fi Hotspot

▶ Wi-Fi Filtering

2. Configure global Wi-Fi settings:

Country

Selecting a country from the drop down list restricts the channels that the router will use. See for more info on licensed channels.

Network Mode

Select your chosen mode of operation from the drop down list. The available options vary by router, and some operation modes may not be available on some models.

Channel

Selecting **Auto** allows the router to scan for a free channel within the range of legal channels for the selected country. It is possible to manually select a specific channel to use, but make sure the selected channel is legal to use in the country.

3. Click **Apply**.



Command line

Command	Instance	Parameter	Values	Equivalent web parameter
wifi	0	country	Country name	Country
wifi	0	chanmode	a, an, anac, bg, bgn	Network Mode
wifi	0	channel	auto, 1-14, 36, 40, 44, 48, 56, 60, 64, 149, 153, 155, 157, 161, 165	Channel
wifi	0	nocfg	0 - No restrictions 1 - Disable management 2 - Disable return RST 3 - Disable management and return RST	Remote Management access
wifi	0	antenna	0 - Auto 1 - Primary 2 - Secondary	Antenna

Restricting Wi-Fi channels by country

The web interface Country setting and CLI wifi country parameter allow specifying a country name to restrict the number of channels the router uses according to the channels supported in a particular country. Following is a list of the countries that are currently supported:

Albania	Guatemala	Oman
Algeria	Honduras	Pakistan
Argentina	Hong Kong	Panama
Armenia	Hungary	Paraguay
Australia	Iceland	Peru
Austria	India	Philippines
Azerbaijan	Indonesia	Poland
Bahrain	Iran	Portugal
Belarus	Iraq	Puerto Rico
Belgium	Ireland	Qatar
Belize	Israel	Romania
Bolivia	Italy	Russia
Brazil	Jamaica	Saudi Arabia
Brunei	Japan	Singapore
Bulgaria	Jordan	Slovak Republic
Canada	Kazakhstan	Slovenia
Chile	Kenya	South Africa
China	North Korea	Spain
Colombia	South Korea	Sweden
Costa Rica	Kuwait	Switzerland
Croatia	Latvia	Syria
Cyprus	Lebanon	Taiwan
Czech Republic	Libya	Thailand
Denmark	Liechtenstein	Trinidad and Tobago
Dominican Republic	Lithuania	Tunisia
Ecuador	Luxembourg	Turkey
Egypt	Macau	U.A.E.
El Salvador	Macedonia	Ukraine
Estonia	Malaysia	United Kingdom
Faroe Islands	Mexico	United States
Finland	Monaco	Uruguay
France	Morocco	Uzbekistan
Georgia	Netherlands	Venezuela
Germany	New Zealand	Vietnam
Greece	Nicaragua	Yemen
	Norway	Zimbabwe

Licensed channels when channel number is set to Auto

When the channel number is **Auto**, the licensed channels the router uses are:

Region	2.4 GHz channels	5 GHz channels
EMEA (excluding France)	1-13	36, 40, 44, 48
France	10-13	36, 40, 44, 48
Americas (excluding Mexico)	1-11	36, 40, 44, 48, 149, 153, 157, 161, 165
Mexico	1-8 Indoor, 9-11 outdoor	36, 40, 44, 48, 149, 153, 157, 161, 165
Israel	3-9	36, 40, 44, 48, 149, 153, 157, 161, 165
China	1-11	149, 153, 157, 161, 165
Japan	1-14	36, 40, 44, 48

Note It is **illegal** to use restricted channels in certain countries.

Configure advanced global Wi-Fi settings

The Advanced Global Wi-Fi settings control the behavior of the protocols used in Wi-Fi communications at a more detailed level.

Web

1. Go to **Configuration > Network > Interfaces > Wi-Fi > Global Wi-Fi Settings > Advanced**.
2. Configure advanced global Wi-Fi settings as needed:

EAP Timeout

An inactivity timeout during enterprise mode authentication. This parameter is used when the device is configured as an Access Point.

EAP Identity Request Timeout

When the device is configured as an Access Point, this parameter sets the time the device waits after sending an ID request to the Wi-Fi client.

Noise floor offset

This parameter applies to TransPort WR44v2 models with a Wi-Fi **a/b/g/n** module only. Normally, users do not need to change this parameter.

An offset, specified in dBm, that is added to the noise floor calculated by the Wi-Fi module and used in clear-channel assessment when frames are transmitted, and in determining the signal strength of clients. Using this parameter can address problems in noisy environments where the Wi-Fi module may calculate the noise floor as too low, which can result in a breakdown in Wi-Fi communications. Note, however, that a higher noise floor offset value can result in decreased sensitivity (range).



CAUTION! Changing this value from its default of **0 dBm** can severely impact device performance. Change this setting only under the direction of Digi Technical Support.

3. Click **Apply**.

Command line

Command	Instance	Parameter	Values	Equivalent web parameter
wifi	0	eapto	<seconds>; default is 30 seconds	EAP Timeout
wifi	0	eapidreqto	<seconds>; default is 30 seconds	EAP Identity Request Timeout
wifi	0	noise_floor_offset	<integer value>	Noise floor offset

Configure a Wi-Fi node as a hotspot

The Wi-Fi Hotspot settings apply to using any Wi-Fi node as a hotspot.

Web

1. Go to **Configuration > Network > Interfaces > Wi-Fi > Global Wi-Fi Settings > Wi-Fi Hotspot**.
2. Configure Wi-Fi hotspot settings:

Enable Wi-Fi Hotspot on

Enables or disables Wi-Fi Hotspot support on a particular Wi-Fi node.

Splashscreen filename

Selects an ASP web file that will be presented to the client’s internet browser when they connect for the first time.

Each client can connect for h hrs m mins

The amount of time that a Wi-Fi client can use the Wi-Fi hotspot before having to re-authenticate.

Require Wi-Fi client authentication

If enabled, specifies that Wi-Fi hotspot authentication is required for Wi-Fi clients. You can then select the RADIUS configuration to use.

Hotspot Exceptions

It is possible to configure a number of web locations for which authentication is not required. These settings allow the splashscreen to access these locations in order to display them to the client when authenticating.

3. Click **Apply**.

Command line

Command	Instance	Parameter	Values	Equivalent web parameter
wifinode	n	hotspot	on, off	Enable Wi-Fi Hotspot on
wifi	0	hotspot_fname	Filename	Splashscreen filename
wifi	0	hotspot_lifetime	Integer	Each client can connect for h hrs m mins. The CLI value is entered in seconds only.
wifi	0	hotspot_auth	on, off	Require Wi-Fi client authentication
wifi	0	hotspot_radiuscfg	0, 1	Use RADIUS instance
hshosts	n	host	Hostname	Hotspot Exceptions

Configure Wi-Fi filtering

You can restrict access to the router via Wi-Fi. When the filtering is enabled, only MAC addresses configured in the table will be allowed to connect to the router.

Web

1. Go to **Configuration > Network > Interfaces > Wi-Fi > Global Wi-Fi Settings > Wi-Fi Filtering**.
2. Configure Wi-Fi filtering settings:

Enable Wi-Fi filtering

Enable Wi-Fi filtering so that only clients who have their Wi-Fi MAC address configured in the MAC address table will be allowed to connect.

MAC Address

MAC addresses of Wi-Fi client that you wish to allow access to.

A valid MAC address has the format: **11:22:33:44:55:66**. When entering this parameter, omit the : separators. For example, **112233445566**.

Note Carefully review settings before applying changes. Incorrect settings can make the TransPort device inaccessible from the Wi-Fi network.

3. Click **Apply**.

Command line

Command	Instance	Parameter	Values	Equivalent web parameter
wifinode	n	macfilter	on, off	Enable Wi-Fi filtering
wifi	0	mac	MAC address with no separators, such as 112233445566	MAC Address

Configure a Wi-Fi node

When a Wi-Fi interface is configured to be an Access Point, an SSID must be configured for a Wi-Fi interface to operate.

To forward packets to and from a Wi-Fi interface, the Wi-Fi interface must be bridged to a configured Ethernet interface. The Wi-Fi interface and Ethernet interface must be in the same Bridge instance.

If a DHCP server is required to run on the Wi-Fi interface, the DHCP server instance corresponding bridged Ethernet interface should be configured.

In some cases, it may be necessary to bridge multiple Ethernet instances to a single Wi-Fi instance. If this is required, only one Ethernet instance should be configured.

Web

1. Go to **Configuration > Network > Interfaces > Wi-Fi > Wi-Fi Node n**.
2. Configure the Wi-Fi node settings:

Enable this Wi-Fi interface

Enables or disables the Wi-Fi interface.

Description

A descriptive name for the Wi-Fi interface to make it easier to identify.

SSID

When the Wi-Fi interface is configured to be an Access Point, this is the SSID that is advertised to the Wi-Fi clients.

When the Wi-Fi interface is configured to be a Client, this is the SSID of the Access Point to which you wish to connect.

Mode

The Wi-Fi interface can run in various modes. The options are:

- Access Point
- Client

Rogue Detection (Scan for unauthorised Access Points)

This Wi-Fi interface is a member of Bridge instance **n** and therefore bridged to the following interfaces. The options are:

- Access Point. When the Wi-Fi interface is configured to be an Access Point, to forward packets to and from the Wi-Fi interface, it must be bridged with an Ethernet interface using a Bridge instance.
- Client

Interface

Interfaces that are currently members of the selected Bridge instance. Note that multiple Wi-Fi interfaces can be members of the same Bridge instance.

Link this Wi-Fi client interface with Ethernet n

When the Wi-Fi interface is configured to be a client, it must be bridged to a particular Ethernet interface.

This Wi-Fi rogue scanner will use Ethernet n

When the Wi-Fi interface is configured to be a rogue scanner, it uses the selected Ethernet interface.

Hide SSID

When enabled, the SSID is not included in the beacon messages transmitted by the Wi-Fi interface when in Access Point mode. This means that Wi-Fi clients cannot auto-detect the Access Point.

Enable station isolation

When enabled, connected Wi-Fi clients cannot communicate with other Wi-Fi clients or Ethernet hosts connected to this Access Point.

Click here to assign a timeband to this interface

You can optionally assign a time band to the Wi-Fi interface. Time bands determine periods of time during which the router allows activating PPP or Wi-Fi interfaces or prevents them from activating. The **Configuration > Network > Timebands** page opens with a list of interfaces. Go to the Wi-Fi interface list and enable time bands as desired. See [Configure a time band](#) for more information.

3. In the **Security** section, configure Wi-Fi security for the node:

If you are using multiple Wi-Fi interfaces at the same time, the interfaces must use the same security settings, except for the pre-shared key (PSK). The only alternative is to use Wi-Fi with no security.

Use the following security on this Wi-Fi interface

Selects the security on this Wi-Fi interface. The options are:

- None
- WEP
- WPA-Personal
- WPA2-Personal
- WPA-Enterprise
- WPA2-Enterprise

WEP Settings

The various WEP security settings for both Access Point and Client modes.

WEP Key size

The WEP key size to use.

WEP Key index

The WEP key index number. This needs to match the index selected on the connecting Wi-Fi clients or Access Points that this router wishes to connect to.

WEP Key / Confirm WEP Key

If the WEP key size is 64 bits, the key should be 5 characters long. If the WEP key size is 128 bits, the key should be 13 characters long.

WPA-PSK / WPA2-PSK

The various WPA-PSK / WPA2-PSK security settings for both Access Point and Client modes.

WPA Encryption

The encryption algorithm to use. The options are:

- TKIP
- AES (CCMP)

WPA pre-shared key / Confirm WPA pre-shared key

The pre-shared key (PSK) to use. It must be between **8** and **63** characters long.

WPA-RADIUS / WPA2-RADIUS

The various WPA-RADIUS / WPA2- RADIUS security settings for both Access Point and Client modes.

WPA Encryption

The encryption algorithm to use. The options are:

- TKIP
- AES (CCMP)

RADIUS NAS ID

The NAS ID of the RADIUS server.

RADIUS Server IP Address

The IP address of the RADIUS server

RADIUS Server Password / Confirm RADIUS Server Password

The password of the RADIUS server.

- To connect the Wi-Fi node to an existing Wi-Fi Access Point, click **Network Scanning** and click **Perform Network Scan**. The router scans the local airwaves for any Access Points that are present, and lists the results in a table:

▼ **Wi-Fi Node 0**

▼ **Network Scanning**

Perform Network Scan

Wireless Networks						
SSID	MAC	Security	WPA Type	Signal	Channel	
NISBET	00:14:78:D9:84:44	WPA2 Personal	AES	good	1	Connect
wu24hz	60:E7:01:C4:28:B0	WPA2 Personal	AES	good	1	Connect
NISBET	A0:F3:C1:E4:9F:89	WPA2 Personal	AES	good	6	Connect
NISBET	00:18:E7:FC:AD:EC	WPA2 Personal	AES	excellent	12	Connect

Finished Network Scan.

Click **Connect** to connect to one of the Access Points.

- Click **Apply**.

Command line

Basic Wi-Fi node settings

Command	Instance	Parameter	Values	Equivalent web parameter
wifinode	0	enabled	on, off	Enable this Wi-Fi interface
wifinode	0	descr	String	Description
wifinode	0	ssid	String up to 32 characters	SSID
wifinode	0	mode	ap, client, rogue	Mode
wifinode	o	bridge_inst	0-3	This Wi-Fi interface is a member of Bridge instance n and therefore bridged to the following interfaces
eth	n	bridge_inst	0-3	Interface
eth	n	wificli	on, off	Link this Wi-Fi client interface with Ethernet n
eth	n	wificli_add	Integer	Link this Wi-Fi client interface with Ethernet n
wifinode	0	broadcastssid	on, off	Hide SSID
wifinode	0	isolation	on, off	Enable station isolation
wifinode	n	roam_threshold	RSSI value	None; command-line only
wifinode	n	roam_timeout	Seconds	None; command-line only

Note The **roam_threshold** and **roam_timeout** parameters can impact monitoring. If **roam_threshold** and **roam_timeout** are both non-zero, and the Wi-Fi node is configured in client mode, monitoring of the signal strength of the link to the currently associated Access Point starts as soon as the client has successfully connected to that Access Point. Signal strength monitoring stops at any time the client disconnects from the Access Point. If the RSSI of frames received from the Access Point stays below the **roam_threshold** for **roam_timeout** consecutive seconds, monitoring stops and the client starts scanning for Access Points.

Wi-Fi node security settings

Command	Instance	Parameter	Values	Equivalent web parameter
wifinode	0	security	none wep wpapsk wpa2psk wparadius wpa2radius	Use the following security on this Wi-Fi interface
wifinode	0	weptype	open, sharedkey	Not available on the WEB.
wifinode	0	wepkeylen	64, 128	WEP Key size
wifinode	0	wepkeyindex	1-4	WEP Key index
wifinode	0	wpatype	tkip, aes	WPA Encryption
wifinode	0	sharedkey	text	WEP Key/WPA pre-shared key
radcli	n*	nasid	String	RADIUS NAS ID
radcli	n*	server	IP Address	RADIUS Server IP Address
radcli	n*	password	String	RADIUS Server Password

* The Wi-Fi interfaces each use a fixed RADIUS client. For example:

- Wi-Fi 0 uses **radcli 1**
- Wi-Fi 1 uses **radcli 2**
- Wi-Fi 2 uses **radcli 3**, and so on.

The following table details the authentication and encryption algorithms and the CLI commands needed to configure them.

Network Authentication	Data Encryption	CLI Commands
Open	Disabled	wifinode 0 security none
Shared	Disabled	Not supported

Network Authentication	Data Encryption	CLI Commands
Open	WEP	wifinode 0 security wep wifinode 0 weptype open wifinode 0 wepkeylen <64 128> wifinode 0 wepkeyindex <1..4> wifinode 0 sharedkey <5 or 13 char key>
Shared	WEP	wifinode 0 security wep wifinode 0 weptype sharedkey wifinode 0 wepkeylen <64 128> wifinode 0 wepkeyindex <1..4> wifinode 0 sharedkey <5 or 13 char key>
WPA	TKIP	wifinode 0 security wparadius wifinode 0 wptype tkip wifinode 0 radiuscfg 1
WPA2	TKIP	wifinode 0 security wpa2radius wifinode 0 wptype tkip wifinode 0 radiuscfg 1
WPA-PSK	TKIP	wifinode 0 security wpapsk wifinode 0 wptype tkip wifinode 0 sharedkey <8..63 char key>
WPA2-PSK	TKIP	wifinode 0 security wpa2psk wifinode 0 wptype tkip wifinode 0 sharedkey <8..63 char key>
WPA	AES	wifinode 0 security wparadius wifinode 0 wptype aes wifinode 0 radiuscfg 1
WPA2	AES	wifinode 0 security wpa2radius wifinode 0 wptype aes wifinode 0 radiuscfg 1
WPA-PSK	AES	wifinode 0 security wpapsk wifinode 0 wptype aes wifinode 0 sharedkey <8..63 char key>
WPA2-PSK	AES	wifinode 0 security wpa2psk wifinode 0 wptype aes wifinode 0 sharedkey <8..63 char key>

Perform a rogue scan

Wi-Fi-equipped TransPort routers can perform a rogue scan to scan the Wi-Fi channels and will which Wi-Fi Access Points it detects. You can use rogue scans to detect unauthorized Access Points that might be trying to get unsuspecting Wi-Fi clients to connect them. When the router detects an authorized Access Point, the router creates an event log entry. In addition, you can configure triggering an alarm notification, such as email, SMS message, or SNMP trap. From the rogue scan results, you can save a list a list of the MAC addresses of the authorized Access Points that will not be reported when detected.

Web

1. Go to **Configuration > Network > Interfaces > Wi-Fi > Rogue Scan**.

▼ Rogue Scan

Do not flag as rogue the following APNs
(you may specify up to 4 addresses).

A valid MAC address has the format 11:22:33:44:55:66
(a hyphen '-' is also accepted as the separator).

MAC Address
No MAC addresses have been added

2. In the **MAC Address** field, enter The MAC address of an authorized Access Point
3. Click **Add** to add the authorized Access Point to the list of authorized Access Points.
4. Click **Perform Rogue Scan**. The router scans the Wi-Fi channels to detect unauthorized Access Points.
5. Click **Apply**.

Command line

Command	Instance	Parameter	Values	Equivalent web parameter
macrogue	n	mac	MAC address with no separators, for example 112233445566	MAC Address

Configure mobile (cellular) interfaces

Configuration parameters required from your mobile network

Before attempting to connect to a wireless service, you must set several parameters specific to your mobile network operator. Have the following information on hand:

- The assigned APN (Access Point Name), unless the router is configured to select the APN automatically.
For more information about automatic APN selection, see [Automatic APN configuration](#).
- PIN Number for your SIM card (if any)
- Username and password (if any)

Supported cellular modules in Digi TransPort products

For the TransPort product family, Digi continues to add support for cellular modules as vendors make updates and improvements to support the latest chipsets and cellular technology. Digi provides the following support and testing for cellular modules:

- Full support for cellular modules currently shipping in Digi products. Digi verifies that these modules are running the latest module firmware, that this latest firmware is compatible and functions properly.
- Partial support for cellular modules that have shipped in Digi TransPort products previously but are no longer actively supported by the module vendor. Firmware testing no longer includes these modules, however every attempt is made to maintain support as features and improvements are implemented. Any issues with these modules that arise are verified, scoped, and either scheduled to be fixed or a newer, supported module offered as an upgrade option.
- Limited support for cellular modules that have never shipped in Digi TransPort products, and have never been part of firmware testing and verification efforts. These modules may be similar to fully- or partially-supported modules by the same vendor and may even have been informally tested and shown to work in Digi products. Any operational and performance issues with these modules are evaluated and scoped to be fixed on a business case basis.

For the current list of cellular modules for which Digi provides full, partial, and limited support, see the Release Notes for the most recent Digi TransPort firmware. The release notes are available on the Product Support page for your Digi TransPort product, under **General Firmware**.

Configure SIMs

1. Go to **Configuration > Network > Interfaces > Mobile**. At the top of the **Mobile** settings are several settings for configuring the SIM or SIMs for the cellular service.

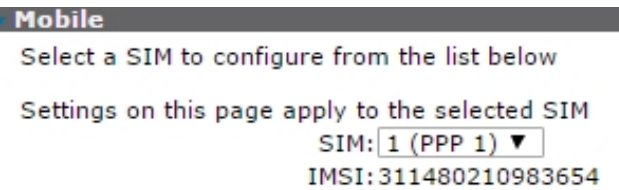

2. Select a SIM to configure. **SIM 1** specifies the SIM card fitted to the slot marked **SIM 1** in the router's SIM card slots. **SIM 2** specifies the SIM card fitted to the slot marked **SIM 2**.

Note When using a single SIM card, the default action is for the router to use **PPP 1** as the mobile interface. To configure dual SIMs for fail-over, go to **Configuration > Network > Interfaces > Mobile > SIM Selection** to launch the Dual SIM wizard. See [Configure SIM failover](#).

Configure mobile connection settings

Select the service plan and connection settings for connecting to the mobile network.

Web

1. Go to **Configuration > Network > Interfaces > Mobile > Mobile Settings**. The **Mobile Settings** page has several groups of settings. These settings vary depending on the cellular module in your router.
2. Configure the mobile service provider settings:

Mobile Settings
Select the service plan and connection settings used in connecting to the mobile network.

Mobile Service Provider Settings

Service Plan / APN:

Select APN automatically

Use backup APN Retry the main APN after minutes

SIM PIN: (Optional)

Confirm SIM PIN:

Username: (Optional)

Password: (Optional)

Confirm Password:

Service Plan / APN

Enter an Access Point Name (APN) to overwrite the built-in default.

Select APN automatically

Only available for routers with one of the following module types:

- SIERRA_LTE
- TELIT_LTE_V2

For more information, see [Automatic APN configuration](#).

SIM PIN (optional)

Some SIM cards are locked with a Personal Identification Number (PIN) code to prevent misuse if they are lost or stolen. The cellular service provider should be able to confirm if the SIM requires a PIN code. If you enter a PIN code in this field, the router will try to unlock the SIM before attempting to connect to the network.

Confirm SIM PIN

Enter the PIN again in this field to confirm it.

Mobile Connection Settings

- Re-establish connection when no data is received for a period of time
- Inactivity Timeout: hrs mins seconds

Re-establish connection when no data is received for a period of time.

Sets up an inactivity timer to trigger a reconnection when no packets are received for a period of time.

Inactivity Timeout: h hrs m mins s seconds

The amount of time the router waits without receiving any PPP packets before disconnecting. This inactivity timeout is reset with each received PPP packet.

5. Configure the mobile network settings:

Mobile Network Settings

- Enable NAT on this interface**
 - IP address IP address and Port
- Enable IPsec on this interface**
 - Keep Security Associations (SAs) when this Mobile interface is disconnected**
 - Use interface for the source IP address of IPsec packets
- Enable the firewall on this interface**

Enable NAT on this interface

Enables or disables IP Network Address Translation (NAT) on the mobile interface. When enabled, displays the following options:-

IP Address

Enables standard Network Address Translation (NAT).

IP address and Port

Enables Network Address and Port Translation (NAPT).

Enable IPsec on this interface

Enables or disables IPSec processing on the mobile interface. If enabled, packets sent or received on this interface must pass through the IPSec code before being transmitted. IPSec may drop the packet, pass it unchanged, or encrypt and encapsulate within an IPSec packet. When enabled, displays the following parameters:-

Keep Security Associations (SAs) when this Mobile interface is disconnected

Configures the router to keep any existing IKE and IPSec associations should the link drop. This is usually applied on head-end routers with fixed IP addresses.

Use interface X, Y for the source IP address of IPsec packets

By default, the source IP address for an IPSec route will be the IP address of the interface on which IPSec was enabled. By setting this parameter to either a PPP or Ethernet interface, the source IP address IPSec uses will match that of the Ethernet or PPP interface specified.

Enable the firewall on this interface

Enables or disables the firewall script processing for the mobile interface.

Note If the firewall is enabled on an interface and with the absence of any firewall rules, the default action is to block ALL traffic.

6. Click **Apply**.

 **Command line**
Configure mobile service provider settings commands for SIM 1 (PPP 1)

Command	Instance	Parameter	Values	Equivalent web parameter
modemcc	0	apn	Free text field	Service Plan / APN:
modemcc	0	autoapn	on/off	Checkbox (Select APN automatically)
modemcc	0	usebuapn	on/off	Checkbox (Use Backup APN)
modemcc	0	buapn	Free text field	Use backup APN
modemcc	0	pin	SIM PIN number	SIM PIN:/Confirm SIM PIN
ppp	1	username	Free text field	Username:
ppp	1	password	Free text field	Password:/Confirm Password

Configure mobile service provider settings commands for SIM 2 (PPP 1)

Command	Instance	Parameter	Values	Equivalent web parameter
modemcc	0	Apn_2	Free text field	Service Plan / APN:
modemcc	0	autoapn_2	on/off	Checkbox (Select APN automatically)
modemcc	0	Usebuapn_2	on/off	Checkbox (Use Backup APN)
modemcc	0	Buapn_2	Free text field	Use backup APN
modemcc	0	Pin_2	SIM PIN number	SIM PIN:/Confirm SIM PIN
ppp	1	username	Free text field	Username:
ppp	1	password	Free text field	Password:/Confirm Password

Configure mobile connection settings

Command	Instance	Parameter	Values	Equivalent web parameter
ppp	n	rxtimeout	off, on	Re-establish connection when no data is received for a period of time.
ppp	1	rxtimeout	0-86400 (seconds)	Inactivity Timeout: h hrs m mins s seconds

Configure mobile network settings

Command	Instance	Parameter	Values	Equivalent web parameter
ppp	1	do_nat	1	Enable NAT on this interface IP Address
ppp	1	do_nat	2	Enable NAT on this interface IP Address and Port
ppp	1	ipsec	1	Enable IPsec on this interface
ppp	1	ipsec	2	Keep Security Associations (SAs) when this Mobile interface is disconnected
ppp	1	ipsecent	blank,ETH,PPP	Use interface X, Y for the source IP address of IPsec packets x=Interface type
ppp	1	ipsecadd	0-255	Use interface X, Y for the source IP address of IPsec packets y=interface number
ppp	1	firewall	off, on	Enable the firewall on this interface

Automatic APN configuration

Certain variants of Digi TransPort routers include support for automatically configuring an Access Point Name (APN). This functionality is only available for routers with the following cellular module types:

- SIERRA_LTE
- TELIT_LTE_V2

Automatic APN configuration is enabled on these routers only when **Select APN automatically** is enabled and **Service Plan / APN** is empty. These can also be set at the command line with the modemcc command:

```
modemcc 0 autoapn on
modemcc 0 apn none
```

To configure the APN, the router uses an IMSI to APN assignments file, **imsi.txt**. The **imsi.txt** file maps ICCID and IMSI prefixes to APN values. For more information about updating and editing the **imsi.txt** file, see [imsi.txt](#).

Getting Started Wizard

Automatic APN selection is initially configured in the **Getting Started Wizard** on the Cellular connectivity page, by using the **Allow automatic APN detection?** option. If the router detects a supported cellular module and can determine the APN, this option will default to **Yes**. This will set the APN name to **None**, which allows the router to automatically detect the name.

Web UI

The **Mobile Settings** page of the Web UI (**Configuration > Network > Interfaces > Mobile > Mobile Settings**) includes the **Select APN automatically** checkbox. This checkbox is automatically enabled if APN detection was enabled in the **Getting Started Wizard**.

If automatic APN selection is enabled in either the **Getting Started Wizard** or the **Web UI**, but the router cannot determine the APN, the APN will be set to **None**.

imsi.txt

Digi TransPort routers that support the automatic assignment of APNs use a text file, **imsi.txt**, to configure APNs. The TransPort device compares the IMSI and ICCID values read from the modem with the prefixes in the entries in **imsi.txt**, and will use the APN associated with the first match found in **imsi.txt** to configure the APN for the selected SIM. If no match is found, the APN will be left unchanged.

The **imsi.txt** file may be periodically updated by Digi personnel, and can be updated as part of the standard carrier firmware update procedures. For more information about updating your carrier firmware, see [Update carrier firmware](#). You can also edit the **imsi.txt** to include additional ICCID and IMSI prefixes and corollary APNs. To edit the **imsi.txt** file:

1. Open the file in the File Editor (**Administration > File Management > File Editor**). See [Manage files](#) for further information.
2. For the Filename field, select **imsi.txt**.

The file format used by the **imsi.txt** consists of three comma and space separated elements: the ICCID Fragment, the IMSI fragment, and the APN:

```

891223, 3022205370, m2mjde.telus.com # IMSI 3022205370****
891223, 3022205371, m2m-east.telus.iot # IMSI 3022205371****
891223, 3022205372, m2m-east.telus.iot # IMSI 3022205372****

```

3. Add additional ICCID and IMSI fragments and APNs as necessary, using this format.

Note If there are multiple occurrences of the same ICCID and IMSI fragments, the device will use the APN associated with first occurrence of the ICCID and IMSI fragments in the file.

4. Click **Save file**.

Configure SIM failover

For TransPort routers equipped with dual SIMs, you can configure the router to fail over from one SIM to another.

A SIM failover configuration will failover to a temporary “on demand” cellular connection using the second SIM card. When the second SIM card is in use, after a specified period of inactivity or after a maximum amount of time has been reached or the inactivity timeout is reached, the backup link will deactivate and the TransPort will attempt to use the first SIM card again. This method is useful when it is not desirable to use the second SIM card indefinitely, for example, if some functionality is lost or the data charges are higher.

Web

1. Go to **Configuration > Network > Interfaces > Mobile > SIM Selection**. You can also launch the SIM selection wizard from **Wizards > Dual SIM wizard > Next**.
2. Click the link text **here** to launch the Dual SIM wizard.
3. Follow the prompts of the wizard.

The wizard configures the basic failover SIM failover settings. You may need to perform additional configuration after the wizard completes. See these application notes for more information:

- [Application Note 14: Configure a Dual SIM cellular router to automatically failover to a second SIM card and revert back to the original SIM after a specified amount of time](#)
- [Application Note 15: Configure a Dual SIM cellular router to automatically failover to the second SIM card and remain on SIM 2 until a failure is detected, then revert to SIM 1](#)

Configure advanced mobile parameters

It is recommended that you have the advanced mobile settings remain at their defaults.

Web

1. Go to **Configuration > Interfaces > Mobile > Advanced**.

▼ **Advanced**

SIM PUK: (Optional)
 Confirm SIM PUK:

Initialisation string 1:
 Initialisation string 2:
 Initialisation string 3:
 Hang-up string:
 Post hang-up string:

Wait seconds between hanging up and allowing another call
 Wait seconds between attachment attempts

Reset the module after unsuccessful connection attempts
 Reset the module after unsuccessful status retrieval attempts

Create a signal strength event every minutes

If registration is lost for 5 minutes

2. Enter the advanced mobile parameters:

SIM PUK

(Optional) If known, the SIM PUK code can be entered in these fields. If the router detects that a PUK is required due to a locked SIM, this number will be sent to the SIM. A SIM PIN must also be configured for the PUK parameter to take effect.

Confirm SIM PUK

Enter the PUK code again in this field to confirm it.

Initialisation string <n>

These parameters (**Initialisation string 1**, **Initialisation string 2**, **Initialisation string 3**) specify a number of command strings that are sent to the wireless module each time a wireless connection is attempted. You can use these parameters to set non-standard wireless operating modes.

Before being sent to the wireless module, each string is prefixed with the characters AT, then sent to the wireless module in the order specified until an empty string is encountered. For example, Initialisation string 3 is not sent unless Initialisation string 1 and Initialisation string 2 are both specified. Initialisation strings are not normally required for most applications as the router will normally be preconfigured for correct operation with most networks.

Hang-up string

In a typical wireless application, the connection to the network is always on and under normal circumstances it is not necessary to hang-up the wireless module. Under certain circumstances however, the router may use the ATH command to try and disconnect the wireless module from the network, such as if an incorrect APN has been specified and the module is unable to attach to the network correctly.

This parameter specifies an alternative hang-up string that is sent to the wireless module when disconnecting a call. As with the Initialisation strings, it is not necessary to include the AT as this is inserted automatically by the router

Post Hang-up string

Additional AT commands that are sent to the wireless module after it has been disconnected. As with the Initialisation strings, it is not necessary to include the AT as this is inserted automatically by the router.

Wait n seconds between hanging up and allowing another call

The length of time, in seconds, that the router will wait after hanging up the wireless module before initiating another call attempt.

Wait n seconds between attachment attempts

The number of seconds between network attachment attempts, some networks require 60 seconds between attempts to attach to the wireless network.

Reset the module after n unsuccessful connection attempts

The router will normally make multiple attempts to connect to the wireless network in the event that the signal is lost. In some cases, this can result in a lock-up situation where the wireless network is unable to attach the wireless device due to the multiple attempts. This parameter specifies the number of attempts at connection that the router should make before power cycling the internal wireless module. Power cycling the wireless module forces it to re-register and reattach to the network. The default value varies depending on the router's cellular module. Using the default value is recommended. Setting this parameter to **0** prevents the router from power-cycling the wireless module if it cannot obtain an IP address.

Reset the module after n unsuccessful status retrieval attempts

The router periodically collects status information from the internal wireless module. This information, which may be viewed on the **Management > Network Status > Interfaces > Mobile** web page, includes details of the signal strength and network attachment status. As a safeguard against problems communicating with the wireless module, you can use the status retries parameter to specify the number of unsuccessful attempts to retrieve status information from the wireless module before power cycling it. The default setting of **30** is the recommended value. Setting this parameter to **0** prevents the router from power-cycling the wireless module if it cannot read the wireless status information.

Create a signal strength event every n minutes

Configures the router to write the signal strength to the Event Log every **n** minutes.

If registration is lost for 5 minutes

Controls whether the router will power cycle the wireless module after the network registration has been lost for **5** minutes. Setting this parameter to **do not reset the module** will never recycle the wireless module, setting to **reset the module if GSM registration is**

lost will power cycle the module after **5** minutes loss of GSM registration, and setting to **reset the module if GPRS registration is lost** will power cycle the module after **5** minutes loss of GPRS, 4G/LTE, 3G, or HSPA registration.

Preferred System

Controls which mobile technology is the preferred system (**2G/3G**).

- When set to **Auto**, the cellular module chooses the fastest technology available.
- When set to **GSM**, the cellular module tries GSM (GPRS/EDGE) technology first.
- When set to **WCDMA**, the cellular module tries WCDMA (UMTS/HSPA) technology first.
For CDMA: select **CDMA for 2G (1xRTT)** or **EVDO for 3G**.
- When set to **4G/LTE**, the cellular module tries 4G/LTE technology first.

3. In the **Mobile Network Settings** section, enter the mobile network settings.:

Mobile Network Settings

Metric:

Generate Heartbeats on this interface

Send Heartbeat messages to IP address every hrs mins secs

Use interface for the source IP address

Select transmit interface using the routing table

Include IMSI information in the Heartbeat message

Include GPS information in the Heartbeat message

Generate Ping packets on this interface

Metric

The connected metric of the mobile interface. The default metric of a connected interface is **1**. By allowing the interface to have a higher value (lower priority), static routes can take preference to interfaces. For normal operation, leave this value unchanged.

Generate Heartbeats on this interface

Heartbeat packets are UDP packets that contain status information about the router that you can use to locate a remote unit's current dynamic IP address. When enabled, displays the following parameters:

Send Heartbeat messages to IP address a.b.c.d every h hrs m mins s secs

If these parameters are set to a non-zero value, the router will transmit heartbeat packets to the specified IP address/hostname at the specified interval.

Use interface x,y for the source IP address

Allows the selection of the source interface for the UDP heartbeats. For example, it may be required to send the heartbeat packets down a VPN tunnel. And in order to match the corresponding subnets of the VPN, it might require changing the source IP to match an inside Ethernet interface.

For normal operation, using the mobile interface as the source IP address, leave this value unchanged.

Select transmit interface using the routing table

When enabled, the UDP heartbeats chooses the best route from the routing table. If disabled the exit interface will be interface on which the heartbeat is configured.

Include IMSI information in the Heartbeat message

When enabled, the heartbeat includes the IMSI of the wireless module.

Include GPS information in the Heartbeat message

When enabled, the heartbeat includes the GPS co-ordinates of the router.

Generate Ping packets on this interface

This section relates to monitoring pings which can be sent from the mobile interface. For more details, refer to [Application Note 7: Wireless WAN problem Detection and Recovery](#). When enabled, displays the following parameters:

- Generate Ping packets on this interface**
- Send byte pings to IP host every hrs mins secs
- Send pings every hrs mins secs if ping responses are not being received
- Switch to sending pings to IP host after failures
- Ping responses are expected within seconds
- Only send Pings when this interface is "In Service"
- New connections to resume with previous Ping interval
- Reset the link if no response is received within seconds
- Use the ETH 0 IP address as the source IP address
- Defer sending pings if IP traffic is being received

Send n byte pings to IP host a.b.c.d every h hrs m mins s secs

If this parameter is set, the router automatically generates a ping of n size to the IP host specified (IP address or hostname) at the interval specified. Deleting the IP host value disables the monitoring ping facility.

This parameter in conjunction with **Reset the link if no response is received within s seconds**, configures the router to use a back-up interface automatically should there be a problem with this interface.

Note The **n** parameter specifies the ping size when using monitoring ping feature. The size indicates how large the ICMP packet should be excluding the size of the IP header.

Send pings every h hrs m mins s secs if ping responses are not being received

When set, the router uses this value as the interval to ping at when more than one ping request sent out the PPP interface is outstanding. This should be set to a shorter interval than the above ping request interval so that the router may more quickly react to a broken PPP link.

Switch to sending pings to IP host a.b.c.d after n failures

Allows a for more reliable problem detection before fail over occurs by testing connectivity to 2 IP addresses/hostnames. If an IP address or host name is entered and the n parameter has a value greater than 0, when a ping failure is detected on the primary IP address, pings are sent to this second IP address/hostname. This ensures that if the main IP address becomes unavailable for any reason and stops responding to ICMP requests, the router will check another IP address before starting fail over procedures.

Ping responses are expected within n seconds

When set to a non-zero value, the router waits for the interval specified for a response from a PING request before applying the **Send pings every h hrs m mins s secs if ping responses are not being received**. If this parameter is set to **0** (default), the time specified in the in **Send n byte pings to IP host a.b.c.d every h hrs m mins s secs** is allowed before applying the **Send pings every h hrs m mins s secs if ping responses are not being received**.

Only send Pings when this interface is “In Service”

When enabled, the interface sends ICMP echo requests only when it is in service. The default setting is **off**, and ICMP echo requests are sent when the interface is in service and out of service.

New connections to resume with previous Ping interval

When enabled, this parameter controls the ping interval after deactivating and subsequently reactivating the mobile interface. It sets the ping interval to the same interval in use when the mobile link last disconnected.

Reset the link if no response is received within s seconds

An amount of time after which the device does not receive any ping response, the router terminates the mobile connection in an attempt to re-establish communications. Because by default the mobile link is always on, the router automatically attempts to re-establish a PPP connection that has been terminated.

Use the ETH 0 IP address as the source IP address

When enabled, the router uses the IP address of **ETH0** instead of the current IP address of the mobile interface as the source address for the auto ping packets.

Note This parameter is useful to send the monitoring pings down a VPN tunnel where the source IP address needs to match the LAN. Defer sending pings if IP traffic is being received

When enabled, the timer configured in the **Send n byte pings to IP host a.b.c.d every h hrs m mins s secs** parameter is reset if IP data is sent across the mobile link.

4. Click **Apply**.

**Command line****Advanced mobile parameters for SIM Slot 1 (PPP 1)**

Command	Instance	Parameter	Values	Equivalent web parameter
modemcc	0	puk	sim puk code	SIM PUK/Confirm SIM PUK
modemcc	0	init_str	Free text field	Initialisation string 1
modemcc	0	init_str1	Free text field	Initialisation string 2
modemcc	0	init_str2	Free text field	Initialisation string 3
modemcc	0	hang_str	Free text field	Hang-up string:

Command	Instance	Parameter	Values	Equivalent web parameter
modemcc	0	posthang_str	Free text field	Post Hang-up string:
modemcc	0	intercall_idle	0-2147483647	Wait n seconds between hanging up and allowing another call
modemcc	0	att_interval	0-2147483647	Wait n seconds between attachment attempts
modemcc	0	link_retries	0-2147483647	Reset the module after n unsuccessful connection attempts
modemcc	0	stat_retries	0-2147483647	Reset the module after n unsuccessful status retrieval attempts
modemcc	0	ss_interval	0-2147483647	Create a signal strength event every n minutes
modemcc	0	check_reg	0, 1, 2	If registration is lost for 5 minutes 0=do not reset the module 1=reset the module if the GSM registration is lost 2=reset the module if the GPRS registration is lost
modemcc	0	psys	0, 1, 2, 2G, 3G, 4G, 4G3G2G, 4G3G, 4G2G3G, 4G2G, 3G4G2G, 3G4G, 3G2G4G, 3G2G, 2G4G3G, 2G4G, 2G3G4G, 2G3G	Preferred System. This parameter allows the module to “lock” to a particular connection type. Possible values include: 0=Auto. Uses default setting, may be set by the carrier in the SIM 1=GSM 2=WCDMA 2G=2G only 3G=3G only 4G=4G only 4G3G2G=4G, 3G, or 2G only 4G3G=4G or 3G only 4G2G3G= 4G, 2G, 3G only 4G2G=4G, or 2G only 3G4G2G=3G, 4G, or 2G only 3G4G=3G or 4G only 3G2G4G=3G, 2G, or 4G only 3G2G=3G or 2G only 2G4G3G= 2G, 4G, or 3G only 2G4G=2G or 4G only 2G3G4G=2G, 3G, or 4G only 2G3G=2G or 3G only

Advanced mobile parameters-for SIM Slot 2 (PPP 1)

Command	Instance	Parameter	Values	Equivalent web parameter
modemcc	0	Puk_2	sim puk code	SIM PUK/Confirm SIM PUK
modemcc	0	init_str_2	Free text field	Initialisation string 1
modemcc	0	init_str1_2	Free text field	Initialisation string 2
modemcc	0	init_str2_2	Free text field	Initialisation string 3
modemcc	0	hang_str_2	Free text field	Hang-up string:
modemcc	0	posthang_str_2	Free text field	Post Hang-up string:
modemcc	0	intercall_idle_2	0-2147483647	Wait n seconds between hanging up and allowing another call
modemcc	0	att_interval_2	0-2147483647	Wait n seconds between attachment attempts
modemcc	0	link_retries_2	0-2147483647	Reset the module after n unsuccessful connection attempts
modemcc	0	stat_retries_2	0-2147483647	Reset the module after n unsuccessful status retrieval attempts
modemcc	0	ss_interval_2	0-2147483647	Create a signal strength event every n minutes
modemcc	0	check_reg_2	0, 1, 2	If registration is lost for 5 minutes 0=do not reset the module 1=reset the module if the GSM registration is lost 2=reset the module if the GPRS registration is lost

Command	Instance	Parameter	Values	Equivalent web parameter
modemcc	0	Psys_	0, 1, 2, 2G, 3G, 4G, 4G3G2G, 4G3G, 4G2G3G, 4G2G, 3G4G2G, 3G4G, 3G2G4G, 3G2G, 2G4G3G, 2G4G, 2G3G4G, 2G3G	Preferred System 0=Auto 1=GSM 2=WCDMA 2G=2G only 3G=3G only 4G=4G only 4G3G2G=4G, 3G, or 2G only 4G3G=4G or 3G only 4G2G3G= 4G, 2G, 3G only 4G2G=4G, or 2G only 3G4G2G=3G, 4G, or 2G only 3G4G=3G or 4G only 3G2G4G=3G, 2G, or 4G only 3G2G=3G or 2G only 2G4G3G= 2G, 4G, or 3G only 2G4G=2G or 4G only 2G3G4G=2G, 3G, or 4G only 2G3G=2G or 3G only

Mobile network settings

Command	Instance	Parameter	Values	Equivalent web parameter
ppp	1	metric	0-256	Metric
ppp	1		off, on	Generate Heartbeats on this interface
ppp	1	hrtbeatip	IP address	Send Heartbeat messages to IP address a.b.c.d every h hrs m mins s secs
ppp	1	hrtbeatint	0-2147483647 (seconds)	Send Heartbeat messages to IP address a.b.c.d every h hrs m mins s secs
ppp	1	hbipent	Default,PPP,Ethernet	Use interface x,y for the source IP address
ppp	1	hbipadd	number	Use interface x,y for the source IP address
ppp	1	hbroute	on/off	Select transmit interface using the routing table

Command	Instance	Parameter	Values	Equivalent web parameter
ppp	1	hbimsi	on/off	Include IMSI information in the Heartbeat message
ppp	1	hbgps	on/off	Include GPS information in the Heartbeat message
ppp	1		off, on	Generate Ping packets on this interface
ppp	1	pingsiz	number	Send n byte pings to IP host a.b.c.d every h hrs m mins s secs
ppp	1	pingip	IP address	Send n byte pings to IP host a.b.c.d every h hrs m mins s secs
ppp	1	pingint	0-2147483647 (seconds)	Send n byte pings to IP host a.b.c.d every h hrs m mins s secs
ppp	1	pingint2	0-2147483647 (seconds)	Send pings every h hrs m mins s secs if ping responses are not being received
ppp	1	pingip2	IP address	Switch to sending pings to IP host a.b.c.d after n failures
ppp	1	ip2count	number	Switch to sending pings to IP host a.b.c.d after n failures
ppp	1	pingresp	0-2147483647	Ping responses are expected within n seconds
ppp	1	pingis	on/off	Only send Pings when this interface is In Service
ppp	1	ping2cont	on/off	New connections to resume with previous Ping interval
ppp	1	pingdeact	0-2147483647	Reset the link if no response is received within s seconds

Command	Instance	Parameter	Values	Equivalent web parameter
ppp	1	pingfreth0	on, off	Use the ETH 0 IP address as the source IP address
ppp	1	pingresetint	on, off	Defer sending pings if IP traffic is being received

Configure sending and receiving SMS messages

You can configure the mobile routers to send and receive SMS messages. The sending of SMS messages could for example be in conjunction with sending alarms and received messages for configuration changes, or status requests.

Note SMS messaging is supported in some, but not all, cellular modules in Digi TransPort routers.

Web

1. Go to **Configuration - Network > Interfaces > Mobile > SMS Settings**.

▼ SMS Settings

Poll for incoming SMS messages
 every minutes

Send received SMS messages to the command interpreter

Enable command replies via SMS

Concatenate replies

Use this SMS message centre number instead of the network default

SMS access level: ▼

Use as a command separator (default is CR)

Allow CLI commands from the following SMS numbers.
 You may specify up to 10 numbers. Specifying * permits commands from any SMS number.

Number	
<input type="text" value="9523935841"/>	<input type="button" value="Delete"/>
<input type="text" value="19523935841"/>	<input type="button" value="Delete"/>
<input type="text"/>	<input type="button" value="Add"/>

2. Enter the SMS settings:

Poll for incoming SMS messages

When enabled, displays the following parameter:-

Every n minutes

The interval, in minutes, that the router will wait in between checks for incoming SMS messages. Setting this interval to 0 turns off checking.

Send received SMS messages to the command interpreter

If enabled, any received SMS messages are sent to the command interpreter.

Enable command replies via SMS

Enables or disables replies to SMS commands.

Concatenate replies

Normally an SMS message is limited to 160 characters. However, the ETSI standard specifies a way to allow a number of SMS messages to be linked together by the sender (in this case the router). This enables the router to reply with long responses to SMS commands of longer than 160 characters. The reply comes back as a series of linked SMS messages which the phone reassembles and displays as one big message.

Note The routers cannot handle received concatenated SMS messages, it can only transmit concatenated SMS messages

Use this SMS message centre number n instead of the network default

This setting is optional. It is the number of the SMS message center (sometimes referred to as the Service Centre Address), for relaying SMS messages or alarms. This number must include the international dialing code, such as **44** for the UK, but not the **+** prefix or leading zeros, such as **44802000332**. SMS alarms are generated when the SMS trigger priority is greater than 0 and an event of this priority or higher occurs. SMS alarms may be configured using the **Configuration > Alarms > Event Settings > SMS** web page. If no number is specified, it is possible that the router operates using the default message centre for the GSM service to which you have subscribed.

SMS access level

The access level for SMS commands. The access level set here needs to match the level required by the command sent by SMS for the command to be accepted.

Use x as a command separator (default is CR)

The character for separating multiple command lines when a remote SMS sender is controlling the router. The default separator is **<CR>**. As some SMS capable devices are not equipped with **<CR>** keys, an additional means of separating multiple lines is required.

Allow CLI commands from the following SMS numbers.

You can specify up to **10** numbers. Specifying ***** permits commands from any SMS number. Numbers are applied in the following input box. Click **Add** to submit.



Command line

Commands-for SIM Slot 1 (PPP 1)

Command	Instance	Parameter	Values	Equivalent web parameter
modemcc	0	sms_ interval		Poll for incoming SMS messages:- Every n minutes
modemcc	0	sms_ replies	on/off	Enable command replies via SMS
modemcc	0	sms_ concat	Number 0=off 10=default when enabled	Concatenate replies

Command	Instance	Parameter	Values	Equivalent web parameter
modemcc	0	sca	Free text field	Use this SMS message centre number n instead of the network default
modemcc	0	sms_access	0=Super (default) 1=High 2=Medium 3=Low 4=None 5=HighLow 6=HighMedium 7=CheckPar	SMS access level:
modemcc	0	sms_cmd_sep	Free text field	Use as a command separator (default is CR)
modemcc	0	sms_callerid	Mobile telephone number	Allow CLI commands from the following SMS numbers. (First SMS number)
modemcc	0	sms_callerid_1 to 9	Mobile telephone number	Allow CLI commands from the following SMS numbers. (additional SMS numbers 1 to 9)

Commands-for SIM Slot 2 (PPP 1)

Command	Instance	Parameter	Values	Equivalent web parameter
modemcc	0	sms_interval_2		Poll for incoming SMS messages:- Every n minutes
modemcc	0	sms_replies_2	on/off	Enable command replies via SMS
modemcc	0	sms_concat_2	Number 0=off 10=default when enabled	Concatenate replies
modemcc	0	Sca_2	Free text field	Use this SMS message centre number n instead of the network default

Command	Instance	Parameter	Values	Equivalent web parameter
modemcc	0	sms_access_2	0=Super (default) 1=High 2=Medium 3=Low 4=None 5=HighLow 6=HighMedium 7=CheckPar	SMS access level:
modemcc	0	sms_cmd_sep	Free text field	Use as a command separator (default is CR)
modemcc	0	sms_callerid	Mobile telephone number	Allow CLI commands from the following SMS numbers. (First SMS number)
modemcc	0	sms_callerid_1 to 9	Mobile telephone number	Allow CLI commands from the following SMS numbers. (additional SMS numbers 1 to 9)

Verify mobile connectivity and check mobile status

Once the router is correctly configured for mobile service, verify that it has obtained an IP address from the mobile network, that the SIM is working correctly, and check the status of the mobile connection.

Web

1. Go to **Management > Network Status > Interfaces > Mobile**.
2. In the **Mobile Statistics** section, check the **IP address** value. It should contain an IP address other than **0.0.0.0** or **1.2.3.4**.

Mobile Statistics

```

IP Address: 100.76.191.24
Primary DNS Address: 198.224.149.135
Secondary DNS Address: 198.224.148.135
Data Received: 620 bytes
Data Sent: 436 bytes
  
```

3. In the **Mobile Information** section, view the **SIM status** field to verify that the SIM is working correctly.
4. View the **Signal strength** field to check the signal strength.

Mobile Information

```

Results of Last Module Status Poll at 30 Jan 2018 13:50:34
Outcome: Got modem status OK
  
```

```

SIM status: Ready
Signal strength: -70 dBm
Radio technology: LTE
Signal quality (LTE): RSSI -70 dBm, RSRP -102 dBm, RSRQ -11 dB,
SINR 3.4 dB
  
```

For more information about the fields on the mobile status page, see [Show mobile status and statistics](#).

Command line

1. Enter the command **pppstat n**, where **n** is the number of the PPP interface the mobile interface uses. Check the **IP Address** value.

```

pppstat 1
      Name: W-WAN
      Interface mode: NDIS
      Link Active With: USBHOST 0
      IP Address: 100.75.30.168
      DNS Server Address: 198.224.149.135
      Secondary DNS Server Address: 198.224.148.135
      Outgoing Call To: *98*3#
      Uptime: 1 Hrs 24 Mins 27 Seconds
OK
  
```

2. Enter the command **modemstat ?**. In the output, check the **SIM status** and **Signal strength** fields.

```
modemstat ?

Outcome: Got modem status OK:
Time: 30 Jan 2018 14:05:37
SIM status: Ready
Signal strength: -70 dBm
Radio technology: LTE
Signal quality (LTE): RSSI -70 dBm, RSRP -102 dBm, RSRQ -15 dB, SINR 5.2 dB
Radio band: E-UTRA Operating Band 4
Channel: 2050
Manufacturer: Sierra Wireless, Incorporated
Model: MC7455
IMEI: 359072060221435
MEID: 35907206022143
IMSI: 311480264291718
MDN: 6122573855
MIN: 6123322024
ICCID: 89148000002636797505
Firmware: SWI9X30C_02.24.05.06 r7040 CARMD-EV-FRMWR2 2017/05/19 06:23:09
Bootcode: SWI9X30C_02.24.05.06 r7040 CARMD-EV-FRMWR2 2017/05/19 06:23:09
Hardware version: 1.0
Firmware Carrier ID: VERIZON_002.034_000
APN in use: Context 3: vzwinternet
Registration State: Registered tac:BE43 ci:02E90520
Attachment status: Attached
Network: VZW, 311480
Preferred system: Auto
Network Technology: LTE
Temperature: 39C
OK
```

Automatic SIM detection

Newer cellular modules in TransPort routers use a SIM-based image switching feature, called automatic SIM detection, which allows the module to automatically switch between carrier-approved firmware. Automatic SIM detection is currently supported in the following cellular module types:

- Sierra Wireless modules MC7430 and MC7455
- Telit modules LE910-NA1, LE910-EU1, LE910-NA V2, LE910-EU V2, LE910C1-NS, LE910C1-AP

To determine whether your router supports automatic SIM detection, enter the command **modemcc 0 auto_sim ?**. The response will display **on** if automatic SIM detection is supported, or **off** if not supported.

When a Transport router equipped with automatic SIM detection boots, the cellular module checks the SIM's MCC/MNC or ICCID, and checks the list of cached images for a "best match:"

- If an exact or acceptable match is found, the router uses that image for the carrier firmware switch.
- If there is no exact or acceptable matching image, the router uses the Generic carrier firmware image, if available.

Otherwise, if there is no match, and no Generic carrier firmware image is available, no firmware image switch occurs, and the module continues to use the current configuration.

You can disable automatic SIM detection if desired.

Disable automatic SIM detection

If you want to switch carriers by using the **carrier** command (see [Switch the cellular carrier firmware](#)), you need to first disable automatic SIM detection.



Command line

To disable automatic SIM detection, use the **modemcc 0 auto_sim off** command:

```
modemcc 0 auto_sim off
```

Determine the cellular module type and carrier firmware version

The capabilities and options available for carrier switching and carrier firmware updates can vary by cellular module. You can determine the cellular module type and current carrier firmware version running on the cellular module from the router's web and command-line interfaces.

For more information on carrier switching, see [Switch the cellular carrier firmware](#). For more information on carrier firmware updates, see [Update carrier firmware](#).

Web

1. Go to **Management > Network Status > Interfaces > Mobile**.
2. On the mobile status display, check these fields:
 - **Manufacturer:** The manufacturer of the cellular module.
 - **Model:** The cellular module type.
 - **Firmware Carrier ID:** The current carrier firmware running on the cellular module, and its version number.

Command line

1. Enter the command **modemstat ?**
2. In the output, check these fields:
 - **Manufacturer:** The manufacturer of the cellular module.
 - **Model:** The cellular module type.
 - **Firmware Carrier ID:** The current carrier firmware running on the cellular module, and its version number.

Switch the cellular carrier firmware

You can switch the cellular carrier firmware for the router's cellular module.

Depending on the cellular module running on the router, there are several methods available for switching cellular carrier firmware. See [Determine the cellular module type and carrier firmware version](#).

- Some cellular modules require using the Carrier Switching Wizard in the web interface to switch carrier firmware.
- Some cellular modules, such as the Sierra Wireless MC7455, have all supported carrier firmware available on the module. For these modules, use the **carrier** command to switch carrier firmware.

Using the Carrier Switching Wizard

Web

Older cellular modules that do not support automatic SIM detection perform carrier switching through the **Carrier Switching Wizard** in the web interface.

1. If necessary, verify which carrier firmware is currently running on the cellular module. See [Determine the cellular module type and carrier firmware version](#).
2. Verify that the router has enough available flash space to receive the firmware files.
3. (Optional) Depending on available router flash space, delete any unused *.cwe files to free up space in the flash directory. Use the **del** command to delete files. For example:
 - Go to **Administration > File Management > FLASH Directory**.
 - Select the file or files to delete.
 - Click **Delete Selected Files**.
4. Load the carrier firmware images for the carrier in flash or USB drive, if they are not already loaded there.
5. Go to **Wizards > Carrier Switching Wizard** and click **Next**.

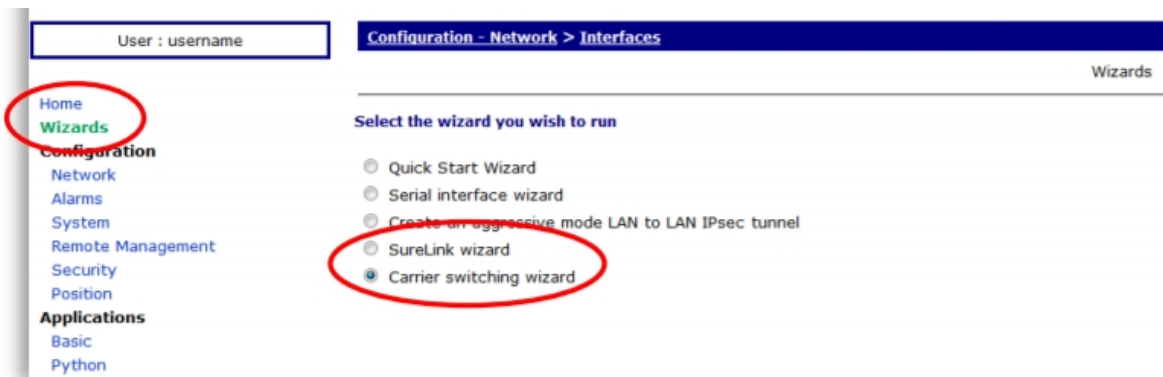

6. Select the required carrier and click **Next**.

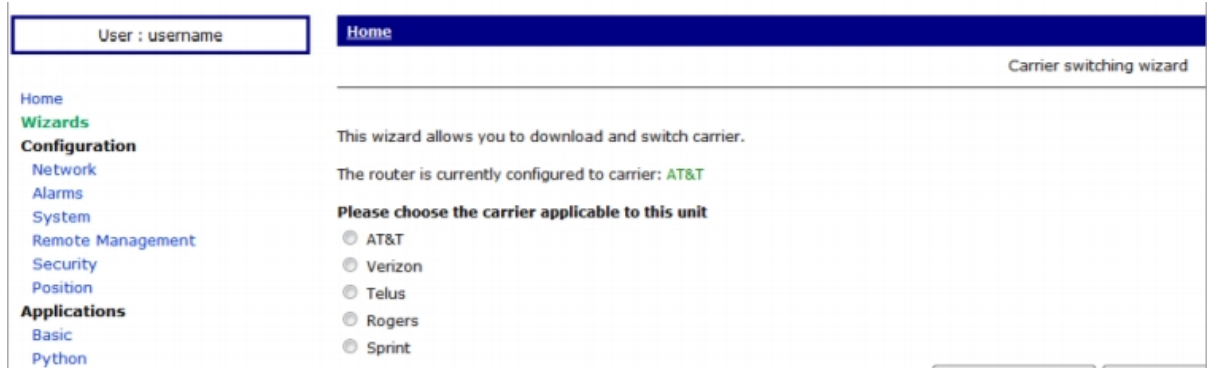

The firmware update begins.

Note The update process takes several minutes. Do not power-cycle the router until the process is complete.

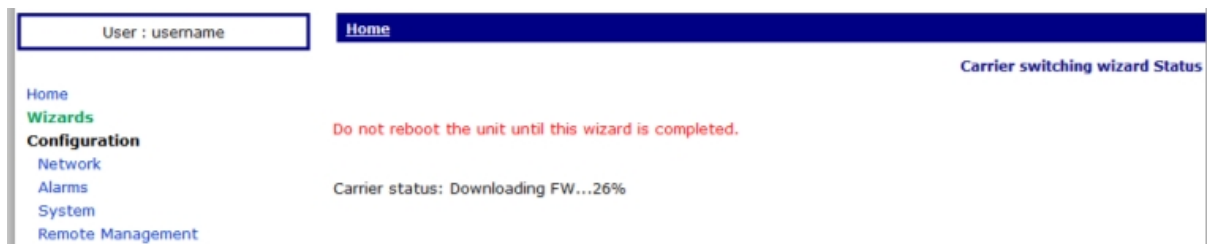

7. Once the firmware update is complete, you may need to update the modem parameters, such as **APN**, for the carrier. To do this, click on the link in **Click here to update Mobile Settings** on the final wizard page.

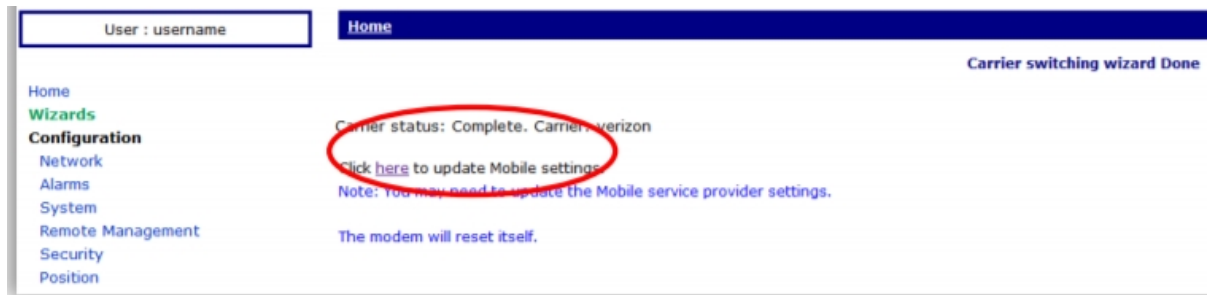

Using the "carrier" command

Newer cellular modules that support automatic SIM detection perform carrier switching through the **carrier** command. The **carrier** command has several command variants; the availability of which depends on the cellular module.

"carrier" command variant	Action
carrier ?	Displays help text for the carrier command. In the help text, the available carriers are listed under the Parameters: heading. Available command variants are listed under the Syntax: heading.
carrier carrier optional msl	Downloads the carrier firmware files to the cellular modem. The carrier firmware file must be in flash or on a USB stick. You can also specify a Master Subsidy Lock (MSL) code, if the carrier requires it.
carrier carrier optional msl -ftp	Downloads the carrier firmware files from the Digi FTP repository for the cellular modem's firmware to the cellular modem. You can also specify a Master Subsidy Lock (MSL) code, if the carrier requires it.
carrier ftp-carrier-info	Downloads the specific carrier firmware for the carrier that is active on the module.
carrier switch {auto carrier}	Switch to automatic SIM selection or a preloaded carrier image.
carrier all	Supported for Telit cellular modules only. Loads all available carrier firmware onto the cellular module.
carrier status	Show status of the current carrier firmware download operation.

1. Enter **carrier ?** to verify which carrier firmware is currently running on the cellular module.
2. Verify that the router has enough available flash space to receive the firmware files.

```

carrier ?
Current images:
  FW image: unique ID = 002.009_001 build ID = 02.08.02.00_ATT
  PRI image: unique ID = 002.009_001 build ID = 02.08.02.00_ATT

Available carriers <att|verizon|telus|rogers|bell|sprint|generic>

Parameters:
  att - AT&T
  verizon - Verizon
  telus - Telus
  rogers - Rogers
  bell - Bell
  sprint - Sprint
  generic - Generic

Syntax:
carrier <carrier> <optional msl>          Download firmware to the modem, must
be in flash or USB stick
    
```

```

carrier <carrier> <optional msl> -ftp  FTP and download firmware to the
modem
carrier ftp-carrier-info                FTP latest carrier
information file
carrier switch <carrier>                Switch to preloaded carrier
image
carrier status                          Status of the current
download

msl - Enter Master Subsidy Lock Code for Sprint
OK

```

- (Optional) Depending on available router flash space, delete any unused ***.cwe** files to free up space in the flash directory. Use the **del** command to delete files. For example:

```
del att.cwe
```

- Disable automatic SIM detection using the **modemcc** command:

```
modemcc 0 auto_sim off
```

- Depending on the carrier command options available for the cellular module, enter the **carrier** command. For example, to switch the carrier firmware to Verizon, enter:

```

carrier verizon
Checking the firmware and the carrier
Waiting for the modem.....
Downloading verizon.cwe file 100%
Download speed: 2702400 bps time 102720ms
Downloading verizon.nvu file 100%
Download speed: 2403200 bps time 250ms
Waiting modem to complete firmware download
Firmware download completed
Done.
Modem will be reset

```

Note The update process takes several minutes. Do not power-cycle the router until the process is complete.

- Once the module's firmware image has been updated, you may need to configure the modem parameters for the carrier, for example, the **APN** value.
- Enable automatic SIM detection using the **modemcc** command:

```
modemcc 0 auto_sim on
```

Additional model-specific carrier-switching documentation

For additional information on switching carriers on the cellular module, see these Digi TransPort application notes:

- [Quick Note 39: Carrier Switching with the Sierra Wireless MC7354 Cellular Module \(L5 models\)](#)
- [Quick Note 58: MC7455 Firmware update/SIM Switching](#)

Update carrier firmware

Depending on the cellular module in the router, there are several options available for handling carrier firmware updates. See [Determine the cellular module type and carrier firmware version](#).

- Using the **Configuration > Network > Interfaces > Mobile > Mobile Firmware (OTA) Update** page in the web interface. Currently available on select newer cellular modules only. If you do not see this settings group on the Mobile page for your device, the cellular module does not support this option.
- Using the **carrier -ftp** command. Available for all newer cellular modules.

The carrier firmware over-the-air update process is automated. It pulls the required firmware files from Digi's FTP site for TransPort WR routers, and performs the update. This update occurs for the active carrier only.

About carrier firmware files

While firmware files and file types can vary among manufacturers and model types, in general, carrier firmware files involve these file types:

- A text file that cross-references the carrier to the corresponding firmware and configuration files. Depending on the cellular module, this file may be named **carrier.txt** or have a more module-specific name, such as **car_7455.txt** for the Sierra Wireless MC7455 module.
- A cellular modem firmware file. The size of this file can vary among carriers. This file typically has the format ***.cwe**
- A carrier-specific configuration file, again with a file size that can vary in size by carrier. This file typically has the format ***.nvu**.

Web

1. Verify that the router has enough available flash space for the carrier firmware files.
2. (Optional) Depending on available router flash space, delete any unused ***.cwe** files to free up space in the flash directory:
 - Go to **Administration > File Management > FLASH Directory**.
 - Select the file or files to delete.
 - Click **Delete Selected Files**.
3. Go to **Network > Configuration > Interfaces > Mobile > Mobile Firmware (OTA) Update**.
4. Click **Start**.

Command line

1. Verify that the router can ping to the location **ftp1.digi.com**.
2. Verify that the router has enough available flash space for the carrier firmware files (around **40 MB**).
3. (Optional) Depending on available router flash space, delete any unused ***.cwe** files to free up space in the flash directory. Use the **del** command to delete files. For example:

```
del att.cwe
```

4. Use the **carrier carrier_name** or **carrier carrier_name -ftp** command to load the carrier firmware images onto the router.

The **carrier carrier_name** command checks for the carrier firmware on a USB stick or in flash and loads it onto the router.

The **carrier carrier_name -ftp** command performs the following actions:

- Downloads the latest firmware files for the current carrier from the Digi FTP site to flash.
- Checks to see if a firmware download is required (a newer version is available)
- Downloads the files from flash to the MC7354.
- Reboots the cellular module.

For example, to update the carrier firmware for AT&T, enter:

```
carrier att -ftp
Checking the firmware and the carrier
Please wait while retrieving the file.....
OK
config 0 save
Please wait...
Power Up Profile: 0
OK
.....
Downloading att.cwe file 100%
Download speed: 7473600 bps time 37240ms
Waiting modem to complete firmware download
Firmware download completed
Resetting modem...
Done.
OK
```

The download operation requires several minutes.

Note Do not reboot the TransPort during the process.

5. Check the event log for the following messages when firmware is successfully downloaded; the message **firmware download complete** indicates a successful firmware download:

```
13:51:33, 07 Apr 2017,GOBI Modem enable
13:51:33, 07 Apr 2017,GOBI firmware download complete
13:51:33, 07 Apr 2017,GOBI file att.cwe download complete (34790809 bytes)
13:51:31, 07 Apr 2017,GOBI write unframed response timeout
13:51:23, 07 Apr 2017,GOBI write unframed response timeout
13:50:56, 07 Apr 2017,GOBI firmware download start
Done.
OK
```

Troubleshooting carrier firmware updates

If the carrier firmware file download fails and an error message is displayed, check the following things:

carrier download fails and an error message is displayed, try checking the following things:

- Check for errors in the event log; verify that the FTP download did not report errors.
- If using FTP, verify that enough flash space is available. Required size varies by carrier; you may need anywhere from **40** to **62** MB available.
- If using FTP, verify that you can ping the location **ftp1.digi.com**.
- If not using FTP, verify that the images are available in flash or USB. For example, for updating the Verizon carrier firmware on a Sierra Wireless MC7455 module, the files **car_7455.txt**, **verizon.cwe**, and **verizon.nvu** must be available.

Configure DSL interfaces

Router models incorporating a DSL broadband interface includes a configuration page having the title shown above. By default, the configuration in this section is suitable for the majority of ADSL service providers in the UK. However, advanced users or users outside of the UK may want or need to adjust some of the parameters.

Web

1. Go to **Configuration > Network > Interfaces > DSL**.
2. Configure the DSL parameters as needed:

Enable DSL

Enables or disables the use of DSL/ADSL functionality on the router.

Configure PVC

Select the required PVC instance from the drop-down selection box. Subsequent settings applies to the selected instance. See additional topics in this section.

3. Click **Apply**.

Configure permanent virtual circuit (PVC) parameters

Web

1. Go to **Configuration > Network > Interfaces > DSL > PVC**.
2. Configure PVC parameters as needed:

Enable this PVC

Check this box to enable PVC settings.

Encapsulation

The method of encapsulation to use when transporting data over this APVC. The appropriate value can be selected from a drop list which includes the following options:

Option	Description
PPPoA VC-Mux	RFC 2364 VC-multiplexed PPP over AAL5
PPPoA LLC	RFC 2364 LLC encapsulated PPP over AAL5
PPPoE VC-Mux	RFC 2516 VC-multiplexed PPP over Ethernet
PPPoE LLC	RFC 2516 LLC encapsulated PPP over Ethernet
Bridged Ethernet VC-Mux	RFC 2684 VC-multiplexed bridged Ethernet
Bridged Ethernet LLC	RFC 2684 LLC encapsulated bridged Ethernet
Routed IP VC-Mux	RFC 1483 VC multiplexing routed IP over ATM
Routed IP LLC	RFC 1483 LLC encapsulated routed IP over ATM

To use PPPoA or PPPoE encapsulation, one of the available PPP instances must first be configured to use this APVC instance as its Layer 1 interface on the associated **Configuration > Interfaces > PPP > PPP n > Advanced page**.

VPI

The Virtual Path Identifier for this APVC in the range **0-255**.

VCI

The Virtual Channel Identifier for this APVC in the range **0-65535**.

3. Click **Apply**.

Command line

Command	Instance	Parameter	Values	Equivalent web parameter
apvc	0		0-255	VPI
apvc	0		0-65535	VCI

Configure DSL network settings

Web

1. Go to **Configuration > Network > Interfaces > DSL > Network Settings**.
2. Configure the DSL parameters as needed:

This DSL PVC is using PPP 1

The default interface for DSL. The default interface for DSL is **PPP 1**.

Description

A description for the DSL. This field is optional.

Username

The ADSL username.

Password

The password for the DSL account.

Confirm password

Enter the password for the DSL account again.

Enable NAT on this interface

Enables or disables IP Network Address Translation (NAT) or Network Address and Port Translation (NAPT) at the Ethernet interface. When the parameter is set to disabled, no NAT occurs. When this parameter is enabled, the extra options described below are displayed.

NAT and NAPT can have many uses, but they are generally employed to allow a number of private IP hosts (PCs for example) to connect to the Internet through a single shared public IP address. This has two main advantages, it saves on IP address space (the ISP only need assign you one IP address), and it isolates the private IP hosts from the Internet, effectively providing a simple firewall because unsolicited traffic from the Internet cannot be routed directly to the private IP hosts.

To use NAT or NAPT correctly in the example of connecting private hosts to the Internet, enable NAT or NAPT on the router's WAN side interface and disable NAT or NAPT on the router's LAN-side interface.

IP address

Enable standard Network Address Translation (NAT)

When a private IP host sends a UDP or TCP packet to an Internet IP address, the router changes the source address of the packet from the private host IP to the router's public IP address before forwarding the packet onto the Internet host. Additionally it will create an entry in a NAT table containing the private IP source address, the private IP port number, the public IP destination address and the destination port number. Conversely, when the router receives a reply packet back from the public host, it checks the source IP, source port number and destination port number in the NAT table to determine which private host to forward the packet to. Before it forwards the packet back to the private host, it changes the destination IP address of the packet from its public IP address to the IP address of the private host.

IP address and Port

Enable Network Address and Port Translation (NAPT).

This mode behaves like NAT but in addition to changing the source IP of the packet from the private host it can also change the source port number. This is required if more than one private host attempts to connect using the same local port number to the same Internet host on the same remote port number. If such a scenario were to occur with NAT the router would be unable to determine which private host to route the returning packets to and the connection would fail.

NAT Source IP address

If specified, and NAT mode is set to NAT or NATP for this interface, then the source address of packets being sent out this interface is changed to this address, rather than the interface address.

Enable IPsec on this interface

The IPsec parameter enables or disables IPsec processing on this interface. If this box is checked, packets sent or received on this interface must pass through the IPsec code before being transmitted. IPsec may drop the packet, pass it unchanged, or encrypt and encapsulate within an IPsec packet.

Keep Security Associations (SAs) when this Mobile interface is disconnected

Configures the router to keep any existing IKE and IPsec associations should the link drop. This is usually applied on head-end routers with fixed IP addresses.

Use interface X, Y for the source IP address of IPsec packets

By default, the source IP address for an IPsec route is the IP address of the interface on which IPsec was enabled. By setting this parameter to either a PPP or Ethernet interface, the source IP address IPsec uses will match that of the Ethernet or PPP interface specified.

Enable the firewall on this interface

Turns Firewall script processing **On** or **Off** for this interface. If the firewall is enabled on an interface and with the absence of any firewall rules, the default action is to block ALL traffic. To configure the firewall, see the [Firewall](#) section.

Limit the data transmitted over this interface

On W-WAN networks (where charging is based on the amount of data transferred as opposed to time spent on-line), this parameter specifies a data limit after which the router will create an entry in the event log to indicate that this amount of data has been transferred. For example, if your monthly tariff includes up to 5 MB of data before you are charged an excess, you might set the Data limit warning level to **4000**. This would cause the router to place a warning entry in the event log once you had transferred **4** MB. You could use this event to trigger an email alert message, SNMP trap or SMS alert message.

Issue a warning event after

The maximum data to be transmitted before a warning entry is generated in the Event Log. You can select kilobytes, megabytes or gigabytes via the drop-down box.

Stop data from being transmitted after

The maximum amount of data that may be transferred before the router locks the interface and prevent further transfer. Along with the **Issue a warning event after** parameter, networks use this setting when the tariff is based on the amount of data transferred to help prevent excess charges being incurred. You can select **kilobytes**, **megabytes** or **gigabytes** via the drop-down box.

Reset the data limit on the x day of the month

If you wish to automatically unlock a locked interface at the start of a new billing period, set this parameter to the appropriate day of the month (from **1** to **28**). When this date is reached the router will unlock the interface and data transfer may resume. If the parameter is set to **0**, automatic unlocking will not occur and manual unlocking will be necessary (by clicking on the Clear Total Data Transferred button on the appropriate **Diagnostics-Statistics > PPP > PPP n** page. This parameter will also reset the statistics for the data limit warning level (in kilobytes). The factory default does not include any DSL settings and so when the router is first installed, the following message appears:

This DSL PVC is not assigned to any PPP interface.

Click here to jump to the PPP Mapping page.

When clicked, this link redirects the browser to the **Configuration > Network > interfaces > Advanced > PPP Mappings** page. From this page, select the desired PPP instance.

3. Click **Apply**.

**Command line**

Command	Instance	Parameter	Values	Equivalent web parameter
ppp	1	description	Free text	Description
ppp	1	username	Free text	Username
ppp	1	password	Free text	Password
ppp	1	do_nat 1	on	Enable NAT on this interface (IP Address)
ppp	1	do_nat 2	on	Enable NAT on this interface (IP Address and port)
ppp	1	natip	IP Address	NAT Source IP Address
ppp	1	ipsec	on, off	Enable IPsec on this interface
ppp	1	firewall	on, off	Enable the firewall on this interface
ppp	1	dlwarnkb	Kbytes/Mbytes/GBytes	Issue a warning event after
ppp	1	dlstopkb	Kbytes/Mbytes/GBytes	Stop data from being transmitted after x Bytes data

Command	Instance	Parameter	Values	Equivalent web parameter
ppp	1	dlrstday	1-28	Reset the data limit on the nth day of the month

Configure PVC traffic shaping parameters

Web

Service category

You can configure Each ATM PVC with a service category:

- **UBR** (unspecified bit rate, the default)
- **VBR-nrt** (variable bit rate, non-real-time)
- **VBR-rt** (variable bit rate, real-time)
- **CBR** (constant bit rate)
- Additional traffic parameters may be specified:
- **PCR** (peak cell rate in cells/sec)
- **SCR** (sustained cell rate in cells/sec)
- **MBS** (maximum burst size in cells)

The service categories are characterized by the various traffic parameters as follows:

Service category	Traffic parameters
UBR	PCR, which may be 0 for no limit
VBR-nrt	PCR, SCR, MBS
VBR-rt	PCR, SCR, MBS
CBR	PCR

This parameter specifies the maximum allowable rate at which cells can be transported along a connection in the ATM network. The PCR is the determining factor in how often cells are sent in relation to time in an effort to minimize jitter. PCR generally is coupled with the CDVT (Cell Delay Variation Tolerance), which indicates how much jitter is allowable.

Sustained cell rate (cells/sec)

A calculation of the average allowable, long-term cell transfer rate on a specific connection.

Maximum burst size (cells)

The maximum allowable burst size of cells that can be transmitted contiguously on a particular connection.

Related CLI commands**Command line**

Entity	Instance	Parameter	Values	Equivalent web parameter
apvc	0	servcat	UBR,VBR-ntr,VBR-rt,CBR	Service category
apvc	0	pcr	n	Peak cell rate (cells/sec)
apvc	0	scr	n	Sustained cell rate (cells/sec)
apvc	0	mbs	n	Maximum burst size (cells)

Configure advanced DSL parameters

Web

1. Go to **Configuration > Network > Interfaces > DSL > Advanced**.
2. Configure the advanced DSL parameters as needed:

Operational mode

The connection mode for the DSL link. The following options are available (default is Multi mode).

Values	Equivalent web parameter
Multi-mode	For Annex A models (such as PSTN / POTS) this option provides automatic selection between G.dmt, G.lite and ANSI (in the order listed). For Annex B models (such as ISDN) this option provides automatic selection between G.dmt (in the order listed)
ANSI	Annex A only-attempt to connect in ANSI T1.413 mode
G.dmt	Attempt to connect in ITU G.992.1 G.dmt mode
G.lite	Annex A only-attempt to connect in ITU G.992.2 G.lite mode
ADSL2	Connect using ADSL2
ADSL2+	Connect using ADSL2+

Load DSL firmware from flash file 'dspfw.bin' (if present)

Enables use of alternative +ADSL driver firmware and should only be enabled on the advice of the technical support team. This option also requires that an additional file be loaded onto the router.

Enable watchdog

This setting should only be enabled on the advice of Digi Technical Support.

Manage this PVC using ATM OAM cells

Using Alarm indication signal (AIS) cells downstream and Remote defect indication (RDI) cells upstream, the router can detect faults between the connecting points of the VP/VC and suspend transfer of ATM cells until the VC fault condition is cleared.

3. Click **Apply**.

Command line

Command	Instance	Parameter	Values	Equivalent web parameter
adsl	0	oper_mode	Multi,ANSI,G.dmt,G.lite,ADSL2,ADSL2+	Operational mode

Command	Instance	Parameter	Values	Equivalent web parameter
adsl	0	usefwfile	on, off	Load DSL firmware from flash file
adsl	0	watchdog	on, off	Enable watchdog
apvc	0	oammanage	on, off	Manage this PVC using ATM OAM cells

Additional CLI commands

The following command is not available from the web interface:

```
adsl 0 debug {0|1}
```

Where **0** is off and **1** causes debugging information to be sent to the CLI.

Configure Generic Routing Encapsulation (GRE) interfaces

Generic Routing Encapsulation (GRE) is a means of transporting IP packets from one device to another through an unencrypted point-to-point IP tunnel. You can configure multiple tunnels to multiple devices. Once configured, a GRE tunnel is created between two devices.

Configure GRE tunnel parameters

Web

1. Go to **Configuration > Network > Interfaces > GRE > Tunnel n**.

The screenshot shows the configuration page for a GRE tunnel. The breadcrumb path is Configuration > Network > Interfaces > GRE > Tunnel 0. The form includes the following fields and options:

- Description:** A text input field.
- IP Address:** A text input field.
- Mask:** A text input field containing the value 255.255.255.0.
- Source IP Address:** Two radio button options: "Use interface" (selected) and "Use IP Address". The "Use interface" option has a dropdown menu showing "0".
- Destination IP Address or Hostname:** A long text input field.
- Enable keepalives on this GRE tunnel:** A checked checkbox.
- Send a keepalive every:** A text input field containing the value 0, followed by the word "seconds".
- Bring this GRE tunnel down after no replies to:** A text input field containing the value 3, followed by the word "keepalives".
- Bring this GRE interface up to send keepalives:** A checked checkbox.

2. Configure the GRE tunnel parameters.

Description

A memorable name for this GRE instance, to make it easier to identify it.

IP address

The IP address of the virtual interface the tunnel uses. Use with the **Mask** parameter. You must enter this parameter for the tunnel to work.

Mask

Use this parameter with the IP address parameter to clarify the subnet in use on the virtual interface. This would normally be a 30-bit mask as this is a point-to-point link (**255.255.255.252**).

Source IP Address

The two sub options here allows you to specify a source address from a specified interface or by manually assigning an address. If you do not select either option, the router uses the default address for the route through which the packet leaves the router. If the interface through which the GRE packets exit does not have NAT enabled, the router uses the default router address, which is the **Ethernet 0** address.

Use Interface:

The GRE tunnel source interface, which allows the tunnel end point to be a physical interface rather than a virtual IP address. This is for using GRE without IPSec. Do not use these parameters if the parameter below uses the source address. Select the available interface type and number from the drop-down boxes.

Use IP Address:

A virtual host IP address for the local end of the tunnel, configured for routing purposes. This IP address has no other use and needs no mask as it is a host address, such as **1.1.1.1**. Normally, use this option in conjunction with IPsec. Do not use this parameter if the interface is selected as the source using the Use Interface options above.

Destination IP Address or Hostname

The FQDN or IP address of the remote end of the tunnel. This could also be the virtual host IP address for the remote end of the tunnel, configured for routing purposes. such as **2.2.2.2**.

Enable keepalives on this GRE tunnel

Enables or disables the GRE keepalive parameters. Keepalives are needed so allow the router to determine whether the tunnel interface is receiving traffic correctly or not. If keepalives fail, the tunnel is marked as down.

Send a keepalive every s seconds

When configured to a non-zero value, keepalive packets is sent to the remote end of the tunnel and the response is monitored to detect if the tunnel is up or down. If the tunnel is detected as down, the routing table metric will be altered. Value is configured in seconds. If this value is set to **0**, the router does not use keepalives.

Bring this GRE tunnel down after no replies to n keepalives

The consecutive number of keepalive packets that need to fail before the tunnel is detected as being down.

Bring this GRE interface up to send keepalives

Whether or not the GRE keepalive packets will activate the tunnel. If set to **YES** and the tunnel drops the GRE keepalive packet will try to raise the tunnel again. If set to **NO** and the tunnel has been marked as down due to the GRE keepalives not being received, the router will only raise the tunnel if a packet (other than a GRE keepalive) needs to be routed.

VRF

Associates the interface with a particular VRF.

Destination VRF

Associates the interface with a particular destination VRF.

3. Click **Apply**.

**Command line**

Command	Instance	Parameter	Values	Equivalent web parameter
tun	n	descr	Free text field	Description
tun	n	IPaddr	Valid IP address	IP Address

Command	Instance	Parameter	Values	Equivalent web parameter
tun	n	mask	Valid Subnet Mask	Mask
tun	n	source_ent	blank,ETH,PPP	Use interface x,y for the source IP address of GRE packets x=Interface type
tun	n	source_add	0-255	Use interface x,y for the source IP address of GRE packets y=interface number
tun	n	source	Valid IP address	Source IP address to use for GRE packets
tun	n	dest	Valid IP address	Destination IP address to use for GRE packets
tun	n	kadelay	Seconds	Send a keepalive every s seconds
tun	n	karetries	Number	Bring this GRE tunnel down after no replies to n keepalives
tun	n	kaactrq	On,off	Bring this GRE interface up to send keepalives
tun	n	vrf	integer	VRF
tun	n	vrfdest	integer	Destination VRF

Configure advanced GRE parameters

Web

1. Go to **Configuration > Network > Interfaces > GRE > Advanced**.

Advanced

Metric:

MTU: bytes

Include Tunnel key

Enable the firewall on this GRE tunnel

Enable GRE checksums

Enable IGMP on this GRE tunnel

Enable DNS inbound blocking

Enable IP analysis

Enable Tunnel analysis

Enable Multi-GRE mode on this GRE tunnel

NHRP Holding Time:

NHS Server:

Enable NHRP Spoke to Spoke mode on this GRE tunnel

Enable DMNR

2. Configure the advanced GRE tunnel parameters.

Metric

The connected metric of an interface. The default metric of a connected interface is **1**. By allowing the interface to have a higher value (lower priority), static routes can take preference to interfaces. For normal operation, leave this value unchanged.

MTU

The maximum transmission unit. In this text box you can enter the greatest amount of data that can be transferred in one physical packet. The default value is **1400**.

Include Tunnel Key

The interface normally uses this parameter with multi GRE (mGRE). The tunnel key adds an extra field to the GRE header where a key number can be applied. When enabled, incoming GRE packets must have a matching tunnel key number to be accepted by this tunnel. When enabled, the IP address parameter is not required.

Enable the firewall on this GRE tunnel

Turns Firewall script processing on or off for this interface. If using the firewall for problem detection on a tunnel interface, the interface to put OOS will need to be specified, such as:

```
pass out break end on tun n from any to 100.100.100.29 port=4000
flags S!A inspect-state oos ppp n 5
```

Enable GRE checksums

Selects whether to add GRE checksums to GRE packets when the router is terminating a GRE tunnel. Set this parameter to **off** to disable checksums, and to **on** to enables checksums.

Enable IGMP on this GRE tunnel

This IGMP parameter enables or disables the transmission and reception of IGMP packets on this interface. IGMP advertises members of multicast groups. If IGMP is enabled, and a member of a multicast group is discovered on this interface, multicast packets for this group received on other interfaces are sent out this interface.

Enable DNS inbound blocking

Enables or disables blocking DNS requests on the GRE tunnel, to prevent the tunnel from responding to DNS requests over this interface.

Enable IP analysis

When set to **on**, the un-encapsulated IP traffic is captured into the analyser trace.

Enable Tunnel analysis

When set to **on**, the GRE encapsulated packets and keepalives is captured to the analyser trace.

3. Click **Apply**.

**Command line**

Command	Instance	Parameter	Values	Equivalent web parameter
tun	n	metric	Numeric Metric value	Metric for the route associated with this interface
tun	n	MTU	MTU value	Maximum transmission unit size
tun	n	tunkey	Key number	Key number
tun	n	Firewall	on,off	Turn firewall on or off
tun	n	csum	on,off	Enable GRE checksums
tun	n	block_dns	on,off	Enable DNS inbound blocking
tun	n	igmp	on, off	Enable IGMP packets
tun	n	ipanon	on, off	Enable IP analysis for traffic on this interface
tun	n	tunanon	on, off	Enable GRE tunnel analysis

Note RIP Routing Parameters-command line only: In the command-line interface, there are commands and sub-parameters for GRE Tunnels that specifically relate to RIP. See [Configure Routing Information Protocol \(RIP\) settings](#) to configure these sub parameters.

Configure ISDN interfaces

TransPort routers fitted with an optional internal ISDN MODEM card have several ISDN configuration settings at **Configuration > Network > Interfaces > ISDN**. This page has several sets of configuration parameters:

- **ISDN Answering**
- **ISDN Dialling**
- **LAPD**

Configure the ISDN interface to receive incoming calls

Digi routers can answer incoming B-channel ISDN calls with three main protocols: rate adaptation protocols, LAPB, and PPP. Usually several instances of these protocols exist. This section explains how answering priorities work for the different protocols.

Protocol entities

The following protocol instances are capable of answering an incoming ISDN call:

Adapt

Adapt instances provide rate adaptation protocols such as V.120 or V.110.

LAPB

LAPB instances allow the router to answer incoming X.25 calls over ISDN. These instances can optionally connect the caller to a synchronous serial port, an asynchronous serial port bound to a PAD, or switch the call to another interface.

PPP

IP data tunneled over PPP instances allows remote access to the router's IP-based management features and also facilitates onward IP routing through any of the router's IP enabled interfaces.

The router automatically answers an incoming ISDN call if any of the following statements are true, subject to the entity's **MSN**, **Calling Number** and **Sub-address** parameters being set to their default values:

- An Adapt instance is bound to an asynchronous serial port (ASY) and the answer ring count (S0) for that serial port is set to 1
- A LAPB instance has its answering parameter set to On
- A PPP instance has its answering parameter set to On

If more than one of these protocols are configured to auto answer then the priority is as follows: Adapt instances (normally V.120) will take priority over LAPB, which will take priority over PPP. If an Adapt instance is bound to an asynchronous serial port (ASY port) but the answer ring count (ATS0) is not set to 1 for that same serial port then Adapt entity will not answer automatically. If any other protocol entities (such as LAPB, PPP or another Adapt instance) are configured to answer then one of these protocol entities will answer the call. If no other protocol entities are configured to answer then a repeating RING message will be sent out of the serial port and the RS232 ring indicator control will be activated. If a terminal attached to the serial port sends ATA followed by carriage return then the ISDN call will be answered by the Adapt entity and any incoming data will be channeled out of the serial port and vice-versa.

Multiple Subscriber Numbers

An MSN (multiple subscriber number) is an alternative number provided by the telephone service provider which when dialed will also route through to your ISDN line. It is possible to purchase several MSNs for an ISDN line. This means that in effect one ISDN line can have several ISDN numbers.

Every entity in the router which is capable of answering an ISDN call (Adapt, LABP and PPP) has an MSN parameter.

You can use a protocol entity's MSN parameter to:

- Cause a protocol instance not to answer an incoming ISDN call (if the trailing digits of the ISDN number called do not match the entry in this field).
- Increase the answering priority of an instance (if more than one protocol instance is configured to answer and the trailing digits of the ISDN number called match the value of the MSN parameter for a particular protocol instance).

Example

Consider the following:

- An Adapt instance is bound to a serial port and **ATS0** for that serial port is set to **1**.
- PPP instance **0** has answering turned **On**.
- The ISDN line to which the router is connected has two numbers: the main number is **123456** and the MSN number is **123789**.

Normally, because ADAPT has a higher answering priority than PPP, the Adapt instance will answer when either of the numbers are called. However if the ISDN number dialed is **123456** and **456** is entered into the MSN parameter of PPP, PPP will answer instead. This will also have the effect of preventing PPP from answering if any other ISDN number (such as **123457**) has been called.

This means that whenever **123456** is called the PPP instance will answer, and whenever **123789** is called, the V120 instance will answer.

You can connect multiple ISDN devices to the same ISDN line. Then, you can use MSNs to allow the different ISDN devices to be dialed individually (such as dial the main ISDN number), and get through to ISDN device one, dial the first MSN and get through to ISDN device number two, dial the second MSN, and get through to ISDN device number three, etc.).

Multiple PPP Instances

It is also possible to configure multiple instances of a particular entity to answer. For example, PPP instance, 0, 1 and 4 could be configured to answer. In this case, provided none of the PPP instances are busy, the PPP instance with the highest number will answer first. You can use MSNs to ensure that a chosen PPP instance answers the call.

The multiple protocol entity answering instance rules are as follows:

Adapt

The lowest free Adapt instance with auto-answering enabled will answer first.

PPP

The lowest free PPP instance with answering on will answer first.

LAPB

The lowest free LAPB instance with answering on will answer first.

Web

1. Go to **Configuration > Network > Interfaces > ISDN**The **ISDN Answering**. This page is for configuring the ISDN interface to receive incoming calls.
2. Configure the ISDN answering parameters:

Load answering defaults button

Click this to button resets the default answering PPP interface (PPP 0) to the factory answering defaults.

A rectangular button with a light gray background and a thin border. The text "Load answering defaults" is centered on the button in a dark gray font.**Description**

A memorable name for this PPP instance, to make it easier to identify it.

Only accept calls from calling numbers

ending with

Restricts the range of numbers from which ISDN will answer incoming calls, such as the ISDN interface will only answer a call if the trailing digits of the calling number match what is specified by this parameter. For example, if this parameter was set to **3**, incoming calls from **1234563** would be answered but calls from **1234567** would not.

with ISDN MSN ending with**If answering is disabled this parameter is not used.**

Provides the filter for the ISDN Multiple Subscriber Numbering facility. It is blank by default but when set to an appropriate value on an answering interface, it will cause the router to answer incoming calls to only telephone numbers where the trailing digits match the value selected.

For example, setting this parameter to **123** will prevent the router from answering any calls to numbers that do not end in **123**.

with ISDN sub-address ending with**If answering is disabled this parameter is not used.**

Provides the filter for the ISDN sub-address facility. It is blank by default but when set to an appropriate value on an ISDN answering interface, it will cause the router to answer incoming calls only to ISDN numbers where the trailing digits match the Sub-address value. For example, setting the this parameter to **123** will prevent the router from answering any calls to numbers that do not end in **123**.

Use the following local IP configuration**Local IP Address:**

The IP address of the router's ISDN answering interface. Set this field to the desired local IP address.

Attempt to assign the following IP configuration to remote devices

Set this parameter if the remote system needs a supplied address. The interface makes an attempt to negotiate an IP address from the IP address pool. Generally, this parameter is enabled for incoming connections. When enabled, displays the following parameters:

Assign remote IP addresses from a.b.c.d to a.b.c.d

The range of IP addresses supplied to incoming callers. This parameter may require alteration if the default value **10.10.10.0** to **10.10.10.4** does not suit the remote network configuration.

Mask

The IP netmask for the Remote network. Use this setting to create a dynamic route to the remote network whenever the ISDN interface is active.

Primary DNS server

The answering ISDN interface would normally supply its own PPP IP address to the peer for DNS requests. This parameter allows you to specify an alternative DNS IP address.

Secondary DNS server

A secondary DNS server IP address to the peer for DNS requests, if required.

Enable NAT on this interface

Enables or disables IP Network Address Translation (NAT) on the answering ISDN interface. When enabled, displays the following options:

IP Address

Enable standard Network Address Translation (NAT).

IP address and Port

Enable Network Address and Port Translation (NAPT).

Enable IPsec on this interface

Enables or disables IPsec processing on the ISDN interface. If enabled, packets sent or received on this interface must pass through the IPsec code before being transmitted. IPsec may drop the packet, pass it unchanged, or encrypt and encapsulate within an IPsec packet. When enabled, displays the following parameters:

Keep Security Associations (SAs) when this ISDN interface is disconnected

Configures the router to keep any existing IKE and IPsec associations should the link drop. This is usually applied on head-end routers with fixed IP addresses.

Use interface X, Y for the source IP address of IPsec packets

By default, the source IP address for an IPsec Eroute is the IP address of the interface on which IPsec was enabled. By setting this parameter to either a PPP or Ethernet interface, the source IP address IPsec uses will match that of the specified Ethernet or PPP interface.

Enable the firewall on this interface

Enables or disables the Firewall script processing for the mobile interface.

Note If the firewall is enabled on an interface and with the absence of any firewall rules, the default action is to block ALL traffic. To configure the firewall, see [Firewall](#).

3. Click **Apply**.

 **Command line**

Command	Instance	Parameter	Values	Equivalent web parameter
ppp	0	name	Free text field	Description:
ppp	0	cingnb	number	ending with
ppp	0	msn	number	with ISDN MSN ending with
ppp	0	sub	number	with ISDN sub-address ending with
ppp	0	ipaddr	IP address	Local IP Address:
ppp	0	mask	Network mask	Mask:
ppp	0	ipmin	IP address	Assign remote IP addresses from a.b.c.d to a.b.c.d
ppp	0	iprange	1-255	Assign remote IP addresses from a.b.c.d to a.b.c.d
ppp	0	dnsserver	IP address	Primary DNS server:
ppp	0	secdns	IP address	Secondary DNS server:
ppp	0	do_nat	1	Enable NAT on this interface IP Address:
ppp	0	do_nat	2	Enable NAT on this interface IP address and Port:
ppp	0	ipsec	1	Enable IPsec on this interface
ppp	0	ipsec	2	Keep Security Associations (SAs) when this ISDN interface is disconnected
ppp	0	ipsecent	Default,Ethernet,PPP	Use interface X, Y for the source IP address of IPsec packets
ppp	0	ipsecadd	number	Use interface X, Y for the source IP address of IPsec packets
ppp	0	firewall	on/off	Enable the firewall on this interface

Configure ISDN dialing parameters

Web

1. Go to **Configuration > Network > Interfaces > ISDN > ISDN Dialling**. When the router is first powered up, navigating to the **Configuration > Network > Interfaces > ISDN** page displays a message indicating that the MODEM card does not have a PPP instance associated with it. Follow the link on the page and select an unassigned PPP interface to the MODEM. When the browser is refreshed and the **Configuration > Network > Interfaces > ISDN** page redisplayed, it should show the parameters described below, along with a message at the top of the page indicating which PPP instance has been selected.
2. Configure ISDN dialing parameters:

This ISDN interface is using PPP n

This message simply states which PPP instance has been assigned to the interface.

Description

A memorable name for the interface. This may be useful when referring to the interface, rather than having to remember the name and the function of the interface.

Dial out using numbers

The telephone numbers to use to make an outgoing connection, in sequence.

Prefix n to the dial out number

The dialing prefix to use, if needed. This may be necessary when using a PABX.

Username

The username to use when using the PPP instance to connect to the remote peer. This username is normally provided by an ISP for use with a dial-in Internet access service.

Password

The password to use for authenticating the remote peer, along with the above **username**.

Confirm password

Type the password into this text box to enable the router to confirm that the password has been entered identically in both boxes.

Allow the remote device to assign a local IP address to this router

When this radio button is selected, the remote peer will assign this PPP interface an IP address.

Try to negotiate a.b.c.d as the local IP address for this router

If it would be useful, but not essential, to have a predefined IP address for the interface, the second radio button should be selected and the desired IP address entered into the text box to the right.

Use a.b.c.d as the local IP address for this router

If it is essential that the PPP interface has a specific IP address, this radio button should be selected and the IP address entered into the text box.

Use the following DNS servers if not negotiated**Primary DNS server**

The IP address of the primary DNS server to use if a DNS server is not assigned as part of the PPP negotiation and connection process. It is fairly common practice for the DNS server to be assigned automatically by the ISP when making a connection.

Secondary DNS server

The IP address of the secondary DNS server to use if one is not automatically assigned by the remote peer.

Attempt to assign the following IP configuration to remote devices

When checked, this check box reveals the following four configuration parameters which control how the PPP instance assigns an IP address to a connecting remote peer. The primary and secondary DNS server addresses will also be sent to the remote peer

Assign remote IP addresses from a.b.c.d to a.b.c.d

The IP addresses that define the pool of IP addresses to assign to remote peers during the IP protocol configuration phase of the PPP negotiation process.

Primary DNS server

The IP address of the primary DNS server that the remote peer should use when making DNS requests over the link.

Secondary DNS server

The IP address of the secondary DNS server that the remote peer should use when making DNS requests, should the primary server be unavailable.

Allow the PPP interface to answer incoming calls

When enabled, causes the PPP instance to answer an incoming call.

Only allow calling numbers ending with n

When set to answer calls, this setting provides a filter for ISDN sub-addresses. This value is blank by default but when the PPP instance is set to answer calls, only numbers having trailing digits that match the sub-address value in this test will be answered. So for example, if this value is set to **123**, only calls from numbers with trailing digits that match this value will be answered; for example, **01942 605123**.

Enable NAT on this interface

Enables Network Address Translation to operate on this interface. This is the same as for other PPP interfaces.

IP address/IP address and Port

Whether IP address translation only should be applied or whether port number translation should also be applied to IP packets.

Enable IPsec on this interface

When enabled, causes the router to encrypt traffic on this interface using the IPsec protocol. The following two additional configuration parameters are revealed when this box is checked.

Keep Security Associations (SAs) when this ISDN interface is disconnected

When enabled, causes the router to maintain (such as not flush) the SA when the interface becomes disconnected. The normal behavior is to remove the SAs when the interface becomes disconnected.

Use interface x,y for the source IP address of IPsec packets

If it is required to use another interface (such as not the interface currently being configured) as the source address for IPsec packets, this may be achieved by selecting the desired interface from the drop-down list and typing the desired interface instance number into the adjacent text box.

Enable the firewall on this interface

When enabled, applies the firewall rules to traffic using this interface.

3. Click **Apply**.



Command line

Command	Instance	Parameter	Values	Equivalent web parameter
ppp	n	name	Up to 25 characters	Description
ppp	n	phonenum	up to 25 digits	Dial out using numbers
ppp	n	ph2	“	“
ppp	n	ph3	“	“
ppp	n	ph4	“	“
ppp	n	prefix	0-9999999999	Prefix n to the dial out number
ppp	n	username	Up to 60 characters	Username
ppp	n	password	Up to 40 characters	Password
ppp	n	IPaddr	0.0.0.0	Allow the remote device to assign a local IP address to this router

Command	Instance	Parameter	Values	Equivalent web parameter
ppp	n	IPaddr	Valid IP address a.b.c.d	Try to negotiate a.b.c.d as the local IP address for this router (in conjunction with L_addr)
ppp	n	L_addr	off, on When on, allows negotiation When off , forces use of specified IP address	Use a.b.c.d as the local IP address of this router
ppp	n	DNSserver	Valid IP address a.b.c.d	Use the following DNS servers if not negotiated Primary DNS server a.b.c.d
ppp	n	secDNS	Valid IP address a.b.c.d	Use the following DNS servers if not negotiated Secondary DNS server a.b.c.d
ppp	n	IPmin	Valid IP address a.b.c.d	Assign remote IP addresses from a.b.c.d to a.b.c.d
ppp	n	IPrange	0-255	Assign remote IP addresses from a.b.c.d to a.b.c.d
ppp	n	transDNS	Valid IP address a.b.c.d	Primary DNS server a.b.c.d
ppp	n	sectransDNS	Valid IP address a.b.c.d	Secondary DNS server a.b.c.d
ppp	n	ans	off, on	Allow this PPP interface to answer incoming calls
ppp	n	cingnb	up to 25 digits	Only allow calling numbers ending with n
ppp	n	do_nat	0, 1, 2 0=Disabled 1=IP address 2=IP address and port	Enable NAT on this interface IP address/IP address and Port
ppp	n	nat_ip	Valid IP address a.b.c.d	NAT Source IP address a.b.c.d

Command	Instance	Parameter	Values	Equivalent web parameter
ppp	n	ipsec	0=Disabled 1=Enabled 2=Enabled and Keep SAs	Enable IPsec on this interface/ Keep Security Associations when this ISDN interface is disconnected
ppp	n	firewall	off, on	Enable the firewall on this interface

Configure advanced ISDN parameters

Web

1. Go to **Configuration > Network > Interfaces > ISDN > Advanced**
2. Configure advanced ISDN parameters as needed:

Metric

The route metric that should be applied to this interface. For details, see [Configure PPP parameters](#).

Enable “Always On” mode of this interface

When enabled, causes the following two options to appear.

On/On and return to service immediately

These two radio buttons select whether the **always-on** functionality should simply be enabled or whether the additional facility to return the interface to the **In Service** state should be applied.

Put this interface “Out of Service” when an always-on connection attempt fails

Normally, always-on interfaces do not go out of service unless they have connected at least once. When enabled, causes the router to put the interface out of service even if the first connection attempt fails.

Attempt to re-connect after s seconds

Specifies the length of time in seconds that the router should wait after an always-on PPP connection has been terminated before trying to re-establish the link.

If an inhibited PPP interface is connected, attempt to re-connect after s seconds

The value in this setting takes precedence over the previous parameter when another PPP instance that is usually inhibited by this one is connected. This parameter typically reduces the connection retry rate when a lower priority PPP instance is connected.

Wait s seconds after power-up before activating this interface

The initial delay that the router applies before activating the PPP instance after power-up. After the initial power-up delay the normal always-on activation timers apply. If set to **0**, no delay will be applied.

Control when this interface can connect using Time band n

Enables the time band function and allows selecting the desired time band instance. See [Configuring time bands](#) for more information on time bands.

Keep this interface up for at least s seconds

The minimum period that the PPP interface should remain available. This means that even if the link becomes inactive before this period expires, the connection will remain open.

Close this interface**After s seconds**

The maximum time that the link remains active in any one session. After this time, the link will be deactivated.

If it has been up for m minutes in a day

The router deactivates the PPP instance after it has been active for the value specified in this text box.

If the link has been idle for s seconds

The router deactivates this interface after the time specified in this text box if it detects that the link has not passed any traffic for that period.

Alternative idle timer for static routes s seconds

An alternative inactivity timeout for use in conjunction with the **Make PPP n interface use the alternative idle timeout when this route becomes available** parameter on the **Configuration > Network > IP Routing/Forwarding > Static Routes > Routes n > Advanced** web page. The router uses timeout until the PPP instance next deactivates only. After that, it uses the normal timeout value.

If the link has not received any packets for s seconds

The amount of time that the router will wait without receiving any PPP packets before disconnecting. The timer is reset with each received PPP packet.

If the negotiation is not complete in s seconds

The maximum time (in seconds) allowed for the PPP negotiation to complete. If negotiations have not completed within this period, the interface is deactivated.

Generate an event after this interface has been up for m minutes

The number of minutes (if any) after which the router should create an event in the event log that states that the interface has been active for this period.

Limit the data transmitted over this interface

When enabled, displays the following parameters that control any data volume restrictions that should be applied to this interface.

Issue a warning event after n units

The amount of traffic which causes a warning event to be generated in the event log stating that the specified amount of data has been transferred. The units are specified by a drop-down list, having the options kilobytes, megabytes, gigabytes. For example, if the monthly tariff includes up to 5 MB of data before excess usage charges are levied, it would be useful to set this threshold to 4 MB. This would cause the router to create a warning entry in the event log once 4 MB of data had been transferred. You could use this event to trigger an email alert, SNMP trap or SMS alert message.

Stop data from being transmitted after n units

The total amount of data that may be transmitted by this PPP instance before the link is blocked for further traffic, and the value in the drop-down list specifies the units which are **kilobytes, megabytes, gigabytes**.

Reset the data limit on the n day of the month

The day of the month on which the data limit is reset to 0.

3. Click **Apply**.

**Command line**

Command	Instance	Parameter	Values	Equivalent web parameter
ppp	n	metric	0-255	Metric
ppp	n	aodion	0-2 0=disabled 1=enabled 2=On and return to service immediately	Enable "Always On" mode of this interface, On, On and return to service immediately
ppp	n	immoos	on, off	Put this interface "Out of Service" when an always-on connection attempt fails
ppp	n	aodi_dly	0-2147483647	Attempt to reconnect after s seconds
ppp	n	aodi_dly2	0-2147483647	If an inhibited PPP interface is connected, attempt to re-connect after s seconds
ppp	n	pwr_dly	0-2147483647	Wait s seconds after power-up before activating this interface
ppp	n	tband	0-4	Control when this interface can connect using Time Band n
ppp	n	minup	0-2147483647	Keep this interface up for at least s seconds
ppp	n	maxup	0-2147483647	Close this interface after s seconds
ppp	n	maxuptime	0-2147483647	if it has been up for m minutes in a day
ppp	n	timeout	0-2147483648	if the link has been idle for s seconds
ppp	n	timeout2	0-2147483648	Alternative idle timer for static routes s seconds
ppp	n	rxtimeout	0-2147483648	if the link has not received any packets for s seconds

Command	Instance	Parameter	Values	Equivalent web parameter
ppp	n	maxneg	0-2147483648	if the negotiation is not complete in s seconds
ppp	n	uplogmins	0-2147483647	Generate an event after this interface has been up for m mins
ppp	n	dlwarnkb	0-2147483647	Issue a warning after n units
ppp	n	dlstopkb	0-2147483647	Stop data from being transmitted after n units
ppp	n	dlrstday	0-255	Reset the data limit on the n day of the month

Configure ISDN Link Access Protocol D (LAPD) parameters

Link Access Protocol D (LAPD) is the protocol for ISDN D-channel signaling and call setup. You can use **LAPD 0** and **LAPD 1** as required for SAPI 16 traffic, such as X.25 over D-channel. **LAPD 2** is normally reserved for ISDN call control.

Web

1. Go to **Configuration > Network > Interfaces > ISDN > LAPD**. The **ISDN LAPD parameters** page configures the ISDN LAPD interfaces.
2. Configure LAPD interface parameters:

Enable LAPD n

Disabling this parameter disables the LAPD instance. This may be necessary if you have an installation where two or more routers are connected to the same ISDN **S** bus. In this case, only one of the routers may be configured for D-channel X.25 on TEI1, SAPI16. On each of the other routers you must disable any LAPD instance for which the TEI is set to 1 in order to prevent it from responding to X.25 traffic on that TEI that is actually destined for another router.

When checked, this check box will also reveal the following configuration parameters.

Mode

When the DTE/DCE mode parameter is set to DTE, the router behaves as a DTE. This is the default value and should not be changed for normal operation across the ISDN network. If your application involves using two routers back-to-back, one of the routers should have the DTE mode value set to DCE.

N400 Counter

The standard LAPB/LAPD retry counter. The default value is **3** and it should not normally be necessary to change this.

RR Timer n msec

The standard LAPB/LAPD Receiver Ready timer. The default value is **10,000ms (10 seconds)** and it should not normally be necessary to change this.

T1 Timer n msec

The standard LAPB/LAPD timer. The default value is **1000** milliseconds (**1** second) and it should not normally be necessary to change this.

T200 Timer n msec

The standard LAPB/LAPD re-transmit timer, in milliseconds. The default value is **1000** milliseconds (**1** second) and it should not normally be necessary to change this.

TEI

Each ISDN terminal device connected to your ISDN basic rate outlet must be assigned a unique Terminal Endpoint Identifier (TEI). In most cases, this is negotiated automatically. In some cases however, it may be necessary to assign a fixed TEI.

When TEI is set to **255**, the TEI is negotiated with the ISDN network. To use a fixed TEI set the TEI parameter to the appropriate value as specified by your service provider.

D-channel X.25 Tx Window Size

The transmit window size when using D-channel X.25. The default is **7**.

Tx Throughput

Used in conjunction with the **Rx Throughput** parameter to limit the maximum data throughput on a LAPD link in bits per second.

If this parameter is set to **0**, the router will transmit data across the LADP link as fast as possible whilst observing hardware or software flow control if enabled.

When set to a value greater than **0**, the router will limit the rate at which data is transmitted over the LAPD link.

Note If multiple PAD or IP instances are sharing this LAPD instance, the maximum transmission rates of all instances will be limited.

Rx Throughput

Used in conjunction with the **Tx Throughput** parameter to limit the maximum data throughput on a LAPD link in bits per second.

If this parameter is set to **0**, the router will transmit data across the LADP link as fast as possible whilst observing hardware or software flow control if enabled.

When set to a value greater than **0**, the router will limit the rate at which data can be received over the LAPD link when it detects that receive throughput exceeds the specified rate.

Note If multiple PAD or IP instances are sharing this LAPD instance, the maximum transmission rates of all instances will be limited.

Reactivate D-channel connection

When enabled, the router tries to reactivate a D-channel connection after disconnection by the network by transmitting SABME frames. If it is unable to reactivate the connection after retrying the number of times specified by the **N400** counter, it will wait for **1** minute before repeating the retry sequence.

Enabling this parameter also deactivates the **Reactivate after n secs** parameter.

If this parameter is disabled, the router will not attempt to reactivate a D-channel link following deactivation by the network.

Reactivate after n secs

The number of seconds a deactivation has to be present before the LAPD instance will try to reactivate itself.

After X.25 PAD session is terminated

Determines whether the LAPD session is deactivated when an X.25 PAD session is terminated.

Deactivate the LAPD session

Enables automatic deactivation of a LAPD session when an X.25 PAD session is terminated.

Do not deactivate the LAPD session

Ensures the router does not deactivate the LAPD session when an X.25 PAD session is terminated.

Enable D64S Mode

D64S mode is a mode for using ISDN B-channel(s) without the need to use any D channel protocol. It is sometimes referred to as nailed-up ISDN. To enable this mode for this LAPD instance, enable the **D64S mode** parameter, and make sure the **TEI** parameter is set to **255**. This means that for any application that uses ISDN (such as PPP) the application uses **D64S** mode.

First D64S B-channel

When using D64S mode, there is no dialing protocol to negotiate which B-channel to use. This must therefore be specified using this parameter. Check the **B1** radio button to select channel **B1**. Check the **B2** radio button to select channel **B2** (if another channel is requested from an application then it will use the other unused B channel).

3. Click **Apply**.



Command line

Command	Instance	Parameter	Values	Equivalent web parameter
LAPD	n	enabled	off, on	Enable LAPD n
LAPD	n	dtemode	off, on	Mode
LAPD	n	n400	1-255	N400 Counter
LAPD	n	tnoact	1000-60000	RR Timer n msec
LAPD	n	t1time	1-60000	T1 Timer n msec
LAPD	n	t200	1-60000	T200 Timer n msec
LAPD	n	tei	0-255	TEI
LAPD	n	window	1-7	D-channel X.25 Tx Window Size
LAPD	n	tthruput	0-1410065407	Tx Throughput
LAPD	n	rthruput	0-1410065407	Rx Throughput
LAPD	n	keepact	off, on	Reactivate D-channel connection
LAPD	n	reactsecs	0-2147483647	Reactivate after n secs
LAPD	n	nodeact	off	After X.25 PAD session is terminated: Deactivate the LAPD session
LAPD	n	nodeact	on	After X.25 PAD session is terminated: Do not deactivate the LAPD session
LAPD	n	d64smode	off, on	Enable D64S Mode
LAPD	n	d64schan	1, 2	First D64S B-channel: B1, B2

Configure ISDN to answer V.120 calls

V.120 is a protocol designed to provide high-speed point-to-point communication over ISDN. It provides rate adaptation and can optionally provide error control. Both the calling and called routers must be configured to use V.120 before data can be transferred. Similarly, if one router is configured to use the error control facility, the other must be configured in the same way.

Initial setup

Before using V.120 you must first bind one of the two available V.120 instances to the required ASY port.

Web

1. Go to **Configuration > Network > Interfaces > Serial > Protocol Bindings** and bind one of the V.120 instances to the ASY port. See [Configure protocol bindings](#) for more information about these settings.
2. Select the appropriate method of flow control for the ASY port. Go to **Configuration > Network > Interfaces > Serial > Serial Port n**.

Command line

1. Use the **bind** command; for example:

```
bind v120 0 asy 0
```

2. Use the **AT&K** command to configure flow control for the ASY port. Configure other ASY port options such as command echo, result code format, etc. as needed.

Initiating a V.120 call

Command line

Once the initial configuration is complete, initiate V.120 calls using the appropriate **ATD** command. For example:

```
atd01234567890
```

A successful connection is indicated by a **CONNECT** result code being issued to the **ASY** port, and the router will switch into on-line mode. In this mode, all data from the terminal attached to the bound **ASY** port is passed transparently through the router across the ISDN network to the remote system. Similarly, all data from the remote system is passed directly to the terminal attached to the bound **ASY** port.

If a V.120 call fails the router will issue the **NO ANSWER** or **NO CARRIER** result code to the **ASY** port and remain in command mode.

You can use the **ATD** command to route a call to an ISDN sub-address by following the telephone number with the letter S and the required sub-address value. For example:

```
atd01234567890s003
```

In this case, the remote system only answers the call if it was configured to accept incoming calls on the specified sub-address.

Answering V.120 calls



Command line

To enable V.120 answering from the command interface, set register **S0** for the appropriate **ASY** port to a non-zero value. For example:

```
ats0=1
```

To ensure that you have set **S0** for the correct **ASY** port, either enter it directly on that port or use the **AT\PORT** command to select the correct port first.

The actual value for the parameter sets the number of rings the router will wait before answering.

Finally, you must ensure that there are no conflicts with other protocols configured to answer on other **ASY** ports. To do this, disable answering for the other ports/protocols or by using the MSN and/or Sub-address parameters to selectively answer calls to different telephone numbers using different protocols.

For example, if you have subscribed to the ISDN MSN facility, you may have been allocated say four telephone numbers ending in **4**, **5**, **6**, and **7**. You could then set the MSN parameter for the appropriate V.120 instance to **4** to configure V.120 to answer only incoming calls to the MSN number ending in **4**.

If PPP answering is enabled, verify that you have **not** selected the same MSN and Sub-address values for PPP. If they are the same, V.120 will answer the call **only** if **S0** is set to **1**. Otherwise, PPP will take priority and answer the call.

Configure PSTN interfaces

These settings apply to TransPort routers fitted with an optional internal PSTN MODEM card.

Web

1. Go to **Configuration > Network > Interfaces > PSTN**.
2. When the router is first powered up, this page shows a message indicating that the MODEM card does not have a PPP instance associated with it. Follow the link on the page and select an unassigned PPP interface to the MODEM.
3. Refresh your browser and go to **Configuration > Network > Interfaces > PSTN**. The page should show the following parameters, along with a message at the top of the page indicating the selected PPP instance. Configure these parameters as needed:

This PSTN interface is using PPP n

Which PPP instance has been assigned to the interface.

Description

A memorable name for the PSTN interface. This may be useful when referring to the interface, rather than having to remember the name and the function of the interface.

Dial out using numbers

The telephone numbers to make an outgoing connection, in sequence.

Prefix n to the dial out number

The dialing prefix to use, if needed. This may be necessary when using a PABX.

Username

The username to use when using the PPP instance to connect to the remote peer. This is normally provided by an ISP for use with a dial-in Internet access service.

Password

The password to use for authenticating the remote peer, along with the above **username**.

Confirm password

Type the password into this text box to enable the router to confirm that the password was entered identically in both boxes.

Allow the remote device to assign a local IP address to this router

When selected, the remote peer assigns this PPP interface an IP address.

Try to negotiate a.b.c.d as the local IP address for this router

If it is useful essential to have a predefined IP address for the interface, select the second radio button and enter the desired IP address into the text box to the right. This field is optional.

Use a.b.c.d as the local IP address for this router

If it is essential that the PPP interface has a specific IP address, select this radio button and the IP address entered into the text box.

Use the following DNS servers if not negotiated**Primary DNS server**

The IP address of the primary DNS server to use if a DNS server is not assigned as part of the PPP negotiation and connection process. It is fairly common practice for the DNS server to be assigned automatically by the ISP when making a connection.

Secondary DNS server

The IP address of the secondary DNS server to use if one is not automatically assigned by the remote peer.

Attempt to assign the following IP configuration to remote devices

When enabled, reveals the following four configuration parameters which control how the PPP instance assigns an IP address to a connecting remote peer. The primary and secondary DNS server addresses are also sent to the remote peer

Assign remote IP addresses from a.b.c.d to a.b.c.d

The pool of IP addresses to assign to remote peers during the IP protocol configuration phase of the PPP negotiation process.

Primary DNS server

The IP address of the primary DNS server that the remote peer should use when making DNS requests over the link.

Secondary DNS server

The IP address of the secondary DNS server that the remote peer should use when making DNS requests, should the primary server be unavailable.

Allow the PPP interface to answer incoming calls

When enabled, causes the PPP instance to answer an incoming call.

Only allow calling numbers ending with n

When set to answer calls, the value in this text box provides a filter for ISDN sub-addresses. This value is blank by default but when the PPP instance is set to answer calls, only numbers having trailing digits that match the sub-address value in this test will be answered. So for example, if this value is set to **123**, only calls from numbers with trailing digits that match this value will be answered; for example, **01942 605123**.

Enable NAT on this interface

When enabled, enables Network Address Translation to operate on this interface. This is the same as for other PPP interfaces.

IP address/IP address and Port

Select whether IP address translation only should be applied or whether port number translation should also be applied to IP packets.

Enable IPsec on this interface

When enabled, causes the router to encrypt traffic on this interface using the IPsec protocol. The following two additional configuration parameters are revealed when this box is checked.

Keep Security Associations (SAs) when this PSTN interface is disconnected

When enabled, causes the router to maintain (such as not flush) the SA when the interface becomes disconnected. The normal behavior is to remove the SAs when the interface becomes disconnected.

Use interface x,y for the source IP address of IPsec packets

If it is required to use another interface (such as not the interface currently being configured) as the source address for IPsec packets, this may be achieved by selecting the desired interface from the drop-down list and typing the desired interface instance number into the adjacent text box.

Enable the firewall on this interface

When enabled, applies the firewall rules to traffic using this interface.

4. Click **Apply**.

 **Command line**

Command	Instance	Parameter	Values	Equivalent web parameter
ppp	n	name	Up to 25 characters	Description
ppp	n	phonenum	up to 25 digits	Dial out using numbers
ppp	n	ph2	“	“
ppp	n	ph3	“	“
ppp	n	ph4	“	“
ppp	n	prefix	0-9999999999	Prefix n to the dial out number
ppp	n	username	Up to 60 characters	Username
ppp	n	password	Up to 40 characters	Password

Command	Instance	Parameter	Values	Equivalent web parameter
ppp	n	IPaddr	0.0.0.0	Allow the remote device to assign a local IP address to this router
ppp	n	IPaddr	Valid IP address a.b.c.d	Try to negotiate a.b.c.d as the local IP address for this router (in conjunction with l_addr)
ppp	n	l_addr	off, on When on, allows negotiation when off , force use of specified IP address	Use a.b.c.d as the local IP address of this router
ppp	n	DNSserver	Valid IP address a.b.c.d	Use the following DNS servers if not negotiated Primary DNS server a.b.c.d
ppp	n	secDNS	Valid IP address a.b.c.d	Use the following DNS servers if not negotiated Secondary DNS server a.b.c.d
ppp	n	IPmin	Valid IP address a.b.c.d	Assign remote IP addresses from a.b.c.d to a.b.c.d
ppp	n	IPrange	0-255	Assign remote IP addresses from a.b.c.d to a.b.c.d
ppp	n	transDNS	Valid IP address a.b.c.d	Primary DNS server a.b.c.d
ppp	n	sectransDNS	Valid IP address a.b.c.d	Secondary DNS server a.b.c.d
ppp	n	ans	off, on	Allow this PPP interface to answer incoming calls
ppp	n	cingnb	up to 25 digits	Only allow calling numbers ending with n
ppp	n	do_nat	0, 1, 2 0=Disabled 1=IP address 2=IP address and port	Enable NAT on this interface IP address/IP address and Port
ppp	n	nat_ip	Valid IP address a.b.c.d	NAT Source IP address a.b.c.d

Command	Instance	Parameter	Values	Equivalent web parameter
ppp	n	ipsec	0=Disabled 1=Enabled 2=Enabled and Keep SAs	Enable IPsec on this interface/ Keep Security Associations when this PSTN interface is disconnected
ppp	n	firewall	off, on	Enable the firewall on this interface

Configure advanced PSTN parameters

Web

1. Go to **Configuration > Network > Interfaces > PSTN > Advanced**.
2. Configure advanced PSTN parameters as needed:

Metric

The route metric that should be applied to this interface. See [Configure PPP parameters](#) for more detail.

Enable “Always On” mode of this interface

When enabled, causes the following two options to appear.

On/On and return to service immediately

Select whether the always-on functionality should simply be enabled or whether the additional facility to return the interface to the In Service state should be applied.

Put this interface “Out of Service” when an always-on connection attempt fails

Normally, always-on interfaces do not go out of service unless they have connected at least once. When enabled, causes the router to put the interface out of service even if the first connection attempt fails.

Attempt to re-connect after s seconds

The length of time in seconds that the router should wait after an always-on PPP connection has been terminated before trying to re-establish the link.

If an inhibited PPP interface is connected, attempt to re-connect after s seconds

The value in this text box takes precedence over the previous parameter when another PPP instance that is usually inhibited by this one is connected. Use this parameter to reduce the connection retry rate when a lower priority PPP instance is connected.

Wait s seconds after power-up before activating this interface

The initial delay that the router applies before activating the PPP instance after power-up. After the initial power-up delay the normal always-on activation timers apply. If set to **0**, no delay is applied.

Control when this interface can connect using Time band n

These two controls, the check box and drop-down list, determine whether the time band function should be applied to this interface. Enabling this setting enables the functionality and the desired time band instance is selected from the drop-down list. See [Configuring time bands](#) for more information about the time band function.

Keep this interface up for at least s seconds

The minimum period that the PPP interface should remain available. This means that even if the link becomes inactive before this period expires, the connection remains open.

Close this interface**After s seconds**

The maximum time that the link remains active in any one session. After this time, the link is deactivated.

If it has been up for m minutes in a day

The router deactivates the PPP instance after it has been active for the value specified in this text box.

If the link has been idle for s seconds

The router deactivates this interface after the time specified in this text box if it detects that the link has not passed any traffic for that period.

Alternative idle timer for static routes s seconds

An alternative inactivity timeout for use in conjunction with the **Make PPP n interface use the alternative idle timeout when this route becomes available** parameter on the **Configuration > Network > IP Routing/Forwarding > Static Routes > Routes n > Advanced** page. The router uses this timeout until the PPP instance next deactivates only. After that, it uses the normal timeout value.

If the link has not received any packets for s seconds

The amount of time that the router will wait without receiving any PPP packets before disconnecting. The timer is reset with each received PPP packet.

If the negotiation is not complete in s seconds

The maximum time, in seconds, allowed for the PPP negotiation to complete. If negotiations have not completed within this period, the interface is deactivated.

Generate an event after this interface has been up for m minutes

The number of minutes, if any, after which the router should create an event in the event log that states that the interface has been active for this period.

Limit the data transmitted over this interface

When enabled, displays the following parameters that control what data volume restrictions (if any) should be applied to this interface.

Issue a warning event after n units

The amount of traffic that causes a warning event to be generated in the event log stating that the specified amount of data has been transferred. The units are specified by a drop-down list, with the options of kilobytes, megabytes, gigabytes. For example, if the monthly tariff includes up to **5** MB of data before excess usage charges are levied, it is useful to set this threshold to **4** MB. This would cause the router to create a warning entry in the event log once **4** MB of data is transferred. You could use this event to trigger an email alert, SNMP trap, or SMS alert message.

Stop data from being transmitted after n units

The total amount of data transmitted by this PPP instance before the link is blocked for further traffic. The value in the drop-down list specifies the units: **kilobytes**, **megabytes**, or **gigabytes**.

Reset the data limit on the n day of the month

The day of the month on which the data limit is reset to 0.

3. Click **Apply**.

**Command line**

Command	Instance	Parameter	Values	Equivalent web parameter
ppp	n	metric	0-255	Metric
ppp	n	aodion	0-2 0=disabled 1=enabled 2=On and return to service immediately	Enable “Always On” mode of this interface, On, On and return to service immediately
ppp	n	immoos	on, off	Put this interface “Out of Service” when an always-on connection attempt fails
ppp	n	aodi_dly	0-2147483647	Attempt to reconnect after s seconds
ppp	n	aodi_dly2	0-2147483647	If an inhibited PPP interface is connected, attempt to re-connect after s seconds
ppp	n	pwr_dly	0-2147483647	Wait s seconds after power-up before activating this interface
ppp	n	tband	0-4	Control when this interface can connect using Time Band n
ppp	n	minup	0-2147483647	Keep this interface up for at least s seconds
ppp	n	maxup	0-2147483647	Close this interface after s seconds
ppp	n	maxuptime	0-2147483647	if it has been up for m minutes in a day
ppp	n	timeout	0-2147483648	if the link has been idle for s seconds
ppp	n	timeout2	0-2147483648	Alternative idle timer for static routes s seconds
ppp	n	rxtimeout	0-2147483648	if the link has not received any packets for s seconds
ppp	n	maxneg	0-2147483648	if the negotiation is not complete in s seconds

Command	Instance	Parameter	Values	Equivalent web parameter
ppp	n	uplogmins	0-2147483647	Generate an event after this interface has been up for m mins
ppp	n	dlwarnkb	0-2147483647	Issue a warning after n units
ppp	n	dlstopkb	0-2147483647	Stop data from being transmitted after n units
ppp	n	dlrstday	0-255	Reset the data limit on the n day of the month

Configure DialServ interfaces

The Dialserv option module mimics a telephone exchange in that it supplies the required voltages on the line, generates a **RING** signal and has off-hook detection circuitry. You can use Dialserv to provide similar functionality to dialing into an ISP using an analogue modem. The card also contains an analog modem to handle data on the line.

Web

1. Go to **Configuration > Network > Interfaces > DialServ**.
2. Configure DialServ parameters:

Use PPP/Protocol Switch

These radio buttons select whether the DialServ card uses a PPP instance or the protocol switch functionality to control traffic on the interface. If **PPP** is selected, the web page expands to display the standard PPP configuration settings. If **Protocol Switch** is selected, only the four settings described immediately below are visible.

Max time to RING line s seconds

The maximum number of seconds that the **RING** signal should be generated for.

RING frequency n Hz

The DialServ module generates a **RING** signal. The frequency of the **RING** is selected from this drop-down list. The available options are:

- 20Hz
- 25Hz
- 30Hz
- 40Hz
- 50Hz

Initialisation string 1

The text string in this text box contains any required modem initialization commands.

Initialisation string 2

The text string in this text box contain initialization commands that will be issued to the modem after the first initialization string.

3. Click **Apply**.

Configure DialServ network settings

Web

1. Go to **Configuration > Network > Interfaces > DialServ > DialServ Network Settings**.
2. You can configure the DialServ card to use PPP as the protocol to connect to the remote peer and as such should be assigned a free PPP instance to use as part of the configuration. If no PPP instance has been assigned and the module has been configured to use PPP, a link to the PPP mappings page and message appear. If a PPP instance has been assigned, the following DialServ network settings appear. Configure these settings as needed:

This DialServ interface is using PPP n

The PPP instance (n) the DialServ card uses.

Description

A short string that describes the interface, which you can use as a convenience when referring to the interface.

Dial out using numbers

The telephone numbers to use in making an outgoing connection, in sequence. Use these numbers to provide a dialback facility.

Prefix n to the dial out number

The dialing prefix to use, if needed. This may be necessary when using a PABX.

Username

The username to use when using the PPP instance to connect to the remote peer.

Password

The password to use for authenticating the remote peer; specified in conjunction with the **Username**.

Confirm Password

Type the password into this text box to enable the router to confirm that the password has been entered identically in both boxes.

Allow the remote device to assign a local IP address to this router

When this radio button is selected, the remote peer will assign this PPP interface an IP address.

Try to negotiate a.b.c.d as the local IP address for this router

If it would be useful, but not essential, to have a predefined IP address for the interface, the second radio button should be selected and the desired IP address entered into the text box to the right.

Use a.b.c.d as the local IP address for this router

If it is essential that the PPP interface has a specific IP address, this radio button should be selected and the IP address entered into the text box.

Use the following DNS servers if not negotiated**Primary DNS server**

The IP address of the primary DNS server to use if a DNS server is not assigned as part of the PPP negotiation and connection process. It is fairly common practice for the DNS server to be assigned automatically by the ISP when making a connection.

Secondary DNS server

The IP address of the secondary DNS server to use if one is not automatically assigned by the remote peer.

Attempt to assign the following IP configuration to remote devices

When enabled, displays the following four configuration parameters that control how the PPP instance assigns an IP address to a connecting remote peer. The primary and secondary DNS server addresses will also be sent to the remote peer.

Assign remote IP addresses from a.b.c.d to a.b.c.d

The IP addresses in these text boxes define the pool of IP addresses to assign to remote peers during the IP protocol configuration phase of the PPP negotiation process.

Primary DNS server

The IP address of the primary DNS server the remote peer should use when making DNS requests over the link.

Secondary DNS server

The IP address of the secondary DNS server that the remote peer should use when making DNS requests, should the primary server be unavailable.

Allow the PPP interface to answer incoming calls

When enabled, causes the PPP instance to answer an incoming call.

Only allow calling numbers ending with n

When the router is set to answer calls, this setting provides a filter for ISDN sub-addresses. This value is blank by default but when the PPP instance is set to answer calls, only numbers having trailing digits that match the sub-address value in this test will be answered. For example, if this value is set to **123**, only calls from numbers with trailing digits that match this value will be answered; for example, **01942 605123**.

Enable NAT on this interface

When enabled, enables Network Address Translation to operate on this interface. This is the same as for other PPP interfaces.

IP address/IP address and Port

Select whether IP address translation only should be applied or whether port number translation should also be applied to IP packets.

Enable IPsec on this interface

When enabled, causes the router to encrypt traffic on this interface using the IPsec protocol. The following two additional configuration parameters are revealed when this box is checked.

Keep Security Associations (SAs) when this PSTN interface is disconnected

When enabled, causes the router to maintain (such as not flush) the SA when the interface becomes disconnected. The normal behavior is to remove the SAs when the interface becomes disconnected.

Use interface x,y for the source IP address of IPsec packets

If it is required to use another interface (such as not the interface currently being configured) as the source address for IPsec packets, this may be achieved by selecting the desired interface from the drop-down list and typing the desired interface instance number into the adjacent text box.

Enable the firewall on this interface

When enabled, applies the firewall rules to traffic using this interface.

3. Click **Apply**.



Command line

Command	Instance	Parameter	Values	Equivalent web parameter
ppp	n	name	Up to 25 characters	Description
ppp	n	phonenum	up to 25 digits	Dial out using numbers
ppp	n	ph2	“	Dial out using numbers
ppp	n	ph3	“	Dial out using numbers
ppp	n	ph4	“	Dial out using numbers
ppp	n	prefix	0-9999999999	Prefix
ppp	n	username	Up to 60 characters	Username
ppp	n	password	Up to 40 characters	Password
ppp	n	IPaddr	0.0.0.0	Allow the remote device to assign a local IP address to this router
ppp	n	IPaddr	Valid IP address a.b.c.d	Try to negotiate a.b.c.d as the local IP address for this router (in conjunction with L_addr)

Command	Instance	Parameter	Values	Equivalent web parameter
ppp	n	L_addr	off, on When on , allows negotiation When off , force use of specified IP address	Use a.b.c.d as the local IP address for this router (not negotiable)
ppp	n	DNSserver	Valid IP address a.b.c.d	Primary DNS server
ppp	n	secDNS	Valid IP address a.b.c.d	Secondary DNS server
ppp	n	IPmin	Valid IP address a.b.c.d	Assign remote IP addresses from a.b.c.d to a.b.c.d
ppp	n	IPrange	0-255	Assign remote IP addresses from a.b.c.d to a.b.c.d
ppp	n	transDNS	Valid IP address a.b.c.d	Primary DNS server a.b.c.d
ppp	n	sectransDNS	Valid IP address a.b.c.d	Secondary DNS server a.b.c.d
ppp	n	ans	off, on	Allow this PPP interface to answer incoming calls
ppp	n	do_nat	0, 1, 2 0=Disabled 1=IP address 2=IP address and port	Enable NAT on this interface IP address/IP address and Port
ppp	n	natip	Valid IP address a.b.c.d	NAT Source IP address a.b.c.d
ppp	n	ipsec	0=Disabled 1=Enabled 2=Enabled and Keep SAs	Enable IPsec on this interface/ Keep Security Associations when this DialServ interface is disconnected
ppp	n	firewall	off, on	Enable the firewall on this interface

Configure advanced DialServ parameters

Web

1. Go to **Configuration > Network > Interfaces > DialServ > Advanced**.
2. Configure advanced DialServ parameters as needed:

Metric

The route metric that should be applied to this interface.

Enable “Always On” mode of this interface

When enabled, the following two options are displayed:

On/On and return to service immediately

Select whether the always-on functionality should simply be enabled or whether the additional facility to return the interface to the In Service state should be applied.

Put this interface “Out of Service” when an always-on connection attempt fails.

Normally, always-on interfaces do not go out of service unless they have connected at least once. When enabled, this setting causes the router to put the interface out of service even if the first connection attempt fails.

Attempt to re-connect after s seconds

The length of time, in seconds, the router should wait after an “always-on” PPP connection has been terminated before trying to re-establish the link.

If an inhibited PPP interface is connected, attempt to re-connect after s seconds

This setting takes precedence over the previous parameter when another PPP instance that is usually inhibited by this one is connected. Use this parameter to reduce the connection retry rate when a lower priority PPP instance is connected.

Wait s seconds after power-up before activating this interface

The initial delay that the router will apply before activating the PPP instance after power-up. After the initial power-up delay the normal always-on activation timers apply. If set to **0**, no delay is applied.

Control when this interface can connect using Time band n

Enables the time band function and allows selecting the desired time band instance. See [Configuring time bands](#) for more information on time bands.

Keep this interface up for at least s seconds

The minimum period that the PPP interface should remain available. This means that even if the link becomes inactive before this period expires, the connection remains open.

Close this interface**after s seconds**

The maximum time that the link will remain active in any one session. After this time, the link will be deactivated.

If it has been up for m minutes in a day

The router deactivates the PPP instance after it has been active for the value specified in this text box.

If the link has been idle for s seconds

The router deactivates this interface after the time specified in this text box if it detects that the link has not passed any traffic for that period.

Alternative idle timer for static routes s seconds

An alternative inactivity timeout for use in conjunction with the **Make PPP n interface use the alternative idle timeout when this route becomes available** parameter on the **Configuration > Network > IP Routing/Forwarding > Static Routes > Routes n > Advanced** web page. The router uses this timeout until the PPP instance next deactivates only. After that, it uses the normal timeout value.

If the link has not received any packets for s seconds

The amount of time that the router waits without receiving any PPP packets before disconnecting. The timer is reset with each received PPP packet.

If the negotiation is not complete in s seconds

The maximum time, in seconds, allowed for the PPP negotiation to complete. If negotiations have not completed within this period, the interface is deactivated.

Generate an event after this interface has been up for m minutes

The number of minutes, if any, after which the router should create an event in the event log that states that the interface has been active for this period.

Limit the data transmitted over this interface

When enabled, displays the following parameters that control what data volume restrictions, if any, should be applied to this interface:

Issue a warning event after n units

The amount of traffic that will cause a warning event to be generated in the event log stating that the specified amount of data has been transferred. The units are specified by a drop-down list, having the following options; **KBytes**, **MBytes**, **GBytes**. For example, if the monthly tariff includes up to **5** MB of data before excess usage charges are levied, it would be useful to set this threshold to **4** MB. This causes the router to create a warning entry in the event log once **4** MB of data is transferred. You could use this event could to trigger an email alert, SNMP trap, or SMS alert message.

Stop data from being transmitted after n units

The total amount of data that may be transmitted by this PPP instance before the link is blocked for further traffic. The value in the drop-down list specifies the units: **KBytes**, **MBytes**, or **GBytes**.

Reset the data limit on the n day of the month

The day of the month on which the data limit is reset to 0.

3. Click **Apply**.

**Command line**

Command	Instance	Parameter	Values	Equivalent web parameter
ppp	n	metric	0-255	Metric
ppp	n	aodion	0-2 0=disabled 1=enabled 2=On and return to service immediately	Enable “Always On” mode of this interface, On, On and return to service immediately
ppp	n	immoos	on, off	Put this interface “Out of Service” when an always-on connection attempt fails
ppp	n	aodi_dly	0-2147483647	Attempt to reconnect after s seconds
ppp	n	aodi_dly2	0-2147483647	If an inhibited PPP interface is connected, attempt to re-connect after s seconds
ppp	n	pwr_dly	0-2147483647	Wait s seconds after power-up before activating this interface
ppp	n	tband	0-4	Control when this interface can connect using Time Band n
ppp	n	minup	0-2147483647	Keep this interface up for at least s seconds
ppp	n	maxup	0-2147483648	Close this interface after s seconds
ppp	n	maxuptime	0-2147483647	if it has been up for m minutes in a day
ppp	n	timeout	0-2147483648	if the link has been idle for s seconds
ppp	n	timeout2	0-2147483648	Alternative idle timer for static routes s seconds
ppp	n	rxtimeout	0-2147483648	if the link has not received any packets for s seconds
ppp	n	maxneg	0-2147483648	if the negotiation is not complete in s seconds

Command	Instance	Parameter	Values	Equivalent web parameter
ppp	n	uplogmins	0-2147483647	Generate an event after this interface has been up for m mins
ppp	n	dlwarnkb	0-2147483647	Issue a warning after n units
ppp	n	dlstopkb	0-2147483647	Stop data from being transmitted after n units
ppp	n	dlrstday	0-255	Reset the data limit on the n day of the month

Configure serial interfaces

Digi routers support a variety of serial interfaces, either inbuilt or as optional add-on modules. Each asynchronous serial (ASY) port may be configured to operate at different speed, data format etc. These parameters may be changed using the web interface or from the command line using AT commands and S registers.

Web

1. Go to **Configuration > Network > Interfaces > Serial**.
2. A list of supported serial interfaces displays below the Serial link. Click one of the interfaces to configure basic serial configuration.

Note On models fitted with W-WAN modules, one of the interfaces and its associated web page are dedicated to the W-WAN module. The title will reflect this. Similarly, on models fitted with an analogue modem, one of the interfaces will be entitled PSTN port.

[Configuration - Network > Interfaces > Serial > Serial Port 0](#)

Serial

Serial Port 0

Enable this serial interface

Description:

Baud Rate:

Data Bits / Parity:

Flow control:

Enable echo on this interface

CLI result codes:

Enable this serial interface

When disabled, this is the only item that appears in the section. Enabling this setting displays additional configuration parameters.

Description

A description for the interface. For example, if the serial interface is connected to a card payment device, the description could read **Till 1** or similar appropriate text.

Baud Rate

The required baud rate for the associated serial port.

Data Bits / Parity

The required data format for the interface. 8 data bits, no parity is a very common configuration.

Note When the serial port is not in 8-bit parity mode (such as it is in either 8-bit no parity, or 7-bit with parity), the router will continually check for parity when receiving AT commands and adjust and match accordingly.

Flow Control

The router supports software flow control using **XON/XOFF** characters and hardware flow control using the RS232 **RTS** and **CTS** signals. Use this drop-down list to select **Software**, **Hardware** or a combination of **Both**. To disable flow control, select the **None** option.

Enable echo on this interface

When enabled, enables command echo when using the command line interpreter. Disable this setting if the attached terminal provides local echo.

CLI result codes

The required level of verbosity for command result codes. The available options are:

- Verbose
- Numeric
- None

3. Click **Apply**.

Command line

Command	Instance	Parameter	Values	Equivalent web parameter
asy	n/a	descr	Free text-description of interface	Description
S31=n	n/a	n/a	Where n= 3=115200 4=57600 5=38400 6=19200 7=9600 8=4800	Baud rate
S23=n	n/a	n/a	Where n= 0=None 1=Odd 2=Even 5=8 Data Odd 6=8 Data Even Default 0	Data Bits / Parity
&Kn	n/a	n/a	Where n = 0=None 1=Hardware 2=Software 3=Both	Flow Control

Command	Instance	Parameter	Values	Equivalent web parameter
&En	n/a	n/a	Where n = 0=No echo 1=echo	Enable echo on this interface
&Vn	n/a	n/a	Where n = 0=numeric 1=verbose	CLI result codes

Configure advanced serial port parameters

Web

- Go to **Configuration > Network > Serial > Serial Port n > Advanced**.

▼ Advanced

Answer V.120 calls after: rings (0 = Don't answer)

DCD:

DTR Control:

DTR de-bounce time: X 20 milliseconds

Escape Character:

Escape Delay: X 20 milliseconds

Forwarding Timeout: X 10 milliseconds

Break Transmit Escape Character:

- Configure advanced serial parameters as needed:

Answer V.120 calls after n rings (0 = Don't answer)

Controls the answering of incoming V.120 calls. When set to **0**, V.120 answering is disabled, otherwise V.120 answering is enabled on this interface. Enter the number of rings to wait before answering the call into this text box. This is equivalent to setting the value of the **S0** register for the associated serial port.

DCD

Selects how the Data Carrier Detect (**DCD**) signal is controlled. The available options are:

- **Auto**: Configures the router so that it will only assert the DCD line when an ISDN connection has been established; this is equivalent to **AT&C1**.
- **On**: Configures the router such that the DCD line is always asserted when the router is powered-up; this is equivalent to **AT&C0**.
- **Off**: Configures the router such that the DCD line is normally asserted but is de-asserted for the time period specified by the **S10** register after a call is disconnected; this is equivalent to **AT&C2**.
- **Pulse Low**

DTR Control

This drop-down selection box controls how the router responds to the **DTR** signal. The available options are:

- **None**: Configures the router to ignore the DTR signal; this is equivalent to **AT&D0**.
- **Drop call**: Configures the router to disconnect the current call and return to AT command mode when the **DTR** signal from the attached terminal (DTE) is de-asserted; this is equivalent to **AT&D1**.

- **Drop line and call:** Configures the router to disconnect the current call, drop the line and return to AT command mode when the **DTR** signal is de-asserted; this is equivalent to **AT&D2**.
- **Drop call on transition**
- **Drop line and call on transition**

DTR de-bounce time s x 20 milliseconds

The length of time, in multiples of **20** milliseconds, for which the DTR signal must be de-asserted before the router acts on any options that are set to trigger on loss of this signal. Enter the desired multiple into the text box. Increasing this value makes the router less sensitive to “bouncing” of the DTR signal. Conversely, decreasing this value makes the router more sensitive. The default of **100 milliseconds (5 times 20 milliseconds)** is a reasonable value.

Escape Character

The character for the escape sequence. The default is the **+** symbol (ASCII value **43, 0x2b**). Changing this value has the same effect as changing the **S2** register.

Escape Delay s x 20 milliseconds

The required minimum length of the pause in the escape sequence, in multiples of **20** milliseconds. The default is **50 x 20 milliseconds**, which means the escape sequence becomes **+++**, a pause of **1** second and then **AT**, to drop back to AT command mode. If a delay of some other value is required, enter it in the text box.

Forwarding Timeout s x 10 milliseconds

The length of time that the router will wait for more data after receiving at least one octet of data through the serial port and transmitting it onwards. This timer is reset each time more data is received. The router will forward data onwards when either the forwarding timer expires or the input buffer becomes full. This parameter applies to ADAPT, TCPDIAL, TCPERM and PANS.

Break Transmit Escape Character c

The character in the escape sequence. The **-** symbol (ASCII value **45, 0x2d**) is a recommended value. Changing this value has the same effect as changing the **S3** register. To use the break sequence, type **-** three times, with a 1-second pause either side of the three **-** characters. When the Async port detects the following sequence, instead of outputting the three minus characters (they are removed from the output stream), a **BREAK** condition is placed on the Async transmitter for **1** second:

```
<guard time 1 sec>---<guard time 1 sec>
```

3. Click **Apply**.



Command line

Command	Instance	Parameter	Values	Equivalent web parameter
S0=n	n/a	n/a	Where n=0-255	Answer V.120 call after n rings

Command	Instance	Parameter	Values	Equivalent web parameter
&Cn	n/a	n/a	Where n = 0=On 1=Auto 2=Off 3=Pulse low	DCD
&Dn	n/a	n/a	Where n = 0=None 1=Drop line 2=Drop line & call 5=Drop call on transition 6=Drop line & call on transition	DTR
S45=n	n/a	n/a	Where n=0-255	DTR de-bounce
S2=n	n/a	n/a	Where n=ASCII value	Escape Character
S12=n	n/a	n/a	Where n=0-255	Escape delay
S15=n	n/a	n/a	Where n=0-255	Forwarding Timeout
S3=n	n/a	n/a	Where n=ASCII value	Break Transmit Escape Character

Profiles

Each serial port can have two profiles which can be configured differently. The **Profiles** settings select which profile is in force when the router powers-up.

 **Web**

Each serial port can have two profiles which can be configured differently. You can configure which profile is used at power-up.

Use profile at power-up

Use profile n at power-up

Select **0** from the drop-down selection box to choose profile **0** to be active when the router powers-up. Select **1** from the selection box to make profile **1** the active profile.

Load Config from Profile n

Select **0** from the drop-down selection box and click the button to load profile **0**.

Apply & Save Changes to Profile n

Select **0** from the drop-down selection box and click the button to apply configuration changes and save profile **0** after making any changes.

**Command line**

Command	Instance	Parameter	Values	Equivalent web parameter
&Yn			Where n =0, 1	Use profile n at power-up
&Zn			Where n =0, 1	Load Config from Profile n
&Wn			Where n =0, 1	Apply & Save Changes to Profile n

Configure synchronous communications

The most common form of serial communications currently is asynchronous. Synchronous serial communications links are still in use, and TransPort routers can support these. HDLC is a synchronous protocol still in use that you can use with TransPort routers. This section describes how to configure the synchronous communications interfaces. To enable synchronous mode, a protocol such as LAPB must be configured to use a synchronous port as its lower layer interface. On certain models, an informational message will appear on the web page which states that jumper settings may need to be changed in order to support synchronous serial operation.

Note The number of synchronous serial ports available varies depending on the model and any optional modules fitted.

Web

1. Go to **Configuration > Network > Interfaces > Serial > Serial Port n > Sync Port n**.
2. Configure synchronous port settings:

Description

A description of the interface, if one is required.

Clock source Internal / External

Specifies whether the synchronous port generates the clock signal (**Internal**) or relies on an external source for the clock signal (**External**).

Mode

The specific serial protocol to use. Which buttons appear depend upon the capabilities of the interface. The options available are; **V.35**, **EIA530**, **RS232**, **EIA530A**, **RS449**, and **X.21**.

Invert RX clock

When enabled, causes the router to invert the voltage level of the receive clock signal.

Invert TX clock

When enabled, causes the router to invert the voltage level of the transmit clock signal.

Encoding NRZ / NRZI

Select between non-return to zero (NRZ) and non-return to zero (inverted) (NRZI) signal encodings.

3. Click **Apply**.

Command line

Command	Instance	Parameter	Values	Equivalent web parameter
sy	0	descr	Text description of interface	Description
sy	0	clksrc	int,ext	Clock source

Command	Instance	Parameter	Values	Equivalent web parameter
sy	0	rxclkinv	off, on	Invert RX clock
sy	0	txclkinv	off, on	Invert TX clock
sy	0	encode	nrz,nrzi	Encoding

Configure rate adaptation

The router supports two rate adaptation protocol (Adapt) instances. Each instance enables the selection and configuration of the protocol to use for rate adaptation over an ISDN B channel. The supported protocols are **V.110**, **V.120**, and **X.75**. Depending on which protocol is selected, there may be an associated LAPB instance (distinct from the two general purpose LAPB instances), as for example, when error-corrected (multi-frame) mode uses **V.120**.

Web

1. Go to **Configuration > Network > Interfaces > Serial > Rate Adaption**.

There are two rate adaption instances. These pages show displays the configuration parameters directly relevant to the rate adaptation protocol only, LAPB configuration pages are to be found here in the **Configuration > Network > Legacy Protocols > X.25 > LAPB** page. When configuring LAPB parameters, be aware that **adapt 0** uses **LAPB 2** and **adapt 1** uses **LAPB 3**.

▼ Rate Adaption
▼ Rate Adaption 0

Attempt to redial the connection times if rate adaption has not been negotiated

Drop the connection if it is idle for hrs mins secs

Leased line mode

Enable TCP rate adaption

Connect to IP Address: Port:

Listen on Port:

2. Configure rate adaption parameters as needed:

Attempt to redial the connection n times if rate adaption has not been negotiated

If an ISDN connection is established, but rate adaption is not negotiated, the value in this text box specifies how many times the router should drop the connection and redial it.

Drop the connection if it is idle for h hrs m mins s secs

The time to wait before dropping the connection if the connection becomes idle.

Leased line mode

When enabled, allows the router to attempt to maintain the connection automatically once it has been established.

Enable TCP rate adaption

When enabled, enables use of rate adaptation when using a TCP connection rather than an ISDN line. When enabled, the following controls become enabled:

Connect to IP Address a.b.c.d Port n

When using a TCP connection, these text entry boxes allow the user to specify the IP address and port number that the protocol should use.

Listen on Port

The port number that the router is listening on when in socket mode.

3. Click **Apply**.

**Command line**

Command	Instance	Parameter	Values	Equivalent web parameter
adapt	0, 1	dial_retries	0-255	Attempt to redial the connection n times
adapt	0, 1	tinact	0-86400	Drop the connection if it is idle for h hrs m mins s secs
adapt	0, 1	leased_line	off, on	Leased line mode
adapt	0, 1	sockmode	0, 1 0=disable 1=enable	Enable TCP rate adaption
adapt	0, 1	ip_addr	valid IP address a.b.c.d	Connect to IP Address a.b.c.d Port n
adapt	0, 1	ip_port	valid TCP port number	Connect to IP Address a.b.c.d Port n
adapt	0, 1	lip_port	valid TCP port number	Listen on Port n

Configure command alias mappings

The router supports a number of command aliases which specify strings to be substituted for commands entered at the command line.

Web

- Go to **Configuration > Network > Interfaces > Serial > Command Mappings**.
The table on the **Command Mappings** page contains two text entry boxes and an **Add** button. You can specify up to 23 command mappings. For example, suppose a user coming from a Unix™ background feels more comfortable typing **ls** rather than the native **dir** command in order to list the files in a directory. To achieve this aliasing, enter **ls** into the **From** column in the table, **dir** into the **To** column and then click the **Add** button.

From	To	Allow AT Responses
No command mappings configured		

ON ▾ Add

Apply

- Enter the command alias mappings

From

The substitute text.

To

The command that should be substituted.

Add

Click this button to add the command mapping.

Delete

When the mapping has been added, a Delete button is enabled in the right-hand column. Clicking this button removes the binding from the table.

Allow AT Responses

Enables or disables entry of AT commands and their responses over the serial port.

Note If either the **From** or **To** string contains spaces, the entire string must be enclosed within double quotation marks. When substituting a command, upper case characters are considered the same as the corresponding lower case characters.

- Click **Apply**.

 **Command line**

Command	Instance	Parameter	Values	Equivalent web parameter
cmd	n	cmdmapi	Replacement command	From
cmd	n	cmdmapo	Command to be substituted	To

Configure protocol bindings

Digi routers can be configured to allow using different protocols on different interfaces. The process of selecting which protocol to use on a particular interface is referred to as binding. For example, you could use **Serial (ASY)** port **0** for an ISDN B channel X.25 connection, where **PAD 0** is bound to **Serial 0** (assuming that **PAD 0** is the required PAD). To complete this example it is also necessary to associate the PAD with a LAPB instance using the appropriate page. Protocols are bound to serial interfaces using a table with a drop-down list box for selecting the protocol and a drop-down list for selecting the serial port.

By default, if no specific protocol is bound to a serial interface, a PPP instance is automatically associated with that port. This means that PPP is treated as the default protocol associated with the serial ports.

Web

1. Go to **Configuration > Network > Interfaces > Serial > Protocol Bindings**.
2. Bind protocols to serial interfaces:

▼ Protocol Bindings

The PPP protocol is bound to serial ports by default.

Protocol	Bound to	
No bindings have been added		
PAD 0 ▼	Serial 0 ▼	Add

Apply

Protocol

Select the desired protocol from this drop-down list.

Bound to

Select the desired serial port from this drop-down list.

Add

Click this button to add the binding.

Delete

When a binding has been added, it appears in the table and a Delete button is enabled in the right-hand column. Click this button to remove the binding. Note that the binding does not come into force until the Apply button at the bottom of the page has been clicked.

3. Click **Apply**.

 **Command line**

Entity	Instance	Parameter	Values	Equivalent web parameter
bind	n	prot1	Valid protocol, such as PAD 0	Protocol
bind	n	id1	Valid serial port such as ASY 5	Bound to

Display list of current bindings

To display a list of the current bindings enter the command:

```
bind ?
```

Bind a V.120 instance 0 to asynchronous serial port 3

```
bind pad 0 asy 0
binds PAD 0 to serial port 0.
bind v120 0 asy 3
```

Access the Internet using PPP

To access the Internet using PPP via a terminal connected to serial interface **2**, enter the command:

```
bind ppp 1 asy 2
```

Bind a TANS instance to an ADAPT instance

Currently it is only possible to bind a TANS instance to an ADAPT instance using the **bind** command. The format of the command is:

```
bind adapt <instance> tans <instance>
```

Configure virtual serial ports

TransIP is a way of using virtual serial ports for serial connections over an IP socket, multiplying the number of concurrent serial connections to a router. You can configure TransIP to actively connect on a TCP socket, such as making outgoing connections.

Web

1. Go to **Configuration > Network > Interfaces > Serial > TransIP Serial Ports**.

The message at the top of the **TRANSIP Serial Ports** page states which serial interface the TransIP connection uses.

▼ TRANSIP Serial Ports

▼ Transip 0

This TransIP is using Serial port 11

Listen on port:

Connect to IP Address or Hostname: Port

Send TCP Keep-Alives every: seconds

Enable Stay Connected mode

Disable command echo

Escape char:

Escape delay: milliseconds

2. Configure virtual serial ports:

Listen on port n

The TCP port number that the router should listen on.

Connect to IP Address or Hostname a.b.c.d Port n

A valid IP address or hostname the router uses to make the outgoing TransIP connection. If this parameter is set to a non-zero number, the number is the TCP port number to use when making TCP socket connections. When set to **0**, TransIP listening on the port defined above only.

Send TCP Keep-Alives every s seconds

The amount of time, in seconds, a connection stays open without any traffic being passed.

Enable Stay Connected mode

When enabled, causes the router to refrain from clearing the TCP socket at the end of a transaction, data call or data session (depending on what the TransIP serial port was bound to and what protocol it was using). When disabled, the router can clear the socket. For example, if the TransIP port is bound to a TPAD and the setting is disabled, the TransIP TCP socket is cleared at the end of the TPAD transaction.

Disable command echo

When enabled, disables command echo for the TransIP port. When disabled, all commands issued are echoed back to the TransIP TCP socket.

Escape char c

The ASCII character to use as the escape character. The default character is **+**. Entering this escape character three times followed by a pause of at least the **Escape delay** parameter and an **AT** command causes the router to switch back to command mode from online mode. This is equivalent to the **S2** register setting.

Escape delay s milliseconds

The delay required between entering the escape sequence (default **+++**) and the **AT** command for the router to drop back into command mode. This is equivalent to the **S12** register setting.

3. Click **Apply**.

**Command line**

Command	Instance	Parameter	Values	Equivalent web parameter
transip	n	port	Valid port number 0-65535	Listen on port
transip	n	host	Valid IP address a.b.c.d or hostname	Connect to IPAddress a.b.c.d or Hostname
transip	n	remport	Valid port number 0-65535	Port
transip	n	keepact	0-255	Send TCP Keep-Alives every s seconds
transip	n	staycon	on, off	Enable Stay Connected mode
transip	n	cmd_echo_off	on, off	Disable command echo
transip	n	escchar	Valid ASCII character	Escape char c
transip	n	esctime	0-255	Escape delay s milliseconds

Configure port redirection using RealPort

Digi devices use the patented RealPort COM/TTY port redirection for Microsoft Windows.

RealPort software provides a virtual connection to serial devices, no matter where they reside on the network. The software is installed directly on the host PC and allows applications to talk to devices across a network as though the devices were directly attached to the host. Actually, the devices are connected to a Digi device somewhere on the network. RealPort is unique among COM port redirectors because it is the only implementation that allows multiple connections to multiple ports over a single TCP/IP connection. Other implementations require a separate TCP/IP connection for each serial port. Unique features also include full hardware and software flow control, as well as tunable latency and throughput. Access to RealPort services can be enabled or disabled.

Encrypted RealPort

Digi devices also support RealPort software with encryption. Encrypted RealPort offers a secure Ethernet connection between the COM or TTY port and a device server or terminal server.

Encryption prevents internal and external snooping of data across the network by encapsulating the TCP/IP packets in a Secure Sockets Layer (SSL) connection and encrypting the data using Advanced Encryption Standard (AES), one of the latest, most efficient security algorithms. Access to Encrypted RealPort services can be enabled or disabled. Digi's RealPort with encryption driver has earned Microsoft's Windows Hardware Quality Lab (WHQL) certification. Drivers are available for a wide range of operating systems, including Microsoft Windows Server 2003, Windows XP, Windows 2000, Windows NT, Windows 98, Windows ME; SCO Open Server; Linux; AIX; Sun Solaris SPARC; Intel; and HP-UX. It is ideal for financial, retail/point-of-sale, government or any application requiring enhanced security to protect sensitive information.

Web

1. Go to **Configuration > Network > Interfaces > Serial > RealPort.**

▼ **RealPort**

Enable RealPort
Listen on port:
Maximum number of sockets:

Enable encrypted Realport
Encryption mode to listen on port:
Maximum number of encryption sockets:

Enable Device Initiated RealPort
Connect to host: Port:
Allow seconds between connection attempts

Send TCP Keep-Alives every: seconds
Send RealPort Keep-Alives every: seconds

Enable authentication
Authentication secret:

2. Configure RealPort parameters:

Enable RealPort

Enables RealPort on the router.

Listen on port n

The TCP port on which the router will listen for RealPort connections.

Maximum number of sockets

The maximum number of RealPort connections that the router will support.

Enable encrypted RealPort

Selecting this option enables encrypted RealPort on the router.

Encryption mode to listen on port n

The TCP port on which the router will listen for encrypted RealPort connections.

Maximum number of encryption sockets

The maximum number of encrypted RealPort connections that the router will support.

Enable Device Initiated RealPort

Selecting this option enables router to make a RealPort connection to a host PC.

Connect to host a.b.c.d Port n

The IP address or hostname and TCP port that the router should use when making a device initiated connection.

Allow s seconds between connection attempts

The interval, in seconds, between device initiated connection attempts.

Send TCP Keep-Alives every s seconds

The interval at which TCP Keep-Alives are sent over the RealPort connection. A value of **0** means that Keep-Alives are not sent.

Send RealPort Keep-Alives every s seconds

The interval at which RealPort Keep-Alives are sent over the RealPort connection. A value of **0** means that Keep-Alives are not sent.

Enable exclusive mode

Enables exclusive mode. Exclusive mode allows a single connection from any one RealPort client ID to be connected only. If this setting is enabled and a subsequent connection occurs that has the same source IP as an existing connection, the old existing connection is forcibly reset under the assumption that it is stale.

Enable authentication

Enables RealPort authentication.

Authentication secret

Configures the RealPort authentication secret.

3. Click **Apply**.

**Command line**

Command	Instance	Parameter	Values	Equivalent web parameter
rport	0	enabled	off, on	Enable RealPort
rport	0	ipport	0-65535	Listen on port n
rport	0	maxnbsocks	0-255	Maximum number of sockets
rport	0	encryption	off, on	Enable encrypted RealPort
rport	0	encport	0-65535	Encryption mode to listen on port
rport	0	maxnbencsocks	0-255	Maximum number of encryption sockets
rport	0	initiate	off, on	Enable Device Initiated RealPort
rport	0	IPaddr	Valid IP address a.b.c.d	Connect to host a.b.c.d Port n

Command	Instance	Parameter	Values	Equivalent web parameter
rport	0	initiateport	0-65535	Connect to host a.b.c.d Port n
rport	0	initiatebackoff	0-255	Allow s seconds between connection attempts
rport	0	tcpkeepalives	0-255	Send TCP Keep-Alives every s seconds
rport	0	rportkeepalives	0-255	Send RealPort Keep-Alives every s seconds
rport	0	exclusive	off, on	Enable exclusive mode
rport	0	auth	off, on	Enable authentication
rport	0	secret	Up to 30 characters	Authentication secret

Configure sending serial data to multiple serial ports

Web

- Go to **Configuration > Network > Interfaces > Serial > MultiTX > MultiTX Serial Port n**.
The **MultiTX** page is for enabling and setting the MultiTX parameters. This page supports sending serial data to multiple (up to 5) TCP or UDP destinations. When enabled, the configured **ASY** port is opened and serial data from the port is sent to all configured destinations.

Enable MultiTX
 Serial Port:
 Protocol: TCP UDP
 Socket Inactivity Timeout:
 Source port:
 Send Socket ID
 Reopen closed sockets:
 Send serial data only when the match string is present

You can specify up to 5 remote hosts

Remote Hosts	
Host	Port
No remote hosts configured	
<input type="text"/>	<input type="text"/>
<input type="button" value="Add"/>	

- Configure MultiTX settings:

Enable Multitx

When enabled, displays the MultiTX settings in the web interface and enables the MultiTX function on the router.

Serial Port

The serial interface to use. Data received on this serial will be forwarded to all configured remote hosts.

Protocol

Selects the transport method: either TCP or UDP.

Socket Inactivity Timeout

If there is no data transmitted for the specified number of seconds, the socket will be closed. 0=no timeout.

Source port

The source port number.

Send Socket ID

When enabled, the text entered into the **Socket ID** field is transmitted to the remote host when the socket connects.

Reopen Closed Socket

Enables an always-on mode. If the socket is closed for any reason, the router attempts to reconnect to the remote host.

Socket ID

Used in conjunction with **Send Socket ID**. The text entered is transmitted when the socket connects. You can use `\r` for **CR** and `\n` for **NL**. To specify hexadecimal, use `\xhh` where **hh** is the hexadecimal code. For example `\x04` defines binary character **04**.

Send serial data only when the match string is present

Enables or disables the match string function.

Match String

When enabled, forwards serial data to remote hosts only when the **Match String** text is present.

Strip match string before sending

When enabled, the text in the **Match String** field is removed before forwarding the data to the remote host.

Remote host

Up to five remote hosts can be specified in these fields.

Host

Enter the hostname or IP address of the remote host in this field.

Port

Enter the TCP or UDP port number that the remote host is listening on.

Add

Click this button to add the remote host.

- Click **Apply**.

**Command line**

Command	Instance	Parameter	Values	Equivalent web parameter
multitx	0	enabled	off, on	Enable MultiTX
multitx	0	srcport	off, on (default: off)	Serial Port
multitx	0	prot1	off, on (default: off)	protocol

Command	Instance	Parameter	Values	Equivalent web parameter
multitx	0	send_sockid	0-255 (default: 0)	Send Socket ID
multitx	0	keepopen	off, on	Reopen Closed Socket
multitx	0	sockid		Socket ID
multitx	0	fwd_match	0-65535	Send serial data only when the match string is present
multitx	0	matchstring	0-255	Match String
multitx	0	Strip_match	off, on	Strip match string before sending

Configure IPv6 addressing support

IPv6 is an updated version of the Internet Protocol (IP). Until recently, the Internet has used a previous version, IPv4.

IPv4 addresses are **32** bits long. Over 4 billion addresses are available through IPv4, though not all the addresses are usable. IPv6 addresses are **128** bits long. Taking into account the structure of the IPv6 address, there are 4.6×10^{18} globally routable addresses available. This equates to approximately 650 million IP addresses for each person in the world.

Since every device can have a globally routable IPv6 address, there is no need for NAT with IPv6. This means it is very important to properly configure IP filters and firewall rules to prevent direct attacks on hosts on the LAN networks.

By default, IPv6 is disabled on TransPort routers.

TransPort devices do not support static configuration of IPv6 addresses. Instead, it relies on learning prefixes, routes, and DNS addresses from an upstream router.

IPv6 support is for Ethernet interfaces only

You can configure IPv6 addressing on Ethernet interfaces **eth 0**, **eth 1**, **eth 2**, and **eth 3** only. There is no IPv6 support on other Ethernet interfaces, or other interfaces, such as PPP, GRE tunnel, or OpenVPN.

IPv6 modes

You can configure Ethernet interfaces to operate in one of two IPv6 modes: WAN mode or LAN mode.

WAN mode

In WAN mode, the interface listens for Router Advertisement (RA) messages, if enabled. The interface assigns itself an IPv6 address from any suitable prefixes it sees in the RA messages (for example, 64-bit, on-link, auto-config bit set). Learned prefixes and routes are added to the IPv6 routing table. Advertised DNS addresses are added to the list of learned DNS addresses.

By default, if DHCPv6 is enabled, the interface attempts to obtain an IPv6 address using DHCPv6. The router also attempts to learn prefixes from the upstream router for prefix delegation. DNS addresses learned through DHCPv6 are added to the list of learned DNS addresses.

Default routes are added into the IPv6 routing table when the router sees RA messages from an upstream router. If RA learning is disabled, no default routes are added to the routing table. For this reason, Digi recommends you enable RA learning.

LAN mode

In LAN mode, the interface subnets delegated prefixes, assigns itself addresses from these subnetted prefixes, advertises the subnetted prefixes in RA messages, and assigns downstream hosts an address from this prefix via DHCPv6. RA messages include the subnet prefix in them, so downstream hosts can use SLAAC to assign itself an address from this prefix.

The DHCPv6 server advertises addresses in the DNS address list, provided the addresses are not link-local addresses.

Typical IPv6 configuration

A typical IPv6 configuration includes:

- Configure an interface in WAN mode to allow the device to learn addresses.
- Configure several interfaces in LAN mode to allow downstream hosts to learn addresses.

IPv6 support in the web interface

Web

Support for IPv6 addressing in the web interface is limited to configuring Ethernet interfaces, WANs, and LANs to use IPv6 addressing. The command-line interface provides more functionality for managing and displaying IPv6 address information. See [IPv6 support in the command-line interface](#).

Configuration > Network > Interfaces > IPv6

IPv6-enabled interfaces

IPv6 is enabled on the following interfaces:

Interface	IPv6 WAN/LAN Instance	Action
ETH 0	IPv6 WAN 0	Delete
(ETH 0-27 dropdown)	(IPv6 WAN 0-1, IPv6 LAN 0-5 dropdown)	Add

IPv6 WAN

- IPv6 WAN 0
 - Enable router learning on this interface
 - Enable DHCPv6 client on this interface
- IPv6 WAN 1

IPv6 LAN

- IPv6 LAN 0
 - Mode: (SLAAC/DHCPv6/SLAAC+DHCPv6 dropdown)
 - Subnet ID:
 - Subnet ID Length:
- DHCPv6 Server (visible only if DHCPv6 or SLAAC+DHCPv6 is selected)
 - Preference Value:

- Router Advertisements
 - Enable router advertisements on this interface
 - The following parameters are visible only if the **Enable router advertisements on this interface** checkbox is checked:
 - Maximum Router Advertisements Interval:
 - Minimum Router Advertisements Interval:
 - Include link MTU
 - Reachable Time:
 - Retransmission Timer:
 - Hop Limit:
 - Default Lifetime:
- IPv6 LAN 1
- IPv6 LAN 2
- IPv6 LAN 3
- IPv6 LAN 4
- IPv6 LAN 5

IPv6 Source IP Address Selection Policy table

The IPv6 Source IP Address Selection Policy table sets the preference when selecting an IPv6 address to use as the source IP when connecting to an IPv6 destination. Normally, the values in this table do not need to be changed from their defaults. For example:

▼ IPv6 Source IP Address Selection Policy

IPv6 Prefix	Label	
::1/128	0	Delete
::/0	1	Delete
::ffff:0:0/96	4	Delete
2002::/16	2	Delete
2001::/32	5	Delete
fc00::/7	13	Delete
::/96	3	Delete
fec0::/10	11	Delete
3ffe::/16	12	Delete
		Add

IPv6 support in the command-line interface

Command line

The TransPort router command-line interface provides support for IPv6 addressing in these areas:

"eth" command

The **eth** command has several new parameters to support IPv6 addressing on Ethernet interfaces:

ipv6_mode (off, wan, lan)

The operating mode of the Ethernet interface.

ipv6_wan (0, <number of ipv6_wan parameter instances> - 1)

Determines which ipv6_wan parameter group instance will be used by the interface if **ipv6_mode** is set to **wan**.

ipv6_lan (0, <number of ipv6_lan parameter instances> - 1)

Determines which ipv6_lan parameter group instance will be used by the interface if **ipv6_mode** is set to **lan**.

eth x status

Shows IPv6 addresses currently assigned to the interface after the existing IPv4 information.

"ipv6_wan" command

ipv6_wan configures a WAN to use IPv6 addressing. There are two instances of this parameter group.

Parameters include:

ra_learn (OFF, ON)

Enables learning of prefixes, routes and DNS addresses from an upstream router (supports up to 2 upstream routers on a first-come, first-served basis).

"dhcpv6_client" command

dhcpv6_client enables the DHCPv6 client on the WAN interface. If enabled, the device will attempt to learn IPv6 addresses, delegated prefixes, and DNS server addresses from an upstream router. The allowed values for this command are **OFF** and **ON**.

"ipv6_lan" command

ipv6_lan configures a LAN to use IPv6 addressing. There are 6 instances of this parameter group.

Parameters include:

mode (slaac, dhcpv6, slaac_dhcpv6)

Determines the operating mode for the LAN interface.

- **slaac**: The device sends RA messages. The **managed** and **other config** flags are both clear. Prefix options will have the **autonomous config** flag set.

- **dhcpv6:** The DHCPv6 server is enabled. It will assign addresses from any prefixes the LAN interface has assigned to it to DHCPv6 clients on downstream hosts. RA messages will have the **managed** and **other config** flags set. Prefix options will have the **autonomous config** flag clear.
- **slaac_dhcpv6:** Both the RA server and the DHCPv6 server are enabled. RA messages will have the **managed** flag clear. The **other config** flag will be set. Prefix options will have the **autonomous config** flag set.

subnet_id: (hex string up to 32 characters in length, default value matches the **ipv6_lan** instance number)

This value is appended to delegated prefixes and then assigned to the LAN interface.

subnet_id_length: (0-128, default: 8)

Indicates the length, in bits, of the **subnet_id**. This length is added to delegated prefixes when creating the subnetted prefix. Note that current behavior is to extend the subnet prefix length to **64** bits if the combined length of the delegated prefix and the **subnet_id** length is less than **64** bits.

"dhcpv6_server" command

dhcpv6_server configures the DHCPv6 server instances associated with the **ipv6_lan** instance of the same value. There are the same number of instances as there are **ipv6_lan** instances.

Parameters include:

preference: (0-255)

Indicates the preference value that will be advertised by the DHCPv6 server.

"ra_server" command

ra_server configures the RA server instances associated with the **ipv6_lan** instance of the same value. There are the same number of instances as there are **ipv6_lan** instances.

Parameters include:

enabled (OFF, ON)

Enables the RA server.

max_ra_interval (4-1800, default value: 600)

The maximum interval (in seconds) between RA messages.

min_ra_interval (3-1350), default value: 200)

The minimum interval (in seconds) between RA messages. Note that the minimum interval is further limited to 3/4 of the maximum interval.

link_mtu: (OFF, ON)

RA messages will include the link MTU option when set to **ON**. The MTU value is set to the configured interface MTU.

reachable_time: (0-3600000)

The advertised "reachable" time (in milliseconds) in RA messages.

retrans_time: (0-2147483647)

The advertised "retransmit" time (in milliseconds) in RA messages.

hop_limit: (0-255, default value: 64)

The advertised hop limit in RA messages.

default_lifetime: (0-9000, default value: 1800)

The advertised default lifetime (in seconds) in RA messages.

"ipv6ippolicy" command

The **ipv6ippolicy** command displays and modifies the IPv6 source IP address policy table as described in RFC6724. This table is interrogated when selecting the source IP address to use on outgoing packets generated by the device. It would be a bit unusual to use anything but the default values.

"ipv6ippolicy print":

Prints the current policy table.

Other **ipv6ippolicy** parameters include

prefix (IPv6 prefix, default depends on instance)

Destination IPv6 addresses are matched against the prefixes to find the entry with matching label.

label:

The label associated with the prefix configured into the same instance.

"dhcpv6_client" command**dhcpv6_client status**

Shows the status of the DHCPv6 clients.

dhcpv6_client solicit|renew|release <entity> <instance>

Instructs the DHCPv6 client to perform the requested action.

"dhcpv6_server" command**dhcpv6_server status**

Shows the status of the DHCPv6 servers.

"ndp" command

Shows the Neighbor Discovery Protocol (NDP) cache.

```
ndp -a <entity> <instance>
```

If the entity and instance are omitted, shows NDP caches for all interfaces.

ndp -d <entity> <instance> -

Deletes the NDP cache. If the entity and instance are omitted, deletes NDP caches for all interfaces.

"route6" command

route6 print

The **route6** command shows the IPv6 routing table.

Note Some of the displayed routes may point to unfamiliar interfaces. For example, the interface **TCP 0** refers to the "loopback" interface. The routing table will contain entries that point to this interface for any address that is owned by the device. **NULL 0** refers to the "blackhole" interface. Packets that are routed to this interface are dropped.

"ipv6 show" command

ipv6 show shows IPv6-related information.

```
ipv6 show <entity> <instance>
```

If entity and instance are omitted, shows information for all interfaces. Information displayed includes:

- Information learned from RA messages, including routes, prefixes and DNS server addresses.
- A list of multicast groups the interface is listening on.
- A list of all learned DNS server addresses.
- A list of all delegated prefixes learned from upstream routers.
- All subnet prefixes assigned to LAN interfaces.

Configure a WAN for IPv6

Configuring a WAN to support IPv6 addressing involves these settings:

- Enabling learning of prefixes, routes, and DNS addresses from an upstream router. The device supports up to **2** upstream routers, on a first-come, first-served basis.
- Enabling the DHCPv6 client on the WAN interface. If enabled, the device attempts to learn IPv6 addresses, delegated prefixes, and DNS server addresses from an upstream router.

Web

1. Go to **Configuration - Network - Interfaces - IPv6 > IPv6 WAN**.
2. Enable IPv6 for the Ethernet interface: in the list of Ethernet interfaces, select the interface, the IPv6 WAN instance, and click **Add**.
3. Click **IPv6 WAN**.
4. Select the IPv6 WAN instance associated with the Ethernet interface and set parameters for the instance:
 - Select **Enable router learning on this interface** to enable learning of prefixes, routes and DNS addresses from an upstream router.
 - Select **Enable DHCPv6 client on this interface** to enable the DHCPv6 client on the WAN interface.
5. Click **Apply**.

Command line

1. Set the operating mode of the Ethernet interface to **wan**.

```
eth 1 ipv6_mode wan
```

2. Assign the desired IPv6 WAN instance to the Ethernet interface.

```
eth 1 ipv6_wan 1
```

3. Enable learning of prefixes, routes and DNS addresses from an upstream router.

```
ipv6_wan 1 ra_learn on
```

4. Enable the DHCPv6 client on the WAN interface.

```
dhcpv6_client on
```

5. Save your configuration changes.

```
config 0 save
```

Configure a LAN for IPv6

The router supports IPv6 addressing on Ethernet interfaces **eth 0**, **eth 1**, **eth 2**, and **eth 3** only. The default for IPv6 support on these interfaces is disabled.

Web

1. Go to **Configuration - Network - Interfaces - IPv6 > IPv6 LAN**.
2. Enable IPv6 for the Ethernet interface: In the list of Ethernet interfaces, select the interface instance, the IPv6 LAN instance, and click **Add**.
3. Click **IPv6 LAN**. Select the IPv6 LAN instance associated with the Ethernet interface and set parameters for the instance:
4. Select the operating mode for the LAN interface in the **Mode** field.
 - **SLAAC**: The device sends Router Advertisement (RA) messages. In these messages, the **managed** and **other config** flags are both clear. Prefix options will have the **autonomous config** flag set.
 - **DHCPv6**: Enables the DHCPv6 server. The DHCPv6 server assigns addresses from any prefixes the LAN interface has assigned to it to DHCPv6 clients on downstream hosts. RA messages will have the **managed** and **other config** flags set. Prefix options will have the **autonomous config** flag clear.
 - **SLAAC + DHCPv6**: Both the RA server and the DHCPv6 server are enabled. RA messages will have the **managed** flag clear. The **other config** flag will be set. Prefix options will have the **autonomous config** flag set.
5. (Optional) Enter the subnet ID in the **Subnet ID** field. This value is appended to delegated prefixes and then assigned to the LAN interface. The default is the IPv6 LAN instance number.
6. (Optional) Enter the length of the subnet ID in the **Subnet ID Length** field: This length is added to delegated prefixes when creating the subnetted prefix. The default is **8**.
7. Click **DHCPv6 Server**. Enter the preference value that the DHCPv6 server will advertise.
8. Click **Router Advertisements** and configure parameters for the Routing Advertisements (RA) server.
 - **Enable router advertisements on this interface**: Enables or disables the RA server.
 - **Maximum Router Advertisements Interval**: The maximum interval, in seconds, between RA messages.
 - **Minimum Router Advertisements Interval**: The minimum interval (in seconds) between RA messages. Note that the minimum interval is further limited to 3/4 of the maximum interval.
 - **Include link MTU**: When enabled, RA messages include the link MTU option. The MTU value is set to the MTU of the configured interface.
 - **Reachable Time**: The advertised "reachable" time, in milliseconds, in RA messages.
 - **Retransmission Timer**: The advertised "retransmit" time, in milliseconds, in RA messages.
 - **Hop Limit**: The advertised hop limit in RA messages.
 - **Default Lifetime**: The advertised default lifetime, in seconds, in RA messages.

9. (Optional) As needed, view and change the IPv6 source IP address selection policy. See [Show and update the IPv6 source IP address policy table](#).
10. Click **Apply**.



Command line

1. Set the operating mode of the Ethernet interface to **lan**.

```
eth 1 ipv6_mode lan
```

2. Assign the desired IPv6 LAN instance to the Ethernet interface.

```
eth 1 ipv6_lan 1
```

3. Select the operating mode for the LAN interface:

- **slaac**: The LAN interface uses the RA server to send RA messages.
- **dhcpv6**: The LAN interface uses the DHCPv6 server.
- **slaac_dhcpv6**: The LAN interface uses both the RA server and the DHCPv6 server.

```
ipv6_lan 1 mode slaac_dhcpv6
```

4. (Optional) Specify the subnet ID. This value is appended to delegated prefixes and then assigned to the LAN interface. The default is the IPv6 LAN instance number.

```
ipv6_lan 1 subnet_id 00
```

5. (Optional) Enter the length of the subnet ID. This length is added to delegated prefixes when creating the subnetted prefix. The default is **8**.

```
ipv6_lan n subnet_id_length 8
```

6. (Optional) If you set the LAN interface operating mode to **dhcpv6** or **slaac_dhcpv6**, configure the preference value to advertise to DHCPv6 server instances associated with the **ipv6_lan** instance. The instance number (in this example, **2**) should be the same as the **ipv6_lan** instance number.

```
dhcpv6_server 2 preference 1
```

7. (Optional) If you set the LAN interface operating mode to **dhcpv6** or **slaac_dhcpv6**, configure parameters for the Routing Advertisements (RA) server, as needed. In all of these, the **ra_server** instance number *x* must be the same as the IPv6 LAN instance number:
 - **ra_server x enabled (OFF, ON)**: Enables or disables the RA server.
 - **ra_server x max_ra_interval (4-1800, default value: 600)**: The maximum interval, in seconds, between RA messages.
 - **ra_server x min_ra_interval (3-1350, default value: 200)**: The minimum interval, in seconds, between RA messages. Note that the minimum interval is further limited to 3/4 of the maximum interval.
 - **ra_server x link_mtu(OFF, ON)**: When enabled, RA messages include the link MTU option and the MTU value is set to the MTU of the configured interface.
 - **ra_server x reachable_time: (0-3600000)**: The advertised reachable time, in milliseconds, in RA messages.
 - **ra_server retrans_time: (0-2147483647)**: The advertised retransmit time, in milliseconds, in RA messages.
 - **ra_server x hop_limit: (0-255, default value: 64)**: The advertised hop limit, in number of hops, allowed in RA messages.
 - **ra_server x default_lifetime: (0-9000, default value: 1800)**: The advertised default lifetime, in seconds, in RA messages.

For example:

```
ra_server 2 enabled on
ra_server 2 link_mtu on
```

8. (Optional) As needed, view and change the IPv6 source IP address selection policy. See [Show and update the IPv6 source IP address policy table](#).
9. Save your configuration changes.

```
config 0 save
```

Show and update the IPv6 source IP address policy table

The IPv6 address policy table defines the IPv6 source IP address to use on outgoing packets generated by the device. It allows you to select the best type of IP address (such as global, link local, and so on) for a particular type of connection. In most cases, the default values set in this table are sufficient and do not need to be changed. For more information about the IPv6 source IP address policy table, see the IETF document [RFC6724, Default Address Selection for Internet Protocol Version 6 \(IPv6\)](#).

Normally the default values that exist in this table do not need to be changed.

Web

Go to **Configuration > Network > Interfaces > IPv6 > IPv6 Source IP Address Selection Policy**.

Add an entry in the table

1. Enter the IPv6 address prefix in the **IPv6 Prefix** field.
2. Enter a label for the IPv6 prefix in the **Label** field.
3. Click **Add**.

Delete an entry in the table

In the entry for the IPv6 prefix, click **Delete**.

Command line

1. Show the IPv6 source address selection policy table.

```
eth 1 ipv6_lan 2 ipv6policy print
```

2. (Optional) To modify the IPv6 source address selection policy table, use the **ipv6ippolicy** command, specifying these parameters:

- **prefix:** The IPv6 prefix. The default depends on the instance. Destination IPv6 addresses are matched against the prefixes to find the entry with matching label.
- **label:** The label associated with the prefix configured into the same instance.

```
ipv6ippolicy 0 label 3
```

3. If you changed the policy table, save your configuration changes.

```
config 0 save
```

Show DHCPv6 server status

Command line

Use the command **dhcpv6_server status**.

```
dhcpv6_server status
```

```
ETH 1 DHCPv6 server status:  
Server DUID: 00-03-00-01-00-04-2d-f3-e7-32  
Preference value: 0
```

```
OK
```

Show DHCPv6 client status

Command line

Use the command **dhcpv6_client status**. For example:

```
dhcpv6_client status

ETH 0 DHCPv6 client status:
  Client DUID: 00-03-00-01-00-04-2d-05-ed-00
  DNS server: 2620:21:6000:800:8::1
  DNS server: 2620:21:6000:800:8::2
  SOL_MAX_RT: default
  INF_MAX_RT: default
  Server DUID: 00-01-00-00-55-e1-3c-f5-00-50-56-89-16-65
  Reconfigure accept: false
- IA for Non-temporary Addresses
  IAID: 0d000000
  T1: 8102
  T2: 21062
- IA Address
  IPv6 address: 2620:21:6000:1400:7468:6843:a5c9:57a6
  Preferred lifetime: 29702
  Valid lifetime: 72902
- IA for Prefix Delegation
  IAID: 0d000000
  T1: 0
  T2: 0

OK
```

Use DHCPv6 to learn IPv6 addresses

You can configure the router to use DHCPv6 to learn an IPv6 address, DNS addresses, and delegated prefixes from a DHCPv6 server. There are several options for learning IPv6 addresses from a DHCPv6 server:

- **Solicit:** The DHCPv6 client sends a **Solicit** message to the DHCPv6 servers to obtain the address of a neighboring DHCP Agent, and to obtain one or more addresses for DHCP servers which the DHCP Agent is configured to advertise.
- **Renew:** The DHCPv6 client sends a **Renew** message to the DHCPv6 server that originally provided the client's addresses and configuration parameters, to renew the addresses for DHCPv6 servers.
- **Release:** The DHCPv6 client sends a **Release** message to the DHCPv6 server that assigned addresses to the client, indicating that the DHCPv6 client will no longer use one or more of the assigned IPv6 addresses.



Command line

Use the command **dhcpv6_client**, specifying the requested action for the DHCPv6 client to perform.

```
dhcpv6_client solicit|renew|release <entity> <instance>
```

where **solicit**, **renew**, and **release** perform the IP address learning actions described above.

For example,

```
dhcpv6_client renew eth 0
```

Use the Neighbor Discovery Protocol (NDP) cache

Command line

The `ndp -a <entity> <instance>` command. Omitting the `<entity>` and `<instance>` parameters displays NDP caches for all interfaces.

```
ndp -a

ETH 0 NDP cache
Cache size: 50 entries
IP address          MAC address      State
fe80::5:73ff:fea0:e 00:05:73:a0:00:0e Stale
fe80::567f:eeff:fe5b:efbc 54:7f:ee:5b:ef:bc Stale
fe80::567f:eeff:fe5b:ed3c 54:7f:ee:5b:ed:3c Stale
fe80::c32:cb81:3f16:6305 64:31:50:99:fe:a9 Stale

ETH 1 NDP cache
Cache size: 50 entries
IP address          MAC address      State

ETH 2 NDP cache
Cache size: 50 entries
IP address          MAC address      State

ETH 3 NDP cache
Cache size: 50 entries
IP address          MAC address      State
OK
```

Delete a Neighbor Discovery Protocol (NDP) cache



Command line

Use the command **ndp -d <entity> <instance>**. Omitting the **<entity>** and **<instance>** parameters deletes all NDP caches for all interfaces.

```
ndp -d eth 0
```

Show the IPv6 routing table

IPv6 routing table information may display unfamiliar interface names that have a special meaning and handling. For example:

- **TCP 0** refers to the loopback interface. The routing table contains entries that point to this interface for any address that is owned by the device.
- **NULL 0** refers to the blackhole interface. Packets routed to this interface are dropped. The router adds a route pointing to the blackhole interface when a prefix is delegated to a WAN interface using DHCPv6. This means that the router drops all packets to that prefix. When the delegated prefix is subnetted to LAN interfaces, routes to those subnets are also added to the routing table. As the subnetted routes will have longer prefixes, matching packets will find those routes before the blackhole route. As a result, any packets to the delegated prefix that do not match packets to subnets assigned to LAN interfaces are dropped. Without the blackhole route, packets to unassigned subnets would probably be routed to the default route.



Command line

Use the **route6 print** command.

```
route6 print
```

Destination	Next Hop	Interface	Ref Count
::1/128	::	TCP 0	1
2620:21:6000:1400:7468:6843:a5c9:57a6/128	::	TCP 0	1
fe80::204:2dff:fe05:ed00/128	::	TCP 0	1
fe80::204:2dff:fe05:ed00/128	::	TCP 0	1
fe80::/64	::	ETH 0	1
fe80::/64	::	ETH 1	1
2620:21:6000:1400::/56	::	ETH 0	1
ff00::/8	::	ETH 0	1
ff00::/8	::	ETH 1	1
::/0	fe80::5:73ff:fea0:e	ETH 0	1

```
OK
```

Show IPv6 routing and address information

You can display IPv6 routing and address information for an interface or all interfaces, including:

- Information learned from RA messages, including routes, prefixes and DNS server addresses.
- A list of multicast groups the interface is listening on.
- A list of all learned DNS server addresses.
- A list of all delegated prefixes learned from upstream routers.
- All subnet prefixes assigned to LAN interfaces.



Command line

Use the command **ipv6 show <entity> <instance>**. Omitting the **<entity>** and **<instance>** parameters displays IPv6 routing and address information for all interfaces. For example:

```

ipv6 show

ETH 0
Default routers:
-----
Default router: fe80::5:73ff:fea0:e
Lifetime           : 1770
Hop limit          : 64
MTU                : 1500
Managed configuration: Yes
Other Configuration : No
Reachable time     : Unspecified
Retransmit interval : Unspecified
Prefix: 2620:21:6000:1400::/56
Valid lifetime     : 2591970
Preferred lifetime: 604800
On-link            : Yes
Auto config        : Yes

Multicast groups:
-----
ff02::1:ff05:ed00
ff02::1
ff02::1:ffc9:57a6

DNS servers:
-----
2620:21:6000:800:8::1
2620:21:6000:800:8::2

ETH 1

Multicast groups:
-----
ff02::1:fff5:ed00
ff02::1
ff02::2
ff02::1:2
OK

```

Show the IPv6 addresses assigned to an interface



Command line

Use the command **eth n status** to display status for the specified Ethernet interface instance. In the output, the IPv6 addresses currently assigned to the interface are listed after the existing IPv4 information.

```
eth 0 status

Activation Status:      Active
Connection Status:    Connected
Link:                  100Base-T Full-Duplex
Physical Port:         ETH 0
MAC:                   00 04 2D 05 ED 00
IP Address:            10.10.14.17
Mask:                  255.255.255.0
DNS Server:            10.10.8.62
Secondary DNS Server:  10.10.8.64
Gateway:               10.10.14.1
DHCP Server:           10.10.8.15
Lease Remaining (mins): 577
Assigned addresses:
                       2620:21:6000:1400:7468:6843:a5c9:57a6
                       fe80::204:2dff:fe05:ed00

OK
```

Support for IPv6 packets in firewall rules

There are several areas in the firewall rules syntax for handling IPv6 packets. For more information on these changes and detailed parameter descriptions, see [Firewall](#).

- Firewall rules can now specify IPv6 addresses. You can specify an IPv6 address anywhere you can specify an IPv4 address. However, you cannot use IPv4 and IPv6 addresses together in a single rule.
- Address/port translation is not supported with IPv6 packets. In rules, avoid mixing address translation with IPv6-specific keywords. See [Specifying IP addresses and ranges in firewall rules](#).
- In the [\[action\]](#) firewall script field:
 - In the **block** action, the optional field **return-icmpv6** causes an ICMPv6 packet to be returned from the interface from which that packet was received.
 - If a rule specifies **action dscp**, the traffic class portion of the IPv6 header is modified with the DSCP value.
- Several [\[options\]](#) keywords are allowed with rules for IPv4 packets: **oneroute**, **onvlan**, **onvrf**, **roteto**, and **oosed**. Using these keywords implies that the rule should only match on IPv4 packets.
- In the [\[version\]](#) firewall script field, you can specify IP version to which the rule applies: IPv4 or IPv6.
- In the [\[tos\]](#) firewall script field, for IPv6 packets, the traffic class field in the IPv6 header is checked.
- The [\[proto\]](#) firewall script field has an **icmpv6** option.
- For the [\[inspect-state\]](#) firewall script field that performs stateful inspection:
 - None of the **oos** options are supported for IPv6 packets.
 - You can use the **inspect-state** option with the following ICMPv6 packet types:

ICMPv6 type	Matching ICMPv6 type
Echo	Echo reply

- You can filter packets based on ICMPv6 codes, using the **[icmpv6]** field. See [Set filters in firewall rules](#).

Configure PPP and external modems

Point-to-Point Protocol (PPP) is a standard protocol for transporting data from point to multipoint networks (such as IP) across point-to-point links (such as a serial or ISDN connection). This functionality is essential for dial-up Internet access.

As data is transferred across IP networks in synchronous format, the router supports asynchronous to synchronous PPP conversion. This allows asynchronous terminals connected to the routers to communicate with remote synchronous PPP devices. Normally, this is carried out using a single ISDN B-channel so that data can be transferred at speeds up to **64** Kbps. This is known as ASYNC to SYNC PPP operation and is supported as standard by most terminal adapters. To use ASYNC to SYNC PPP operation all that is necessary is to ensure that the PPP protocol is bound to the ASY port to which the terminal or PC is connected. (see **Configuration > Network > Interfaces > Serial**).

Note To use ASYNC to SYNC PPP, the attached terminal must also support PPP (Windows dial-up networking supports PPP).

In addition to ASYNC to SYNC operation (where the router only converts the PPP from one form to another) the router can initiate its own PPP sessions. For example, the router uses this operation when:

- The router is configured as a router to connect an Ethernet network to the Internet via ISDN or W-WAN.
- The router is answering an incoming ISDN call with PPP either for remote management or remote access to the Ethernet network to which the router is connected.
- The router is accessed locally through the serial port for configuration purposes by setting up a Windows Dial-Up-Networking connection to the phone number **123**.

Note Except for MLPPP, the parameters in this section are only relevant when the router is generating the PPP. They are not relevant for ASYNC to SYNC PPP operation.

The router also supports Multi-link PPP (MLPPP). MLPPP uses both ISDN B-channels simultaneously (and two PPP instances), to provide data transfer speeds up to **128** Kbps for applications such as email or establishing a point-to-point connection between two routers.

Web

Go to **Configuration > Network > Interfaces > Advanced**. The **Configuration > Network > Interfaces > Advanced** menu has the following sub-menu options:

- **External Modems**
- **PPP Mappings**
- **PPP *n***

Configure external modem support

Note The PPP `use_modem` field has been altered so the value indicates which modem type to use. Value **1** indicates use of the GPRS modem. Value **2** indicates use of the external modem. By including enough modem call control instances, you can perform multilink PPP over multiple external modems.

Web

- Go to **Configuration > Network > Interfaces > Advanced > External Modems**. The **External Modems** page contains external modem parameters. External modem support added to GPRS builds. It is now possible to have a GPRS build that can also make outgoing PPP connections via an external modem. It is also possible to answer incoming calls via an external modem.

- Configure external modem parameters:

ASY Port

The physical **ASY** port for the external modem.

W-WAN mode

Enables W-WAN mode.

Initialisation string n

These parameters (**Initialisation string 1**, **Initialisation string 2**, **Initialisation string 3**) allow you to specify a number of command strings that are sent to the wireless module each time a wireless connection is attempted. You can use these parameters to set non-standard wireless operating modes.

Each string is prefixed with the characters **AT** before being sent to the wireless module and they are sent to the wireless module in the order specified until an empty string is encountered. For example, **Initialisation string 3** will not be sent unless **Initialisation string 1** and **Initialisation string 2** are both specified. Initialization strings are not normally required for most applications as the router will normally be preconfigured for correct operation with most networks.

Hang-up string

In a typical wireless application the connection to the network is **always on** and under normal circumstances it is not necessary to hang-up the wireless module. Under certain circumstances however, the router may use the **ATH** command to try and disconnect the wireless module from the network, such as if an incorrect APN has been specified and the module is unable to attach to the network correctly.

This parameter allows you to specify an alternative hang-up string that is sent to the wireless module when disconnecting a call. As with the Initialization strings, it is not necessary to include the **AT** as this is inserted automatically by the router.

Post hang-up string

Additional **AT** commands that are sent to the wireless module after it has been disconnected. As with the Initialization strings, it is not necessary to include the **AT** as this is inserted automatically by the router.

Listening init string

The listening initialization string parameter for external modems.

Listening init interval (secs)

The listening init string is sent at intervals specified by a listening init interval parameter.

Maximum RING count before answering incoming call

The count of the maximum number of rings before answering incoming call can be set in this field. The default value is **0**.

Minimum RING count before answering incoming call

The count of the minimum number of rings before answering incoming call can be set in this field. The default value is **0**.

3. Click **Apply**.



Command line

Command	Instance	Parameter	Values	Equivalent web parameter
modemcc	n	asyport	0-255 (Default: 255)	
modemcc	n	init_str	Free text field	Initialisation string 1
modemcc	n	init_str1	Free text field	Initialisation string 2
modemcc	n	init_str2	Free text field	Initialisation string 3
modemcc	n	hang_str	Free text field	Hang-up string
modemcc	n	posthang_str	Free text field	Post Hang-up string
modemcc	0	linit_str	Free text field	Listening init string
modemcc	0	linit_int	0-2147483647	Listening init interval (secs)

Configure PPP mappings

Web

1. Go to **Configuration > Network > Interfaces > Advanced > PPP Mappings**.
2. Associate functions with PPP interfaces. The **PPP Mappings** page contains two columns of as many interfaces as are supported by the router (this varies between models). Each row in the column contains a drop-down list box for selecting functions to associate with each PPP instance. The PPP instance number is the left-most column. For example, to assign a W-WAN interface to PPP instance **3**, select **Mobile SIM1 or SIM2** from the drop-down box to the right of instance **3**. If a W-WAN interface is fitted to the router, this is the default mapping.
3. Click **Apply**.

▼ **PPP Mappings**
 This page defines the underlying interface each PPP interface uses
PPP Interface

0	Not Assigned ▼
1	Mobile SIM1 or SIM2 ▼
2	Not Assigned ▼
3	Not Assigned ▼
4	Not Assigned ▼
5	Not Assigned ▼
6	Not Assigned ▼
7	Not Assigned ▼
8	Not Assigned ▼
9	Not Assigned ▼
10	Not Assigned ▼
11	Not Assigned ▼
12	Not Assigned ▼
13	Not Assigned ▼
14	Not Assigned ▼
15	Not Assigned ▼
16	Not Assigned ▼
17	Not Assigned ▼
18	Not Assigned ▼
19	Not Assigned ▼

Apply

4. Click **Apply**.

Multilink PPP parameters

Some TransPort routers support multilink PPP. This section describes the configuration of MLPP functionality.

The PPP interface must be configured with **Always On** mode enabled and an AODI NUA.

Desired local ACCM c

The Asynchronous Control Character Map (ACCM). The default value of **0x00000000** should work in most cases. Changing this value is for advanced users only.

Desired remote ACCM c

The ACCM for the remote peer. As above, the default value of **0xffffffff** should work in most cases and should only be changed if you know you need to use other characters.

Username

The username for logging on to the remote system.

Password

The password for authentication with the remote system when using MLPP. This password is for both B-channel PPP connections.

Confirm password

When changing the password, type the new password into this text box. The router checks that both fields are the same before changing the value.

Enable remote CHAP authentication

When enabled, causes the router to authenticate itself with the remote system using CHAP. If this parameter is set, the connection will fail if authentication fails. Generally, this setting should be left disabled.

Enable short sequence numbers

When enabled, enables the use of 12-bit data packet sequence numbers, rather than the more usual 16-bit data packet sequence numbers.

Bring up the second ISDN B-channel

Never

When selected, causes the router not to activate the second B-channel.

When the data rate is greater than n bytes/sec for s seconds

When selected, the two associated text boxes become enabled and allow the user to enter the desired data rate (default **2000** bytes/second) that will trigger activation of the second B-channel and the period for which the data rate exceeds that value, before the channel is activated.

Drop the second ISDN B-channel

When the connection is terminated

When selected, the second B-channel is only deactivated when the connection is terminated.

When the data rate is less than n bytes/sec for s seconds

When selected, the above two text boxes are enabled. The value in the left-hand one specifies the data rate below which the traffic must fall before the secondary B-channel will be deactivated. The

second box contains the time in seconds for which the data rate must be below threshold before the second B-channel is deactivated.

Note The following parameters are for use with **Always On Dynamic ISDN**.

Bring up the first ISDN B-channel

When the data rate is greater than n bytes/sec for s seconds

When Always On mode is enabled, these two settings specify the data rate and duration for which the data rate must be sustained before the B-channel is activated.

Drop the first ISDN B-channel

When the data rate is less than n bytes/sec for s seconds

When **Always On** mode is enabled, these two settings specify the data rate below the traffic must fall and the duration for which it is below the threshold before the B-channel is deactivated.



Command line

Command	Instance	Parameter	Values	Equivalent web parameter
mlppp	0	l_accm	0x00000000-0xFFFFFFFF	Desired local ACCM
mlppp	0	r_accm	0x00000000-0xFFFFFFFF	Desired remote ACCM
mlppp	0	username	Valid username	username
mlppp	0	password	Valid password	password
mlppp	0	epassword	Encrypted password	None-this parameter is not configurable
mlppp	0	r_chap	on, off	Enable remote CHAP authentication
mlppp	0	l_shortseq	on, off Default off	Enable short sequence numbers
mlppp	0	up_rate	0-2147483648 Default 2000	When the data rate is greater than n bytes/sec
mlppp	0	up_delay	0-2147483648 Default 10	for s seconds
mlppp	0	down_rate	0-2147483648 Default 1000	When data rate is less than n bytes/sec
mlppp	0	down_delay	0-2147483648 Default 10	for s seconds
mlppp	0	dup_rate	0-2147483648 Default 500	When data rate is greater than n bytes/sec

Command	Instance	Parameter	Values	Equivalent web parameter
mlppp	0	dup_delay	0-2147483648 Default 5	for s seconds
mlppp	0	dtdown_rate	0-2147483648 Default 500	When data rate is less than n bytes/sec
mlppp	0	dtdown_delay	0-2147483648 Default 5	for s seconds

Configure PPP parameters

When setting up a Point-to-Point Protocol (PPP) connection, you may need to adjust the PPP configuration parameters. Generally, however, you can leave these parameters at their default values.

Web

1. Go to **Configuration > Network > Interfaces > Advanced > PPP 0 - 9**.
2. Configure PPP configuration parameters as needed:

Load answering defaults

Clicking this button causes the router to read the default PPP answering default parameters from a default configuration stored in memory.

Load dialing defaults

Clicking this button causes the router to read the PPP dialing parameters from a default configuration stored in memory.

Description

A description of the PPP instance that may make it easier to refer to. For example, the PPP instance to connect to an ISP could be named **MyISP**.

This PPP interface will use

If the PPP mappings have been set up previously using the PPP mappings page, this box will contain the name of the protocol that has been assigned to this PPP instance. If the mapping has not been set up previously and if no default mappings apply, the value for this setting should be **Not Assigned**. Select the required the required physical interface from the drop-down selection box.

Dial out using numbers

To allow the router to automatically make outgoing calls, the ISDN number must be specified. The four text boxes allow four telephone numbers to be entered. The first one is required, the others are optional, and the router uses the others in rotation. These numbers can be the number of the Internet Service Provider (ISP) or another router.

Dial out using numbers:	<input type="text"/>	<input type="text"/>	<input type="text"/>
Prefix:	<input type="text"/>	to the dial out number	
Username:	<input type="text"/>		
Password:	<input type="text"/>		
Confirm password:	<input type="text"/>		

Prefix n to the dial out number

When making outgoing PPP calls, the value specified in this text box is inserted before the actual number being called. This may be required if a PABX system is in use which requires a prefix to use to get an outside line. For example, when using AODI or BACP, the remote peer may provide a number to use for raising an additional B-channel to increase the bandwidth. However, such a number will not normally include the digits needed to connect to an outside line via a PABX.

Username

The username to use for MLPPP login.

Password

The password to use for MLPPP login. This password is for both B-channel PPP connections.

Confirm password

Type the password in this text box to confirm that the password has been correctly typed in.

Note The following three radio buttons control how the IP address for the router is assigned.

Allow the remote device to assign a local IP address to this router

When this radio button is selected, the remote peer will assign this PPP interface an IP address.

- Allow the remote device to assign a local IP address to this router
- Try to negotiate to use as the local IP address for this router
- Use as the local IP address for this router (i.e. not negotiable)

Try to negotiate a.b.c.d as the local IP address for this router

If it would be useful, but not essential, to have a predefined IP address for the interface, the second radio button should be selected and the desired IP address entered into the text box to the right.

Use a.b.c.d as the local IP address for this router

If it is essential that the PPP interface has a specific IP address, this radio button should be selected and the IP address entered into the text box.

Use mask a.b.c.d for this interface

The default value in this text box will normally work, and should only be changed if it is known that the default is not appropriate. Since PPP is a peer-to-peer protocol, this value is appropriate in most situations.

Use mask for this interface

Use the following DNS servers if not negotiated

Primary DNS server:

Secondary DNS server:

DNS Port:

Attempt to assign the following IP configuration to remote devices

Assign remote IP addresses from to

Primary DNS server:

Secondary DNS server:

Use the following DNS servers if not negotiated

Sets primary and DNS servers to use if a DNS server is not assigned as part of the PPP negotiation and connection process.

Primary DNS server

The IP address of the primary DNS server to use if a DNS server is not assigned as part of the PPP negotiation and connection process. It is fairly common practice for the DNS server to be assigned automatically by the ISP when making a connection.

Secondary DNS server

The IP address of the secondary DNS server to use if one is not automatically assigned by the remote peer.

DNS Port

The network port number of the DNS server.

Attempt to assign the following IP configuration to remote devices

When enabled, displays following four configuration parameters, which control how the PPP instance assigns an IP address to a connecting remote peer. The primary and secondary DNS server addresses will also be sent to the remote peer

Assign remote IP addresses from a.b.c.d to a.b.c.d

The IP addresses in these text boxes define the pool of IP addresses to assign to remote peers during the IP protocol configuration phase of the PPP negotiation process.

Primary DNS server

The IP address of the primary DNS server that the remote peer should use when making DNS requests over the link.

Secondary DNS server

The IP address of the secondary DNS server that the remote peer should use when making DNS requests, should the primary server be unavailable.

Request packet data connection

When enabled, causes the PPP instances to request a connection for sending a data packet.

Request packet data connection

Allow this PPP interface to answer incoming calls
 Only allow calling numbers ending with

Close the PPP connection after seconds
 if it has been up for minutes in a day
 if it has been idle for hrs mins secs

Alternative idle timer for static routes seconds
 if the link has not received any packets for seconds
 if the negotiation is not complete in seconds

Enable NAT on this interface
 IP address IP address and Port
 NAT Source IP address:

Enable IPsec on this interface
 Keep Security Associations (SAs) when this PPP interface is disconnected
 Use interface for the source IP address of IPsec packets

Enable the firewall on this interface

Remote management access:

Allow the PPP interface to answer incoming calls

When enabled, causes the PPP instance to answer an incoming call.

Only allow calling numbers ending with n

When set to answer calls, this setting provides a filter for ISDN sub-addresses. This value is blank by default but when the PPP instance is set to answer calls, only numbers having trailing digits that match the sub-address value in this test will be answered. So for example, if this value is set to **123**, only calls from numbers with trailing digits that match this value will be answered, for example, **01942 605123**.

Close the PPP connection after s seconds

The maximum time that the link will remain active in any one session. After this time, the link will be deactivated.

if it has been up for m minutes in a day

The router deactivates the PPP instance after it has been active for the value specified in this text box.

if it has been idle for h hrs m mins s secs

The router deactivates the PPP instance after the time specified in these text boxes if it detects that the link has not seen traffic.

Alternative idle timer for static routes s seconds

An alternative inactivity timeout for use in conjunction with the **Make PPP n interface use the alternative idle timeout when this route becomes available** parameter on the **Configuration > Network > IP Routing/Forwarding > Static Routes > Routes n > Advanced** web page. The router uses this timeout until the PPP instance next deactivates only. After that, it uses the normal timeout value.

If the link has not received any packets for s seconds

The amount of time the router waits without receiving any PPP packets before disconnecting. The timer is reset with each received PPP packet.

if the negotiation is not complete in s seconds

The maximum time, in seconds, allowed for the PPP negotiation to complete. If negotiations have not completed within this period, the interface is deactivated.

Enable NAT on this interface

When enabled, causes the router to apply Network Address Translation (NAT) to IP packets on this interface. When enabled, the following additional parameters appear:

IP address/IP address and Port

These radio buttons select whether IP address translation only should be applied or whether port number translation should also be applied to IP packets.

NAT Source IP address a.b.c.d

The IP address of the interface to use as the source address in IP packets crossing the NAT interface.

Enable IPsec on this interface

When enabled, causes the router to use the IPsec protocol to secure the connection. Enabling this setting displays the following additional parameters:

Keep Security Associations (SAs) when this PSTN interface is disconnected

When enabled, causes the router to maintain (such as not flush) the SA when the interface becomes disconnected. The normal behavior is to remove the SAs when the interface becomes disconnected.

Use interface x,y for the source IP address of IPsec packets

If it is required to use another interface (such as not the interface currently being configured) as the source address for IPsec packets, this may be achieved by selecting the desired interface from the drop-down list and typing the desired interface instance number into the adjacent text box.

Enable the firewall on this interface

Enabling this setting causes the router to apply the firewall settings to traffic using this interface. When debugging connections issues it is often helpful to make sure this setting is

disabled, because incorrect firewall rules prevent a connection from passing network traffic. If the connection works when the firewall is turned off but fails when turned on, a good place to start checking parameters would be in the firewall settings page, **Configuration > Security > Firewall**.

Remote management access

Can be set to **No restrictions**, **Disable management**, **Disable return RST**, **Disable management and return RST**.

- When set to **No restrictions**, users on this interface can access the router's Telnet, FTP, and web services for the purpose of managing the router.
- When set to **Disable management**, users on this interface are prevented from managing the router via Telnet, FTP, or the web interface.
- For **Disable return RST**, whenever a router receives a TCP SYN packet for one of its own IP addresses with the destination port set to an unexpected value, such as a port that the router would normally expect to receive TCP traffic on, it will reply with a TCP RST packet. This is normal behavior. However, the nature of internet traffic is such that whenever an internet connection is established, TCP SYN packets are to be expected. As the router's PPP inactivity timer is restarted each time the router transmits data (but not when it receives data), the standard response of the router to SYN packets, such as transmitting an RST packet, will restart the inactivity timer and prevent the router from disconnecting the link even when there is no genuine traffic. This effect can be prevented by using the appropriate commands and options within the firewall script. However, on Digi 1000 series routers, or where you are not using a firewall, the same result can be achieved by selecting this option, such as when this option is selected the normal behavior of the router in responding to SYN packets with RST packets is disabled. The option will also prevent the router from responding to unsolicited UDP packets with the normal ICMP destination unreachable responses.
- The **Disable management and return RST** option prevents users from managing the router via the Telnet, FTP, and web interfaces and also disables the transmission of TCP RST packets as above.

3. Click **Apply**.



Command line

Command	Instance	Parameter	Values	Equivalent web parameter
ppp	n	name	Free text field	Description
ppp	n	l1iface	The layer 1 interface, such as Async Port, PPTP, W-WAN	This PPP interface will use
ppp	n	l1nb	Layer 1 Interface number Default: 0	This PPP interface will use value

Command	Instance	Parameter	Values	Equivalent web parameter
ppp	n	l2face	The lower layer interface, such as. LAPB, LAPD, XOT	This PPP interface will use
ppp	n	l2nb	Lower layer interface number. Default: 0	
ppp	n	aodinua		
ppp	n	phonenum	up to 25 digits	Dial out using numbers
ppp	n	ph2	up to 25 digits	Dial out using numbers
ppp	n	ph3	up to 25 digits	Dial out using numbers
ppp	n	ph4	up to 25 digits	Dial out using numbers
ppp	n	prefix	0-9999999999	Prefix n to the dial out number
ppp	n	username	Valid username	Username
ppp	n	password	Valid password	Password
ppp	n	epassword	The encrypted password	None-this parameter is not configurable
ppp	n	r_addr	Default 0.0.0.0 set automatically	Allow the remote device to assign a local IP address to this router
ppp	n	IPaddr	Valid IP address a.b.c.d	Try to negotiate a.b.c.d as the local IP address for this router
ppp	n	l_addr	Valid IP address Default 1.2.3.4	Use a.b.c.d as the local IP address for this router
ppp	n	mask	Valid IP address Default 255.255.255.255	Use mask a.b.c.d for this interface
ppp	n	DNSserver	Valid IP address	Primary DNS server
ppp	n	secDNS	Valid IP address	Secondary DNS server
ppp	n	DNSport	Valid IP address Default 53	DNS Port
ppp	n	IPmin	Valid IP address Default 10.10.10.10	Assign remote IP addresses from a.b.c.d to a.b.c.d

Command	Instance	Parameter	Values	Equivalent web parameter
ppp	n	IPrange	0-255 Default 5	Assign remote IP addresses from a.b.c.d to a.b.c.d Note that these are not directly equivalent. This address is obtained by adding the range value to the minimum.
ppp	n	transDNS	Valid IP address	Primary DNS server
ppp	n	sectransDNS	Valid IP address	Secondary DNS server
ppp	n	cingnb	up to 25 digits	Only allow numbers ending with n
ppp	n	msn	up to 9 digits	with ISDN MSN ending with n
ppp	n	sub	up to 17 digits	with ISDN sub-address ending with n
		cli		
ppp	n	maxup	0-2147483648	Close the PPP connection after s seconds
ppp	n	maxuptime	0-2147483647	if it has been up for m minutes in a day
ppp	n	timeout	Default 300s (5 minutes)	if it has been idle for h, m, s
ppp	n	timeout2	0-2147483648	Alternative idle timer for static routes s seconds
ppp	n	rxtimeout	0-2147483648	if the link has not received any packets for s seconds
ppp	n	maxneg	0-2147483648	if the negotiation is not complete in s seconds
ppp	n	do_nat	0, 1 0=Off 1=On	Enable NAT on this interface
ppp	n	natip	Valid IP address a.b.c.d	NAT Source IP address a.b.c.d
ppp	n	ipsec	0, 1 0=Off 1=On	Enable IPsec on this interface

Command	Instance	Parameter	Values	Equivalent web parameter
ppp	n			Keep Security Associations (SAs) when this PPP interface is disconnected
ppp	n	ipsecent	Default PPP Ethernet	Use interface x,y for the source address of IPsec packets
ppp	n	ipsecadd	Valid interface number	Use interface x,y for the source address of IPsec packets
ppp	n	firewall	off, on	Enable the firewall on this interface
ppp	n	qos	off, on	Enable QoS on this interface
ppp	n	use_modem	0, 1	This PPP interface will use
ppp	n	cdma_backoff	0, 1 Default: 1	None
ppp	n	ndis	off, on	Request packet data connection
ppp		nocfg	0, 1, 2, 3	Remote management access 0=No restrictions 1=Disable management 2=Disable return RST 3=Disable management and return RST
ppp	n	igmp	off, on	Enable IGMP
ppp	n	ifspeed	64000 bps	None. CLI command only. The ppp command allows configuring the interface speed for reporting in SNMP.
ppp	n	vrf	integer	None. CLI command only.
ppp	n	vrfexport	integer	None. CLI command only.

Configure mobile PPP parameters

Mobile telephone modules fitted into the router use PPP to connect to the network and send and receive traffic. This section describes parameters relevant to setting up a mobile telephone module.

Web

1. Go to **Configuration > Network > Interfaces > Advanced > PPP 0 - 9 > PPP n > Mobile**.
2. Configure mobile PPP parameters as needed:

Mobile

Use SIM Any SIM 1 SIM 2

Detach W-WAN if the link fails (e.g. Failed to get PPP Ping responses)

Detach W-WAN between connection attempts

Use SIM Any, SIM1, SIM2

Select which of the installed SIM cards the module should use.

Detach W-WAN if the link fails

When enabled, causes the router to issue the command to detach the mobile telephone module from the wireless network if it detects that the link has failed. Link failure is detected by a PPP ping response timer or by a firewall request.

Detach W-WAN between connection attempts

Controls whether the module stays attached to the network if multiple connection attempts are required to establish a connection. This functionality may be useful if the connection to the mobile telephone network is not very reliable. Connecting to the mobile telephone network to send and receive data is a two-stage process. The first stage is where the module signals its wish to join the network and is accepted by the local cell. The second stage involves negotiating the link parameters and transferring data. Sometimes it may be necessary to cleanly detach from the network in order to start the process from the ground up.

3. Click **Apply**.

Command line

Command	Instance	Parameter	Values	Equivalent web parameter
ppp	n	gprs_sim	0-2 0=Any 1=SIM1 2=SIM2	Use SIM, Any, SIM 1, SIM 2
ppp	n	detach_on_fail	off, on	Detach W-WAN if the link fails
ppp	n	detach	off, on	Detach W-WAN between connection attempts

Configure advanced PPP parameters

Normally, advanced PPP parameters do not need to be changed from their defaults.

Web

1. Go to **Configuration > Network > Interfaces > Advanced > PPP 0 - 9 > PPP n > Advanced**.
2. Configure advanced PPP parameters as needed:

Metric

The connected metric of the interface. The default metric of a connected interface is **1**. By allowing the interface to have a higher value (lower priority), static routes can take precedence over interfaces. For normal operation, leave this setting unchanged.

Allow this PP interface to settle for s x 100 milliseconds

On wireless links, it is possible that the initial packets sent to the interface by the TCP layer may be dropped by the network if they are sent too quickly after PPP negotiation has completed. This setting defines the delay in notification sent to the TCP layer that PPP negotiation has completed.

Enable “Always On” mode of this interface

If the **Always on** option is available on the interface, enabling this setting reveals the following two radio buttons. When this functionality is enabled, the router will automatically try to reconnect after about **10** seconds if the link becomes disconnected. This parameter should be enabled when using AODI or W-WAN.

On

Default action, the interface will always try and raise this PPP link.

On and return to service immediately

These two radio buttons enable the **Always on** functionality and additionally the facility to return to the in-service state after a disconnect event.

Put this interface “Out of Service” when an always-on connection attempt fails

Normally, always-on interfaces will not go out of service unless they have connected at least once. When enabled, this setting causes the router to put the interface out of service even if the first connection attempt fails.

Attempt to re-connect after s seconds

The length of time, in seconds, the router should wait after an **Always on** PPP connection has been terminated before trying to re-establish the link.

If a PPP interface that would be inhibited by this PPP is connected, attempt reconnection after s seconds

The value in this setting takes precedence over the previous parameter when another PPP instance that is usually inhibited by this one is connected. You can use this parameter to reduce the connection retry rate when a lower priority PPP instance is connected.

Wait s seconds after power-up before activating this interface

The initial delay the router applies before activating the PPP instance after power-up. After the initial power-up delay the normal always-on activation timers apply. If set to **0**, no delay is applied.

Keep this interface up for at least s seconds

The minimum period that the PPP interface should remain available. This means that even if the link becomes inactive before this period expires, the connection will remain open.

Enable Multilink PPP on this interface

When enabled, enables the multilink PPP capability of the router. (See above for configuration details).

Click here to assign a timeband to this interface

Clicking this link redirects the browser to the timeband configuration page **Configuration > Network > Timebands**.

Add a route to a.b.c.d if the peer's IP address is not negotiated

Normally, the IP address for a device connecting to a remote peer is assigned by the remote peer. If this is not the case then the router will need a route to the remote peer. This setting is set to the IP address of the remote peer so that it can be added to the routing table.

Enable DNS inbound blocking

Enables or disables blocking DNS requests on the PPP interface, to prevent the router from responding to DNS requests over this interface.

Forward IP broadcasts over this interface if the interface is on the same IP network as an Ethernet interface

When enabled, causes the router to route broadcast packets to and from Ethernet interfaces. This will only occur if the PPP instance has issued an address which is part of the Ethernet interface network.

Send LCP echo request packet to the remote peer

When enabled, displays the configuration parameters that cause the router to send Link Control Protocol (LCP) packets to the remote peer at specified intervals. This feature can be useful for keeping a link active (W-WAN, for example).

Send LCP echo requests every s seconds

The value in this text box sets the interval at which to send the packets. When set to **0**, transmission of LCP packets is disabled.

Disconnect the link after n failed echo requests

The number of consecutive failed echo requests allowed before the router terminates the link. When set to **0**, this functionality is disabled, such as the router will not terminate the link if the LCP echo requests do not elicit a response from the remote.

Generate Heartbeats on this interface

When enabled, displays the configuration options controlling how the router sends heartbeat packets. Generating a valid configuration enables the router to send heartbeat packets to the

specified destination. Heartbeat packets are UDP packets containing information about the router and which may include status information for locating its current dynamic IP address. Heartbeats can also contain GPS position information and mobile telephone module information.

Send Heartbeat messages to IP address a.b.c.d every h hrs, m minutes, s secs

The left-hand text box contains the IP address of the destination for the heartbeat packets. The remaining text boxes specify the desired interval between sending heartbeat packets.

Use interface x,y for the source IP address

Select of the source interface for the UDP heartbeats. Selecting an Ethernet source allows the packets to follow the routing table instead of being sent out from the PPP interface on which they are set.

Select transmit interface using the routing table

When enabled, causes the router to choose the best route from the routing table. If unchecked, the exit interface will be the interface on which the heartbeat is configured.

Include IMSI information in the Heartbeat message

When enabled, causes the router to include the IMSI of the wireless modem module in the heartbeat packet.

Include GPS information in the Heartbeat message

When enabled, causes the router to include the GPS co-ordinates in the heartbeat packet.

Generate Ping packets on this interface

When enabled, this setting causes the router to reveal the configuration parameters that enable the sending of ICMP echo request (ping) packets. You can use this feature as part of a backup interface strategy.

Send n byte pings to IP host a.b.c.d every h hrs, m mins, s secs

Controls how the ICMP echo requests are generated. The value in the left-hand text box specifies the number of data bytes in the echo request. Typical values are **32** or **64** octets. The IP host text box specifies the IP address of the host to which the ping packets are sent. The remaining parameters specify how often the ping should be sent.

Send pings every h hrs, m mins, s seconds if ping responses are not being received

These three text boxes specify the interval at which to send pings when more than one ping request is outstanding. When left at the default of **0**, this function is disabled.

Switch to sending pings to IP host a.b.c.d after n failures

These parameters allow for more reliable problem detection before failover occurs. If the value in the first text box is a valid IP address, and the value in the second text box is greater than **0**, when a ping failure is detected on the primary host address, this secondary host is tried. This is to ensure that should the primary host become unavailable for any reason and stops responding to the ICMP echo requests, the router will check an alternative IP address before initiating the failover procedure. The value in the second text box is the number of pings that should be allowed to fail before checking the secondary IP address.

Ping responses are expected within s seconds

When the value in this text box is set to a non-zero value, the router will wait for that specified interval for a response from a ping request before applying the timeout specified in the **Send pings every ... if ping responses are not being received setting** above. If the value is set to **0** (the default) then the router applies the timeout without modification.

Only send Pings when this interface is “In Service”

When enabled, causes the router to only send ICMP requests when the PPP instance is in service. The default setting is unchecked which means that ICMP requests are sent when the interface is in service and out of service.

New connections to resume with previous Ping interval

When enabled, causes the router to use the ping interval that was in force when the PPP interface last disconnected.

Reset the link if no response is received within s seconds

The period for which the router should wait before terminating the PPP connection if no response to the auto-pings has been received. This behavior is useful in the attempt to re-establish communications, since the router will automatically attempt to restart an always-on link that has been terminated. The router uses function primarily when IP traffic is being carried over a W-WAN link and when the associated PPP instance is configured into the always-on mode.

Use ETH 0 IP address as the source IP address

When enabled, causes the router to use the IP address of interface **ETH 0** as the source address for ICMP echo requests instead of the current IP address of the PPP interface.

Defer sending pings if IP traffic is being received

One of the uses for sending ICMP echo requests is as a keepalive mechanism. When this setting is enabled, the router defers sending the ping packets out if IP traffic is being received, since in this case, separate keepalives are not needed.

Limit the data transmitted over this interface

Some service providers impose a (usually monthly) limit on the amount of data sent over a link and levy additional charges if the limit is exceeded. This is fairly common practice for W-WAN links. When enabled, this setting causes the router to stop sending data on the interface when the preset data limit has been exceeded. The interface is unlocked manually by clicking the **Clear Total Data Transferred** button on the **Management > Network Status > Interfaces > Advanced > PPP > PPP n** page. Alternatively, it can be reset automatically on a certain day of the month.

Issue a warning event after n Kbytes/Mbytes/GBytes

The value in this text box is the amount of traffic which will cause a warning event to be generated in the event log stating that the specified amount of data has been transferred. The units are specified by a drop-down list, having the following options; **KBytes**, **MBytes**, **GBytes**. For example, if the monthly tariff includes up to **5** MB of data before excess usage charges are levied, it would be useful to set this threshold to **4** MB. This would cause the router to create a warning entry in the event log once **4** MB of data had been transferred. You could use this event to trigger an email alert, SNMP trap or SMS alert message.

Stop data from being transmitted after n Kbytes/Mbytes/GBytes

The value in this text box specifies the total amount of data that may be transmitted by this PPP instance before the link is blocked for further traffic, and the value in the drop-down list specifies the units which are; **KBytes**, **MBytes**, **GBytes**.

Reset the data limit on the n day of the month

The day of the month on which the data limit is reset to **0**.

When the link disconnects, indicate that the connection failed if no IP packets were received

When the link disconnects, indicate that the connection failed if no IP packets were received.

Reset this interface after unanswered transmitted packets and the connection has been up for at least seconds

Reboot the router after consecutive resets

Reboot the router after consecutive connection failures

Reset this interface if n packets are transmitted and the connection has been up for at least s seconds

The values in these text boxes control the circumstances under which the link can be reset. If the number of packets text box has a value greater than **0**, the router will reset the link if that many IP packets have been transmitted but none have been received, and the link has been active for at least the value specified in the second text box.

Reboot the router after n consecutive resets

If the value in this text box is non-zero, the router reboots if the PPP link has been reset the specified number of times as a consequence of the value **n packets** (described above) being exceeded.

Reboot the router after n consecutive connection failures

If the value in this text box is non-zero, the router will reboot if it fails to establish a connection over this PPP instance after the specified number of consecutive attempts.

Use RADIUS for authentication when acting as a server**Use RADIUS instance****Allow this PPP interface to attempt to connect n times before allowing other PPP interfaces inhibited by this interface to connect**

The number of connection attempts this PPP instance is allowed to make before other PPP instances that are inhibited by this instance may make connection attempts.

If this PPP interface gets disconnected, allow it to attempt to reconnect n times before allowing other PPP interfaces inhibited by this interface to connect

On W-WAN routers, this setting specifies the number of times that a PPP instance which was connected and is then disconnected, is allowed to attempt to reconnect before other PPP instances that were inhibited by this PPP instance will be allowed to connect.

Inhibit this PPP interface if the following PPP instances n are Active | Active and not out of service | Not out of service | Connected and not out of service

Inhibition of this PPP interface may be controlled by the state of other PPP instances. This behavior is controlled by the options in this drop-down menu box.

If this PPP interface is inhibited and data needs to be sent

The options in this drop-down selection box control the behavior of the router in the situation where the PPP instance is in its inhibited state but there is data waiting to be sent over the interface. The options are:

Do not bring up interface

Leaves the situation as it is with the interface remaining inhibited.

Bring up interface and use normal idle period

Removes the inhibit state from the interface and uses the normal idle time associated with it to control when it deactivates.

Bring up interface and use idle period of s seconds

Causes the interface to become activated but rather than using the idle timer associated with the interface, specify the idle timeout.

Inhibit other PPP interface if this PPP interface is disconnected but operational

When enabled, enables this PPP instance to inhibit other PPP instances if it is operational but not currently active.

Attempt to negotiate DEFLATE compression on this interface

When enabled, causes the router to compress the data transferred over this link. When unchecked, compression is disabled. The effectiveness of data compression varies with the type of data but a typical ratio achieved for a mix of data such as web pages, spreadsheets, databases, text files and (uncompressed) image files would be between **2:1** and **3:1**. Using compression has the effect of increasing the effective throughput. Using compression may offer cost savings on a network where charges are based upon the amount of data transferred (such as W-WAN networks). If the data is already compressed (such as **.zip** files or **.jpg** images) then the compression algorithm detects this and sends the data without attempting further compression.

Attempt to negotiate MPPE encryption on this interface

When enabled, causes the router to attempt to negotiate Microsoft Point-to-Point Encryption (MPPE) with the remote peer. If the remote peer is unable to negotiate MPPE, negotiations will fail. When negotiated, the PPP instance will encrypt the PPP frames as per the MPPE specification.

MPPE key size

The values in this drop-down list select the length (in bits) of the encryption key. The options are:

- **Auto**
- **40 bits**
- **56 bits**
- **128 bits**

Auto indicates that the router will accept whatever the remote suggests. For the other values, the remote must accept and request the key size specified, else the PPP negotiations will fail.

Enable MPPE stateless mode

When this setting is enabled, the router negotiates stateless mode in which the session key is changed after the transmission of each packet. Stateless mode may be useful for lossy links.

Note MPPE does not provide authentication, only encryption. This is because the encryption keys are determined by the PPP engines themselves on start-up.

Use PPP m for processing CHAP

TCP transmit buffer size n bytes

When the value in this text box is set to a non-zero value, the router uses the value to set the size of the TCP buffer for transmitted packets. This is useful for slow and/or lossy connections such as satellite links. Setting this buffer to a low value will prevent the amount of unacknowledged data from getting too high. If retransmits are required, a smaller transmit buffer helps prevent retransmits flooding the connection.

3. Click **Apply**.



Command line

Command	Instance	Parameter	Values	Equivalent web parameter
ppp	n	metric	0-255	Metric
ppp	n	settledly	0-200	Allow this PPP interface to settle for s seconds after the connection has come up
ppp	n	aodion	0, 1, 2 0=disabled 1=enabled 2=On and return to service immediately	Enable “Always On” mode of this interface, On, On and return to service immediately
ppp	n	autoassert	0, 1, 2 0=no autoassert 1=autoassert with route up delay 2=autoassert with no route up delay	

Command	Instance	Parameter	Values	Equivalent web parameter
ppp	n	immoos	on, off	Put this interface “Out of Service” when an always-on connection attempt fails
ppp	n	rdoosdly	on, off	remote disconnect
ppp	n	aodi_dly	0-2147483647	Attempt to reconnect after s seconds
ppp	n	aodi_dly2	0-2147483647	If a PPP interface that would be inhibited by this PPP is connected, attempt to re-connect after s seconds
ppp	n	pwr_dly	0-2147483647	Wait s seconds after power-up before activating this interface
ppp	n	minup	0-2147483647	Keep this interface up for at least s seconds
ppp	n	multi	off, on	Enable Multilink PPP on this interface
ppp	n	netip	Valid IP address a.b.c.d	Add a route to a.b.c.d if the peer’s IP address is not negotiated
ppp	n	block_dns	on, off	Enable DNS inbound blocking
ppp	n	rbcast	off, on	Forward IP broadcasts over this interface if this interface is on the same IP network as an Ethernet interface
ppp	n	There is no explicit parameter to enable or disable this setting; it is disabled by disabling the ppp n echo n and ppp n echodropcnt n parameters.	off, on	Send LCP echo request packet to the remote peer
ppp	n	echo	0-2147483648	Send LCP echo requests every s seconds
ppp	n	echodropcnt	0-2147483648	Disconnect the link after n failed echo requests
ppp		None		Generate Heartbeats on this interface
ppp	n	hrtbeatip	Valid IP address a.b.c.d	Send Heartbeat messages to IP address a.b.c.d every h hrs, m mins, s secs

Command	Instance	Parameter	Values	Equivalent web parameter
ppp	n	hrtbeatint	0-2147483648	Send Heartbeat messages to IP address a.b.c.d every h hrs, m mins, s secs
ppp	n	hbipent	Blank, PPP, ETH Blank is default	Use interface x,y for the source IP address
ppp	n	hbipadd	Valid interface number 0-2147483648	Use interface x,y for the source IP address
ppp	n	hbiproute	off, on	Select transmit interface using the routing table
ppp	n	hbimsi	off, on	Include IMSI information in the Heartbeat message
ppp	n	hbgps	off, on	Include GPS information in the Heartbeat message
ppp	n	None	off, on	Generate Ping packets on this interface
ppp	n	pingsiz	0-2147483648	Send n byte pings to IP host a.b.c.d every h hrs, m mins, s secs
ppp	n	pingip	Valid IP address a.b.c.d	Send n byte ping to IP host a.b.c.d every h hrs, m mins, s secs
ppp	n	pingint	0-2147483648	Send n byte ping to IP host a.b.c.d every h hrs, m mins, s secs
ppp	n	pingint2	0-2147483648	Send pings every h hrs, m mins, s seconds if ping responses are not being received
ppp	n	pingip2	Valid IP address a.b.c.d	Switch to sending pings to IP host a.b.c.d after n failures
ppp	n	ip2count	0-2147483648	Switch to sending pings to IP host a.b.c.d after n failures
ppp	n	pingresp	0-2147483648	Ping responses are expected within s seconds
ppp	n	pingis	off, on	Only send Pings when this interface is "In Service"

Command	Instance	Parameter	Values	Equivalent web parameter
ppp	n	ping2cont	off, on	New connections to resume with previous Ping interval
ppp	n	pingdeact	0-2147483648	Reset the link if no response is received within s seconds
ppp	n	pingfreth0	off, on	Use ETH 0 IP address as the source IP address
ppp	n	pingresetint	off, on	Defer sending pings if IP traffic is being received
ppp	n	None - See dlwarnkb, dlstopkb, dlrstday parameters.	off, on	Limit the data transmitted over this interface
ppp	n	dlwarnkb	0-2147483647	Issue a warning event after n XBytes
ppp	n	dlstopkb	0-2147483647	Stop Data from being transmitted after n XBytes
ppp	n	dlrstday	0-255	Reset the data limit on the n day of the month
ppp	n			When the link disconnects, indicate that the connection failed if no IP packets were received
ppp	n	sscncnt	0-2147483648	Reset this interface if n packets are transmitted and the connection has been up for at least s seconds
ppp	n	sssecs	0-2147483648	Reset this interface if n packets are transmitted and the connection has been up for at least s seconds
ppp	n	lscnt	0-2147483648	Reboot the router after n consecutive resets
ppp	n	rebootfails	0-2147483648	Reboot the router after n consecutive connection failures
ppp	n	radius	off, on	Use RADIUS for authentication when acting as a server
ppp	n	radiuscfg		Use RADIUS instance

Command	Instance	Parameter	Values	Equivalent web parameter
ppp	n	acttries	0-255	Allow this PPP interface to attempt to connect n times before allowing other PPP interfaces inhibited by this interface to connect
ppp	n	pdacttries	0-255	If this PPP interface gets disconnected, allow it to attempt to reconnect n times before allowing other PPP interfaces inhibited by this interface to connect
ppp	n	inhibitno	0-2147483648	Inhibit this PPP interface if the following PPP instances n are Active, Active and not out of service, not out of service, Connected and not out of service
ppp	n	inhmode	0-3	Inhibit this PPP interface if the following PPP instances n are Active, Active and not out of service, not out of service, Connected and not out of service
ppp	n	actmode	off, on	Inhibit other PPP interface if this PPP is interface is disconnected but operational
ppp	n	trafficto	0-2147483648	If this PPP interface is inhibited and data needs to be sent do not bring up the interface, bring up interface and use normal idle period, bring up interface and use idle period of s seconds
ppp	n	deflate	0, 1 0=Off 1=On	Attempt to negotiate DEFLATE compression on this interface
ppp	n	mppe	off, on	Attempt to negotiate MPPE encryption on this interface
ppp	n	mppebits	0, 40, 56, 128 0=Auto	MPPE key size
ppp	n	mppeless	off, on	Enable MPPE stateless mode
ppp	n	other_local_PPP_mode	off, on	Use PPP for processing CHAP
ppp	n	other_local_PPP_inst		Use PPP n for processing CHAP
ppp	n	tcptxbuf	0-2147483648	TCP transmit buffer size n bytes

Command	Instance	Parameter	Values	Equivalent web parameter
ppp	n	pppdebug	off, On	
ppp	n	norxrst	off, on	None. This parameter can be used when a cellular module is connected to a network and has successfully negotiated an IP address, but cannot route any data. If set to on, the TransPort device will detect this condition and power cycle the cellular module. Default: off.
ppp	n	noremaddr	off, on	

Configure PPP negotiation

When PPP starts up, the devices at both ends of the link negotiate the link parameters to find a common subset that both devices can use. The negotiation may be summarized by saying that both ends send negotiation packets with the following message:

These are the values that I wish to use, and these are the values that I wish you to use.

Web

1. Go to **Configuration > Network > Interfaces > Advanced > PPP 0 - 9 > PPP n > PPP Negotiation**.
2. Configure PPP negotiation parameters as needed:

PPP Negotiation

Restrict the negotiation time to seconds
 Disconnect if the remote requests an IP address

Desired local ACCM: <input type="text" value="0x00000000"/>	Desired remote ACCM: <input type="text" value="0xffffffff"/>
Desired local MRU: <input type="text" value="1500"/> bytes	Desired remote MRU: <input type="text" value="1500"/> bytes

Request local ACFC <input checked="" type="checkbox"/>	Remote ACFC <input type="text" value="Allow"/>
Request local PAP authentication <input checked="" type="checkbox"/>	Request remote PAP authentication <input type="checkbox"/>
Request local CHAP authentication <input checked="" type="checkbox"/>	Request remote CHAP authentication <input type="checkbox"/>
Request local (VJ) compression <input checked="" type="checkbox"/>	Request remote (VJ) compression <input type="checkbox"/>
Request local PFC <input checked="" type="checkbox"/>	Remote PFC <input type="text" value="Allow"/>
Request BACP <input type="checkbox"/>	
Request callback <input type="checkbox"/>	Allow remote end to request callback <input type="text" value="Desired"/>

Allow this unit to authenticate using	Enabled <input type="text" value="Enabled"/>	Allow a remote unit to authenticate using	
CHAP-MD5	Disabled <input type="text" value="Disabled"/>	CHAP-MD5	<input checked="" type="checkbox"/>
MS-CHAP	Disabled <input type="text" value="Disabled"/>	MS-CHAP	<input checked="" type="checkbox"/>
MS-CHAPv2	Disabled <input type="text" value="Disabled"/>	MS-CHAPv2	<input checked="" type="checkbox"/>

Restrict the negotiation time to s seconds

The maximum time allowed for a PPP negotiation to complete. If negotiations have not completed in this time, the PPP instance is disconnected.

Disconnect if the remote requests an IP address

Disconnects the PPP link if the remote host requests an IP address from the router.

Desired local ACCM

The local Asynchronous Control Character Map which has the default value **0x00000000**. Changing this value is for advanced users.

Desired remote ACCM

The remote ACCM which has the default value **0xffffffff**. As above, the default will work in nearly all circumstances and should be changed only where really necessary.

Desired local MRU n bytes

The desired local Maximum Receive Unit (MRU), the default value of **1500** octets will work fine in most cases.

Desired remote MRU n bytes

The value in this text box is the desired MRU for the remote end of the link. The default value of **1500** octets will be fine in most cases.

Request local ACFC

When enabled, causes the router to request Address Control Field Compression (ACFC). When negotiated, the address/control fields are removed from the start of the PPP header.

Remote ACFC

When enabled, this setting causes the router to ask the remote device to request ACFC.

Request local PAP authentication

When enabled, causes the router to use the Password Authentication Protocol (PAP) before allowing a connection to be made. Generally, this parameter is enabled for incoming connections and disabled for outgoing connections.

Request remote PAP authentication

When enabled, causes the router to authenticate itself with the remote device using PAP. If this parameter is set, the connection will fail if authentication is not successful. Generally, this parameter is disabled.

Request local CHAP authentication

When enabled, causes the router to use the Challenge Handshake Authentication Protocol (CHAP) for local authentication. As with PAP, this parameter is generally enabled for incoming connections and disabled for outgoing connections.

Request remote CHAP authentication

As with PAP above, this setting controls whether or not the router should authenticate itself with the remote device using CHAP. The connection will fail if authentication fails. Generally, this parameter is enabled for outgoing connection and disabled for inbound connections.

Request local (VJ) compression

When enabled, causes the router to request the use of Van Jacobson compression which compresses TCP/IP headers to about 3 octets, rather than the standard 40 octets. Use this setting to improve efficiency on slow links.

Request remote (VJ) compression

When enabled, causes the router to send a negotiation packet that requests that the remote device requests VJ compression.

Request local PFC

When enabled, causes the router to request Protocol Field Compression (PFC) which compresses PPP protocol fields from 2 octets to 1 octet.

Remote PFC

When enabled, causes the router to ask the remote device to request Protocol Field Compression.

Request BACP

When enabled, the router will use the Bandwidth Allocation Control Protocol (BACP) to determine the ISDN number to dial for the seconds or third multi-link connection.

Allow remote end to request callback

When enabled, requests a callback when it dials into a remote device. The answering PPP instance of the remote router must also be configured with the telephone number of the calling router and a suitable username, password combination.

Allow remote end to request callback

Controls whether or not the router will respond to incoming callback requests. The options are:

- Off
- Desired
- Required

Allow this unit to authenticate using**CHAP-MD5**

Selecting enabled from the drop-down menu allows the router to authenticate logins using the CHAP MD-5 algorithm.

MS-CHAP

Selecting enabled from the drop-down menu allows the router to authenticate logins using Microsoft's proprietary MS-CHAP algorithm.

MS-CHAPv2

Selecting enabled from the drop-down menu allows the router to authenticate logins using version 2 of Microsoft's proprietary MS-CHAP algorithm.

Allow a remote unit to authenticate using**CHAP-MD5**

When enabled, allows the router to authenticate with a remote unit using the CHAP-MD5 algorithm.

MS-CHAP

When enabled, allows the router to authenticate with a remote unit using Microsoft's MS-CHAP algorithm.

MS-CHAPv2

When enabled, allows the router to authenticate with a remote unit using version 2 of Microsoft's MS-CHAP algorithm.

3. Click **Apply**.

 **Command line**

Command	Instance	Parameter	Values	Equivalent web parameter
ppp	n	maxneg	0-2147483648	Restrict the negotiation time to s seconds
ppp	n	noremaddr	off, on	Disconnect if the remote request an IP address
ppp	n	l_accm	0x00000000-0xFFFFFFFF Default 0x00000000	Desired local ACCM
ppp	n	r_accm	0x00000000-0xFFFFFFFF Default 0xFFFFFFFF	Desired remote ACCM
ppp	n	l_mru	0-n Default 1500	Desired local MRU
ppp	n	r_mru	0-n Default 1500	Desired remote MRU
ppp	n	l_acfc	off, on	Request local ACFC
ppp	n	r_acfc	off, on	Request remote ACFC
ppp	n	l_pap	off, on	Request local PAP authentication
ppp	n	r_pap	off, on	Request remote PAP authentication
ppp	n	l_chap	off, on	Request local CHAP authentication
ppp	n	r_chap	off, on	Request remote CHAP authentication
ppp	n	l_comp	off, on	Request local (VJ) compression
ppp	n	r_comp	off, on	Request remote (VJ) compression
ppp	n	l_pfc	off, on	Request local PFC
ppp	n	r_pfc	off, on	Remote PFC
ppp	n	l_bacp	off, on	Request BACP
ppp	n	l_callb	off, on	Request callback

Command	Instance	Parameter	Values	Equivalent web parameter
ppp	n	r_callb	0-2 0=Off 1=Desired 2=Required	Allow remote end to request callback
ppp	n	l_md5	0-2 0=Disabled 1=Enabled 2=Preferred	Allow this unit to authenticate using CHAP-MD5
ppp	n	r_md5	0, 1 0=Off 1=On	Allow remote unit to authenticate using CHAP-MD5
ppp	n	l_ms1	0, 1 0=Disabled 1=Enabled 2=Preferred	Allow this unit to authenticate using MS-CHAP
ppp	n	r_ms1	0, 1 0=On 1=Off	Allow remote unit to authenticate using MS-CHAP
ppp	n	l_ms2	0-2 0=Disabled 1=Enabled 2=Preferred	Allow this unit to authenticate using MS-CHAPv2
ppp	n	r_ms2	0, 1 0=Off 1=On	Allow remote unit to authenticate using MS-CHAPv2
ppp	n	lcn	0-4096	LCN
ppp	n	lcnup	1=up, 0=down	LCN direction
ppp	n	defpak	16,32,64,128,256,512 or 1024	Default X.25 packet size
ppp	n	cingnua	text (valid NUA)	Use NUA
ppp	n	ipmode	0=XOT, 1=raw TCP	Use TPAD over interface
ppp	n	baklcn	1-4095	(Backup) LCN
ppp	n	baklcnup	1=up, 0=down	(Backup) LCN direction
ppp	n	bakl2iface	lapb, lapd, tcp, ssl, vxn	Use backup interface
ppp	n	bakl2nb	0-255	Use backup interface
ppp	n	bakcingnua		
ppp	n	baknum		
ppp	n	dmnr_reg		

Command	Instance	Parameter	Values	Equivalent web parameter
ppp	n	dmnrtun_add		

PPP QoS parameters

The parameters on this page control the Quality of Service management facility. Each PPP instance has an associated QoS instance, where **PPP 0** maps to **QoS 0**, **PPP 1** maps to **QoS 1**, and so on. These QoS instances include ten QoS queues into which packets may be placed when using QoS. Each of these queues must be assigned a queue profile from the twelve available.

▼ QoS

Enable QoS on this interface

Link speed kbps

Queue	Profile	Priority
0	0 ▼	Very High ▼
1	1 ▼	High ▼
2	2 ▼	Medium ▼
3	3 ▼	Low ▼
4	4 ▼	Very Low ▼
5	4 ▼	Very Low ▼
6	4 ▼	Very Low ▼
7	4 ▼	Very Low ▼
8	4 ▼	Very Low ▼
9	4 ▼	Very Low ▼
10	4 ▼	Very Low ▼
11	4 ▼	Very Low ▼
12	4 ▼	Very Low ▼
13	4 ▼	Very Low ▼
14	4 ▼	Very Low ▼

To configure the PPP QoS parameters, set the following values:

Enable QoS on this interface

When enabled, displays the following QoS configuration parameters:-

- **Link speed n Kbps:** The value in this text entry box should be set to the maximum data rate that this PPP link is capable of sustaining. The router uses this setting when calculating whether the data rate from a queue exceeds its minimum Kbps setting, as determined by the profile assigned to it and send at a higher rate, up to the maximum Kbps setting.
- **Queue n:** Below this column heading, is a list of ten queue instances. Each instance is associated with the profile and priority on the same row.
- **Profile n:** This column contains the profile to be associated with the queue. There are twelve available, **0-11**, selected from the drop-down list boxes.
- **Priority:** Assigns a priority to the selected queue. Available priorities are: **Very High**, **High**, **Medium**, **Low**, and **Very Low**.

Related CLI commands

Entity	Instance	Parameter	Values	Equivalent web parameter
qos	n	linkkbps	0-	Link speed n kbps
qos	n	q0prof	0-11	Queue 0 Profile
qos	n	q0prio	0-4 0=Very high 1=High 2=Medium 3=Low 4=Very Low	Queue 0 Priority
qos	n	q1prof	0-11	Queue 1 Profile
qos	n	q1prio	0-4	Queue 1 Priority
qos	n	q2prof	0-11	Queue 2 Profile
qos	n	q2prio	0-4	Queue 2 Priority
qos	n	q3prof	0-11	Queue 3 Profile
qos	n	q3prio	0-4	Queue 3 Priority
qos	n	q4prof	0-11	Queue 4 Profile
qos	n	q4prio	0-4	Queue 4 Priority
qos	n	q5prof	0-11	Queue 5 Profile
qos	n	q5prio	0-4	Queue 5 Priority
qos	n	q6prof	0-11	Queue 6 Profile
qos	n	q6prio	0-4	Queue 6 Priority
qos	n	q7prof	0-11	Queue 7 Profile
qos	n	q7prio	0-4	Queue 7 Priority
qos	n	q8prof	0-11	Queue 8 Profile
qos	n	q8prio	0-4	Queue 8 Priority
qos	n	q9prof	0-11	Queue 9 Profile
qos	n	q9prio	0-4	Queue 9 Priority

Configure PPP sub-configurations

Using PPP sub-configurations is an alternative to using an entire PPP instance, if only a few parameters are different to those in an existing PPP instance. Using PPP sub-configurations, you can define up to **50** sub-configurations and save them in system memory.

Web

1. Go to **Configuration > Network > Interfaces > Advanced > PPP Sub-Configs**.
2. Set the following parameters:

▼ PPP Sub-Configs

You may specify up to 50 PPP sub-configs

Nb	Description	Username	Password	Dialout Number
No PPP Sub-Cfg configurations have been added				
1 ▼	<input type="text"/>	<input type="text"/>	<input type="text"/> Confirm	<input type="text"/>
<input type="button" value="Add"/>				

Nb

The instance number for a sub-config.

Description

The name to easily identify the sub-config.

Username

The username for authenticating with the remote system. Usually required for outgoing PPP calls only.

Password

The password for authentication with the remote system.

Confirm

When changing the password, enter it into this text box also to allow the router to check for simple typing errors.

Dialout Number

The ISDN number to make outgoing calls. This must be a valid number in order to allow the router to make outgoing calls. This number could be the number of the Internet Service Provider (ISP) or another router.

Add button

Adds the PPP sub-config to the PPP configuration.

3. Click **Apply**.

**Command line**

Command	Instance	Parameter	Values	Equivalent web parameter
pppcfg	1-50	name	Up to 25 characters	Description
pppcfg	1-50	username	Valid username up to 60 characters	Username
pppcfg	1-50	password	Valid password up to 40 characters	Password
pppcfg	1-50	phonenum	Up to 25 digits	Dialout Number

Configure PPP over Ethernet

PPP over Ethernet (PPPoE) is a means of establishing a PPP connection over the top of an Ethernet connection. The implementation provided is compliant with *RFC 2516, "A Method for Transmitting PPP Over Ethernet"*. A typical application would be to allow non-PPPoE enabled devices to access Internet services where the connection to the Internet is provided by an ADSL bridge device.

Web

There is no dedicated web page for configuring the router to use PPPoE. Instead, there are several parameters on other web pages you must use together to establish a PPPoE connection over the appropriate Ethernet interface. In particular, the following configuration pages and parameters are important.

1. Go to the **Configuration > Network > Interfaces > Advanced > PPP n-n > PPP n** pages for the PPP connections that require PPPoE.
2. Set the following parameters:
 - As a minimum requirement, set the **Username** and **Password** parameters.
 - The setting **This PPP interface will use x,y** defines the physical Ethernet interface over which the PPPoE session will operate. In most cases, this physical interface is **PPPoE 0** (for Ethernet **0**). The fact that you have selected **PPPoE 0** as the physical interface for operation with PPP automatically enables PPPoE mode. If the router uses another Ethernet instance, for example, **Eth 1**, you must select **PPPoE 1** to ensure the router uses the correct MAC address. This parameter value is in the format **0** or blank for port **0**, **1** for port **1**, **2** for port **2** etc.
 - If necessary, go to the page **Configuration > Network > Interfaces > Advanced > PPP n-n > PPP n > Advanced** and set the **Enable "Always On" mode of this interface** parameter to **On** to configure the router so that it will attempt to renegotiate the PPP link should it go down for any reason.
 - **PPP negotiation**: Initialize the advanced PPP options on this page as required by your ISP.
 - **Desired Local MRU** and **Desired Remote MRU**: Set to **1492**.
 - **Request Local ACFC** and **Request Remote ACFC**: Set to **No**.
 - **Request Local PFC** and **Request Remote PFC**: Set to **No**.
 - **Desired Local ACCM** and **Desired Remote ACCM**: Set to **0xffffffff**.
3. Click **Apply** on each PPP settings page when done.

Command line

There are no specific PPPoE commands available to the user via the text command interface. Use the appropriate **ppp** commands to set the required options.

Configuring DHCP servers

About DHCP servers	400
Configure DHCP server for Ethernet interfaces	401
Configure advanced DHCP parameters	404
Configure advanced DHCP options	405
Configure DHCP options	407
Configure static lease reservations	409

About DHCP servers

Digi routers incorporate one or more Dynamic Host Configuration Protocol (DHCP) servers, one for each Ethernet port. DHCP is a standard Internet protocol that allows a DHCP server to dynamically distribute IP addressing and configuration information to network clients.

Web

Go to **Configuration > Network > DHCP server**. These pages include a web page for configuring each of the DHCP servers. Additionally, there is a separate page for mapping MAC addresses to fixed IP addresses.

Configure DHCP server for Ethernet interfaces

Web

1. Go to **Configuration > Network > DHCP Server > DHCP Server for Ethernet n.**

DHCP Server
 DHCP Server for Ethernet 0

Enable DHCP Server

IP Addresses: to
 to
 to

Mask:

Gateway:

DNS Server:

Secondary DNS Server:

Domain Name:

Lease Duration: days hrs mins

Wait for milliseconds before sending DHCP offer reply

Duplicate Address Detection

Only send offers to Wi-Fi clients

DHCP Relay
 Forward DHCP requests to:

2. Configure DHCP server parameters:

Enable DHCP Server

When enabled, displays the following parameters:

IP Addresses a.b.c.d to a.b.c.d

There are six text boxes in this part of the page; three rows of two. The values in these specify the starting and ending addresses for the range of IP addresses that will be handed out by the DHCP server. You can use each of the three rows to specify a different IP address pool; all pools should be within the same subnet. When the minimum IP address text box is clear, the DHCP service will be disabled. In other words, in order to enable the DHCP service, there must be at least one minimum IP address and a range.

Using the CLI, this is specified slightly differently, a starting address and a range are specified instead.

Mask

The subnet mask on the network to which the router is connected.

Gateway

A gateway is required in order to route data to IP addresses that are not on the local subnet. The value in this text box specifies the IP address of the gateway (which is usually the IP address of the router itself as configured by the IP address of the Ethernet interface associated with this DHCP instance). Alternatively, this may be set to the IP address of another router on the LAN.

DNS Server

The IP address of the primary DNS server to use by clients on the LAN. This is usually the IP address of the route itself. Alternatively, this may be set to the IP address of an alternative DNS server on the LAN.

Secondary DNS Server

The IP address of a secondary DNS server (if available) that DHCP clients on the LAN use.

Domain Name

The domain name returned to clients.

Lease Duration *d days h hrs m mins*

How long a DHCP client can use the assigned IP address before it must renew its configuration with the DHCP server. When configuring this value using the command line interface be aware that this parameter is specified in minutes. The three boxes here are for convenience when using long lease durations.

Wait for *s milliseconds* before sending DHCP offer reply

When this setting is enabled, the router uses the value in the text box as the delay to use prior to sending out the **DHCP_OFFER** message. Enabling this functionality and setting the delay to a non-zero value will allow other DHCP servers on the network to respond first.

Duplicate Address Detection

If enabled, causes the router to detect duplicate addresses.

Only send offers to Wi-Fi clients

When enabled, causes the router to only send DHCP offers to Wi-Fi clients. This is useful if the router serves as an access point and there is a separate DHCP server on the Ethernet LAN.

DHCP Relay**Forward DHCP requests to *a.b.c.d***

The values in these two text boxes specify the IP addresses of the two supported DHCP relay agents. If the DHCP server is on a different subnet, specifying the IP address of the server in this text box will cause the router to forward DHCP requests to the IP address specified. The DHCP server must be within **4** hops.

3. Click **Apply**.

Command line

Command	Instance	Parameter	Values	Equivalent web parameter
dhcp	n	IPmin	Valid IP address a.b.c.d	IP Addresses a.b.c.d
dhcp	n	IPrange	0-2147483647 Default 20	to a.b.c.d
dhcp	n	IPmin2	Valid IP address a.b.c.d	IP Addresses a.b.c.d
dhcp	n	IPrange2	0-2147483647 Default 0	to a.b.c.d
dhcp	n	IPmin3	Valid IP address a.b.c.d	IP Addresses a.b.c.d
dhcp	n	IPrange3	0-2147483647 Default 0	to a.b.c.d
dhcp	n	mask	Valid IP address a.b.c.d	Mask
dhcp	n	gateway	Valid IP address a.b.c.d	Gateway
dhcp	n	DNS	Valid IP address a.b.c.d	DNS Server
dhcp	n	DNS2	Valid IP address a.b.c.d	Secondary DNS Server
dhcp	n	domain	Up to 64 characters	Domain Name
dhcp	n	lease	0-2147483648 minutes Default 20160 minutes (14 days)	Lease Duration d days, h hrs, m mins
dhcp	n	respdelms	0-2147483647	Wait for s milliseconds before sending DHCP offer reply
dhcp	n	wifionly	off, on	Only send offers to Wi-Fi clients
dhcp	n	fwddip	Valid IP address a.b.c.d	Forward DHCP requests to a.b.c.d
dhcp	n	fwddip2	Valid IP address a.b.c.d	Forward DHCP requests to a.b.c.d

Configure advanced DHCP parameters

Web

1. Go to **Configuration > Network > DHCP Server > DHCP Server for Ethernet n > Advanced**.
2. Set advanced DHCP parameters:

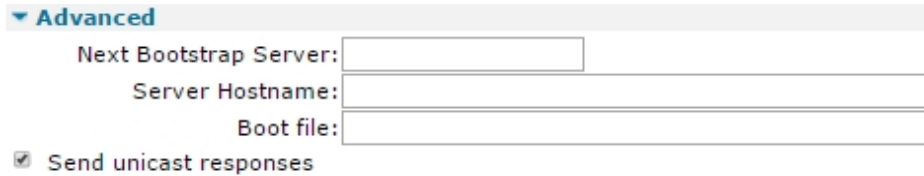

Advanced
 Next Bootstrap Server:
 Server Hostname:
 Boot file:
 Send unicast responses

Next Bootstrap Server a.b.c.d

The IP address of a secondary configuration server. This server does not have to be on the same logical subnet as the client.

Server Hostname

The name of a host that the DHCP client can make contact with in order to download a boot file.

Boot file

The name of the boot file the client can download from the host specified in the **Server Hostname** text box.

Send unicast responses

If enabled, sends unicast responses to DHCP clients from the DHCP server.

3. Click **Apply**.

Command line

Command	Instance	Parameter	Values	Equivalent web parameter
dhcp	n	nxtsvr	Valid IP address a.b.c.d	Next Bootstrap Server
dhcp	n	sname	Up to 64 characters	Server Hostname
dhcp	n	file	Up to 64 characters	Boot file

Configure advanced DHCP options

Web

1. Go to **Configuration > Network > DHCP Server > DHCP Server for Ethernet n > Advanced DHCP Options**.

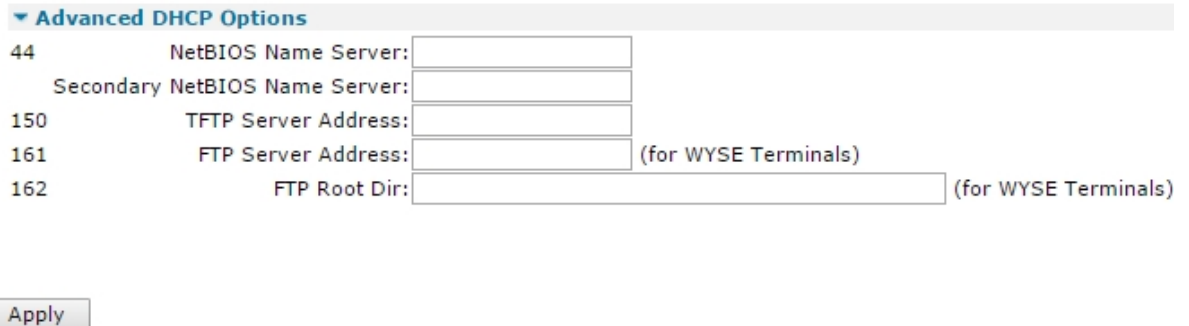

Advanced DHCP Options	
44	NetBIOS Name Server: <input type="text"/>
	Secondary NetBIOS Name Server: <input type="text"/>
150	TFTP Server Address: <input type="text"/>
161	FTP Server Address: <input type="text"/> (for WYSE Terminals)
162	FTP Root Dir: <input type="text"/> (for WYSE Terminals)

2. Set advanced DHCP options:

NetBIOS Name Server a.b.c.d

The IP address of the primary WINS server address.

Secondary NetBIOS Name Server a.b.c.d

The IP address of the secondary WINS server address.

TFTP Server Address a.b.c.d

The IP address of a TFTP server. Boot images mainly use this address.

FTP Server Address a.b.c.d (for WYSE Terminals)

The IP address of an FTP server and is a custom option for use with WYSE terminals.

FTP Root Dir (for WYSE Terminals)

The root directory for FTP transfers. This is also a custom option for use with WYSE terminals.

3. Click **Apply**.

Command line

Command	Instance	Parameter	Values	Equivalent web parameter
dhcp	n	NBNS	Valid IP address a.b.c.d	NetBIOS Name Server a.b.c.d
dhcp	n	NBNS2	Valid IP address a.b.c.d	Secondary NetBIOS Name Server a.b.c.d

Command	Instance	Parameter	Values	Equivalent web parameter
dhcp	n	tftp	Valid IP address a.b.c.d	TFTP Server Address a.b.c.d
dhcp	n	ftp	Valid IP address a.b.c.d	FTP Server Address a.b.c.d
dhcp	n	ftproot	Up to 64 characters	FTP Root Dir

Configure DHCP options

Web

1. Go to **Configuration > Network > DHCP Server > DHCP Options**.

The **DHCP Options** pages allow custom (or non-standard) DHCP options to be configured and sent to the DHCP client when requesting an IP address and other DHCP parameters. This is useful for devices such as IP telephones that use specific strings. On the web page, these (up to ten) options are configured using a table.

▼ DHCP Options

You can specify up to 10 DHCP options

DHCP Options		
Option	Data type	Value
No DHCP Options configured		
<input type="text"/>	<input type="text" value="▼"/>	<input type="text"/> <input type="button" value="Add"/>

2. Enter DHCP options in the table:

Option

The DHCP option number.

Data type

The data type for the option and can be any one of the following; **1**, **2**, or **4** byte value, IPv4 address, text string, or hexadecimal data.

Value

The actual data that will be sent in the DHCP option message.

3. Click **Apply**.

Command line

Command	Instance	Parameter	Values	Equivalent web parameter
dhcpcpt	n	optnb	0-2147483647 Default 0	Option

Command	Instance	Parameter	Values	Equivalent web parameter
dhcpt	n	type	i1=1 byte value i2=2 byte value i4=4 byte value ipv4=IPv4 address string=string hex=hexadecimal	Data type
dhcpt	n	value	Up to 127 octets	Value

For example, to set the option number to **9** for the LPR Server, the command is:

```
dhcpt 0 optnb 9
```

Configure static lease reservations

The Static Lease Reservations settings control the configuration of MAC address to IP address mappings. These settings assign a specific IP address to a particular Ethernet MAC address. They are particularly useful for mobile applications, such as W-WAN where a particular item of mobile equipment should be issued with the same IP address regardless of when it was last connected to the network. Up to ten MAC to IP address reservations may be specified.

Web

1. Go to **Configuration > Network > DHCP Server > Static Lease Reservations**.

▼ Static Lease Reservations

A reservation IP address must not be the same as the IP address of the DHCP server itself. It must be a valid IP address in the subnetwork of the DHCP server. The DHCP server will ignore a reservation that does not meet these requirements. A valid **MAC** address has the format 11:22:33:44:55:66 (a hyphen '-' is also accepted as the separator).

(you may specify up to 128 reservations)

Static Lease Reservations	
IP Address	MAC Address
No lease reservations have been configured	
<input type="text"/>	<input type="text"/>
<input type="button" value="Add"/>	

Note Any IP addresses specified on this page must not be in the range of IP address specified in the **DHCP Server** page.

2. Enter static lease reservation parameters:

IP Address *a.b.c.d*

The IP address to be assigned.

MAC Address *aa.bb.cc.dd.ee.ff*

The MAC address which is to be given the above IP address.

Add button

Adds the specified static lease reservation to the DHCP configuration.

Delete button

Removes an existing static lease reservation from the DHCP configuration.

3. Click **Apply**.

 **Command line**

Command	Instance	Parameter	Values	Equivalent web parameter
mac2ip	n	IPAddr	Valid IP address a.b.c.d	IP Address a.b.c.d
mac2ip	n	mac	Valid MAC address aa.bb.cc.dd.ee.ff	MAC Address aa.bb.cc.dd.ee.ff

Two commands are required to set up a mapping:

```
mac2ip <instance> mac <MAC address>
mac2ip <instance> IPAddr <IP address>
```

where **<instance>** can be **0-9**.

Configuring network services

Configure network services	412
----------------------------------	-----

Configure network services

The Network Services Settings page configures a set of common network services that are available for the router, and the network port on which the service is running. You can enable and disable common network services and configure the TCP/UDP port on which the network service listens. You can disable services as needed for security purposes. That is, you can disable certain services so the device runs only those services specifically needed. To improve device security, you can disable non-secure services such as Telnet.

Web

1. Go to **Configuration > Network > Network Services**.

On the **Network Services** page, you can quickly enable or disable network services without having to navigate to multiple sections of the menu. Some network services have additional configuration settings.

Configuration - Network > Network Services

Network Services

- Enable Device Discovery (ADDP)
 - Password:
 - Confirm password:
- Enable Realport TCP Port:
- Enable Encrypted Realport TCP Port:
- Enable Network Management Protocol (SNMP) UDP Port:
 - Enable SNMP v1
 - Enable SNMP v2c
 - Enable SNMP v3
- Enable Simple Network Time Server (SNTP) Source:
- Enable Secure Shell Server (SSH / SFTP)
- Enable FTP Server
- Enable HTTP Server
- Enable HTTPS Server
- Enable Telnet Server
- Enable Telnet over SSL Server
- Enable ASY Port Server
- Enable ZING
- Enable RCI over HTTP

ASY 0 Listening Port:	<input type="text" value="4000"/>
ASY 1 Listening Port:	<input type="text" value="4001"/>
ASY 2 Listening Port:	<input type="text" value="4002"/>
ASY 3 Listening Port:	<input type="text" value="4003"/>
ASY 4 Listening Port:	<input type="text" value="4004"/>
ASY 5 Listening Port:	<input type="text" value="4005"/>
ASY 6 Listening Port:	<input type="text" value="4006"/>
ASY 7 Listening Port:	<input type="text" value="4007"/>
ASY 8 Listening Port:	<input type="text" value="4008"/>
ASY 9 Listening Port:	<input type="text" value="4009"/>

2. Enable or disable network services as needed:

Enable Device Discovery Protocol (ADDP)

When enabled, the router uses Advanced Digi Discovery Protocol (ADDP), a Digi-proprietary protocol for discovering devices on a network.

Enable Realport

When enabled, the router uses RealPort, patented RealPort COM/TTY port redirection software for Microsoft Windows.

Enable Encrypted Realport

When enabled, the router uses RealPort software with encryption. Encrypted RealPort offers a secure Ethernet connection between the COM or TTY port and a device server or terminal server. Encryption prevents internal and external snooping of data across the network by encapsulating the TCP/IP packets in a Secure Sockets Layer (SSL) connection and encrypting the data using Advanced Encryption Standard (AES).

Enable Network Management Protocol (SNMP)

Enables and disables remote management of the router using SNMP. This setting does not actually directly control the SNMP functionality, but enables or disables the remaining SNMP controls on this page. To perform detailed configuration, including setting up command filters, users and SNMP traps, go to **Configuration > Remote Management > SNMP**.

Note Simply clicking on this setting may not be sufficient to allow this service to start working. Depending upon the SNMP version selected below, additional configuration may be required.

UDP Port n

The standard UDP port for SNMP is **161**, the default. If you require a different port, enter the port number into the text entry box.

Enable SNMP v1

When enabled, the router uses SNMP version 1.

Enable SNMP v2c

When enabled, the router uses SNMP version 2c.

Enable SNMP v3

When enabled, the router uses SNMP version 3.

Enable Simple Network Timer Server (SNTP)

When enabled, the router acts as a Simple Network Time Protocol (SNTP) time server.

Source

This drop-down selection menu selects the source that supplies time data for the SNTP server. The usual options are:

- Internal real time clock (RTC) device
- A GPS module (if supported)
- An NTP client (if supported)

Enable Secure Shell Server (SSH / SFTP)

When enabled, the router uses Secure Shell Server (SSH) and Secure File Transfer Protocol (SFTP) for entering commands and transferring files. The simplest way to check the status or configuration of the router or to upload new firmware is to use the command-line interface over a directly connected ASY port or via a telnet session. Both of these options have security implications. If you want to gain access to the command line interface of the router but using a more secure protocol, enabling this setting enables a secure shell to start. This option also enables support for SFTP for secure file transfers.

Enable FTP Server

When enabled, the router uses File Transfer Protocol (FTP) for file transfers.

Enable HTTP Server

When enabled, the router uses HTTP, or insecure web server. You can perform most router configuration using the HTTP web server as described here. However, HTTP is an insecure protocol. For security reasons, you can disable this service by deselecting this radio button, which enables the following secure web server (HTTPS). If security is not as much of an issue, selecting this option allows using the simpler and slightly more convenient web server.

Enable HTTPS Server ()

When enabled, the router uses HTTPS, or secure web server. Selecting this option also disables the insecure HTTP protocol.

Enable Telnet Server

Selects between a simple Telnet server or a Telnet over SSL server. When this option is selected, the simple, insecure version of telnet is enabled.

Enable Telnet over SSL Server

When enabled, enables telnet over the Secure Sockets Layer (SSL) protocol. Select this option if security is an issue. Selecting this option disables the simple version in addition to enabling telnet over SSL.

Enable ASY Port Server

When enabled, the router uses the asynchronous (ASY) port server.

Enable ZING

When enabled, the router uses the ZING protocol. ZING is a Digi-proprietary protocol for configuring devices that do not have an IP address. ZING is no longer used.

Enable RCI over HTTP

When enabled, the router supports sending/receiving of Remote Command Interface (RCI) requests over HTTP, through the embedded web server. The web server provides the initialization, receiving, sending, and security for requests.

ASY O-n Listening Port

For the specified ASY port, sets the network port number on which to listen.

3. Click **Apply**.

Command line

Command	Instance	Parameter	Values	Equivalent web parameter
addp	0	enable	on, off	Enable Device Discovery (ADDP)
rport	0	enabled	on, off	Enable RealPort
rport	0	encryption	on, off	Enable Encrypted RealPort
snmp	n	v1enable	0, 1 0=Off 1=On	Enable Network Management Protocol > Enable SNMP v1
snmp	n	port	Default 161	Enable Network Management Protocol > UDP Port n
snmp	n	v2cenable	0, 1 0=Off 1=On	Enable Network Management Protocol > SNMP v2c
snmp	n	v3enable	0, 1 0=Off 1=On	Enable Network Management Protocol > Enable SNMP v3
sntp	0	svr_mode	on, off	Enable Simple Network Time Server (SNTP)
sntp	0	time_src	0=RTC 1=GPS 2=NTP Client	Enable Simple Network Time Server (SNTP) > Source
services	0	SSH	on, off	Enable Secure Shell Server (SSH/SFTP)
services	0	ftp	on, off	Enable FTP Server
services	0	http	on, off	Enable HTTP Server
services	0	telnet	on, off	Enable Telnet Server
services	0	telnets	on, off	Enable Telnet over SSL Server
services	0	asytcp	on, off	Enable ASY Port Server
tcpperm	ASY 0-9	-l<listening port>	<listening port>	ASY 0-9 Listening Port
services	0	zing	on, off	Enable ZING
cmd	0	rcihttp	on, off	Enable RCI over HTTP

Configuring DNS

Configure DNS servers	418
DNS Server Update parameters	419
Configure Dynamic DNS (DynDNS)	423

Configure DNS servers

The Domain Name Server (DNS) selection parameters configure a DNS server based on the DNS query. For example, you can direct DNS lookups for internal servers to an internal DNS server and send all other DNS requests directly to an external DNS server managed by your Internet service provider.

DNS Server n parameters

Web

1. Go to **Configuration > Network > DNS Servers > DNS Server n**.

DNS Servers

This allows you to configure the router to direct DNS queries to specific DNS servers based on the name being queried.

▼ DNS Server 0

For DNS requests matching , send the request to

DNS Server:

Secondary DNS Server:

Route using Routing table

Interface

Use source IP Address of sending interface

Interface

2. Configure DNS server parameters:

For DNS requests matching pattern, send the request to

The hostname pattern to match for the specified DNS server. This parameter needs a wildcard to prefix the domain name. For example, to match DNS queries for all **digi.com** servers, enter ***.digi.com**. When using this feature, set the last DNS server selection hostname pattern to ***** to match all other DNS lookups. This ensures all the DNS lookup configuration is kept together for ease of troubleshooting. Otherwise, the lookups will use the DNS server configured on the interface of the default route.

DNS Server a.b.c.d

The IP address of the DNS server to use when a DNS request matches the hostname pattern.

Secondary DNS Server a.b.c.d

In the event of the primary DNS server not being available, the IP address in this text box specifies the destination for DNS queries matching the hostname pattern.

Route using Routing table / Interface x,y

Control whether the router should look up the route to the DNS server by using the routing table or should send the DNS query out of a specific interface. Selecting the **Interface** radio button enables the drop-down box and interface instance text box. Available options for the interface are **PPP** and **Ethernet**. Fill in the adjacent text box with the number of a valid instance of the interface, such as **Ethernet 3**. (Different router models support different numbers of interfaces).

Use source IP Address of Sending interface / Interface x,y

Control whether the DNS query should go out having the source address of the sending interface or a different interface. This will be required for routing if the route to the DNS server is via an IPsec tunnel, to ensure the local and remote subnet selectors match.

3. Click **Apply**.

Command line

Command	Instance	Parameter	Values	Equivalent web parameter
dnssel	n	pattern	*.domain.com	For DNS requests matching pattern, send the request to
dnssel	n	svr	Valid IP address	DNS Server a.b.c.d
dnssel	n	secsvr	Valid IP address	Secondary DNS Server a.b.c.d
dnssel	n	ent	PPP, Ethernet	Interface x,y
dnssel	n	add	Valid interface number	Interface x,y
dnssel	n	ipent	PPP, Ethernet	Interface x,y
dnssel	n	ipadd	Valid interface number	Interface x,y

DNS Server Update parameters

Dynamic DNS is supported in accordance with RFC2136 and RFC2485. This allows routers to update specified DNS servers with their IP addresses when they first connect to the Internet and at regular intervals thereafter. The parameters in this section control how the router updates a specified DNS server with its IP address when it first connects to the Internet and at regular intervals thereafter.

The parameters set here are not to be confused with the popular dynamic DNS service **dyndns.com**; there is a separate page for configuring the router to work with **dyndns.com**. See [Configure Dynamic DNS \(DynDNS\)](#).

Web

Go to **Configuration > Network > DNS Servers > DNS Server Update**.

▼ DNS Server Update

This allows you to configure the router to update a specified DNS server with its IP address when it first connects to the Internet and at regular intervals thereafter.

Send an update to DNS Server for
 Name:
 Zone:
 when the default route changes
 interface becomes active
 Also send an update every hrs mins secs
 The DNS server should delete all previous records
 DNS Server Username:
 DNS Server Password: Password is Base64 encoded
 Confirm DNS Server Password:
 Local time offset from GMT auto detect

 Required Time Accuracy seconds
 Allow DNS clients to cache this entry for seconds

Apply

Send an update to DNS Server a.b.c.d for

The IP address in this text box specifies the DNS server that should be sent the updated information. The server must support **DNS Update messages**. Dynamic DNS is generally offered as a subscription-based service by ISPs, but for a large number of deployed routers, it may be more appropriate to set up a dedicated DNS server locally.

Name

The member of the DNS zone to update. Along with the zone parameter, uniquely identifies the router. For example, if the router has a name of **epos33**, the full address of the router is **epos33.mycompany.com**.

Zone

The DNS zone to update. When using Dynamic DNS, you must have a domain name. This domain name can be purchased from an appropriate vendor. Enter this domain name, such as **mycompany.com**, in the **Zone** field.

When the default route changes

Interface x,y becomes active

These settings determine when the update is sent, such as when the default route changes or when the specified interface becomes active. The drop-down list offers the options of PPP or Ethernet. In the text box, enter the instance number for the specified interface.

Also send an update every h hrs, m mins, s secs

The interval at which the router issues update messages to the DNS server.

The DNS server should delete all previous records

When enabled, causes the DNS server to delete all records of previous addresses served to the router.

DNS Server Username

The username allocated by the Dynamic DNS service provider.

DNS Server Password

The password allocated by the Dynamic DNS service provider.

Password is Base64 encoded

Some Dynamic DNS servers issue passwords that are Base64 encoded, such as Linux Base servers. If this is the case, check this check box to switch on the Base64 decoding of the password before transmission. The password is not actually transmitted as part of the message; it appears in a signature appended to the message. If the password is issued as a hexadecimal string and not straight text, you must use the prefix **0x** in the password text box.

Confirm DNS Server Password

Enter the password in this text box to confirm it.

Local time offset from GMT**Auto detect**

These two radio buttons control whether the offset of the local time from GMT should be auto-detected or specified. This feature is required since a GMT timestamp must be included as part of the authentication message. When set to **Auto detect**, the router automatically applies the correction. When **Auto detect** is not selected, select the correct offset from the drop-down list.

Required Time Accuracy

The permitted variance between the router's time and that of the DNS server. If the time difference exceeds this limit, the DNS update will fail.

Allow DNS clients to cache this entry for s seconds

How long a router that resolved the address is allowed to cache that address.

 **Command line**

Command	Instance	Parameter	Values	Equivalent web parameter
dnsupd	0	server	Valid IP address a.b.c.d	Send an update to DNS Server a.b.c.d
dnsupd	0	name	up to 20 characters	Name
dnsupd	0	zone	up to 64 characters	Zone
dnsupd	0	ifent	PPP,ETH	when interface x,y becomes active

Command	Instance	Parameter	Values	Equivalent web parameter
dnssupd	0	ifadd	Valid instance number	when interface x,y becomes active
dnssupd	0	upd_int	0 – 2147483648 (seconds)	Also send an update every h hrs, m mins s secs
dnssupd	0	delprevrr	off, on	The DNS server should delete all previous records
dnssupd	0	username	Valid username (up to 20 characters)	DNS Server Username
dnssupd	0	password	Valid password (up to 100 characters)	DNS Server Password
dnssupd	0	b64pwd	off, on	Password is Base64 encoded
dnssupd	0	autozone	off, on	Local time offset from GMT auto detect
dnssupd	0	tzone	-2147483648 -2147483647 (hours)	Local time offset from GMT n
dnssupd	0	fudge	0 – 2157483648 (seconds)	Required Time Accuracy s seconds
dnssupd	0	tll	0 – 2157483648 (seconds)	Allow DNS clients to cache this entry for s seconds

Configure Dynamic DNS (DynDNS)

The Dynamic DNS client (DynDNS) updates DNS hostnames with the current IP address of a particular interface. Dynamic DNS operates under the specification supplied by **DynDNS** (go to <http://dyn.com>), referred to in the web interface as **Dynamic DNS**.

When an interface connects, the client checks the current IP address of that interface. If the IP address differs from that obtained from the previous connection, the Dynamic DNS service is contacted, and the hostnames specified in the **Hostname** parameters are updated with the new address.

Dynamic DNS parameters

Web

1. Go to **Configuration > Network > Dynamic DNS**.

Dynamic DNS

A Dynamic DNS (DDNS) service allows a user whose IP address is dynamically assigned to be located by a host or domain name. Before a DDNS server may be used, you must create an account with the DDNS service provider. The provider will give you account information such as username and password. You will use this account information to register your IP address and update it as it changes.

DynDNS.org Service Settings

Note: You must create your account at DynDNS.org or no-ip.com or other provider before you can successfully register the IP address of your router with their service.

This DDNS service supports registration of both public and private IP addresses. However, if you register a private IP address (such as 192.168.x.x or 10.x.x.x), your router may be accessible (by resolving the associated hostname) only from other hosts with access to that private IP subnetwork.

Service Provider: Dynamic DNS
 No-IP
 Other

Service Provider Hostname:

Host and Domain Name(s):

Example: myhost.dyndns.net

Destination port #:

DynDNS User Name:

DynDNS Password:

Confirm DynDNS Password:

DynDNS DDNS System:

When default route
 interface
 becomes active, send DDNS update

Use Wildcards:

2. Configure Dynamic DNS parameters:

Service Provider

Selects the Dynamic DNS service provider. Dynamic TransPort routers support the Dynamic DNS services **Dynamic DNS** (at **dyn.com**) **No-IP** (at **noip.com**). TransPort routers may be compatible with other Dynamic DNS services, which can be selected by setting the **Service Provider** setting to **Other**. For more information about Dynamic DNS services, including other service providers, see this article: https://en.wikipedia.org/wiki/Dynamic_DNS.

Service Provider Hostname

The hostname for the Dynamic DNS service provider.

Host and Domain Name(s)

Up to five host/domain names that are to be updated using the service.

Destination port #

The IP port to use as the destination port. The default value is 0 which causes the router to use the default port number which is port **80**.

DynDNS User Name

The username to use when updating the hostnames. This will have been supplied by the service provider.

DynDNS Password

The password to use when updating the hostnames. This will have been supplied by the service provider.

Confirm DynDNS Password

Enter the password into this text box to confirm it.

DynDNS DDNS System

The value selected from this drop-down list the dynamic DNS system containing the hostnames to be updated. The available options are:

- Dynamic DNS
- Static DNS
- Custom DNS

When default route/interface x,y becomes active, send DDNS update

The radio buttons select whether or not the router should use the default interface or the interface specified from the drop-down list. If the specified interface option is selected, the required interface is selected from the drop-down list and the interface instance is entered into the adjacent text box. If the default interface is selected, the client will keep track of and use the current default route.

Use Wildcards

Selects whether or not wildcard matching on the hostname will be performed. The options are:

- **Disable wildcards**
- **Enable wildcards**
- **No change to service settings**

When enabled, the Dynamic DNS service will match DNS requests of the form ***.hostname** where ***** matches any text. For example, if Hostname1 was set to **site.dyndns.com** and wildcard matching was enabled, then **www.site.dyndns.com** would resolve to the interface address.

3. Click **Apply**.

 **Command line**

Command	Instance	Parameter	Values	Equivalent web parameter
dyndns	0	provider		Service Provider
dyndns	0	provider_hostname		Service Provider Hostname
dyndns	0	hostname1	Up to 40 characters	Host and Domain Name (s)
dyndns	0	hostname2	Up to 40 characters	Host and Domain Name (s)
dyndns	0	hostname3	Up to 40 characters	Host and Domain Name (s)
dyndns	0	hostname4	Up to 40 characters	Host and Domain Name (s)
dyndns	0	hostname5	Up to 40 characters	Host and Domain Name (s)
dyndns	0	port	0 - 65535	Destination port #
dyndns	0	username	Up to 20 characters	DynDNS User Name
dyndns	0	password	Up to 25 characters	DynDNS Password

Command	Instance	Parameter	Values	Equivalent web parameter
dyndns	0	system	Blank, statdns, custom	DynDNS DDNS System
dyndns	0	ifent	Blank,ETH,PPP	When default route/interface x,y becomes active, send DDNS update
dyndns	0	ifadd	0 -2147483647	When default route/interface x,y becomes active, send DDNS update
dyndns	0	wildcard	0, 1, 2 0=Disable wildcards 1=Enable wildcards 2=No change to service settings	Use Wildcards

Advanced Dynamic DNS parameters

Typically, the Advanced Dynamic DNS parameters do not require changing from their defaults.

Note Before configuring dynamic DNS or any of these parameters, it is recommended that you view the information and resources available at the website <http://dyn.com>.

Web

Go to **Configuration > Network > Dynamic DNS> Advanced**.

▼ Advanced

Update interval: days

- Supply the IP address in the update
- Only send update when this router is the VRRP master
- Enable debug

Update interval d days

The number of days between dynamic DNS updates.

Supply the IP address in the update

When enabled (the default), causes the router to supply the IP address as part of the dynamic DNS update. When unchecked, the IP address is not supplied and the DYNDNS server attempts to determine the correct IP address by other means (IP source address in update packet). Use this mode if the router is behind a NAT router only.

Only send update when this router is the VRRP master

When enabled, causes the router to not send DDNS updates unless at least one Ethernet interface is a VRRP master.

Enable debug

When enabled, enables debug tracing of the dynamic DNS transactions.

 **Command line**

Command	Instance	Parameter	Values	Equivalent web parameter
dyndns	0	updateint	0 -255	Update interval d days
dyndns	0	noip	off, on	Supply the IP address in the update
dyndns	0	ifvrrpmaster	off, on	Only send update when this router is the VRRP master
dyndns	0	debug	off, on	Enable debug

Configuring IP routing and forwarding

Supported routes	429
View the TransPort routing table	431
Configure route metrics	432
Configure IP routing parameters	433
Configure static routes	436
Configure default IP routes	444
Configure Routing Information Protocol (RIP) settings	450
Configure Open Shortest Path First (OSPF) parameters	456
Configure Border Gateway Protocol (BGP) settings	459
Configure IP port forwarding and static NAT mappings	461
Configure multicast routes	463
Configure Virtual Routing and Forwarding (VRF)	465

Supported routes

TransPort routers support three main types of routes:

- Dynamic routes
- Static routes
- Default routes

Dynamic routes

Dynamic routes are created automatically when an interface is configured or connected.

For example configuring an **Ethernet 0** interface with an IP address of **192.168.1.1** and mask of **255.255.255.0** will cause a dynamic route to be created automatically.

Thus any packet with destination IP address in the range **192.168.1.0** to **192.168.1.255** will automatically be routed through to the **Ethernet 0** interface.

Static routes

Web

To add static routes, configure a route in **Configuration > Network > IP Routing/Forwarding > Static Routes > Routes 0 – 9 > Route n**, where **n** is an instance number.

The minimum configuration settings required to add a static route are:

- IP Address
- Mask
- Interface
- Interface number

If a static route is pointing at an Ethernet interface, you can optionally add a gateway IP address. If you do not add a gateway IP address, the router automatically uses gateway IP address configured for the Ethernet interface itself.

Default routes

Web

To add default routes, configure a route in **Configuration > Network > IP Routing/Forwarding > Static Routes > Default Route n**, where **n** is an instance number.

Default routes will match packets with any destination IP address (when in service).

If a default route is configured, packets with destination IP addresses that do not match any of the dynamic or static routes will be sent out the interface specified in the first **in service** default route.

Routing modes

The TransPort has two routing modes available, these are:

- **TransPort routing mode:** The original routing method provided on existing installations.
- **CIDR routing mode:** Enabled by default on most TransPort routers.

The command to switch between the two modes is:

```
ip 0 cidr [off|on]
```

TransPort routing mode

When you enable the TransPort routing mode, CIDR routing is disabled. When the router receives an IP packet to route, it uses the routing table to decide through which interface to send the packet. Usually the destination IP address of the IP packet is compared with the IP Address and Mask of each entry in the routing table in index order, regardless of the order in the routing table or length of mask. There may be more than one match, and in this case, the index number of the route is taken into account. The index number is simply the route number in the configuration. That is, Static Route **0** or **1** is index **0** or **1**.

The router checks static routes first, then dynamic routes, then default routes.

Command line

The command to enable TransPort routing mode is as follows:

```
ip 0 cidr off
```

CIDR routing mode

When the router receives an IP packet to route, it uses the routing table to decide through which interface to send the packet. Usually the destination IP address of the IP packet is compared with the IP Address and Mask of each entry in the routing table. There may be more than one match and in this case the router uses the most specific route to route the packet. For example, a the router uses a matching **/24** route before a matching **/16** route.

If multiple routes match the destination and have the same prefix length, the router uses the index number of the routes in the routing table to determine the route.

Command line

The command to enable CIDR routing mode is:

```
ip 0 cidr on
```

View the TransPort routing table

Web

Go to **Management > Network Status > IP Routing Table**.

Command line

Use the **route print** command:

```
route print
```

Destination	Gateway	Metric	Protocol	Idx	Interface	Status
10.10.14.0/24	10.10.14.68	1	Local	-	ETH 0	UP
10.182.120.188/30	10.182.120.189	1	Local	-	PPP 1	UP
0.0.0.0/0	10.10.14.1	2	Static	0	ETH 0	UP

```
OK
```

Configure route metrics

You can set route metric settings to override the order in which the routes are searched. The router always uses routes with lower metric numbers in preference to routes with higher metric numbers, even if the routes with higher metric numbers appear first in the routing table.

To configure route metrics, use the following route parameters:

- **Connected Metric:** The metric for a route when its interface is active.
- **Disconnected Metric:** The metric for a route when its interface is inactive.

Normally, both values should be the same, but in some advanced routing scenarios, it is necessary to use different values.

You can alter route metrics automatically according to various circumstances. This allows for automatic backup connection paths.

You can put routes and interfaces out of service. Whenever an interface is out of service (OOS), any route pointing at the interface is also out of service. Whenever a route is out of service, the metric value is set to **16** in TransPort routing mode and **17** in CIDR mode.

Configure IP routing parameters

Web

- Go to **Configuration > Network > IP Routing/Forwarding > IP Routing**.

▼ IP Routing

Enable CIDR routing
 For CIDR routing, you can specify an administrative distance for each route ty which is added to the route's metric in the routing table

Connected Interfaces:

Static Routes:

eBGP Routes:

OSPF Routes:

RIP Routes:

iBGP Routes:

Maximum static route metric:

Route directed IP broadcasts

Wait seconds before using an alternative route

If an interface is configured for "dial on demand" and fails to connect, Mark a static route as "Out Of Service" for seconds

When an "Always On" route becomes "In Service", wait seconds before using it

- Configure IP routing parameters:

Enable CIDR routing

When enabled, the following six text boxes are displayed:

Connected Interfaces

The CIDR metric that the router should apply to connected interfaces.

Static Routes

The CIDR metric that the router should use for static routes. The default is **1**.

eBGP Routes

The CIDR metric that the router should use for eBGP routes. The default is **20**.

OSPF Routes

The CIDR metric that the router should use for OSPF routes. The default is **110**.

RIP Routes

The CIDR metric that the router should use for RIP routing. The default is **120**.

iBGP Routes

The CIDR metric that the router should use for iBGP routes. The default is **200**.

Maximum static route metric

The maximum value for the routing metric. The default is **16**.

Route directed IP broadcasts

When enabled, this setting causes the router to route directed broadcasts. The default state for this parameter is **Off**. A directed broadcast is an IP packet with a destination address that is a valid broadcast address for a subnet but does not originate from that subnet. A broadcast sent from one interface to the subnet of another uses these directed IP broadcasts.

Wait *s* seconds before using an alternative route

The value in this text box specifies the latency to apply before passing traffic on an alternative route in the current route becomes unavailable.

If an interface is configured for “dial on demand” and fails to connect,**Mark a static route as “Out Of Service” for *s* seconds**

The value in this text box specifies the default time that a route should be marked as out of service if the interface it uses fails to establish a connection.

When an “Always On” route becomes “In Service”, wait *s* seconds before using it

The value in this text box specifies the delay that the router should apply to a route before passing traffic on it once it has come into service.

3. Click **Apply**.

 **Command line**

Command	Instance	Parameter	Values	Equivalent web parameter
ip	0	cidr	on,off	Enable CIDR routing

Command	Instance	Parameter	Values	Equivalent web parameter
ip	0	admin_connected	0-2147483647	Connected Interfaces
ip	0	admin_static	0-2147483647	Static Routes
ip	0	admin_ebgp	0-2147483647	eBGP Routes
ip	0	admin_ospf	0-2147483647	OSPF Routes
ip	0	admin_rip	0-2147483647	RIP Routes
ip	0	admin_ibgp	0-2147483647	iBGP Routes
ip	0	inf_metric	0-2147483647	Maximum static route metric
ip	0	route_dbcast	0-255	Route directed IP broadcasts
ip	0	route_dly	0-2147483647	Wait s seconds before using an alternative route
ip	0	route_dwn	0-2147483647	If an interface is configured for “dial on demand” and fails to connect, Mark a static route as Out Of Service for s seconds
ip	0	routeup_dly	0-2147483647	When an Always On route becomes In Service , wait s seconds before using it

Configure static routes

The static routing web pages and command line parameters described below control the static routing table the router uses. These settings create static IP routes for particular IP subnets, networks or addresses.

Web

1. Go to **Configuration > Network > IP Routing/Forwarding > Static Routes > Routes 0-9**.
2. Configure **Route n** parameters. Each of the static route instances has its own configuration page. These are described below.

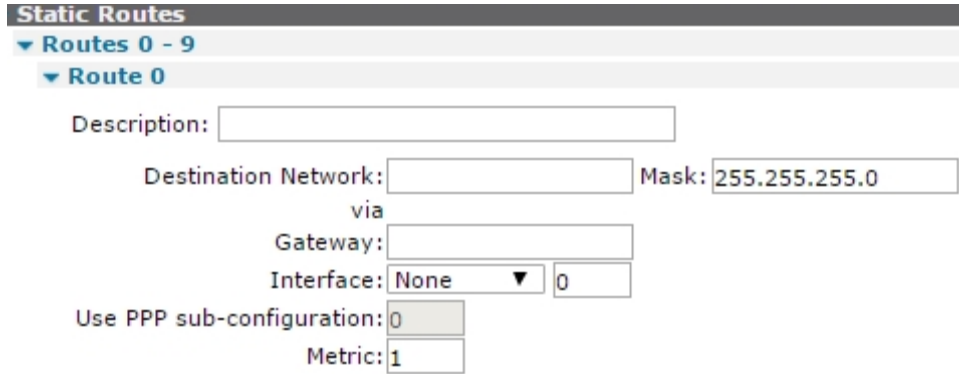

Static Routes

▼ Routes 0 - 9

▼ Route 0

Description:

Destination Network: Mask:

via

Gateway:

Interface:

Use PPP sub-configuration:

Metric:

Description

A memorable name for the route to be assigned.

Destination Network a.b.c.d

The IP address of the destination subnet, network or IP address for the route. If the router receives a packet with a destination IP address that matches the Destination Network/Mask combination it will route the packet through the interface specified below.

Mask a.b.c.d

The network mask.

Gateway a.b.c.d

Overrides the default gateway IP address configured for the Ethernet interfaces. Packets matching the route use the gateway address specified in the route rather than the address specified on the Ethernet interface configuration page. This parameter does **not** apply to routes using PPP interfaces.

Interface x,y

The interface for routing the packets. Select from the drop-down list and enter the interface instance number in the adjacent text box. The available options are:

- **None**
- **PPP**

- Ethernet
- Tunnel

Use PPP sub-configuration

If PPP sub-configurations are defined, this text displays in normal highlighting (such as not disabled out) and text box will accept the number for the desired sub-configuration to use on this route. This parameter will not appear on those models that do not support PPP sub-configurations.

Metric n

The routing metric to use when the interface is connected. This should have a value between **1** and **16**. The router uses this metric select which route to use when the subnet for a packet matches more than one of the IP route entries.

Each route can be assigned a **connected metric** and a **disconnected metric**. The connected metric parameter specifies the metric for a route whose interface is active. The disconnected metric specifies the metric for a route whose interface is inactive. Normally both values should be the same but in some advanced routing scenarios necessary to use different values.

If a particular route fails, it automatically has its metric set to **16**, which means that it is temporarily deemed as being out of service. The default out of service period is set by the IP route out of service parameter. Note however, that this default period may be overwritten in certain situations such as when a firewall stateful inspection rule specifies a different period. When a route is out of service, the router uses any alternative routes (with matching subnets) first.

3. Click **Apply**.

Command line

Command	Instance	Parameter	Values	Equivalent web parameter
route	n	descr	Up to 20 characters	Description
route	n	IPaddr	Valid IP address a.b.c.d	Destination Network a.b.c.d
route	n	mask	Valid netmask a.b.c.d	Mask a.b.c.d
route	n	gateway	Valid IP address a.b.c.d	Gateway
route	n	ll_ent	Blank,PPP,ETH,TUN	Interface x,y
route	n	ll_add	0-2147483647	Interface x,y
route	n	upmetric	0-2147483647	Metric

Advanced Static Route parameters

Go to **Configuration > Network > IP Routing/Forwarding > Static Routes > Routes 0-9 > Route n > Advanced**.

Web

Advanced

Use metric when the interface is not active

Use this route only if the source IP address of the packet matches
 IP Address:
 Mask:

Include this route in RIP advertisements

Make PPP interface use the alternative idle timeout when this route becomes available

Wait for seconds after power up before allowing this route to activate the interface

If the interface is configured for "dial on demand"
 Mark this route as "Out Of Service" if the interface fails to connect after consecutive attempts
 If the interface fails to connect, try again in seconds
 Deactivate the interface after it successfully connects
 Do not allow this interface to be activated by this route for seconds after last activation attempt

Only queue one packet whilst waiting for the interface to connect

When this route becomes available, deactivate the following interfaces
 after seconds
 after seconds

When this route becomes unavailable, deactivate the following interfaces
 after seconds
 after seconds

When this route becomes unavailable, remove the "Out Of Service" state on

Keep this route in service for seconds after OOS state is cleared

Assign this route to recovery group:

Apply

Use metric n when the interface is not active

The routing metric to use when the interface is not active.

Use this route only if the source IP address of the packet matches

When enabled, the following two parameters are enabled.

IP Address a.b.c.d

If necessary, use the IP Address and Mask parameters to further qualify the way in which the router routes packets. If the values in this text box and the **Mask** parameter are set, the source address of

the packet being routed must match these parameters before the packet will be routed through the specified interface.

Mask a.b.c.d

The netmask specified with the IP address as explained above.

Include this route in RIP advertisements

When enabled, the router includes this static route to be included in RIP advertisements.

Make PPP n interface use the alternative idle timeout when this route becomes available

When enabled, this check box, in conjunction with the PPP interface instance number in the text box, cause the router to use the alternative inactivity timeout specified for that interface when this route comes back into service. This feature is useful when it is preferable to close down a backup route quickly when a primary route comes back into service.

Wait for s seconds after power up before allowing this route to activate the interface

The delay the router should wait after power-up before packets matching this route will initiate a connection of the interface configured in the route. W-WAN routers that have ISDN backup use this setting to prevent unnecessary ISDN connections from being made while a W-WAN connection is first being established.

Mark this route as “Out of Service” in the interface fails to connect after n consecutive attempts

Normally, if an interface is requested to connect by a route and fails to connect, the route metric is set to 16 for the period of time specified by the Mark a static route as **Out Of Service for s seconds** parameter on the **Configuration > Network > IP Routing/Forwarding > IP Routing** page. If the value in this text box is non-zero, the route metric will not be set to **16** until the number of connection attempts specified by this parameter have been made.

If the interface fails to connect, try again in s seconds

If an interface is requested to connect by this route (due to IP traffic being present) and it fails to connect, the route will be marked as out of service but the router will continue to attempt to connect at the interval specified by the value in this text box. If the interface does connect, the router will clear the out of service status for the route.

Deactivate the interface after it successfully connects

When enabled, the router deactivates an interface once a successful activation attempt has been made. Specified with the above retry parameter. If the above retry parameter is not set, this setting is disabled.

Do not allow this interface to be activated by this route for s seconds after the last activation attempt

The delay to wait before re-initiating a connection after it has dropped while still required.

Only queue one packet while waiting for the interface to connect

When enabled, the router enqueues only one packet while waiting for the interface to connect. When unchecked, the router will enqueue two packets.

When this route becomes available, deactivate the following interfaces x,y x,y

The interfaces specified by the values in these two pairs of drop-down list and text boxes are deactivated when this route becomes available again after being out of service. The router typically uses this feature to deactivate backup interfaces when the primary interface becomes available after being out of service. Select the required interface from the drop-down list and enter the interface instance number into the text box as usual.

When this route becomes unavailable, remove the “Out of Service” state on x,y

The interface and instance that should be taken out of the **Out of Service** state when the interface that this route is configured to use is deactivated. Available interface options are **None, PPP, Ethernet, and Tunnel**

Keep this route in service for s seconds after OOS state is cleared

When enabled, the following text box is enabled (such as it is no longer disabled), allowing a value to be entered. The value specifies the period that the interface specified above will remain in service even though it is actually unable to pass traffic immediately. This is behavior useful in situations where a PPP interface is activating and traffic should not try the next interface until this one has been allowed a certain amount of time to come up. When this timer expires, if the interface is unable to pass traffic, it will be marked **Out of Service** and the next interface will be tried.

Assign this route to recovery group n

Assigns the route to a recovery group. This means that if all the routes in a particular recovery group go out of service, the out of service status is cleared for all routes in that group. If one route in a group comes back into service, all routes with a lower priority (metric) also have their out of service status cleared.

Related CLI commands

 **Command line**

Command	Instance	Parameter	Values	Equivalent web parameter
route	n	metric	0-2147483647	Use metric n when the interface is not active
route	n	srcip	Valid IP address a.b.c.d	IP Address a.b.c.d

Command	Instance	Parameter	Values	Equivalent web parameter
route	n	srcmask	Valid netmask a.b.c.d	Mask a.b.c.d
route	n	inrip	on,off	Include this route in RIP advertisements
route	n	doinact2	on,off	Make PPP n interface use the alternative idle timeout when this route becomes available
route	n	inact2add	0-2147483647	Make PPP n interface use the alternative idle timeout when this route becomes available
route	n	pwr_dly	0-255	Wait for s seconds after power up before allowing this route to activate the interface
route	n	actoolim	0-2147483647	Mark this route as Out Of Service if the interface fails to connect after n consecutive attempts
route	n	chkoos_int	0-2147483647	If the interface fails to connect, try again in s seconds
route	n	chkoos_deact	0-255	Deactivate the interface after it successfully connects

Command	Instance	Parameter	Values	Equivalent web parameter
route	n	dial_int	0-255 Default 10	Do not allow this interface to be activated by this route for s seconds after the last activation attempt
route	n	q1	on,off	Only queue one packet whilst waiting for the interface to connect
route	n	deact_ent	Blank,PPP	When this route becomes available, deactivate the following interfaces x,y
route	n	deact_add	0-2147483647	When this route becomes available, deactivate the following interfaces x,y
route	n	deact_ent2	Blank,PPP	When this route becomes available, deactivate the following interfaces x,y
route	n	deact_add2	0-2147483647	When this route becomes available, deactivate the following interfaces x,y
route	n	unoos_secs	0-2147483647	Keep this route in service for s seconds after OOS state is cleared

Command	Instance	Parameter	Values	Equivalent web parameter
route	n	rgroup	0-255	Assign this route to recovery group n

Configure default IP routes

The following web pages and associated command line commands set up default IP routes that route non-local IP addresses not specified in a static route. The parameters are identical to those on the static route pages with the exception that there are no IP address or Mask parameters.

Web

1. Go to **Configuration > Network > IP Routing/Forwarding > Static Routes > Default Route n**.

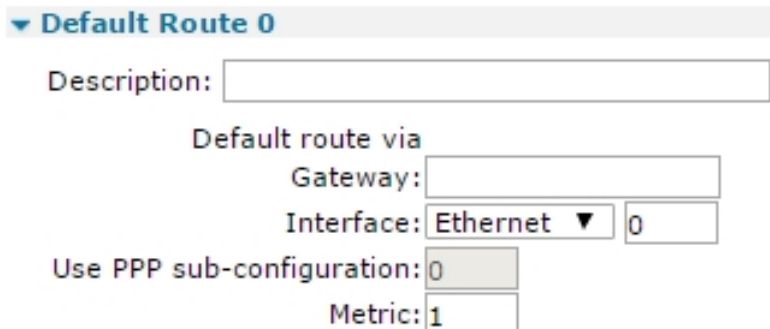

▼ **Default Route 0**

Description:

Default route via

Gateway:

Interface:

Use PPP sub-configuration:

Metric:

2. Configure the default route parameters:

Description

Assigns a convenient and memorable description for the route.

Default route via:

Gateway a.b.c.d

Used to override the default gateway IP address configured for the Ethernet interfaces. Packets matching the route will use the gateway address specified in the route rather than the address specified on the Ethernet interface configuration page. This parameter does not apply to routes using PPP interfaces.

Interface x,y

The interface and interface number for routing the packets. Available options are:

- None
- PPP
- Ethernet
- Tunnel

Metric n

The routing metric to use when the interface is connected. This should have a value between **1** and **16**. It selects which route to use when the subnet for a packet matches more than one of the IP route entries.

Each route may be assigned a **connected metric** and a **disconnected metric**. The **connected metric** parameter specifies the metric for a route whose interface is active. The **disconnected metric** specifies the metric for a route whose interface is inactive. Normally both values should be the same, but in some advanced routing scenarios, it is necessary to use different values.

If a particular route fails, it will automatically have its metric set to **16** which means that it is temporarily deemed as being out of service. The default out of service period is set by the IP route out of service parameter. Note that this default period may be overwritten in certain situations such as when a firewall stateful inspection rule specifies a different period. When a route is out of service, the router uses any alternative routes (with matching subnets) first.

3. Click **Apply**.

 **Command line**

Command	Instance	Parameter	Values	Equivalent web parameter
def_route	n	descr	Up to 20 characters	Description
def_route	n	gateway	Valid IP address a.b.c.d	Gateway a.b.c.d
def_route	n	ll_ent	Blank,PPP,ETH,TUN	Interface x,y
def_route	n	ll_add	0-2147483647	Interface x,y
def_route	n	upmetric	1-16	Metric

Advanced Default route parameters

 **Web**

Go to **Configuration > Network > IP Routing/Forwarding > Static Routes > Default Route n > Advanced**.

Advanced

Use metric when the interface is down

Use this route only if the source IP address of the packet matches
 IP Address:
 Mask:

Include this route in RIP advertisements

Make PPP interface use the alternative idle timeout when this route becomes available

Wait for seconds after power up before allowing this route to activate the interface

If the interface is configured for "dial on demand"
 Mark this route as "Out Of Service" if the interface fails to connect after consecutive attempts
 If the interface fails to connect, try again in seconds
 Deactivate the interface after it successfully connects
 Do not allow this interface to be activated by this route for seconds after last activation attempt

Only queue one packet whilst waiting for the interface to connect

When this route becomes available, deactivate the following interfaces
 after seconds
 after seconds

When this route becomes unavailable, deactivate the following interfaces
 after seconds
 after seconds

When this route becomes unavailable, remove the "Out Of Service" state on

Keep this route in service for seconds after OOS state is cleared

Assign this route to recovery group:

Use metric n when the interface is not active

The routing metric to use when the interface is not active.

Use this route only if the source IP address of the packet matches

When enabled, the following two parameters are enabled:

IP address a.b.c.d

If necessary, use this parameter **IP Address** and the **Mask** parameter to further qualify the way in which the router routes packets. If the values in this text box and the **Mask** parameter are set, the source address of the packet being routed must match these parameters before the packet will be routed through the specified interface.

Mask a.b.c.d

The netmask specified with the IP address as explained above.

Include this route in RIP advertisements

When enabled, the router includes this static route to be included in RIP advertisements.

Make PPP x interface use the alternative idle timeout when this route becomes available

When enabled, this check box, in conjunction with the PPP interface instance number in the text box, cause the router to use the alternative inactivity timeout specified for that interface when this route comes back into service. This feature is useful when it is preferable to close down a backup route quickly when a primary route comes back into service.

Wait for s seconds after power up before allowing this route to activate the interface

The delay that the router should wait after power-up before packets matching this route will initiate a connection of the interface configured in the route. W-WAN routers that have ISDN backup typically use this setting to prevent unnecessary ISDN connections from being made while a W-WAN connection is first being established.

If the interface is configured for “dial on demand”**Mark this route as “Out Of Service” if the interface fails to connect after n consecutive attempts**

Normally, if an interface is requested to connect by a route and fails to connect, the route metric is set to 16 for the period of time specified by the **Mark a static route as Out Of Service for s seconds** parameter on the **Configuration > Network > IP Routing/Forwarding > IP Routing** page. If the value in this text box is non-zero, the route metric will not be set to 16 until the number of connection attempts specified by this parameter have been made.

If the interface fails to connect, try again in s seconds

If an interface is requested to connect by this route (due to IP traffic being present) and it fails to connect, the route will be marked as out of service but the router will continue to attempt to connect at the interval specified by the value in this text box. If the interface does connect, the router will clear the out of service status for the route.

Deactivate the interface after it successfully connects

When enabled, the router deactivates an interface once a successful activation attempt has been made. The router uses this setting with the above retry parameter. If the above retry parameter is not set, this setting is disabled.

Do not allow this interface to be activated by this route for s seconds after the last activation attempt

The delay to wait before re-initiating a connection after it has dropped while still required.

Only queue one packet whilst waiting for the interface to connect

When enabled, the router enqueues only one packet while waiting for the interface to connect. When unchecked, the router enqueues two packets.

When this route becomes available, deactivate the following interfaces x,y x,y

The interfaces specified by the values in these two pairs of drop-down list and text boxes will be deactivated when this route becomes available again after being out of service. The router typically uses this feature to deactivate backup interfaces when the primary interface becomes available after being out of service. Select the required interface from the drop-down list and enter the interface instance number into the text box as usual.

When this route becomes unavailable, remove the “Out Of Service” state on x,y

The interface and instance that should be taken out of the **Out of Service** state when the interface that this route is configured to use is deactivated. Available interface options are **None**, **PPP**, **Ethernet**, and **Tunnel**.

Keep this route in service for s seconds after OOS state is cleared

When enabled, the following text box is enabled (such as it is no longer disabled out), allowing a value to be entered. The value specifies the period that the interface specified above will remain in service even though it is actually unable to pass traffic immediately. This is behavior useful in situations where a PPP interface is activating and traffic should not try the next interface until this one has been allowed a certain amount of time to come up. When this timer expires, if the interface is unable to pass traffic, it is marked **Out of Service** and the next interface is tried.

Assign this route to recovery group n

Used to assign the route to a recovery group. This means that if all the routes in a particular recovery group go out of service, the out of service status is cleared for all routes in that group. If one route in a group comes back into service, all routes with a lower-priority (metric) also have their **Out of Service** status cleared.

 **Command line**

Command	Instance	Parameter	Values	Equivalent web parameter
def_route	n	metric	0-2147483647	Use metric n when the interface is not active
def_route	n	srcip	Valid IP address a.b.c.d	IP Address a.b.c.d
def_route	n	srcmask	Valid netmask a.b.c.d	Mask a.b.c.d
def_route	n	inrip	on,off	Include this route in RIP advertisements
def_route	n	doinact2	on,off	Make PPP n interface use the alternative idle timeout when this route becomes available

Command	Instance	Parameter	Values	Equivalent web parameter
def_route	n	inact2add	0-2147483647	Make PPP n interface use the alternative idle timeout when this route becomes available
def_route	n	pwr_dly	0-255	Wait for s seconds after power up before allowing this route to activate the interface
def_route	n	actoolim	0-2147483647	Mark this route as “Out Of Service” if the interface fails to connect after n consecutive attempts
def_route	n	chkoos_int	0-2147483647	If the interface fails to connect, try again in s seconds
def_route	n	chkoos_deact	0-2147483647	Deactivate the interface after it successfully connects
def_route	n	dial_int	0-255 Default 10	Do not allow this interface to be activated by this route for s seconds after the last activation attempt
def_route	n	q1	on,off	Only queue one packet whilst waiting for the interface to connect
def_route	n	deact_ent	Blank,PPP	When this route becomes available, deactivate the following interfaces x,y
def_route	n	deact_add	0-2147483647	When this route becomes available, deactivate the following interfaces x,y
def_route	n	deact_ent2	Blank,PPP	When this route becomes available, deactivate the following interfaces x,y
def_route	n	deact_add2	0-2147483647	When this route becomes available, deactivate the following interfaces x,y
def_route	n	unoos_secs	0-2147483647	Keep this route in service for s seconds after OOS state is cleared
def_route	n	rgroup	0-255	Assign this route to recovery group n

Configure Routing Information Protocol (RIP) settings

The web pages and command line commands described in this section control the configuration of the Routing Information Protocol (RIP) behavior of the router.

Configure global RIP Settings

Web

1. Go to **Configuration > Network > IP Routing/Forwarding > RIP > Global RIP Settings**.



▼ RIP
 ▼ Global RIP Settings

- Enable RIP
 - Send RIP advertisements every seconds
 - Mark routes as unusable if we don't get advertisement for seconds
 - Delete routes after another seconds
- Allow RIP to update static routes
- Enable Poison Reverse

2. Configure the RIP parameters:

Enable RIP

When enabled, enables the RIP functionality.

Send RIP advertisements every *s* seconds

The interval between sending RIP packets. These packets contain the current routes held by the router (such as any active PPP routes), static routes and the default route. A value of **0** disables sending.

Mark routes as unusable if we don't get advertisements for *s* seconds

The time for which an updated metric will apply when a RIP update is received. If no updates are received within this period, the usual metric will take over.

Delete routes after another *s* seconds

The length of time that the router will continue to advertise this route when a RIP update timeout occurs and the route metric is **16**. This behavior is designed to help propagate the dead route to other routers. The router will no longer use a metric advertised by a RIP update if the route has been set out of service locally.

Allow RIP to update static routes

When enabled, allows an incoming, matching RIP update to change the metric of the static route. This happens when the update matches a configured static route.

Enable Poison Reverse

When enabled, enables poison reverse, to notify when a neighboring router is unavailable.

3. Click **Apply**.

 **Command line**

Command	Instance	Parameter	Values	Equivalent web parameter
rip	n	enable	on,off	Enable RIP
rip	n	interval	0-2147483647	Send RIP advertisement every s seconds
rip	n	ripto	0-2147483647	Mark routes as unusable if we don't get advertisement for s seconds
rip	n	riplingerto	0-2147483647	Delete routes after another s seconds
rip	n	updatestatic	on,off	Allow RIP to update static routes
rip	n	poisonreverse	on,off	Enable Poison Reverse

Configure access lists

The router can modify route metrics based upon received RIP responses. Static routes and default routes have their metric modified if the route fits within one of the routes found within the RIP packet. For Ethernet routes, the gateway for the route will be set to the source address of the RIP packet. The route modifications will be enforced for **180** seconds, unless another RIP response is received within that time.

RIP packets must have a source address that is included in the RIP access list.

Adding permitted IP addresses to the access list is controlled using a table with the single parameter described below.

 **Web**

Go to **Configuration > Network > IP Routing/Forwarding > RIP > Global RIP Settings > Access Lists**.

Access Lists

With the access list, you can control which devices can send RIP advertisements to this TransPort router.
 Allow RIP advertisements from the following IP addresses.
 (you may specify up to 10 addresses):

IP Address
No IP addresses have been added
<input type="text"/> <input type="button" value="Add"/>

IP Address a.b.c.d

The IP address to be added to the list of IP addresses that RIP packets must come from if they are to modify route metrics. Up to ten IP addresses may be added. The **Add** and **Delete** buttons work in the usual way for configuration tables.

 **Command line**

Command	Instance	Parameter	Values	Equivalent web parameter
riprx	0-9	IPaddr	Valid IP address a.b.c.d	IP Address a.b.c.d

Configure authentication keys

Go to **Configuration > Network > IP Routing/Forwarding > RIP > Global RIP Settings > Authentication Keys**.

The router uses RIP authentication keys with the plain password and MD5 RIP authentication methods.

 **Web**



Key k

The RIP authentication key. Enter a string of up to **16** characters long. A current key will not be displayed.

Confirm Key

Re-enter the new authentication key into this text box to allow the router to check that the two are identical.

Key ID (MD5 only)

The ID for the authentication key. The ID is inserted into the RIP packet when using RIP v2 MD5 authentication in looking up the correct key for received packets. The valid range is **0-255**.

Valid from now/dd,mm,yy

These two radio buttons select between having the validity period for the key starting immediately or allowing a start date to be defined. The starting date is specified using a drop down list to select the start day, a drop-down list to select the start month and a text box to enter the start year. Selecting the **Disable** option from the day and **None** from the month means to not use this key. To specify the year, enter two or four digits, such as **11** or **2011**.

Expires Never/dd,mm,yy

These two radio buttons select between defining the end date using the drop-down lists and text box or by setting the expiration to **Never**. The key end day is selected from the first drop down list. Selecting **Disable** means to not use the key. Select the end month from the second drop-down list. Selecting **None** means that to not use the key should. To specify the year, enter two or four digits, such as **11** or **2011**.

 **Command line**

Command	Instance	Parameter	Values	Equivalent web parameter
ripauth	0-9	key	Up to 16 characters	Key k
ripauth	0-9	keyid	0-255	Key ID
ripauth	0-9	sday	0-31	Valid from d,m,y
ripauth	0-9	smon	0-12	Valid from d,m,y
ripauth	0-9	syear	0-65535	Valid from d,m,y
ripauth	0-9	eday	0-31	Expires d,m,y
ripauth	0-9	emon	0-12	Expires d,m,y
ripauth	0-9	eyear	0-65535	Expires d,m,y

Configure RIP advertisements

 **Web**

Go to

The configuration in the **Interfaces > Ethernet, Interfaces > PPP, and Interfaces > GRE** sub-menus is identical. Following are the settings for **Ethernet > ETH 0**:

Interfaces

- Ethernet**
- ETH 0**

Send RIP advertisements on this interface

Use RIP v1

Send RIP advertisements as Broadcasts

Use Authentication None Access list Plain password (V1+V2) MD5 (V2 only)

Only send RIP advertisements when this interface is in service

Include this interface in RIP advertisements

Apply

Send RIP advertisements on this interface

Check this box to enable RIP and to reveal further configuration parameters below.

Use RIP

RIP version level. Select from the values **V1**, **V2**, and **V1 Compat** (version 1-compatible). When RIP version is set to **V1** or **V2**, the router will transmit RIP version 1 or 2 packets respectively (version 2 packets are sent to the all routers multicast address 224.0.0.9). When RIP Version is set to **V1**

Compat, the router will transmit RIP version 2 packets to the subnet broadcast address. This allows V1-capable routers to act upon these packets.

Send RIP advertisements as

- **Broadcasts:** RIP packets are by default sent out on a broadcast basis or to a multi-cast address. Do not change this parameter unless you intend to alter this behavior.
- **Multicasts** (Only visible when **V2** is selected in the **Use RIP** option above): This is automatically selected for sending to the default RIP v2 multicast address **224.0.0.9**.
- **<BLANK BOX>**: Forces RIP packets to be sent to a specified IP or multicast address. This setting is particularly useful if you need to route the packets via a VPN tunnel. By default, Broadcasts/multicasts are selected, depending on your RIP version.

Use Authentication:

Selects the authentication method for RIP packets. Only one option is enabled multiple selections are not possible.

None

When set to Off, the interface sends and receives packets without any authentication.

Access list

When set to Access List, the interface sends RIP packets without any authentication. When receiving packets, the interface checks the sender's IP address against the list entered on the **Configuration > Network > IP Routing / Forwarding > RIP > Global RIP settings > Access Lists** page, and if the IP address is present in the list, the packet is allowed through.

Plain password

When set to Plain password (V1+V2), the interface uses the first valid key it finds (set on the Configuration > Network > IP Routing / Forwarding > RIP > Global RIP settings > Authentication Keys > Authentication Key n pages), and use the plain text RIP authentication method before sending the packet out. If no valid key can be found, the interface will not send any RIP packets. When receiving a RIP packet, a valid plain text key must be present in the packet before it will be accepted. You can use this method with both RIP V1 and RIP V2.

MD5

When set to MD5 (V2 only), the interface uses the first valid key it finds (set on the **Configuration > Network > IP Routing / Forwarding > RIP > Global RIP settings > Authentication Keys > Authentication Key n** pages), and uses the MD5 authentication algorithm before sending the packet out. If no valid key can be found, the interface will not send any RIP packets. Received RIP packets must be authenticated using the MD5 authentication algorithm before they will be accepted. You can use this method with RIP V2.

Only send RIP advertisements when this interface is in service

Select this parameter for RIP advertisements only to be sent when the interface is in the **UP** state in the routing table.

Use Triggered RIP on this interface

Enables triggered RIP (RFC2091). When triggered RIP is enabled, RIP timers are disabled.

Include this interface in RIP advertisements

Select to cause the subnet configured on this interface to not be advertised by RIP.

 **Command line**

Command	Instance	Parameter	Values	Equivalent web parameter
tun/ ppp	n	rip	0, 1	Enable RIP=1 Disable RIP=0
tun/ ppp	n	ripip	Valid IP address a.b.c.d	0=None 1=Access List 2=Plain Password 3=MD5 v2 only
tun/ ppp	n	ripauth	0-3	Key number
tun/ ppp	n	ripis	on,off	Turn on to send updates only when in service
tun/ ppp	n	inrip	on,off	Include interface subnet in RIP advertisements
tun/ ppp	n	triggeredrip	on,off	Enable RIP RFC2091

Configure Open Shortest Path First (OSPF) parameters

Open Shortest Path First (OSPF) is an Interior Gateway Protocol (IGP) developed for IP networks based on the shortest path first or link-state algorithm.

The router uses link-state algorithms to send routing information to all nodes in a network by calculating the shortest path to each node based on a topography of the network constructed by each node. Each router sends that portion of the routing table that describes the state of its own links and the complete routing structure (network topography).

The advantage of the shortest path first algorithms is that they result in smaller, more frequent update everywhere. They converge quickly, thus preventing such problems as routing loops and Count-to-Infinity (where routers continuously increment the hop count to a particular network). This makes for a stable network.

To use OSPF on the router, a valid configuration file must exist in the router's filing system.

Web

1. Go to **Configuration > Network > IP Routing/Forwarding > OSPF**.

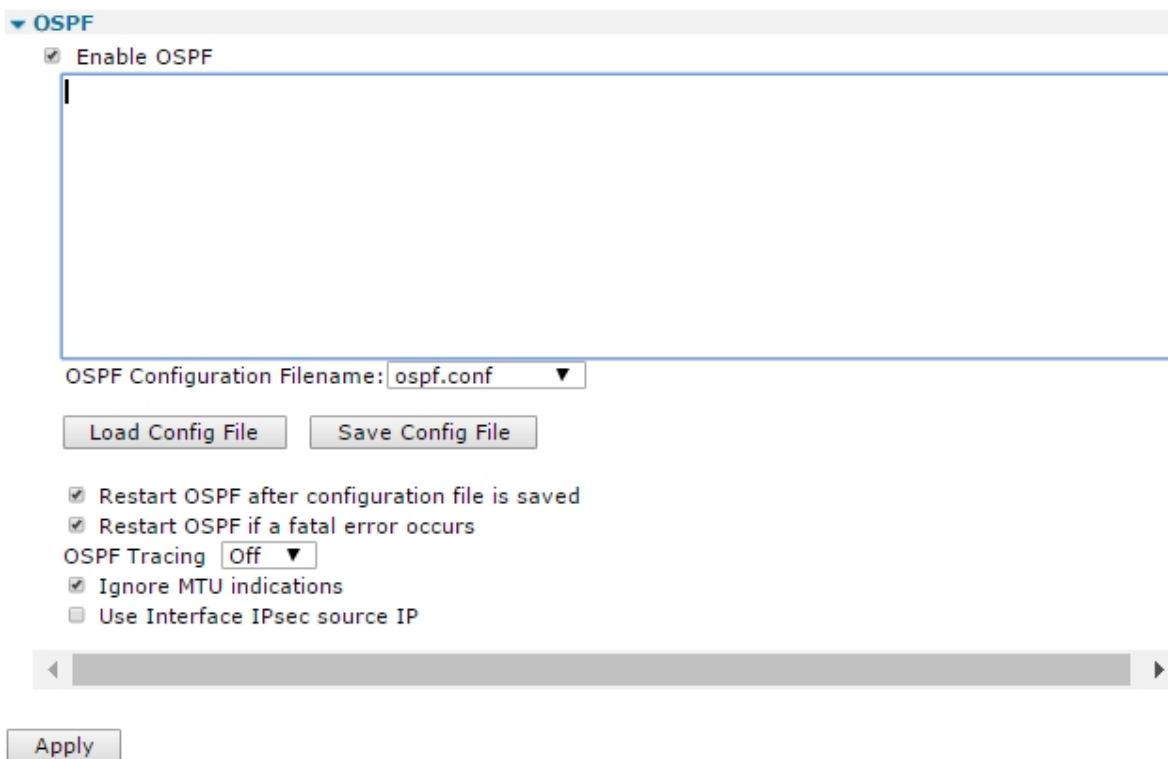

▼ OSPF

Enable OSPF

OSPF Configuration Filename:

Restart OSPF after configuration file is saved

Restart OSPF if a fatal error occurs

OSPF Tracing

Ignore MTU indications

Use Interface IPsec source IP

2. Configure the OSPF parameters:

Enable OSPF

When enabled, displays the following parameters:

OSPF Configuration Filename

The file that contains the configuration data for OSPF is selected from this drop-down list. The file should have a **.conf** extension.

Load Config file

When this button is clicked, the router attempts to load the file specified in the file selection list box into the edit window below the button. The text in the window can be edited as required.

Save Config File

Saves the text in the edit window to the filename specified in the drop-down list above. These three controls allow loading, editing, and saving an OSPF configuration file.

Restart OSPF after configuration file is saved

When enabled, restarts the OSPF functions once the edited configuration file has been saved.

Restart OSPF if a fatal error occurs

When enabled, restarts OSPF functioning after a delay of 5 seconds if a fatal error occurs.

OSPF Tracing

In common with some of the other functionality of the router, OSPF supports some debug functionality. The amount of information in the debug traces is controlled from this drop-down list. The available levels are **Off**, **Low**, **Med**, and **High**. Selecting **Off** disables debug tracing.

Ignore MTU indications

All OSPF routers must have the same Maximum Transmitted Unit (MTU) and this value is advertised in the OSPF packets. When checked, the router ignores received packets that have a MTU that differs from that of the router itself.

Use Interface IPsec source IP

When enabled, OSPF functions use the source IP address of the interface specified in **Configuration > Network > Interfaces > Advanced > PPP n: Use interface x,y for the source IP address of IPsec packets on the interface being used**. When unchecked, OSPF uses the source IP address of the interface in use for its source address.

3. Click **Apply**.

 **Command line**

Command	Instance	Parameter	Values	Equivalent web parameter
ospf	0	Enable	on,off	Enable OSPF
ospf	0	conffile	filename	OSPF Configuration Filename

Command	Instance	Parameter	Values	Equivalent web parameter
ospf	0	new_cfg_rest	on,off	Restart OSPF after a configuration file is saved
ospf	0	fatal_rest	on,off	Restart OSPF if a fatal error occurs
ospf	0	debug	0-3 0=Off 1=Low 2=Med 3=High	OSPF Tracing
ospf	0	ignore_mtu	on,off	Ignore MTU indications
ospf	0	useipsecent	on,off	Use Interface IPsec source IP

Configure Border Gateway Protocol (BGP) settings

The Border Gateway Protocol (BGP) routing protocol is supported by TransPort routers. This page contains the configuration parameters controlling the behavior of BGP. Most of the configuration is controlled by a configuration file (raw text) named **bgp.cnf**. This file would normally be created in a text editor on a computer and loaded onto the router. The router contains a simple editor for modifying the **bgp.cnf** file. The configuration parameters described here mainly define what action is to be taken when errors occur, and specify the configuration file to use.

Web

1. Go to **Configuration > Network > IP Routing/Forwarding > BGP**.

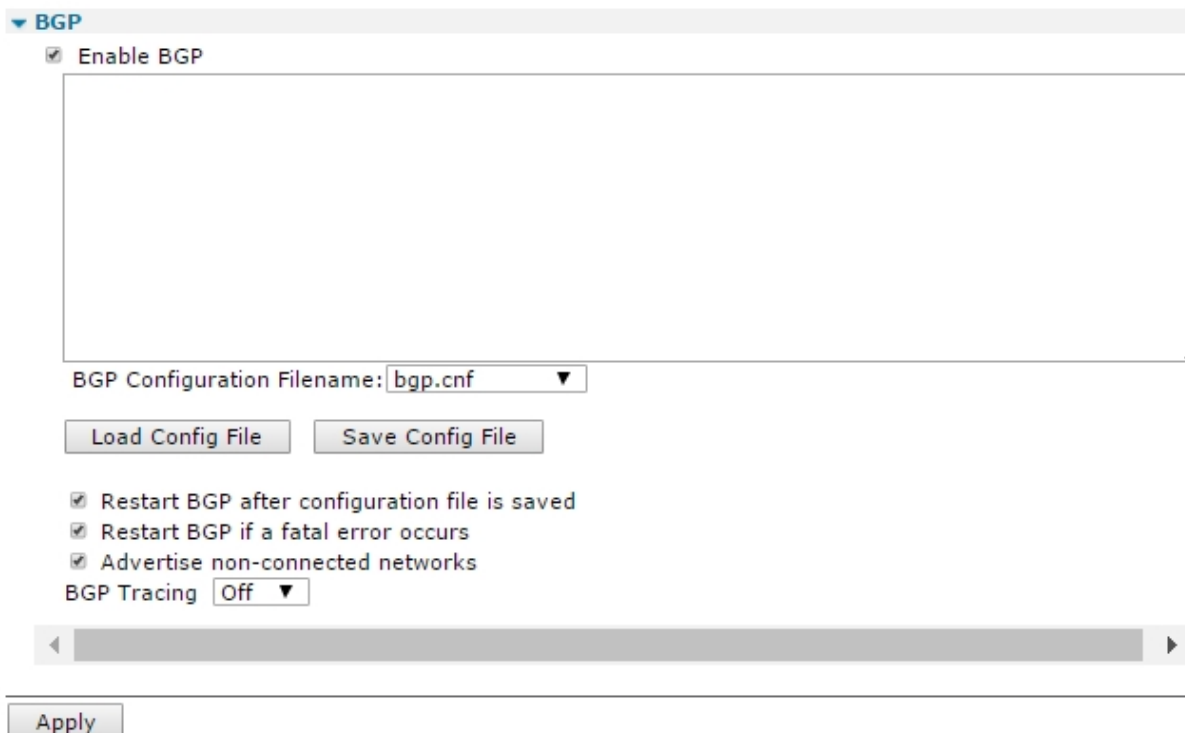

▼ BGP

Enable BGP

BGP Configuration Filename:

Restart BGP after configuration file is saved

Restart BGP if a fatal error occurs

Advertise non-connected networks

BGP Tracing

2. Configure the BGP parameters:

Enable BGP

When enabled, enables BGP routing.

BGP Configuration Filename

The configuration file to use is selected from this drop-down list. The default filename is **bgp.cnf**. An error message will be displayed if the specified file cannot be found.

Load Config file

Click this button to load the file specified from the drop-down list. The contents of the file will be visible in the edit window which appears below the button.

Save Config File

Saves the bgp.cnf file back to the filing system. Use if you have edited the file.

Restart BGP after configuration file is saved

When enabled, the router restarts routing using BGP after the file has been saved using the above **Save** button.

Restart BGP if a fatal error occurs

When enabled, the router restarts routing using BGP if a fatal error occurs.

Advertise non-connected networks

When enabled, BGP advertises networks that exist in the BGP configuration file but that are not actually a connected network or interface.

BGP Tracing

As with OSPF, the level of debug tracing information is selected from this drop-down list. The available levels are; **Off**, **Low**, **Med**, and **High**.

3. Click **Apply**.

 **Command line**

Command	Instance	Parameter	Values	Equivalent web parameter
bgp	0	enable	on,off	Enable BGP
bgp	0	conffile		BGP Configuration Filename
bgp	0	new_cfg_rest	on,off	Restart BGP after configuration file is saved
bgp	0	fatal_rest	on,off	Restart BGP if a fatal error occurs
bgp	0	allow_non_nets	on,off Default on	Advertise non-connected networks
bgp	0	debug	0-3	BGP Tracing

Configure IP port forwarding and static NAT mappings

The router supports Network Address Translation (NAT) and Network Address and Port Translation (NAPT). NAT or NAPT may be enabled on a particular interface such as a PPP instance. When operating with NAT enabled, this interface has a single externally visible IP address. When sending IP packets, the local IP addresses (for example on a local area network) are replaced by the single IP address of the interface. The router keeps track of the local IP addresses and port numbers so that if a matching reply packet is received, it is directed to the correct local IP address. With only one externally visible IP address, NAT effectively prevents external computers from addressing specific local hosts, thus providing a very basic level of “firewall” security.

Static NAT mappings allow received packets destined for particular ports to be directed to specific local IP addresses. For example, to have a server, running on a local network, externally accessible, a static NAT mapping would be set up using the local IP address of the server and the port number for accessing the required service.

Web

1. Go to **Configuration > Network > IP Routing/Forwarding > IP Port Forwarding/Static NAT Mappings**.

▼ IP Port Forwarding/Static NAT Mappings

Forward connections from external networks to the following internal devices. In order to forward to an internal port, an interface must have its NAT configuration set to "IP address and Port".

(you may configure up to 30 forwarding rules):

External Min Port	External Max Port	Forward to Internal IP Address	Forward to Internal Port	
No mappings have been configured				
<input type="text"/>	<input type="text"/>	<input type="text"/>	<input type="text"/>	<input type="button" value="Add"/>

2. Enter the following configuration values into the table

External Min Port

The lowest port number to be redirected.

External Max Port

The highest port number to be redirected.

Forward to Internal IP Address a.b.c.d

The IP address to which packets containing the specified destination port number are to be redirected.

Forward to Internal Port

The IP port number to which packets containing the specified port number are to be redirected. When set to **0**, no port remapping occurs and the router uses the original port number. The NAT mode parameter of the appropriate interface must be set to **NAPT** rather than **NAT** or **OFF** for this parameter to take effect.

Add button

Adds the port forwarding rule to the IP routing configuration.

3. Click **Add** to add each NAT mapping into the NAT configuration for the router.
4. Click **Apply**.

 **Command line**

Command	Instance	Parameter	Values	Equivalent web parameter
nat	0-29	minport	0-65535	External Min Port
nat	0-29	maxport	0-65535	External Max Port
nat	0-29	IPaddr	Valid IP address a.b.c.d	Forward to Internal IP Address a.b.c.d
nat	0-29	mapport	0-65535	Forward to Internal Port

Command format

The format for **nat** commands is:

```
nat <entry> <parameter> <value>
```

Example commands

To set the IP address for entry 0 in the table to **10.1.2.10**, enter the command:

```
nat 0 IPaddr 10.1.2.10
```

Configure multicast routes

Digi TransPort routers support multicast routes, allowing them to route packets to multicast group addresses. You can configure up to **20** different static multicast routes.

Use static multicast routes in conjunction with the IGMP parameter on the outbound interface. For example, after configuring a static multicast route for multicast traffic via PPP 1, the IGMP parameter in **Configuration > Network > Interfaces > IGMP** must be set to **On**.

Web

1. Go to **Configuration > Network > IP Routing/Forwarding > Multicast Routes**.
2. Configure the multicast routing table by entering the following parameters.

▼ Multicast Routes

You may configure up to 20 multicast routes

Multicast Address	Mask	Interface
No multicast routes have been configured		
<input type="text"/>	<input type="text"/>	PPP <input type="text"/> <input type="button" value="Add"/>

Enable multicast source path checking

Multicast Address a.b.c.d

Specified with the **Mask** parameter below, to identify the destination multicast group address for packets that will match this route. Therefore, if a router receives a packet with a destination multicast group address that matches the specified **Multicast Address/Mask** combination, it routes that packet through the interface specified by the **Interface** parameters below.

Mask a.b.c.d

The address mask specified with the **Multicast Address** parameter as described above.

Interface x,y

These two parameters in the drop-down list and adjacent text box specify the interface and interface instance for routing packets matching the **Multicast Address/Mask** combination. The options available in the drop-down list are; **PPP, Ethernet, Tunnel**.

Enable multicast source path checking

If enabled, the router checks the source address of any multicast packets received to determine whether the packet has arrived from the most direct path. The router performs this check by doing a route look-up on the source address, and comparing the lookup results with the interface on which the packet arrived. If the interfaces are the same, the router accepts

this multicast packet. Otherwise, the router drops the packet, as the packet is likely to be a copy, and the router has already received the original.

Add button

Adds the multicast route to the IP configuration.

3. Click **Add** to add each multicast route to the multicast routing table.
4. Click **Apply**.

Command line

Command	Instance	Parameter	Values	Equivalent web parameter
mcast	0-19	IPaddr	Valid IP address a.b.c.d	Multicast Address a.b.c.d
mcast	0-19	mask	Valid IP address a.b.c.d	Mask a.b.c.d
mcast	0-19	ll_ent	PPP,ETH,TUN	Interface x,y
mcast	0-19	ll_add	Valid interface number 0-2147483647	Interface x,y
mcast	0	mult_spc	ON, OFF	Enable multicast source path checking

Configure Virtual Routing and Forwarding (VRF)

Virtual Routing and Forwarding (VRF) is used to allow multiple instances of a routing table on the same router at the same time. Using VRF, you can create multiple routing tables and assign each interface to a different VRF. Because the routing instances are independent, you can use the same or overlapping IP addresses without conflict. VRF also refers to a routing table instance that can exist in one or multiple instances per each VPN on a Provider Edge (PE) router. A licensing file is available upon request, free of charge, to enable VRF.

Support for Virtual Routing and Forwarding in the web and command-line interfaces

TransPort routers support Virtual Routing and Forwarding on Ethernet, GRE, and PPP interfaces. Configuration support for PPP interfaces is command-line only.

Web

In the web interface, TransPort routers that have VRF support have additional configuration parameters for Ethernet and GRE tunnel interfaces.

Configure VRF for Ethernet interfaces

For Ethernet interfaces, these parameters are on **Configuration > Network > Interfaces > Ethernet > ETH n:**

VRF

Associates the interface with a particular Virtual Routing and Forwarding (VRF) instance.

VRFexport

Adds routes from this VRF to interfaces on other VRFs.

Configure VRF for GRE tunnel interfaces

For GRE tunnel interfaces, these parameters are on **Configuration > Network > Interfaces > GRE> Tunnel n:**

VRF

Associates the interface with a particular VRF.

Destination VRF

Associates the interface with a particular destination VRF.

 **Command line**

Command	Instance	Parameter	Values	Equivalent web parameter
eth	n	vrf	integer	VRF
eth	n	vrfexport	integer	VRfexport
tun	n	vrf	integer	VRF
tun	n	vrfdest	integer	Destination VRF
ppp	n	vrf	integer	VRF
ppp	n	vrfexport	integer	VRfexport

Configuring Virtual Private Networking (VPN)

Virtual Private Networks (VPNs)	468
Configure Internet Protocol security (IPsec)	469
Configure Point-to-Point Tunneling Protocol (PPTP)	524
Configure OpenVPN	526

Virtual Private Networks (VPNs)

Virtual Private Networks (VPNs) securely connect two private networks together so that devices may connect from one network to the other network using secure channels. VPN uses IP Security (IPSec) technology to protect the transferring of data over the Internet. This section covers concepts and settings for configuring VPNs.

VPNs (Virtual Private Networks) are networks that use the IPSec protocols to provide one or more secure routes, or tunnels, between endpoints. Users are issued either a shared secret key or public/private key pair that is associated with their identity. When a message is sent from one user to another, it is automatically signed with the user's key. The receiver uses the secret key or the sender's public key to decrypt the message. The router uses these keys during IKE exchanges along with other information to create session keys that only apply for the lifetime of that IKE exchange.

Configure Internet Protocol security (IPsec)

IPsec (Internet Protocol security) is a group of protocols and standards for protecting data during transmission over the internet (which is inherently insecure). Various levels of support for IPsec can be provided on the router depending on the model. The web pages located under the **Configuration > Network > Virtual Private Networking (VPN) > IPsec** set the various parameters and options that are available. You should note however that this is a complex area and you should have a good understanding of user authentication and data encryption techniques before you commence. For further information refer to the IPsec and VPNs section in this manual. Also check the Technical Notes section of the Digi International web site at www.digi.com for the latest IPsec application notes.

The first stage in establishing a secure link between two endpoints on an IP network is for those two points to securely exchange a little information about each other. This enables the endpoint responding to the request to decide whether it wishes to enter a secure dialogue with the endpoint requesting it. To achieve this, the two endpoints commonly identify themselves and verify the identity of the other party. They must do this in a secure manner so that the process cannot be listened in to by any third party. The IKE protocol performs this checking and if everything matches up it creates a Security Association (SA) between the two endpoints, normally one for data being sent **to** the remote end and one for data being received **from** it.

Once this initial association exists the two devices can talk securely about and exchange information on what kind of security protocols they would like to use to establish a secure data link, such as what sort of encryption and/or authentication they can use and what sources/destinations they will accept. When this second stage is complete (and provided that both systems have agreed what they will do), IPsec will have set up its own Security Associations which it uses to test incoming and outgoing data packets for eligibility and perform security operations on before passing them down or relaying them from the tunnel.

About Internet Protocol Security (IPSec)

An inherent problem with the TCP protocol for carrying data over the vast majority of LANs and the Internet is that it provides virtually no security features. This lack of security, and publicity about hackers and viruses, prevent many people from even considering using the Internet for any sensitive business application. IPSec provides a remedy for these weaknesses adding a comprehensive security layer to protect data carried over IP links.

IPSec (Internet Protocol Security) is a framework for a series of IETF standards designed to authenticate users and data, and to secure data by encrypting it during transit.

Benefits of IPSec

IPSec provides confidentiality, integrity, and authentication in the transport of data across inherently insecure channels.

When properly configured, IPSec provides a highly secure virtual channel across cheap, globally available networks such as the Internet, or creates a “network within a network” for applications such as passing confidential information between two users across a private network.

Protocols defined within IPSec

The protocols defined within IPSec include:

- **IKE:** Internet Key Exchange protocol
- **ISAKMP:** Internet Security Association and Key Management Protocol
- **AH:** Authentication Header protocol
- **ESP:** Encapsulating Security Payload protocol
- **HMAC:** Hash Message Authentication Code
- **MD5:** Message Digest 5
- **SHA-1:** Security Hash Algorithm

Cryptographic (encryption) techniques include:

- **DES:** Data Encryption Standard
- **3DES:** Triple DES
- **AES:** Advanced Encryption Standard (also known as Rijndael)

Two key protocols within the framework are AH and ESP. AH authenticates users, and ESP applies cryptographic protection. The combination of these techniques is designed to ensure the integrity and confidentiality of the data transmission. Put simply, IPSec is about ensuring that:

- Only authorized users can access a service.
- No one else can see what data passes between one point and another.

IPsec operation modes

There are two modes of operation for IPSec, transport mode and tunnel mode.

- In transport mode, only the payload (such as the data content), of the message is encrypted.
- In tunnel mode, the payload and the header and routing information are all encrypted thereby providing a higher degree of protection.

Data Encryption Methods in IPsec

There are several different algorithms available for use in securing data whilst in transit over IP links. Each encryption technique has its own strengths and weaknesses and this is really, a personal selection made with regard to the sensitivity of the data you are trying to protect. Some general statements may be made about the relative merits but users should satisfy themselves as to suitability for any particular purpose.

DES (64-bit key)

The banking and financial world tends to use this well-known and established protocol. It is relatively processor-intensive; to run efficiently at high data rates, a powerful processor is required. It is generally considered very difficult for casual hackers to attack, but may be susceptible to determined attack by well-equipped and knowledgeable parties.

3-DES (192-bit key)

Again, this is a well-established and accepted protocol but as it involves encrypting the data three times using DES with a different key each time, it has a very high processor overhead. This also renders it almost impossible for casual hackers to attack and very difficult to break in any meaningful time frame, even for well-equipped and knowledgeable parties.

AES (128-bit key)

Also known as Rijndael encryption, AES is a standard adopted by many USA and European organizations for sensitive applications. It has a relatively low processor overhead compared to DES and it is therefore possible to encrypt at higher data rates. As with 3-DES, it is almost impossible for casual hackers to attack and is very difficult to break in any meaningful time frame, even for well-equipped and knowledgeable parties.

To put these into perspective, common encryption programs that are considered “secure” (such as PGP) and on-line credit authorization services (such as Web-based credit card ordering) generally use 128-bit encryption.

Note Data rates are the maximum that could be achieved, but may be lower if other applications are running at the same time or using small IP packet sizes.

Configure IPsec tunnels

Once the IKE parameters have been set-up, the next stage is to define the characteristics of the IPsec tunnels, or encrypted routes. This includes items such as what source and destination addresses will be connected by the tunnel and what type of encryption and authentication procedures will be applied to the packets being tunneled. For obvious reasons it is essential that parameters such as encryption and authentication are the same at each end of the tunnel. If they are not, then the two systems cannot agree on which set of rules or policy to adopt for the IPsec tunnel, and communication cannot occur.

Web

1. Go to **Configuration > Network > Virtual Private Networking > IPsec > IPsec Tunnels > IPsec n.**

Virtual Private Networking (VPN)

IPsec

IPsec Tunnels

IPsec 0

Description:

The IP address or hostname of the remote unit

Use as a backup unit

<p>Local LAN</p> <p><input checked="" type="radio"/> Use these settings for the local LAN</p> <p>IP Address: <input type="text"/></p> <p>Mask: <input type="text"/></p> <p><input type="radio"/> Use interface <input type="text"/> <input type="text"/></p>	<p>Remote LAN</p> <p><input checked="" type="radio"/> Use these settings for the remote LAN</p> <p>IP Address: <input type="text"/></p> <p>Mask: <input type="text"/></p> <p><input type="radio"/> Remote Subnet ID: <input type="text"/></p>
---	--

Use the following security on this tunnel

Off
 Preshared Keys
 XAUTH Init Preshared Keys
 RSA Signatures
 XAUTH Init RSA

Our ID:

Our ID type IKE ID FQDN User FQDN IPv4 Address

Remote ID:

Use encryption on this tunnel

Use authentication on this tunnel

Use Diffie Hellman group

Use IKE to negotiate this tunnel

Use IKE configuration:

Bring this tunnel up

All the time
 Whenever a route to the destination is available
 On demand

If the tunnel is down and a packet is ready to be sent

Bring this tunnel down if it is idle for hrs mins secs

Renew the tunnel after

hrs mins secs

KBytes of traffic

Tunnel Negotiation

Advanced

2. Configure basic IPsec tunnel parameters:

Description

A name for IPsec tunnel, to make it easier to identify the tunnel.

The IP address or hostname of the remote unit

The IP address or hostname of the remote IPsec peer that a VPN will be initiated to.

Use a.b.c.d as a backup unit

The IP address or hostname of a backup peer. If the router cannot open a connection to the primary peer, it uses this configuration. The backup peer device must have an identical IPsec tunnel configuration as the primary peer.

Local LAN**Use these settings for the local LAN**

The local LAN subnet settings on the IPsec tunnel.

IP Address

Use this IP address for the local LAN subnet. This is usually the IP address of the router's Ethernet interface or that of a specific device on the local subnet (such as a PC running a client or host application).

Mask

Use this IP mask for the local LAN subnet. The mask sets the range of IP addresses that will be allowed to use the IPsec tunnel.

Use interface x,y

Use the IP address and mask of the specified interface.

Remote LAN**Use these settings for the remote LAN**

These define the remote LAN subnet settings on the IPsec tunnel.

IP Address

Use this IP address for the remote LAN subnet. This is usually the IP address of the peer's Ethernet interface or that of a specific device on the local subnet (such as a PC running a client or host application).

Mask

Use this IP mask for the remote LAN subnet. The mask sets the range of IP addresses that will be allowed to use the IPsec tunnel.

Remote Subnet ID

L2TP/IPsec VPNs normally use this setting. When the router is in server mode and negotiating IPsec from behind a NAT box, this parameter should be configured to the ID sent by the remote Windows client (this is usually the computer name).

Use the following security on this tunnel

The security identities on the IPsec tunnel.

Security type	Description
Preshared Keys	Requires that both IPsec peers share a secret key, or password, that can be matched by and verified by both peers. To configure the PSK, a user will need configuring that matches the inbound ID of the remote peer and the PSK is configured using the password parameter. This is done via Configuration > Security > Users . The User configuration serves a dual purpose, in that it may contain entries for normal login access (such as HTTP, FTP or Telnet), and entries for IPsec tunnels.
XAUTH Init Preshared Keys	Used when the remote peer is a Cisco device using XAUTH and PSK authentication.
RSA Signatures	Select this option when the IPsec authentication will use X.509 certificates.
XAUTH Init RSA	Used when the remote peer is a Cisco device using XAUTH and X.509 certificates for authentication.

Our ID

When Aggressive mode is **On**, this parameter is a string of up to 20 characters. It is sent to the remote peer to identify the initiator (such as the router). You can use the variable **%s** on this parameter, which causes the router's serial number to be sent. You can prefix this value with other text if required. When using certificates, configure this parameter with the **Altname** field in a valid certificate held on the router.

Our ID type

Defines how the remote peer is to process the **Our ID** configuration.

ID type	Description
IKE ID	The Our ID parameter is a simple key ID (such as vpnclient1).
FQDN	The Our ID parameter is a Fully Qualified Domain Name (such as vpnclient1.anycompany.com)
User FQDN	The Our ID parameter is a Fully Qualified Domain Name with a user element (such as joe.bloggs@anycompany.com)
IPv4 Address	An IPv4 Address in dotted decimal notation.

Remote ID

When Aggressive mode is **On**, this parameter is a string of up to 20 characters that identifies the remote peer. This setting should use the same text as the **Our ID** parameter in the remote peer's configuration. When Aggressive mode is **Off**, this parameter must be the IP address of the remote peer.

RSA Key File

Overrides the private key filename in the IKE configuration. Use only when the authentication stage of the IKE negotiation uses RSA Signatures (Certificates).

Use enc encryption on this tunnel

The ESP encryption protocol to use with this IPsec tunnel. The options are:

- **None**
- **Null**
- **DES**
- **3DES**
- **AES (128 bit keys)**
- **AES (192 bit keys)**
- **AES (256 bit keys)**

If the dropdown options only display **None** and **Null**, the router requires encryption enabling. See your Digi sales contact regarding enabling encryption.

Use auth authentication on this tunnel

The ESP authentication algorithm to use with this IPsec tunnel. The options are:

- **None**
- **MD5**
- **SHA1**

Use Diffie Hellman group

The Diffie Hellman (DH) group to use when negotiating new IPsec SAs. If enabled, the IPsec SA keys cannot be predicted from any of the previous keys generated. The options are **No PFS**, **1**, **2**, or **3**. The larger values result in stronger keys, but they take longer to generate.

Use IKE n to negotiate this tunnel

The IKE version to use to negotiate this IPsec tunnel.

Use IKE configuration

The IKE configuration instance to use with this Eroute when the router is configured as an Initiator.

Bring this tunnel up

Controls how the IPsec tunnel is brought up. The options are:

- **All the time**
- **Whenever a route to the destination is available**
- **On demand**

If the tunnel is down and a packet is ready to be sent

Defines the action that is performed when the IPsec tunnel is down and a packet needs to be sent. The options are:

- **Bring the tunnel up**
- **Drop the packet**
- **Send the packet without encryption and authentication**

Bring this tunnel down if it is idle for h hrs m mins s secs

Used when the IPsec tunnel is configured to come up on demand and defines how long the IPsec tunnel should remain up if there is no traffic is being sent on the tunnel.

Renew the tunnel after

Defines the constraints of when the IPsec tunnel SA has to be renewed.

h hrs m mins s secs

Renew the IPsec SA after the specified amount of time.

n units of traffic

Renew the IPsec SA after the specified amount of traffic has been passed over the tunnel. The traffic units can be specified as Kbytes, Mbytes or Gbytes. A value of **0** disables this parameter. SAs will expire and be renewed based on time, rather than amount of traffic.

3. Click **Tunnel Negotiation** and configure IPsec tunnel negotiation parameters:

▼ Tunnel Negotiation

Enable IKE tracing

Negotiate a different IP address and Mask

IP Address

Mask

Virtual IP Request Off ON with NAT ON without NAT (Remote crypto map) ON without NAT (Remote VTI)

XAuth ID:

Enable IKE tracing

Enables the router to write IKE negotiation information in the analyser trace.

Negotiate a different IP address and Mask

Configures the IPsec tunnel to negotiate a different local LAN IP address and mask. You can then use the firewall to translate the source addresses of the packets to a value that lies within the negotiated range. This allows a packet to match more than one IPsec tunnel, but use a different source address (from the peer’s perspective) depending on which IPsec tunnel is in use.

IP Address

The alternative IP address to negotiate.

Mask

The alternative IP mask to negotiate.

Negotiate a virtual IP address using MODECFG

Used when the remote peer is a Cisco device using MODECFG to assign a specific IP address to this router during SA setup negotiations. This is commonly seen in Remote Access (RA) type VPNs and EasyVPN solutions.

XAuth ID

Extended Authentication ID for use with Cisco XAUTH.

4. Click **Advanced** and configure advanced IPsec tunnel parameters as needed:

Advanced

IPsec mode Transport Tunnel

Use AH authentication on this tunnel

Use compression on this tunnel

Delete SAs when this tunnel is down

Replay detection window

Delete SAs when Ethernet is not a VRRP master

Go out of service if automatic establishment fails

Disconnect the configured interface after consecutive auto-negotiation failures

This tunnel can only use

Link tunnel with interface

Inhibit this IPsec tunnel when IPsec tunnels are up

Inhibit this IPsec tunnel unless IPsec tunnel is up

IKE negotiation source IP address is taken from the

Interface

Secondary IP address

Interface

Tunnel this IPsec tunnel inside another tunnel

NAT-Traversal Keepalive timer seconds

Allow IP protocol(s) in this tunnel

IP packets with ToS values must use this tunnel

Only tunnel IP packets with

local TCP/UDP port

remote TCP/UDP port

Insert remote subnet into routing table with metric

IPsec mode

Selects the IPsec encapsulation type to use on the IPsec tunnel. In Tunnel mode, the entire IP packet (header and payload) is encrypted. In Transport mode, only the IP payload is encrypted.

Use algorithm AH authentication on this tunnel

The AH authentication algorithm to use with this IPsec tunnel. The options are:

- **None**
- **MD5**
- **SHA1**

Use algorithm compression on this tunnel

The compression algorithm to use with this IPsec tunnel. The options are:

- **None**
- **DEFLATE**

Delete SAs when this tunnel is down

When selected, all SAs associated with the IPsec tunnel are deleted when the tunnel goes out of service.

Replay detection window

The size of the replay detection window. When set to **0** (default), replay detection is disabled. Maximum replay window size is **32**.

Delete SAs when router is not a VRRP master

When selected, at least one Ethernet interface must be set as VRRP Master before the router can create SAs. If the router switches away from VRRP Master state, the SAs will be deleted. When the router switches back to VRRP Master state, the SAs will be created automatically.

Go out of service if automatic establishment fails

The router will take the IPsec tunnel out of service if the automatic establishment fails rather than continually retrying.

Disconnect the configured interface after n consecutive auto-negotiation failures

The router will take the IPsec tunnel out of service if the auto-negotiation fails for the specified consecutive number of times rather than continually retrying.

This tunnel can only use apn

When enabled, this parameter allows you to choose between using the main APN or the backup APN, as defined in the **Configuration > Network > Serial > W-WAN Port** page.

Link tunnel with interface with x,y

When enabled, this parameter can be set so that the IPsec tunnel will only match packets using the specified interface. When this parameter is enabled, the route will take outgoing packets going through this IPsec tunnel and recheck to see if the resultant packet also goes through a tunnel.

If the inner tunnel is an IPsec tunnel (such as needs IKE), you can get the inner IKE to use the correct source address (matching the outer tunnel selectors) by enabling the Use secondary IP address parameter and the inner IKE will use the IP address configured in the Secondary IP address parameter on the **Configuration > Network > Advanced Network Settings** page.

Inhibit this IPsec tunnel when IPsec tunnels n are up

A list of IPsec tunnels that can inhibit using this IPsec tunnel as long as they are up. If this IPsec tunnel has been allowed to come up, and the IPsec tunnel that inhibits it comes back up, this IPsec is taken down and any SAs that may have existed are removed. As soon as an inhibiting

IPsec tunnel goes down, the router will check to see if the inhibited IPsec tunnel can now create SAs.

Inhibit this IPsec tunnel unless IPsec tunnel n is up

This IPsec tunnel will be inhibited unless specified IPsec tunnel is also up.

IKE negotiation source IP address is taken from the

Defines which IP address IKE uses as the source IP address during the negotiation.

Interface

Use the IP address of the interface over which the IKE packets will be transmitted.

Secondary IP address

Use the IP address configured in the Secondary IP address parameter on the **Configuration > Network > Advanced Network Settings** page.

Interface x,y

Use the IP address of the specified interface.

Tunnel this IPsec tunnel inside another IPsec tunnel

It is possible to tunnel packets from an IPsec tunnel within a second (or more) tunnel. When this parameter is enabled.

NAT-Traversal Keepalive timer s seconds

Sets the interval period, in seconds, that the router will use to send regular packets to a NAT device in order to prevent the NAT table entry from expiring.

Allow protocol IP protocol(s) in this tunnel

This restricts the type of IP packets that will be tunneled through the IPsec tunnel. The options are:

- All
- TCP
- UDP
- GRE

IP packets with ToS values n must use this tunnel

Packets with matching ToS fields will only be tunneled through this IPsec tunnel and no others. The usual traffic selector matching still takes place as normal. Packets that don't have matching ToS values will get tunneled as normal. Enter the ToS values as a comma-separated list, such as **2,4**.

Only tunnel IP packets with

Restricts the IP packets that will be tunneled to those with matching TCP/UDP port numbers.

local TCP/UDP port n

Allow IP packets with matching source TCP/UDP ports to be tunneled.

remote TCP/UDP port n

Allow IP packets with matching destination TCP/UDP ports to be tunneled.

local TCP/UDP port in the range of n1 to n2

Allow IP packets with source TCP/UDP ports in the specified range to be tunneled. This is only available when IKEv2 is in use.

remote TCP/UDP port in the range of n1 to n2

Allow IP packets with destination TCP/UDP ports in the specified range to be tunneled. This is only available when IKEv2 is in use.

5. Click **Apply**.

**Command line****Set basic IPsec tunnel parameters**

Command	Instance	Parameter	Values	Equivalent web parameter
eroute	n	descr	String	Description
eroute	n	peerip	IP address or hostname	The IP address or hostname of the remote unit.
eroute	n	bakpeerip	IP address or hostname	Use n as a backup unit.
eroute	n	locip	IP address	IP Address (for Local LAN)
eroute	n	locmsk	IP Mask	IP Mask (for Local LAN)
eroute	n	locipifent	blank, ETH, PPP	Use interface x,y x=Interface type
eroute	n	locipifadd	Integer	Use interface x,y y =interface number
eroute	n	remip	IP address	IP Address (for Remote LAN).
eroute	n	remmsk	IP Mask	IP Mask (for Remote LAN).
eroute	n	remnetid	String	Remote Subnet ID.
eroute	n	authmeth	Off, Preshared, xauthinitpre, rsa, xauthinitrsa	Use the following security on this tunnel.
eroute	n	ourid	String	Our ID.
eroute	n	ouridtype	0=IKE ID 1=FQDN 2=User FQDN 3=IPv4 Address	Our ID type.
eroute	n	peerid	String	Remote ID.

Command	Instance	Parameter	Values	Equivalent web parameter
eroute	n	privkey	Filename	RSA Key File.
eroute	n	espcnc	off, null, des, 3des, aes	Use enc encryption on this tunnel.
eroute	n	enckeybits	128, 192, 256	Use enc encryption on this tunnel.
eroute	n	espauth	off, md5, sha1	Use auth authentication on this tunnel.
eroute	n	dhgroup	0, 1, 2, 3	Use Diffie Hellman group.
eroute	n	ikever	1, 2	Use IKE n to negotiate this tunnel.
eroute	n	ikecfg	0, 1	Use IKE configuration.
eroute	n	autosasa	0=On Demand 1=When a route to the destination is available 2=All the time	Bring this tunnel up.
eroute	n	nosa	drop, pass, try	If the tunnel is down and a packet is ready to be sent.
eroute	n	inact_to	Integer	Bring this tunnel down if it is idle for h hrs m mins s secs. This CLI value is entered in seconds only.
eroute	n	ltime	Integer	Renew the tunnel after h hrs m mins s secs. This CLI value is entered in seconds only.
eroute	n	lkbytes	Integer	Renew the tunnel after n units of traffic. This CLI value is entered in Kbytes only.

Configure IPsec tunnel negotiation parameters

Entity	Instance	Parameter	Values	Equivalent web parameter
eroute	n	debug	on, off	Enable IKE tracing
eroute	n	neglocip	IP Address	Negotiate a different IP address and Mask
eroute	n	neglocmsk	IP Mask	Negotiate a different IP address and Mask
eroute	n	vip	on, off	Negotiate a virtual IP address using MODECFG
eroute	n	xauthid	String	XAuth ID

Configure advanced IPsec tunnel parameters **Command line**

Command	Instance	Parameter	Values	Equivalent web parameter
eroute	n	mode	tunnel, transport	IPsec Mode.
eroute	n	ahauth	off, md5, sha1	Use a AH authentication on this tunnel.
eroute	n	ipcompalg	off, deflate	Use c compression on this tunnel.
eroute	n	oosdelsa	on, off	Delete SAs when this tunnel is down.
eroute	n	ifvrrpmaster	on, off	Delete SAs when router is not a VRRP master.
eroute	n	nosaoos	on, off	Go out of service if automatic establishment fails.
eroute	n	nosadeactcnt	Integer	Go out of service after n consecutive auto-negotiation failures.
eroute	n	check_apnbu	on, off	This tunnel can only use apn.
eroute	n	apnbu	0=Main APN 1=Backup APN	This tunnel can only use apn.
eroute	n	ifent	blank, ETH, PPP	Link tunnel with interface with x,y. x=Interface type
eroute	n	ifadd	Integer	Link tunnel with interface with x,y. y=Interface number
eroute	n	inhibitno	Comma-separated list of Integers	Inhibit this IPsec tunnel when IPsec tunnels n are up.
eroute	n	requireno	Integer	Inhibit this IPsec tunnel unless IPsec tunnel n is up.
eroute	n	usesecip	on, off	IKE negotiation source IP address is taken from the Secondary IP Address.
eroute	n	ipent	blank, ETH, PPP	IKE negotiation source IP address is taken from the Interface x,y. x=Interface type

Command	Instance	Parameter	Values	Equivalent web parameter
eroute	n	ipadd	Integer	IKE negotiation source IP address is taken from the Interface x,y. y=Interface number
eroute	n	intunnel	on, off	Tunnel this IPsec tunnel inside another IPsec tunnel.
eroute	n	natkaint	Integer	NAT-Traversal Keepalive timer s seconds.
eroute	n	proto	off, tcp, udp, gre	Allow protocol IP protocol(s) in this tunnel.
eroute	n	toslist	Comma-separated list of Integers	IP packets with ToS values n must use this tunnel.
eroute	n	locport	0-65535	Only tunnel IP packets with local TCP/UDP port.
eroute	n	remport	0-65535	Only tunnel IP packets with remote TCP/UDP port.
eroute	n	locfirstport	0-65535	Only tunnel IP packets with local TCP/UDP port in the range of n1 to n2.
eroute	n	loclastport	0-65535	Only tunnel IP packets with local TCP/UDP port in the range of n1 to n2.
eroute	n	remfirstport	0-65535	Only tunnel IP packets with remote TCP/UDP port in the range of n1 to n2.
eroute	n	remlastport	0-65535	Only tunnel IP packets with remote TCP/UDP port in the range of n1 to n2.

Set up IPsec tunnels for multiple users

For small numbers of users it is usual to set up an individual eroute for each user. However, to ease configuration where large numbers of users are required, you can use the * character as a wildcard to match multiple user IDs. For example, setting the **Peer ID** parameter to **Digi*** would match all remote units having an **Our ID** parameter starting with **Digi**, such as **Digi01**, **Digi02**, etc.

Example

To set up multiple users in this way, first set up the **Our ID** parameter on the host unit to a suitable name, such as **Host1**. Then set the **Peer ID** parameter to **Remote*** for example. In addition, an entry would be made in the user table with **Remote*** for the **Username** and a suitable **Password** value, such as **mysecret**.

Each of the remote units that required access to the host would then have to be configured with an **Our ID** parameter of **Remote01**, **Remote02**, etc., and each would have to have an entry in their user table for **User Host1** along with its password, such as the pre-shared key.

Parameter	Host Router	Remote Router1	Remote Router2	Remote Router1
Peer ID	Remote*	Host1	Host1	Host1
Our ID	Host1	Remote01	Remote02	Remote03
Username	Remote*	Host1	Host1	Host1
Password	mysecret	mysecret	mysecret	mysecret

Configure IPsec tunnel default action

Like a normal IP routing set-up, IPsec Tunnels have a default configuration that is applied if no specific tunnel can be found. This is useful when, for example, you want to have a number of remote users connect via a secure channel, for example, to access company financial information, but also still allow general remote access to other specific servers on your network or the Internet.

Web

1. Go to **Configuration > Network > Virtual Private Networking > IPsec Tunnels > IPsec Default Action**.

IPsec Default Action

When a packet is received which does not match any IPsec tunnel

- Pass the packet
- Drop the packet

When a packet is to be transmitted which does not match any IPsec tunnel

- Pass the packet
- Drop the packet

2. Configure the IPsec tunnel default action parameters:

When a packet is received which does not match any IPsec tunnel

How the router responds if a packet is received when there is no SA.

- **Drop the packet:** Routes only packets that match a specified IPsec tunnel and discards all other data. This has the effect of enforcing a secure connection to all devices behind the router.
- **Pass the packet:** Decrypts and authenticates all packets that match an IPsec tunnel, depending on the IPsec tunnel's configuration. Data that does not match is also allowed to pass.

When a packet is to be transmitted which does not match any IPsec tunnel

How the router will respond if a packet is transmitted when there is no SA.

- **Drop the packet:** Routes only packets that match a specified IPsec tunnel and discards all other data.
- **Pass the packet:** Decrypts and authenticates all packets that match an IPsec tunnel, depending on the IPsec tunnel's configuration. Data that does not match is also allowed to pass.

3. Click **Apply**.

**Command line**

Command	Instance	Parameter	Values	Equivalent web parameter
def_eroute	0	nosain	drop, pass	When a packet is received which does not match any IPsec tunnel.
def_eroute	0	nosaout	drop, pass	When a packet is to be transmitted which does not match any IPsec tunnel.

Configure IPsec groups

IPsec groups are supported on TransPort WR44v2 models only.

You can use IPsec groups when the router is terminating tunnels to a large number of remote devices, such as using the router as a VPN Concentrator. To keep the size of the configuration file in the router small and also to maintain ease of configuration, only the information for all tunnels is stored on the router. All other information that is site specific is stored in a MySQL database. This means the number of sites that can be configured is limited only by the SQL database size and performance. This will be literally millions of sites, depending upon the operating system and hardware of the MySQL PC. The number of sites that can be connected to concurrently are much smaller and limited by the model of the router.

- The router with the IPsec Group/MySQL configuration is the VPN Concentrator.
- The remote sites normally do not require an IPsec group configuration, as they normally need to connect to a single peer only, the VPN Concentrator.
- The VPN Concentrator normally need a single IPsec group configured only.
- The local and remote subnet parameters must be set up wide enough to encompass all the local and remote networks.
- The VPN Concentrator can act as an initiator and/or a responder. In situations where there are more remote sites than the router can support concurrent sessions, it is normally necessary for the VPN Concentrator and the remote sites to be both an initiator and a responder. This is so both the remote sites and the head-end can initiate the IPsec session when required.
- It is also important to configure the IPsec tunnels to time out on inactivity to free up sessions for other sites. In the case of the VPN Concentrator acting as an initiator, when it receives a packet that matches the main IPsec tunnel, if no Security Associations already exist, it looks up the required parameters in the database.
- The router then creates a dynamic IP tunnel containing all the settings from the base IPsec tunnel and all the information retrieved from the database.
- At this point, IKE creates the tunnel (IPsec security associations) as normal.
- The dynamic IPsec tunnel continues to exist until all the IPsec Security Associations are removed.
- When the maximum supported (or licensed) number of tunnels has been reached by the router, the oldest Dynamic IPsec tunnels (those not in use for the longest period of time) and their associated IPsec Security Associations are dropped, to allow new inbound VPNs to connect.

Logic flow for creating IPsec SAs

VPN Concentrator acting as initiator

The VPN Concentrator normally acts as an initiator when it receives an IP packet for routing with a source address matching the IPsec tunnel local subnet address & mask and a destination address matching the remote subnet address & mask, provided an IPsec SA does not already exist for this site.

1. If an IPsec group is configured to use the matching IPsec tunnel, the router uses a MySQL query to obtain the site specific information in order to create the SAs.

2. The VPN Concentrator creates a SELECT query using the destination IP address of the packet and the mask configured in the IPsec group configuration to determine the remote subnet address. This means that the remote subnet mask must be the same on all sites using the current IPsec group.
3. Once the site-specific information is retrieved, the router creates a dynamic IPsec Tunnel which is based upon the base IPsec tunnel configuration plus the site specific information from the MySQL database.
4. The router then uses the completed IPsec tunnel configuration and IKE to create the IPsec SAs.
5. For the pre-shared key, IKE uses the password returned from the MySQL database rather than doing a local look up in the user configuration.
6. Once created, the SAs are linked with the dynamic IPsec tunnel. Replacement SAs are created as the lifetimes start to get low and traffic is still flowing.
7. When all SAs to this remote router are removed, the dynamic IPsec tunnel is removed, allowing reuse of the IPsec tunnel to create tunnels to other remote sites.
8. When processing outgoing packets, dynamic IPsec Tunnels are searched before base IPsec tunnels. If a matching dynamic IPsec tunnel is found, the router uses that tunnel, and the base IPsec tunnel is only matched if no dynamic IPsec tunnel exists.
9. Once the dynamic IPsec tunnel is removed, further outgoing packets will match the base IPsec tunnel and the process is repeated.

VPN Concentrator acting as a responder to a session initiated from the remote site

1. When a remote site needs to create an IPsec SA with the VPN Concentrator it sends an IKE request to the VPN Concentrator.
2. The VPN Concentrator needs to be able to confirm that the remote device is authorized to create an IPsec tunnel. The remote site supplies its ID to the host during the IKE negotiations. The VPN Concentrator uses this ID in a search of the IPsec tunnels configured and dynamic IPsec tunnels to see if the supplied ID matches the configured Peer ID (**peerid**). If a match is found, the MYSQL database is queried to retrieve the information required to complete the negotiation (such as pre-shared key/password). If no matching base IPsec tunnel is found, router uses the local user configuration to locate the password, and a normally configured IPsec tunnel must also exist.
3. Once the information is retrieved from the MySQL database, IKE negotiations continue, and the created IPsec SAs will be associated with the dynamic IPsec tunnel.
4. As long as the dynamic IPsec tunnel exists, it behaves just like a normal IPsec tunnel. such as SAs being replaced/removed as required.
5. If errors are received from the MySQL database, or not enough fields are returned, the dynamic IPsec tunnel is removed, and IKE negotiations in progress are terminated.

6. There are a limited number of dynamic IPsec tunnels. If the number of free dynamic IPsec tunnel is less than **10** percent of the total number of dynamic IPsec tunnel, the router periodically removes the oldest dynamic IPsec tunnel. This is done to ensure that there will always be some free dynamic IPsec tunnel available for incoming connections from remote routers. To view the current dynamic tunnels that exist using the WEB server, browse to **Management > Connections > Virtual Private Networking (VPN) > IPsec**. The table indicates the base IPsec tunnel and the **Remote Peer ID** in the status display, to help identify which remote sites are currently connected.

Preliminary IP Tunnel configuration

The IPsec tunnel configuration **Configuration > Network > Virtual Private Networking (VPN) > IPsec > IPsec Tunnels > IPsec n** differs from a normal configuration in the following ways:

- **Peer IP/hostname:** Because the peer IP address to each peer is unknown and is retrieved from the database, this field is left empty.
- **Bakpeerip (CLI only):** Because the peer IP address to each peer is unknown and is retrieved from the database, this field is left empty.
- **Peer ID:** When the host Digi is acting as a responder during IKE negotiations, the router uses the ID supplied by the remote to decide whether or not the MySQL database should be interrogated. So that the router can make this decision, the remote router must supply an ID that matches the peerid configured into the IPsec tunnel. Wildcard matching is supported which means that the peerid may contain ***** and **?** characters. If only one IPsec tunnel is configured, the peerid field may contain a *****, indicating that all remote IDs result in a MySQL look up.
- **Local subnet IP address / Local subnet mask:** Configured as usual.
- **Remote subnet IP address / Remote subnet mask:** These fields should be configured in such a way that packets to ALL remote sites fall within the configured subnet. such as if there are two sites with remote subnets **192.168.0.0/24**, and **192.168.1.0/24** respectively, a valid configuration for the host would be **192.168.0.0/23** so that packets to both remote sites match.

All other fields should be configured as usual. It is possible to set up other IPsec groups linked with other IPsec tunnels. This would be done if there is a second group of remote sites that have a different set of local and remote subnets, or perhaps different encryption requirements. The only real requirement is that this second group uses peer IDs that do not match up with those in use by the first IPsec group.

IPsec Group configuration

This configuration holds information relating to the MySQL database, and the names of the fields where the information is held. This configuration also identifies which IPsec tunnels create dynamic IPsec tunnels.

Example MySQL schema

```
mysql> describe eroutes;
```

Field	Type	Null	Key	Default	Extra
peerip	varchar(20)	YES		NULL	
bakpeerip	varchar(20)	YES		NULL	
peerid	varchar(20)	NO	PRI		

password	varchar(20)	YES		NULL		
ourid	varchar(20)	YES		NULL		
remip	varchar(20)	YES	UNI	NULL		
remmsk	varchar(20)	YES		NULL		

7 rows in set (0.01 sec)

Configuration parameters

The IPsec group configuration parameters are as follows:

Web

- Go to **Configuration > Network > Virtual Private Networking (VPN) > IPsec > IPsec Groups > IPsec Group n**.

▼ IPsec Groups

▼ IPsec Group 0

Link this IPsec Group with IPsec Tunnel:

Remote mask to use for tunnels:

Database

MySQL Server IP Address or Hostname:

MySQL Server Port:

Username:

Password:

Confirm Password:

Database name:

Database table:

Database Table Field Names

These define the names of the fields in which the following data is stored.

Remote subnet IP:

Remote subnet Mask:

Peer IP Address:

Backup Peer IP Address:

Peer ID:

Our ID:

Password:

Apply

- Configure IPsec group parameters as needed.

Link this IPsec group with IPsec Tunnel

The base IPsec tunnel number. This parameter allows the router to see that an IPsec tunnel should use the group configuration to retrieve dynamic information from the database.

Remote mask to use for tunnels

Used in the SQL SELECT query in conjunction with the destination IP address of packets to be tunneled from the host to the remote peer to identify the correct record to select from the MySQL database.

MySQL Server IP Address or Hostname

The IP address or hostname of the MySQL Server.

MySQL Server Port

The port that the MySQL Server is listening on.

Username

The username to use when logging into the MySQL Server.

Password / Confirm Password

The password to use when logging into the MySQL Server.

Database name

The name of the database to connect to.

Database table

The name of the table when the remote site information is stored.

Remote subnet IP

The name of the field in the table where the 'remip' data is stored.

Remote subnet Mask

The name of the field in the table where the **remmsk** data is stored.

Peer IP Address

The name of the field in the table where the **peerip** data is stored.

Backup Peer IP Address

The name of the field in the table where the **bakpeerip** data is stored.

Peer ID

The name of the field in the table where the **peerid** data is stored.

Our ID

The name of the field in the table where the **ourid** data is stored.

Password

The name of the field in the table where the password to use in IKE negotiations is stored.

Note The default MySQL field names match the matching IPsec tunnel configuration parameter name. The default field name for the **password** field is **password**.

3. Click **Apply**.

Command line

Command	Instance	Parameter	Values	Equivalent web parameter
egroup	n	eroute	Integer	Link this IPsec group with IPsec Tunnel
egroup	n	remmsk	IP Mask	Remote mask to use for tunnels
egroup	n	dbhost	IP Address or Hostname	MySQL Server IP Address or Hostname
egroup	n	dbport	0-65535	MySQL Server Port
egroup	n	dbuser	String	Username
egroup	n	dbpwd	String	Password / Confirm Password
egroup	n	dbname	String	Database name
egroup	n	dbtable	String	Database table
egroup	n	fremip	String	Remote subnet IP
egroup	n	fremmsk	String	Remote subnet Mask
egroup	n	fpeerip	String	Peer IP Address
egroup	n	fbakpeerip	IP Address	Backup Peer IP Address
egroup	n	fpeerid	String	Peer ID
egroup	n	fourid	String	Our ID
egroup	n	fpwd	String	Password

Use IPsec Egroups with an SQL database

When the router uses IPsec Egroups with a SQL database for dynamic Eroute configuration, several commands can help you configure and troubleshoot the router.

Local Database commands

As well as using an external SQL database, the router can cache the SQL table entries it learns from the SQL server in RAM so if the SQL server goes offline for any reason, the database entries are still available to renew existing IPsec SAs.

To configure the caching options the command is:

```
sql 0 <parameter> <value>.
```

The following parameters are available to configure the caching of database entries:

**Command line****dbsrvmem <n>**

The amount of memory (RAM) the MySQL server cache should use. **<n>** is specified in multiples of 1k, such as **10Mb=10240**.

To calculate the amount of memory to specify in this parameter:

- Note the size of the database file (**.csv**) that will be loaded into the router memory.
- Double this value and add **100Kb**, for example, if the **.csv** file is **200Kb**, this would make a value of **500Kb** for the memory allocation. Use this command: **sql 0 dbsrvmem 500**.
- Load the database file into memory and check the memory allocated and free using the **smem** command. This will show the memory allocated and left available. Increase the memory in the **dbsrvmem** command if required.

dbfile <name>

The name of the **.csv** file that the router will use to store the table definitions (1st line) and data records. This file is stored in flash. The router uses it to populate the database stored in RAM on power-up or when a new file matching this name has just been stored. The dbfile can be populated with records or be empty except for the definitions line. The dbfile stored in RAM will be populated from both the dbfile stored in flash and (if configured) via caching items learned from the main SQL server. The dbfile in flash can then be updated from the dbfile in RAM and saved.

dbname <name>

The name of the backup database in case the main database goes offline. This name must match the database name in use on the SQL server.

learn <off|on>

When enabled, the router will cache entries learned via the main SQL database in a file stored in RAM. You can use this file as a backup if the main SQL database going offline. To use learning mode, at least one column in the **.csv** dbfile must be marked as a unique key, with the **U** prefix.

For example, remip is marked as the unique key:

```
peerip[IP],bakpeerid[IP],peerid[K20],password[20],ourid[20],remip
[UKIP],remmsk[IP]
```

Learning mode: saving entries

When using learning mode, the dynamic backup database is stored in RAM. This database is lost if the router is power-cycled. You can save the database in RAM to flash to over-write the dbfile with the one in RAM that includes the learned entries or it can be saved to a new file.

To save the dbfile to flash from RAM, use the following command:

```
sqlsave 0 <filename>
```

Where **<filename>** is the name of the destination file.

For example, to save the learned database entries to a file called **backup.csv**:

```
sqlsave 0 backup.csv
```

If there are no learned entries, this command will not create a file. To view the number to learned entries, use the command **sql 0 ?**, and in the output, see the section headed **Learning info**:

```

Learning info.
items learned:0
matched retrievals:0
OK

```

Configure a TransPort to use a backup database

Once the router has been configured to run a SQL csv database locally, you can use this backup csv database if the main SQL database goes offline. Required configuration parameters are:

1. Configure the IP address of the SQL server to use.

```
egroup 0 dbhost "192.168.0.50"
```

2. Configure the IP address of the SQL server that will have a backup database. If a socket connection fails to this IP address, the router will use the backup IP address.

```
ipbu 0 IPAddr "192.168.0.50"
```

3. Configure the backup database IP address; that is, the loopback address of the router or an alternative SQL server, this example shows the loopback IP address of the router.

```
ipbu 0 BUIPAddr "127.0.0.1"
```

4. Set the amount of time in seconds that the connection to the main SQL server will be retried.

```
ipbu 0 retrysec 30
```

5. Set the router to use the backup IP address if the main database is unavailable.

```
ipbu 0 donext ON
```

For example, to configure and use a local backup database when the main SQL database at **192.168.0.50** is offline, the configuration may look similar to this:

```

egroup 0 dbhost "192.168.0.50"
sql 0 dbsrvmem 200
sql 0 dbfile "saradb.csv"
sql 0 dbname "sarvpns"
sql 0 learn ON
sqlsave 0 backup.csv
ipbu 0 IPAddr "192.168.0.50"
ipbu 0 BUIPAddr "127.0.0.1"
ipbu 0 retrysec 30
ipbu 0 donext ON

```

smem command: Display memory information

```
smem
```

Displays the amount of memory allocated, in use and available for use by the MySQL server on the router.

Transact SQL commands

To query a SQL database manually using transact SQL statements, use the following commands:

Connect to the SQL server and database

```
sqlcon <host> <user> <pwd> <database>
```

For example:

```
sqlcon 192.168.0.50 sqluser sqlpass eroute-db
```

Issue transact SQL statements

```
sqldo <"cmd">
```

For example:

```
sqldo "select * from site where subnet='10.110.100.0' limit 3"
```

Limit the sqldo command to only act on specified fields

```
sqlfields "<field1> <field2> <field3>"
```

After issuing the **sqlfields** command, all further **sqldo** commands will apply to these fields only.

For example:

```
sqlfields "remmsk password peerip"
```

Close the SQL server connection correctly

```
sqlclose
```

Use the SQL “debug” command

If the database being queried is held locally on the router, you can precede these transact SQL commands with the SQL **debug** command to get extra feedback on any commands issued.

- To enable the SQL debug:

```
sql 0 debug_opts 3
```

- To view the debug data via the ASY 0 port:

```
debug 0
```

- To view the SQL debug data via Telnet:

```
debug t
```

- To disable the SQL debug:

```
>sql 0 debug_opts 0  
debug off
```

Configure Dead Peer Detection (DPD)

When Dead Peer Detection (DPD) is enabled on an IPsec tunnel, the router will send an IKE DPD request at regular intervals. If no response is received to the DPD request, the IPsec tunnel is considered as suspect and the requests are sent at a shorter interval until either the maximum number of outstanding requests allowed is reached or a response is received. If no response is received to the configured maximum requests, the IPsec tunnels are closed.

Note IKE DPD requests require that an IKE SA is present. If one is not present, the DPD request will fail.

To help ensure that an IKE SA exists with a lifetime at least as great as the IPsec lifetime, the router creates new IKE SAs whenever the IPsec SA lifetime exceeds the lifetime of an existing IKE SA and attempts to negotiate a lifetime for the IKE SA that is **60** seconds longer than the desired lifetime of the IPsec SA.

Web

1. Go to **Configuration > Network > Virtual Private Networking (VPN) > IPsec > Dead Peer Detection (DPD)**.

DPD can be enabled or disabled in each IKE configuration.

Mark the IPsec tunnel as suspect if there is no traffic for seconds

Send a DPD request on a healthy link every seconds

Send a DPD request on a suspect link every seconds

Close the IPsec tunnels after no response for DPD requests

2. Configure Dead Peer Detection parameters:

Mark the IPsec tunnel as suspect if there is no traffic for n seconds

The period of time of inactivity on a tunnel before it is deemed to be suspect, such as if there is no activity on a healthy link for the time period defined, then the tunnel is then deemed to be suspect.

Send a DPD request on a healthy link every n seconds

The interval at which DPD requests are sent on an IPsec tunnel that is deemed to be healthy. A healthy link is one with traffic.

Send a DPD request on a suspect link every n seconds

The interval at which DPD requests are sent on an IPsec tunnel that is deemed to be suspect. A suspect link is one where there has been no traffic for a specified period of time.

Close the IPsec tunnels after no response for n DPD requests

The maximum number of DPD requests that will be sent without receiving a response before the IPsec tunnels are closed.

3. Click **Apply**.

**Command line**

Command	Instance	Parameter	Values	Equivalent web parameter
dpd	0	inact	Integer	Mark the IPsec tunnel as suspect if there is no traffic for n seconds
dpd	0	okint	Integer	Send a DPD request on a healthy link every n seconds
dpd	0	failint	Integer	Send a DPD request on a suspect link every n seconds
dpd	0	maxfail	Integer	Close the IPsec tunnels after no response for n DPD requests

Configure Internet Key Exchange (IKE)

IKE Debug parameters

Web

- Go to **Configuration > Network > Virtual Private Networking (VPN) > IPsec > IKE**. The **Configuration > Network > Virtual Private Networking (VPN) > IPsec > IKE** page displays configuration pages for Internet Key Exchange (IKE) instances **IKE 0** and **IKE 1**, with a separate page for IKE Responder. The **IKE 0** instance can serve as an IKE initiator or as an IKE responder, while IKE 1 can serve as an initiator. Use the **IKE 0** and **IKE 1** pages to set up the **IKE 0** and **IKE 1** initiator parameters as required. The **IKE Responder** page configures the responder parameters for **IKE 0**.

IKE

▼ **IKE Debug**

Enable IKE Debug

 Debug Level: **Low** ▼

 Debug IP Address Filter:

Forward debug to port

- Configure IKE parameters:

Enable IKE Debug

Enables IKE debugging to be displayed on the debug port.

Debug Level

Sets the level of IKE debugging. The options are:

- **Low**
- **Medium**
- **High**
- **Very High**

Debug IP Address Filter

Used to filter out IKE packets with particular source or destination IP addresses. The format of this parameter is a comma-separated list of IP addresses. For example, to exclude the capture of IKE traffic from IP hosts **10.1.2.3** and **10.2.2.2**, enter **10.1.2.3,10.2.2.2** for this parameter.

Conversely, you may wish to only capture traffic to and from particular IP hosts. To do this, use a tilde (~) symbol before the list of IP addresses. For example, to only capture packets to and from IP host **192.168.47.1**, enter **~192.168.47.1** for this parameter.

Forward debug to port

When enabled, the IKE debug is sent to debug serial port.

3. Click **Apply**.



Command line

Command	Instance	Parameter	Values	Equivalent web parameter
ike	0	deblevel	0=Off 1=Low 2=Medium 3=High 4=Very High	Debug Level
ike	0	ipaddfilt	Comma-separated list of IP addresses	Debug IP Address Filter
ike	0	debug	on, off	Forward debug to port

Configure IKE n parameters



Web

1. Go to **Configuration > Network > Virtual Private Networking (VPN) > IPsec > IKE n**.

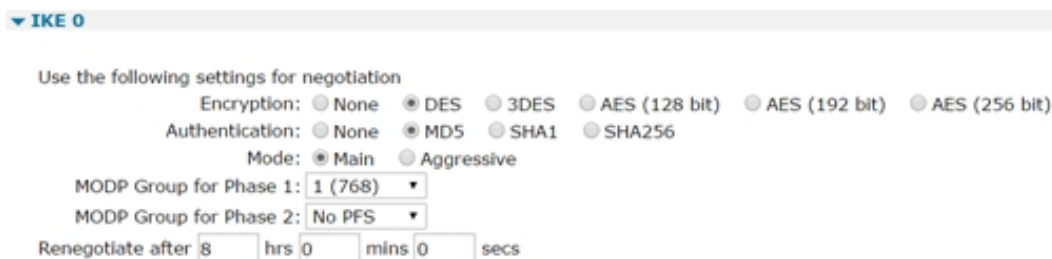

2. Configure the parameters for the IKE instance:

Use the following settings for negotiation

The IKE negotiation settings.

Encryption

The encryption algorithm. The options are:

- None
- DES
- 3DES
- AES (128 bit keys)
- AES (192 bit keys)
- AES (256 bit keys)

Authentication

The authentication algorithm. The options are:

- None
- MD5
- SHA1
- SHA256

Mode

The negotiation mode. The options are:

- Main
- Aggressive

Historically, setting up IPsec tunnel have involved fixed IP addresses. Today it is more common, particularly with Internet ISPs, to dynamically allocate the user a temporary IP address as part of the process of connecting to the Internet. In this case, the source IP address of the party trying to initiate the tunnel is variable and cannot be preconfigured.

In **Main** mode, such as non-aggressive, the source IP address must be known so that the router can use this mode over the Internet if the ISP provides a fixed IP address to the user, or you are using X.509 certificates.

Aggressive mode was developed to allow the host to identify a remote unit (initiator) from an ID string rather than from its IP address. This means that the router can use this mode over the Internet via an ISP that dynamically allocates IP addresses. It also has two other noticeable differences from main mode. Firstly, it uses fewer messages to complete the phase 1 exchange (3 compared to 5) and so will execute a little more quickly, particularly on networks with large turn-around delays such as GPRS. Secondly, as more information is sent unencrypted during the exchange, it is potentially less secure than a normal mode exchange.

Note When using certificates, you can use Main mode without knowing the remote unit's IP address when using certificates. This is because the ID of the remote unit (its public key) can be retrieved from the certificate file.

MODP Group for Phase 1

The key length in the IKE Diffie-Hellman exchange to **768** bits (group 1) or **1024** bits (group 2). Normally this option is set to **group 1**; this is sufficient for normal use. For particularly sensitive applications, you can improve security by selecting **group 2** to enable a 1024 bit key length. Note, however, that this will slow down the process of generating the phase 1 session keys (typically from 1-2 seconds for group 1), to 4-5 seconds.

MODP Group for Phase 2

The minimum width of the numeric field in the calculations for phase 2 of the security exchange. With **No PFS** (Perfect Forwarding Security) selected, the data transferred during phase 1 can be reused to generate the keys for the phase 2 SAs, hence speeding up connections. However, in doing this it is possible (though very unlikely), that if the phase 1 keys were compromised (such as discovered by a third party), the phase 2 keys might be more easily compromised. Enabling group **1 (768)** or **2 (1024)** or **3 (1536)**, IPsec MODP forces the key calculation for phase 2 to use new data that has no relationship to the phase 1 data and initiates a second Diffie-Hellman exchange. This provides an even greater level of security, but can take longer to complete.

Renegotiate after h hrs m mins s secs

How long the initial IKE Security Association stays in force. When this time expires, any attempt to send packets to the remote system results in IKE attempting to establish a new SA.

3. Click **Apply**.

 **Command line**

Command	Instance	Parameter	Values	Equivalent web parameter
ike	n	encalg	des, 3des, aes	Encryption
ike	n	keybits	0, 128, 192, 256	Encryption (AES Key length)
ike	n	authalg	md5, sha1	Authentication
ike	n	rauthalgs	sha256	PRF Algorithm
ike	n	aggressive	on, off	Mode
ike	n	ikegroup	1, 2, 5	MODP Group for Phase 1
ike	n	ipsecgroup	1, 2, 5	MODP Group for Phase 2
ike	n	ltime	1-28800	Renegotiate after h hrs m mins s secs This CLI value is entered in seconds only.

Configure advanced IKE parameters

 **Web**

1. Go to **Configuration > Network > Virtual Private Networking (VPN) > IPsec > IKE n > Advanced**.

Advanced

Retransmit a frame if no response after seconds

Stop IKE negotiation after retransmissions

Stop IKE negotiation if no packet received for seconds

Enable Dead Peer Detection

NAT Traversal Mode:

Send INITIAL-CONTACT notifications

Retain phase 1 SA after failed phase 2 negotiation

RSA private key file:

SA Removal Mode:

Delete SAs when invalid SPI notifications are received

2. Configure the advanced IKE parameters as needed:

Retransmit a frame if no response after n seconds

The amount of time, in seconds, that IKE will wait for a response from the remote unit before transmitting the negotiation frame.

Stop IKE negotiation after n retransmissions

The maximum number of times that IKE will retransmit a negotiation frame as part of the exchange before failing.

Stop IKE negotiation if no packet received for n seconds

The period of time, in seconds, after which the router will stop the IKE negotiation when no response to a negotiation packet has been received.

Enable Dead Peer Detection

Enables Dead Peer Detection. For more information, refer to the **Configuration > Network > IPsec > Dead Peer Detection (DPD)** page.

NAT Traversal Mode

Selects the NAT traversal mode for IKE/IPsec: **Auto**, **Disabled**, or **Force**.

When one end of an IPsec tunnel is behind a NAT box, some form of NAT traversal may be required before the IPsec tunnel can pass packets. Turning NAT Traversal on enables the IKE protocol to discover whether or not one or both ends of a tunnel is behind a NAT box, and implements a standard NAT traversal protocol if NAT is not being performed. The version of NAT traversal supported is that described in the IETF draft document [Negotiation of NAT-Traversal in the IKE](#).

Send INITIAL-CONTACT notifications

Enables INITIAL-CONTACT notifications to be sent.

Retain phase 1 SA after failed phase 2 negotiation

Normally IKE functionality is to remove the phase 1 SA if the phase 2 negotiation fails. Enabling this parameter will cause the router to retain the existing phase 1 SA and retry the phase 2 again.

RSA private key file

The name of a X.509 certificate file holding the router's private part of the public/private key pair in certificate exchanges. See [Use X.509 certificates with IPsec tunnels](#) section for further explanation.

SA Removal Mode

Determines how IPsec and IKE SAs are removed.

- **Normal** operation does not delete the IKE SA when all the IPsec SAs that were created by it are removed and does not remove IPsec SAs when the IKE SA that created them is deleted.
- **Remove IKE SA when last IPsec SA removed** deletes the IKE SA when all the IPsec SAs that it created to a particular peer are removed.
- **Remove IPsec SAs when IKE SA removed** deletes all IPsec SAs that have been created by the IKE SA that has been removed.

- **Both** removes IPsec SAs when their IKE SA is deleted, and deletes IKE SAs when their IPsec SAs are removed.

3. Click Apply.

Command line

Command	Instance	Parameter	Values	Equivalent web parameter
ike	n	retranint	0-255	Retransmit a frame if no response after n seconds
ike	n	retran	0-9	Stop IKE negotiation after n retransmissions
ike	n	inactto	0-255	Stop IKE negotiation if no packet received for n seconds
ike	n	dpd	on, off	Enable Dead Peer Detection
ike	n	natt	on, off	Enable NAT-Traversal
ike	n	initialcontact	on, off	Send INITIAL-CONTACT notifications
ike	n	keepph1	on, off	Retain phase 1 SA after failed phase 2 negotiation
ike	n	privsakey	Filename	RSA private key file
ike	n	delmode	0=Normal 1=Remove IKE SA when last IPsec SA removed 2=Remove IPsec SAs when IKE SA remove 3=Both	SA Removal Mode
ike	n	openswan	on, off	None. This enables support for Openswan IKE implementations.

IKE Responder command

Web

1. Go to **Configuration > Network > Virtual Private Networking (VPN) > IPsec > IKE > IKE Responder**.

The **IKE Responder** page displays the various parameters for **IKE 0** in Responder mode.

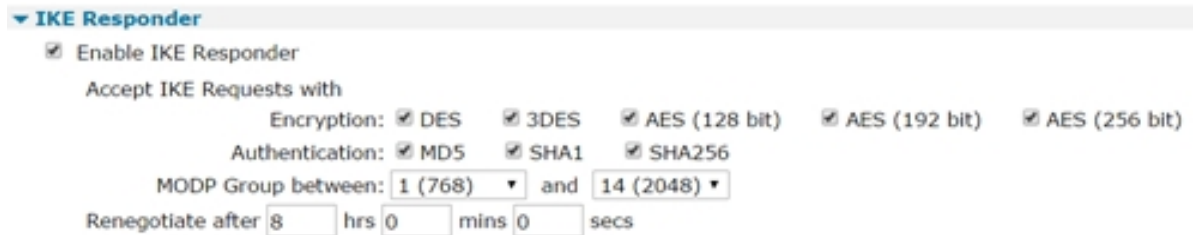

2. Configure IKE responder parameters as needed:

Enable IKE Responder

Allows the router to respond to incoming IKE requests.

Accept IKE Requests with

Defines the settings that the router will accept during the negotiation

Encryption

The acceptable encryption algorithms.

Authentication

The acceptable authentication algorithms.

MODP Group between x and y

The acceptable range for MODP group.

Renegotiate after h hrs m mins s secs

How long the initial IKE Security Association will stay in force. When the IKE Security Association expires, any attempt to send packets to the remote system will result in IKE attempting to establish a new SA.

3. Click **Apply**.

 **Command line**

Command	Instance	Parameter	Values	Equivalent web parameter
ike	0	noresp	on, off	Enable IKE Responder
ike	0	rencalgs	des, 3des, aes Multiple algorithms can specified in a comma-separated list	Encryption
ike	0	keybits	0, 128, 192, 256	Encryption (Minimum AES Key length)
ike	0	rauthalgs	md5, sha1 Multiple algorithms can specified in a comma-separated list	Authentication

Command	Instance	Parameter	Values	Equivalent web parameter
ike	0	rdhmingroup	1, 2, 5	MODP Group between x and y
ike	0	rdhmaxgroup	1, 2, 5	MODP Group between x and y
ike	0	ltime	1-28800	Renegotiate after h hrs m mins s secs This CLI value is entered in seconds only.

Configure advanced IKE Responder parameters

Web

- Go to **Configuration > Network > Virtual Private Networking (VPN) > IPsec > IKE > IKE Responder > Advanced**.

Advanced

Stop IKE negotiation if no packet received for seconds

Enable NAT-Traversal

Send INITIAL-CONTACT notifications

Send RESPONDER-LIFETIME notifications

Retain phase 1 SA after failed phase 2 negotiation

RSA private key file:

SA Removal Mode:

Delete SAs when invalid SPI notifications are received

- Configure advanced IKE responder parameters as needed:

Stop IKE negotiation if no packet received for n seconds

The period of time in seconds after which the router will stop the IKE negotiation when no response to a negotiation packet has been received.

Enable NAT-Traversal

Enables support for NAT Traversal within IKE/IPsec. When one end of an IPsec tunnel is behind a NAT box, some form of NAT traversal may be required before the IPsec tunnel can pass packets. Turning NAT Traversal on enables the IKE protocol to discover whether or not one or both ends of a tunnel is behind a NAT box, and implements a standard NAT traversal protocol if NAT is not being performed. The version of NAT traversal supported is that described in the IETF draft document *draft-ietf-ipsec-nat-t-ike-03.txt*.

Send INITIAL-CONTACT notifications

Enables **INITIAL-CONTACT** notifications to be sent.

Send RESPONDER-LIFETIME notifications

Enables **RESPONDER-LIFETIME** notifications sent to the initiator. If an initiator requests an IKE lifetime that is greater than the responder, a notification will be sent and the initiator should reduce its lifetime value accordingly.

Retain phase 1 SA after failed phase 2 negotiation

The name of a X.509 certificate file holding the router's private part of the public/private key pair in certificate exchanges. See [Use X.509 certificates with IPsec tunnels](#) for further explanation.

RSA private key file

The name of a X.509 certificate file holding the router's private part of the public/private key pair in certificate exchanges. See [Use X.509 certificates with IPsec tunnels](#) for further explanation.

SA Removal Mode

Determines how IPsec and IKE SAs are removed.

- **Normal** operation will not delete the IKE SA when all the IPsec SAs that were created by it are removed and will not remove IPsec SAs when the IKE SA that created them is deleted.
- **Remove IKE SA when last IPsec SA removed** deletes the IKE SA when all the IPsec SAs that it created to a particular peer are removed.
- **Remove IPsec SAs when IKE SA removed** deletes all IPsec SAs that have been created by the IKE SA that has been removed.
- **Both** removes IPsec SAs when their IKE SA is deleted, and delete IKE SAs when their IPsec SAs are removed.

Delete SAs when invalid SPI notifications are received

Deletes IKE SAs when the router receives invalid SPI notifications.

3. Click **Apply**.

**Command line**

Command	Instance	Parameter	Values	Equivalent web parameter
ike	0	inactto	0-255	Stop IKE negotiation if no packet received for n seconds
ike	0	natt	on, off	Enable NAT-Traversal
ike	0	initialcontact	on, off	Send INITIAL-CONTACT notifications
ike	0	respltime	on, off	Send RESPONDER-LIFETIME notifications
ike	0	keepph1	on, off	Retain phase 1 SA after failed phase 2 negotiation

Command	Instance	Parameter	Values	Equivalent web parameter
ike	0	privrsakey	Filename	RSA private key file
ike	0	delmode	0=Normal 1=Remove IKE SA when last IPsec SA removed 2=Remove IPsec SAs when IKE SA remove 3=Both	SA Removal Mode

MODECFG Static NAT mappings parameters

MODECFG is an extra stage built into IKE negotiations that fits between IKE phase 1 and IKE phase 2. It performs operations such as extended authentication (XAUTH) and requesting an IP address from the host. This IP address becomes the source address to use when sending packets through the tunnel from the remote to the host. This mode of operation, receiving one IP address from the remote host, is called client mode. Another mode, network mode, allows the router to send packets with a range of source addresses through the tunnel.

If the router receives packets from a local interface that need to be routed through the tunnel, it performs address translation so the source address matches the assigned IP address before encrypting using the negotiated SA. Some state information is retained so that packets coming in the opposite direction with matching addresses/ports can have their destination address set to the source address of the original packet, in the same way as standard NAT.

If the remote end of the tunnel can access units connected to the local interface, the unit that has been assigned the virtual IP address needs to have some static NAT entries set up. When a packet is received through the tunnel, the router first looks up existing NAT entries, followed by static NAT entries to determine whether the destination address/port should be modified, and forwards the packet to the new address. If a static NAT mapping is found, the router creates a dynamic NAT entry it uses for the duration of the connection. If no dynamic or stateful entry is found, the packet is directed to the local protocol handlers.

 **Web**

MODECFG Static NAT mappings

Map the following port ranges
(you may configure up to 20 mappings):

External Port	Forward to Internal IP Address	Forward to Internal Port	Range Port Count
No mappings have been configured			
<input type="text"/>	<input type="text"/>	<input type="text"/>	<input type="text"/>

External Port

The lowest destination port number to be matched if the packet is redirected.

Forward to Internal IP Address

An IP address to which packets containing the specified destination port number are redirected.

Forward to Internal Port

A port number to which packets containing the specified destination port number are redirected.

Port Range Count

The number of ports to be matched.

Add button

Adds the static NAT mapping to the IPsec tunnel configuration.

**Command line**

Command	Instance	Parameter	Values	Equivalent web parameter
tunsnat	n	minport	0-65535	External Port
tunsnat	n	maxport	0-65535	Port Range Count
tunsnat	n	ipaddr	IP Address	Forward to Internal IP Address
tunsnat	n	mapport	0-65535	Forward to Internal Port

Configure IKEv2

When IKE Version 2 is supported, you can specify whether to use IKEv1 or IKEv2 protocol to negotiate IKE SAs. The default is to use IKEv1. Routers that have been upgraded to support IKEv2 do not require any changes to their configuration to continue working with IKEv1.

Web

1. Go to **Configuration > Network > Virtual Private Networking (VPN) > IPsec > IKEv2 > IKEv2 n**.

The screenshot shows the configuration page for IKEv2. It includes a navigation tree with 'IKEv2' and 'IKEv2 0' expanded. The main content area is titled 'Use the following settings for negotiation' and contains several radio button options for Encryption, Authentication, and PRF Algorithm. A dropdown menu for 'MODP Group for Phase 1' is set to '1 (768)'. Below these are input fields for 'Renegotiate after' (8 hrs, 0 mins, 0 secs) and 'Rekey after' (0 hrs, 0 mins, 0 secs).

2. Configure the IKEv2 parameters:

Use the following settings for negotiation

The settings for the IKEv2 negotiation.

Encryption

The encryption algorithm. The options are **None**, **DES**, **3DES**, **AES (128 bit keys)**, **AES (192 bit keys)**, **AES (256 bit keys)**.

Authentication

The authentication algorithm. The options are **None**, **MD5**, **SHA1**, **SHA256**.

PRF Algorithm

The PRF (Pseudo Random Function) algorithm. The options are MD5 and SHA1.

MODP Group for Phase 1

Sets the key length for the IKE Diffie-Hellman exchange to **768** bits (**group 1**) or **1024** bits (**group 2**). Normally, this option is set to **group 1** and this is sufficient for normal use. For particularly sensitive applications, you can improve security by selecting **group 2** to enable a 1024 bit key length. Note however that this will slow down the process of generating the phase 1 session keys (typically from 1-2 seconds for **group 1**), to 4-5 seconds.

Renegotiate after h hrs m mins s secs

How long the initial IKEv2 Security Association will stay in force. When it expires any attempt to send packets to the remote system will result in IKE attempting to establish a new SA.

Rekey after h hrs m mins s secs

When the time left until expiry for this SA reaches the value specified by this parameter, the IKEv2 SA will be renegotiated, such as a new IKEv2 SA is negotiated and the old SA is removed. Any IPsec child SAs that were created are retained and become children of the new SA.

3. Click **Apply**.

 **Command line**

Command	Instance	Parameter	Values	Equivalent web parameter
ike2	n	iencalg	des, 3des, aes	Encryption
ike2	n	ienkeybits	128, 192, 256	Encryption (AES Key length)
ike2	n	iauthalg	md5, sha1, sha256	Authentication
ike	n	rauthalgs	sha256	PRF Algorithm
ike2	n	iprfalg	md5, sha1	PRF Algorithm
ike2	n	idhgroup	1, 2, 5	MODP Group for Phase 1
ike2	n	ltime	1-28800	Renegotiate after h hrs m mins s secs This CLI value is entered in seconds only.
ike2	n	rekeyltime	1-28800	Rekey after h hrs m mins s secs This CLI value is entered in seconds only.

Configure advanced IKEv2 n parameters

 **Web**

1. Go to **Configuration > Network > Virtual Private Networking (VPN) > IPsec > IKEv2 > IKEv2 n > Advanced**.

Advanced

Retransmit a frame if no response after seconds

Stop IKE negotiation after retransmissions

Stop IKE negotiation if no packet received for seconds

Enable Dead Peer Detection

Enable NAT-Traversal

NAT traversal keep-alive interval: seconds

RSA private key file:

2. Configure the IKEv2 advanced parameters as needed:

Retransmit a frame if no response after n seconds

The amount of time in seconds that IKEv2 will wait for a response from the remote unit before transmitting the negotiation frame.

Stop IKE negotiation after n retransmissions

The maximum number of times that IKEv2 will retransmit a negotiation frame as part of the exchange before failing.

Stop IKE negotiation if no packet received for n seconds

The period of time, in seconds, after which the router will stop the IKE v2 negotiation when no response to a negotiation packet has been received.

Enable NAT-Traversal

Enables support for NAT Traversal within IKE/IPsec. When one end of an IPsec tunnel is behind a NAT box, some form of NAT traversal may be required before the IPsec tunnel can pass packets. Turning NAT Traversal on enables the IKE protocol to discover whether or not one or both ends of a tunnel is behind a NAT box, and implements a standard NAT traversal protocol if NAT is not being performed. The version of NAT traversal supported is that described in the IETF draft document [draft-ietf-ipsec-nat-t-ike-03](#).

NAT traversal keep-alive interval n seconds

The interval, in seconds, in which the NAT Traversal keepalive packets are sent to a NAT device in order to prevent NAT table entry from expiring.

RSA private key file

The name of a X.509 certificate file holding the router's private part of the public/private key pair in certificate exchanges. See [Use X.509 certificates with IPsec tunnels](#) for further explanation.

3. Click **Apply**.

**Command line**

Command	Instance	Parameter	Values	Equivalent web parameter
ike2	n	retranint	0-255	Retransmit a frame if no response after n seconds
ike2	n	retran	0-9	Stop IKE negotiation after n retransmissions
ike2	n	inactto	0-255	Stop IKE negotiation if no packet received for n seconds
ike2	n	natt	on, off	Enable NAT-Traversal
ike2	n	natkaint	Integer	NAT traversal keep-alive interval n seconds
ike2	n	privsakey	Filename	RSA private key file

Configure IKEv2 Responder parameters**Web**

1. Go to **Configuration > Network > Virtual Private Networking (VPN) > IPsec > IKEv2 > IKEv2 Responder**.

The IKEv2 Responder page displays the various parameters for IKEv2 0 when in Responder mode.

▼ IKEv2 Responder

Enable IKEv2 Responder
 Accept IKEv2 Requests with

Encryption: DES 3DES AES (128 bit) AES (192 bit) AES (256 bit)

Authentication: MD5 SHA1 SHA256

PRF Algorithm: MD5 SHA1 SHA256

MODP Group between: and

Renegotiate after hrs mins secs

Rekey after hrs mins secs

▶ Advanced

- Configure the IKEv2 Responder parameters as needed:

Enable IKEv2 Responder

Allows the router to respond to incoming IKE requests.

Accept IKEv2 Requests with

The settings that the router will accept during the negotiation

Encryption

The acceptable encryption algorithms.

Authentication

The acceptable authentication algorithms.

PRF Algorithm

The acceptable PRF (Pseudo Random Function) algorithms.

MODP Group between x and y

The acceptable range for MODP group.

Renegotiate after h hrs m mins s secs

How long the initial IKE Security Association will stay in force. When it expires any attempt to send packets to the remote system will result in IKE attempting to establish a new SA.

Rekey after h hrs m mins s secs

When the time left until expiry for this SA reaches the value specified by this parameter, the IKEv2 SA will be renegotiated, such as a new IKEv2 SA is negotiated and the old SA is removed. Any IPSec child SAs that were created are retained and become children of the new SA.

- Click **Apply**.

 **Command line**

Command	Instance	Parameter	Values	Equivalent web parameter
ike2	0	rencalgs	des, 3des, aes	Encryption
ike2	0	renckeybits	128, 192, 256	Encryption (Minimum AES key length)
ike2	0	rauthalgs	md5, sha1	Authentication
ike2	0	rprfalgs	md5, sha1	PRF Algorithm
ike2	0	rdhmingroup	1, 2, 5	MODP Group between x and y
ike2	0	rdhmaxgroup	1, 2, 5	MODP Group between x and y
ike2	0	ltime	1-28800	Renegotiate after h hrs m mins s secs This CLI value is entered in seconds only.
ike2	0	rekeyltime	1-28800	Rekey after h hrs m mins s secs This CLI value is entered in seconds only.

Configure advanced IKEv2 Responder parameters

 **Web**

- Go to **Configuration > Network > Virtual Private Networking (VPN) > IPsec > IKEv2 > IKEv2 Responder > Advanced**.

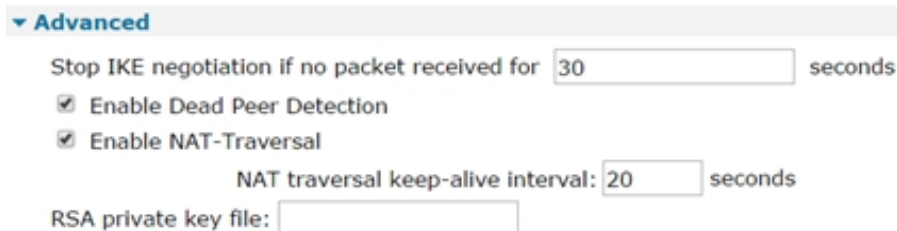

- Configure the advanced IKEv2 Responder parameters as needed:

Stop IKE negotiation if no packet received for n seconds

The period of time, in seconds, after which the router will stop the IKEv2 negotiation when no response to a negotiation packet has been received.

Enable NAT-Traversal

Enables support for NAT Traversal within IKE/IPsec. When one end of an IPsec tunnel is behind a NAT box, some form of NAT traversal may be required before the IPsec tunnel can pass packets. Turning NAT Traversal on enables the IKE protocol to discover whether or not one or both ends of a tunnel is behind a NAT box, and implements a standard NAT traversal protocol if NAT is not being performed.

The version of NAT traversal supported is that described in the IETF draft document [draft-ietf-ipsec-nat-t-ike-03](#).

NAT traversal keep-alive interval n seconds

The interval, in seconds, in which the NAT Traversal keepalive packets are sent to a NAT device in order to prevent NAT table entry from expiring.

RSA private key file

The name of a X.509 certificate file holding the router's private part of the public/private key pair in certificate exchanges. See [Use X.509 certificates with IPsec tunnels](#) for more information.

3. Click **Apply**.

**Command line**

Command	Instance	Parameter	Values	Equivalent web parameter
ike2	0	inactto	0-255	Stop IKE negotiation if no packet received for n seconds
ike2	0	natt	on, off	Enable NAT-Traversal
ike2	0	natkaint	Integer	NAT traversal keep-alive interval n seconds
ike2	0	privrsakey	Filename	RSA private key file

Configure Layer 2 Tunneling Protocol (L2TP)

The Layer 2 Tunneling Protocol (L2TP) provides a means for terminating a logical PPP connection on a device other than the one which terminates the physical connection. Typically, both the physical layer and logical layer PPP connections would be terminated on the same device, for example, a TransPort router.



With L2TP answering the call, the router terminates the layer 2 connection only and the PPP frames are passed in an L2TP tunnel to another device which terminates the PPP connection. This device is sometimes referred to as a Network Access Server (NAS).

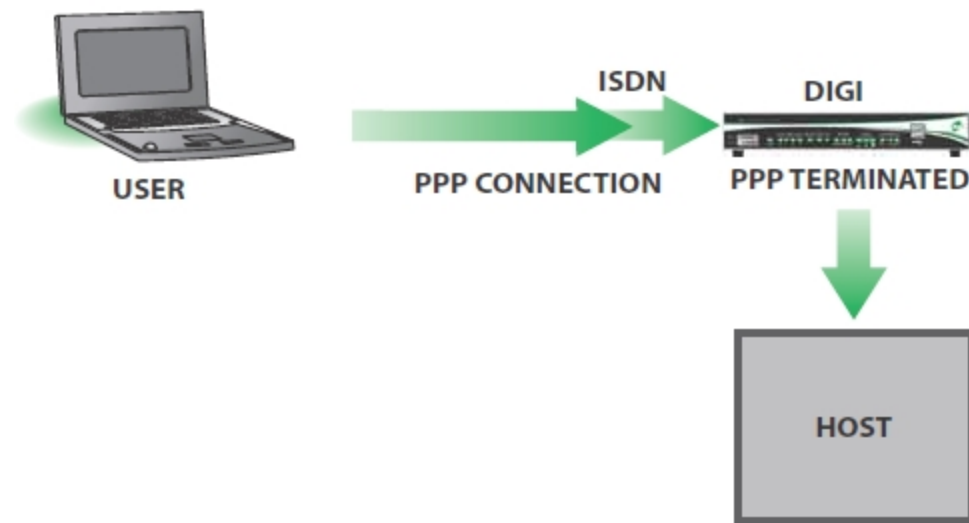

L2TP n parameters

Web

- Go to **Configuration > Network > Virtual Private Networking (VPN) > L2TP > L2TP n**.

- Configure the L2TP parameters:

Act as a listener only

When enabled, the router **doesnot** actively attempt to establish an L2TP tunnel. In this mode, it will only use L2TP if the remote host requests it. When unchecked, the router will actively try to establish an L2TP connection with the remote host.

Enable Server mode

When enabled, the router acts as an L2TP server.

Initiate connections to a.b.c.d

The IP address of the remote host, such as the device that will terminate the L2TP connection.

Use a.b.c.d as a backup

It is possible to specify a backup remote L2TP host server using this parameter. The text box contains the IP address of the remote server to use.

Bring this tunnel up All the time/On demand

This parameter only applies to tunnels initiated from this router.

Bring this tunnel down if it is idle for h hrs, m mins, s secs

These radio buttons select whether or not the tunnel is permanently available or not. When set to On demand, the tunnel will not activate automatically but will wait until it is triggered by PPP. When set to On demand the values in the text boxes determine the timeout after which the L2TP tunnel will closed down after the last L2TP call on that tunnel.

L2TP Window Size

The L2TP window size is selected from this drop down list. Available values are from **1** to **7**.

Route UDP packets over interface x,y

These two text boxes specify the interface and its instance number for L2TP UDP sockets. Specifying these parameters allow the router to raise the interface should it be disconnected.

Source Port Normal/Variable

These radio buttons select the source port for the L2TP tunnel. Setting this setting to **Normal** uses the default port number, **1701**. If set to **Variable**, this setting uses a random source port value.

Name

The name that identifies the router during the negotiation phase when establishing an L2TP tunnel.

Authentication Off/Secret

The radio buttons select whether or not to use authentication. This is normally set to **Off** as most host systems require using IPsec over L2TP tunnels. If **Authentication** is set to **On**, authentication is enabled and the **Secret** parameter becomes relevant. The value in the text box contains a passphrase shared with the host. The router uses this passphrase if the remote host requests authentication and **Authentication** is set to **Off** here.

3. Configure the advanced L2TP parameters as needed:

Retransmit interval s milliseconds

The amount of time, in milliseconds, the router waits before retransmitting a **Start Control Connection Request (SCCRQ)** frame. The default value of **250ms** should be changed to a higher value (say **4000ms**) if L2TP is running over a GPRS link.

Retransmit count n

When using L2TP over GPRS or satellite networks, the first few packets are sometimes lost. Setting the retransmit count in the text box to a higher value than the default of **5** will increase reliability of the tunnel.

Layer 1 Interface Sync port n/ISDN

These radio buttons select the layer 1 (physical) interface to use to terminate the L2TP connection. The available options are ISDN or one of the router's synchronous serial ports. When Sync port n is selected, the sync port number is selected from the drop-down list.

Allow this L2TP tunnel to answer incoming ISDN calls

When enabled, the L2TP entity answers incoming ISDN calls.

MSN

The filter for the ISDN Multiple Subscriber Numbering (MSN). It is blank by default but when the answering facility (above) is enabled, the router only answers ISDN calls where the trailing digits match this MSN value. For example, setting the MSN value to **123** prevents the router from answering calls from any calling number that does not end in **123**. Not applicable when answering is off.

Sub-address

The ISDN sub-address filter to use in conjunction with the ISDN answering function. When answering is set to **On** and there is a valid sub-address in this text box, the router only answers calls where the trailing digits of the calling sub-address match this sub-address. For example, setting the sub-address value to **123** prevents the router from answering calls where the sub-address does not end in **123**.

4. Click **Apply**.

**Command line****Configure L2TP parameters**

Command	Instance	Parameter	Values	Equivalent web parameter
l2tp	n	listen	off, on	Act as a listener only
l2tp	n	swap_io	off, on	Enable server mode
l2tp	n	remhost	Valid IP address a.b.c.d	Initiate connections to a.b.c.d
l2tp	n	backremhost	Valid IP address a.b.c.d	Use a.b.c.d as a backup
l2tp	n	aot	off, on	Bring this tunnel up All the time/On demand
l2tp	n	nocallto	0-4294967296	Bring this tunnel down if it is idle for h hrs, m mins, s secs
l2tp	n	window	1-7 Default=4	L2TP Window Size
l2tp	n	ll_ent	<blank>, PPP, ETH	Route UDP packets over interface x,y
l2tp	n	ll_add	0-2147483647	Route UDP packets over interface x,y
l2tp	n	rnd_srcport	off, on	Source Port
l2tp	n	name	Up to 30 characters	Name
l2tp	n	auth	off, on	Authentication Off/Secret
l2tp	n	secret	Up to 80 characters	Authentication Off/Secret

Configure advanced L2TP parameters

Command	Instance	Parameter	Values	Equivalent web parameter
l2tp	n	retxto	0-4294967296	Retransmit interval s milliseconds.
l2tp	n	retxcnt	0-4294967296	Retransmit count
l2tp	n	l1iface	0-255	Layer 1 Interface
l2tp	n	ans	off, on	Allow this L2TP tunnel to answer incoming ISDN calls.
l2tp	n	msn	Up to 9 digits	MSN
l2tp	n	sub	Up to 17 digits	Sub-address

Use X.509 certificates with IPsec tunnels

The previous discussion of IPsec tunnel configuration implemented security between two points of the tunnel by using a “pre-shared secret” or password. Certificates provide this sort of mechanism, but without the need to manually enter or distribute secret keys. To summarize, a user’s certificate is similar to a passport, providing proof that the user is who they say they are and enclosing details of how to use that certificate to decrypt data encoded with it. However, passports can be forged, so there also needs to be proof that the passport has been properly issued and hasn’t been changed since it was. On a paper passport, this is achieved by covering the photograph with a coating that shows if it has been tampered with, embedding the user’s name in code in a long string of numbers, etc. In the same way, for a Security Certificate to be genuine, it must be protected from alteration as well. Like a passport, you also have to trust that the issuer is authorized and competent to create the certificate.

Certificates use something called a “Public/Private Key Pair.” This is a complex area but the principle is that you can create an encryption key made up from two parts, one private (known only to the user), the other public (known to everyone). Messages encrypted with someone’s public key can only be recovered by the person with the Public AND Private key but as encrypting the message to someone in the first place only requires that you know their public key, anyone who knows that can send them an encrypted message, so you can send a secure message to someone knowing only their publicly available key. You can also prove who you are by including in the message your “identity” whereupon they can look up the certified public key for that identity and send a message back that only you can understand. The important principles are:

- Your private key cannot be determined from your public key.
- You both need to be able to look up the other’s certified ID.

Once you have established a two-way secure link, you can use it to establish some rules for further communication.

Before this gets any more complicated, let us assume Digi International is a competent authority to issue certificates, and examine how certificates work.

Generally, the issuing and management of certificates will be provided as a managed service by Digi or its partners, but some general information is provided here for system administrators.

Certificates are held in non-volatile files on the router. Any private files are named **privxxxx.xxx** and cannot be copied, moved, renamed, uploaded or typed. This is to protect the contents. They can be overwritten by another file, or deleted.

Two file formats for certificates are supported:

- **PEM:** Privacy Enhanced MIME
- **DER:** Distinguished Encoding Rules

Certificate and key files should be in one of these two formats, and should have an extension of **.pem** or **.der** respectively.

Note The equivalent filename extension for .pem files in Microsoft Windows is **.cer**. By renaming **.pem** certificate files to **.cer**, it is possible to view their makeup under Windows.

The router maintains two lists of certificate files.

- The first is a list of “Certificate Authorities” or CAs. The router uses the files in this list to validate public certificates sent by remote users. Public certificates must be signed by one of the certificates in the CA list before the router can validate them. Certificates with the

filename **ca*.pem** and **ca*.der** are loaded into this list at start-up time. In the absence of any CA certificates, a public certificate cannot be validated.

- The second list is a list of public certificates that the router can use to obtain public keys for decrypting signatures sent during IKE exchanges. Certificates with a filename **cert*.pem** and **cert*.der** are loaded into this list when the router is powered on or rebooted. The router uses certificates in this list when the remote router does not send a certificate during IKE exchanges. If the list does not contain a valid certificate communication with the remote unit cannot take place.

Both the host and remote units must have a copy of a file called **casar.pem**. This file is required to validate the certificates of the remote units.

In addition, the host unit should have copies of the files **cert02.pem** (which allows it to send this certificate to remote units) and **privrsa.pem**. Note that before it can send this certificate, the **Remote ID** parameter in the **Configuration > Network > Virtual Private Networking (VPN) > IPsec > IPsec Tunnels > IPsec n - n > IPsec n** page must be set to **host@Digi.co.uk**.

The remote unit must have copies of **cert01.pem** and **privrsa.pem**.

For more information on X.509 certificates, see [Manage X.509 certificates and host key pairs](#).

Web

1. Go to **Configuration > Network > Virtual Private Networking (VPN) > IPsec > IPsec Tunnels > IPsec n**.
2. Configure any IPsec tunnels that will use X.509 certificates for authentication as follows:

Our ID

Set to **info@Digi.co.uk**. This is the same as the subject **Altname** in certificate **cert01.pem**, which makes it possible for the router to locate the correct certificate to send to the host.

Authentication Method

Should be set to **RSA Signatures**. This indicates to IKE to use RSA signatures (certificates) for authentication. When IKE receives a signature from a remote unit, it must be able to retrieve the correct public key so that it can decrypt the signature, and confirm that the signature is correct. The certificate must either be on the FLASH file system, or be provided by the remote unit as part of the IKE negotiation. The router uses the ID provided by the remote unit to find the correct certificate to use. If the correct certificate is found, the code then checks that it has been signed by one of the certificate authority certificates (**ca*.pem**) that exist on the unit. The code first checks the local certificates, and then the certificate provided by the remote (if any). IKE will send a certificate during negotiations if it is able to find one that has subject **AltName** that matches the ID in use. If it cannot locate the certificate, the remote router must have local access to the file to retrieve the public key.

A typical setup may be that the host unit has a copy of all certificates. This means that the remote units only require the private key, and the certificate authority certificate. This eases administration as any changes to certificates need only be made on the host. Because they do not have a copy of their certificate, remote units rely on the host having a copy of the certificate. An alternative is that the remote units all have a copy of the certificate, as well as the private key and certificate authority certificate, and the host only has its own certificate. This scenario requires that the remote unit send its certificate during negotiations. It can validate the certificate because it has the certificate authority certificate.

3. Click **Apply**.

 **Command line**

Command	Instance	Parameter	Values	Equivalent web parameter
eroute	n	authmeth	rsa	Use the following security on this tunnel
eroute	n	ourid	ID string	Our ID

Configure Point-to-Point Tunneling Protocol (PPTP)

The Point-to-Point tunneling protocol (PPTP) is a common way of creating a VPN tunnel to a Microsoft Windows™ server.

PPTP works by ending a regular PPP session to the peer encapsulated by the Generic Routing Encapsulation (GRE) protocol. The router uses a second session on TCP port **1723** to initiate and manage the GRE session. PPTP connections are authenticated with Microsoft MSCHAP-v2 or EAP-TLS. VPN traffic is protected by MPPE encryption. PPTP does not work with GPRS/HSDPA mobile operators that assign a private IP address and then apply NAT to the traffic before it leaves their network. This because the server tries to build a tunnel back to the router on port **1723** but fails when the traffic is blocked by the mobile operator's firewall.

Web

1. Go to **Configuration > Network > Virtual Private Networking (VPN) > PPTP > PPTP n**.

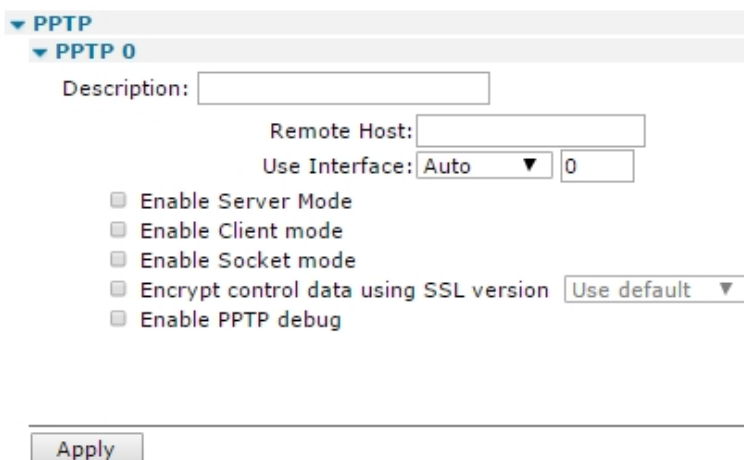

▼ PPTP

▼ PPTP 0

Description:

Remote Host:

Use Interface: Auto ▼ 0

Enable Server Mode

Enable Client mode

Enable Socket mode

Encrypt control data using SSL version Use default ▼

Enable PPTP debug

Apply

2. Configure PPTP parameters:

Description

An identifier for the router.

Remote Host a.b.c.d

The IP address of the remote host, such as the device that will terminate the PPTP connection.

Use Interface x,y

The interface name and instance to use for the PPTP tunnel. Specifying these parameters allow the router to raise the interface should it be disconnected. The interface options are:

- Auto
- PPP
- Ethernet

Accept incoming PPTP connections

When enabled, the router acts as a PPTP server and accepts incoming VPN connections.

Enable Server mode

When enabled, the router sends **call_out** call requests to the remote device. In the default state which is unchecked, the router sends a **call_in** request to the remote device.

Enable Socket mode

When enabled, enables the use of a Digi proprietary mode whereby PPP packets are sent via the PPTP control socket rather than in GRE packets.

Encrypt control data using SSL version n

When enabled, the router encrypts the control data using SSL. This is a Digi proprietary function and is not part of standard PPTP. The drop-down list allows the SSL version to be selected. The available options are:

- Use default
- TLSv1 only
- SSLv2 only

Enable PPTP debug

Enables debug tracing.

3. Click **Apply**.

 **Command line**

Command	Instance	Parameter	Values	Equivalent web parameter
pptp	0-9	name	Up to 30 characters	Description
pptp	0-9	remhost	Valid IP address a.b.c.d	Remote Host a.b.c.d
pptp	0-9	ll_ent	Blank, PPP, ETH Blank means Auto	Use Interface x,y
pptp	0-9	ll_add	0-4294967296	Use Interface x,y
pptp	0-9	listen	off, on	Accept incoming PPTP connections
pptp	0-9	swap_io	off, on	Enable Server mode
pptp	0-9	usesock	off, on	Enable Socket mode
pptp	0-9	sslver	Blank,SSL,TLS1,SSL2 Blank is disabled (default) SSL means use default.	Encrypt control data using SSL version n
pptp	0-9	debug	off, on	Enable PPTP debug

Configure OpenVPN

You can use OpenVPN to connect to the router for secure management and access services on the LAN side of the TransPort router, such as corporate messaging services, file servers and print servers for example. OpenVPN is a full-featured SSL VPN which implements OSI layer 2 or 3 secure network extension using the industry standard SSL/TLS protocol, supports flexible client authentication methods based on certificates, smart cards, and/or username/password credentials, and allows user or group-specific access control policies using firewall rules applied to the VPN virtual interface. OpenVPN is not a web application proxy and does not operate through a web browser.

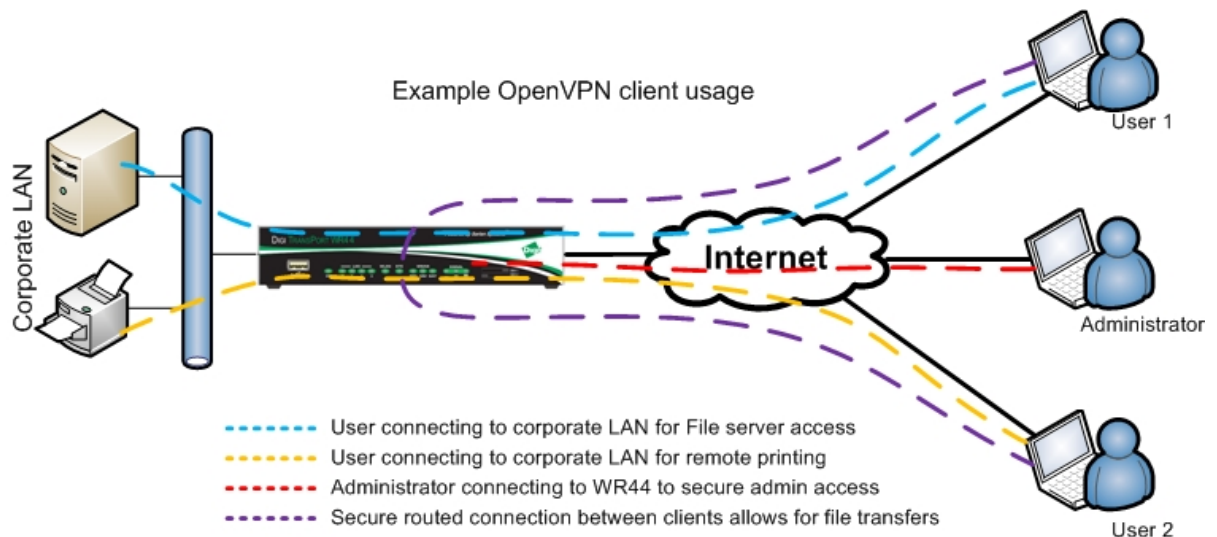

You can configure a Digi TransPort as an OpenVPN server, shown above, or as an OpenVPN client, connecting to an OpenVPN server.

On TransPort firmware, OpenVPN has been implemented as an interface. That means when an OpenVPN tunnel connects, an interface is added to the routing table. Static routes can be configured to point to an OpenVPN instance, and additionally, OpenVPN may learn routes from the tunnel peer and add these routes to the routing table for the duration of the OpenVPN tunnel. As each tunnel appears just like an interface, support for features like the firewall, NAT, IGMP, etc are the same as for other interfaces like PPP and ETH.

Additional information on OpenVPN configuration

See these application notes for further details and steps on setting up your router as an OpenVPN server:

- [Application Note 46: Configuring a TransPort WR as an OpenVPN server for Windows OpenVPN clients](#)
- [Application Note 47: Configuring a Windows OpenVPN server and a TransPort WR as an OpenVPN client](#)
- [Application Note 76: How to configure an Ubuntu OpenVPN server and a Digi TransPort WR as an OpenVPN client](#)
- [Quick Note 64: How to Troubleshoot OpenVPN On TransPort WR Routers](#)

Web

1. Go to **Configuration > Network > Virtual Private Networking (VPN) > OpenVPN > OpenVPN n**.

OpenVPN

OpenVPN 0

Description:

Use

IP address: Port

Protocol:

Keepalive TX Interval: seconds

Keepalive RX Timeout: seconds

Cipher:

Digest:

Route via: Routing table

Interface

Source IP address: From outgoing interface

Interface

Client Mode

Connect to OpenVPN server:

Automatically connect interface

Obtain IP address from the OpenVPN server

Obtain routes from the OpenVPN server

Obtain DNS server IP address from the OpenVPN server

Server Mode

Disconnect the tunnel if no IP traffic has been received for hrs mins secs

Enable NAT on this interface

IP address IP address and Port

Enable Firewall on this interface

Advanced

2. Configure OpenVPN parameters:

Description

The text string is a friendly name to help identify this OpenVPN instance.

Use

IP address a.b.c.d

This must be specified correctly. OpenVPN interfaces use a 30-bit mask. The first address is the network address, the second address is the server address, the third address is the client address, and the fourth address is the broadcast address. This address must be configured as

the second IP address in the block of four. For example, the IP address **192.168.0.1**, if configured as a server, or **192.168.0.2**, if configured as a client.

Destination host a.b.c.d

Required only when the router is configured as an OpenVPN client. This is the IP address of the OpenVPN server.

Link socket interface x,y

If configured, OpenVPN sockets are only allowed to/from this interface and the routing table will be ignored. When set to **Auto**, the OpenVPN sockets use the routing table to identify the best interface to use.

Get link socket source address from this interface x,y

The values in these two text boxes define the interface (**Auto, PPP, ETH**) and the instance number of the interface to use as a source address for IP sockets when not using the interface that the socket was created on.

Even when this parameter is not configured, the router uses the IP address from the interface on which the socket was created. It uses the source address specified in this parameter only if it will cause the traffic to match an Eroute and therefore be sent using IPsec or GRE.

MTU

Used to set the Maximum Transmit Unit for the OpenVPN instance, in bytes. The default setting is **1400**.

Metric

The connected metric, changing this value will alter the metric of dynamic routes created automatically for this interface.

NAT mode

Selects whether to use IP Network Address Translation (NAT) or Network Address and Port Translation (NAPT) at the Ethernet interface. When the parameter is set to disabled, no NAT will occur.

IP analysis

When enabled, the un-encapsulated IP traffic will be captured into the analyser trace.

Firewall

Enables or disables Firewall script processing for this interface.

IGMP

Enables or disables the transmission and reception of IGMP packets on this interface. IGMP advertises members of multicast groups. If IGMP is enabled, and a member of a multicast group is discovered on this interface, multicast packets for this group received on other interfaces are sent out this interface.

Include in RIP advertisements

When enabled, the router includes this static route in RIP advertisements.

Automatically connect interface

If enabled, this OpenVPN instance will be considered as an Always On interface.

Server mode (listener)

Configures the OpenVPN instance to listen for inbound OpenVPN sockets.

Link socket port

The default port for OpenVPN is **1194**. If you use a different or non-standard port number, specify it here.

Link socket protocol

OpenVPN can use TCP or UDP as the transport protocol. Select the required protocol here.

TLS auth password / Confirm TLS auth password

Allows the OpenVPN instance to use an extra level of security by having a TLS password configured.

Push IP address #1/#2/#3

When configured as an OpenVPN server, use these parameters to push subnets to the client that need to be routed via the OpenVPN server. Used in conjunction with the **Push Mask** parameter below.

Push mask #1/#2/#3

Use with the **Push IP address** parameter above to define subnets that should be routed via the OpenVPN server.

Push DNS server address #1/#2

When configured as an OpenVPN server, use these parameters to push DNS server settings to the OpenVPN client.

Pull interface IP address

When configured as an OpenVPN client, this option must be enabled for the router to obtain and use the local IP address supplied from the OpenVPN server.

Pull routes

When configured as an OpenVPN client, this option must be enabled for the router to use routes sent from the OpenVPN server.

Pull DNS server addresses

When configured as an OpenVPN client, this option must be enabled for the router to use DNS servers sent from the OpenVPN server.

Packet replay ID window

When set to a non-zero value, this enables sequence number replay detection. It indicates the number of packet IDs lower than the current highest ID to allow out of sequence.

Packet replay time window (seconds)

Set to a non-zero value to enable time tracking of incoming packets.

OpenVPN TX ping interval (seconds)

Interval between OpenVPN ping transmissions. These are required to detect the operational state of the VPN connection.

OpenVPN RX ping timeout (seconds)

The number of seconds, after which no OpenVPN ping has been received, the VPN will be marked as down.

Include IV

Enabling this option on includes an **IV** at the head of an encrypted packet. If one peer prepends this **IV** and the other isn't expecting it, packet decryption will fail.

Key negotiation timeout (seconds)

Maximum time, in seconds, to allow for a data channel key negotiation.

Key renegotiation interval (seconds)

Interval between key re-negotiations.

Key renegotiation bytes

If non-zero, a key renegotiation will take place after this many bytes have traveled through the data channel in either direction.

Key renegotiation packets

If non-zero, a key renegotiation will take place after this many packets have traveled through the data channel.

Inactivity timeout (seconds)

The tunnel is disconnected after the tunnel becomes inactive (that is, no IP traffic) for this many seconds. Note that the timer is only restarted with RX traffic, not TX traffic.

Data channel cipher

Sets the cipher for data channel encryption/decryption. Select from the dropdown list.

Data channel digest

Sets the digest algorithm for data channel authentication. Select from the dropdown list.

Debug

Enables output of OVPN related debug.

3. (Optional) Click **Advanced OpenVPN** parameters and configure advanced settings as needed.
4. Click **Apply**.

 **Command line**

Command	Instance	Parameter	Values	Equivalent web parameter
ovpn	n	descr	Up to 30 characters	Description
ovpn	n	IPaddr	Valid IP address a.b.c.d	IP address a.b.c.d
ovpn	n	dest	Valid IP address a.b.c.d	Destination host a.b.c.d
ovpn	n	ll_ent	<blank>, PPP, ETH	Link socket interface x,y x= interface type
ovpn	n	ll_add	0-2147483647	Link socket interface x,y y= interface number
ovpn	n	ip_ent	<blank>, PPP, ETH	Get link socket source address from this interface x,y x= interface type
ovpn	n	ip_add	0-2147483647	Get link socket source address from this interface x,y y= interface number
ovpn	n	mtu	0-2147483647	MTU
ovpn	n	metric	0-2147483647	Metric
ovpn	n	do_nat	0, 1, 2 0=Off 1=Address only 2= Address and port	NAT mode
ovpn	n	ipanon	off, on	IP analysis
ovpn	n	firewall	off, on	Firewall
ovpn	n	igmp	off, on	IGMP
ovpn	n	inrip	off, on	Include in RIP advertisements

Command	Instance	Parameter	Values	Equivalent web parameter
ovpn	n	autoup	off, on	Automatically connect interface
ovpn	n	server	off, on	Server mode (listener)
ovpn	n	port	0-65535	Link socket port
ovpn	n	proto	TCP,UDP	Link socket protocol
ovpn	n	tls_auth_key	Up to 30 characters	TLS auth password
ovpn	n	etls_auth_key		Enciphered version TLS auth password
ovpn	n	puship	Valid subnet a.b.c.d	Push IP address #1 a.b.c.d
ovpn	n	pushmask	Valid netmask a.b.c.d	Push mask #1 a.b.c.d
ovpn	n	puship2	Valid subnet a.b.c.d	Push IP address #2 a.b.c.d
ovpn	n	pushmask2	Valid netmask a.b.c.d	Push mask #2 a.b.c.d
ovpn	n	puship3	Valid subnet a.b.c.d	Push IP address #3 a.b.c.d
ovpn	n	pushmask3	Valid netmask a.b.c.d	Push mask #3 a.b.c.d
ovpn	n	pushdns	Valid IP address a.b.c.d	Push DNS server address #1 a.b.c.d
ovpn	n	pushdns2	Valid IP address a.b.c.d	Push DNS server address #2 a.b.c.d
ovpn	n	pullip	off, on	Pull interface IP address
ovpn	n	pullroute	off, on	Pull routes
ovpn	n	pulldns	off, on	Pull DNS server addresses
ovpn	n	sreplay	0-2147483647	Packet replay ID window
ovpn	n	treplay	0-2147483647	Packet replay time window (seconds)
ovpn	n	pingint	0-2147483647	OpenVPN TX ping interval (seconds)
ovpn	n	pingto	0-2147483647	OpenVPN RX ping timeout (seconds)
ovpn	n	inciv	off, on	Include IV

Command	Instance	Parameter	Values	Equivalent web parameter
ovpn	n	neg_timeout	0-2147483647	Key negotiation timeout (seconds)
ovpn	n	reneg_int	0-2147483647	Key renegotiation interval (seconds)
ovpn	n	reneg_bytes	0-2147483647	Key renegotiation bytes
ovpn	n	reneg_packets	0-2147483647	Key renegotiation packets
ovpn	n	inact_timeout	0-2147483647	Inactivity timeout (seconds)
ovpn	n	cipher	See cipher values in the following table.	Data channel cipher
ovpn	n	digest	See digest values in the following table.	Data channel digest
ovpn	n	debug	off, on	Debug

Supported Cipher and Digest values for OpenVPN

Cipher values	Digest values
DES-EDE-CBC	md2WithRSAEncryption
AES128	ssl2-md5
DES	MD5
DES-CBC	sha1WithRSAEncryption
AES-128-CBC	ssl3-sha1
AES192	ssl3-md5
AES-192-CBC	SHA1
DES-EDE3-CBC	MD2
AES-256-CBC	RSA-MD2
AES-256	md5WithRSAEncryption
DES3	RSA-SHA1
	RSA-SHA1-2
	RSA-MD5

Configuring Secure Sockets Layer (SSL)

About the Secure Sockets Layer (SSL)	535
Configure the SSL server	536
Configure SSL clients	538

About the Secure Sockets Layer (SSL)

The secure socket layer (SSL) provides a secure transport mechanism is supported by Digi's TransPort routers.

Some sites require client side authentication when connecting to them. The router's SSL client handles the authentication for SSL connections using certificates signed by a Certificate Authority (CA). For more information regarding certificates and certificate requests, see the web interface certificates page **Administration > X.509 Certificate Management > Certificate Authorities (CAs)** and [Manage X.509 certificates and host key pairs](#).

Configure the SSL server

Web

1. Go to **Configuration > Network > SSL**. The **SSL Server** section of the page describes the parameters needed to configure the SSL server.

Server Certificate Filename	Server Private Key Filename	SSL Version	Allow Insecure Ciphers	Cipher List	Verify Certificate	Certificate Required	Reject Self-Signed Certificates
cert01.pem	privrsa.pem	TLSv1.2 only	<input checked="" type="checkbox"/>		No	<input type="checkbox"/>	<input type="checkbox"/>

2. Configure the SSL server parameters:

Server Certificate Filename

The file containing the server certificate is selected from this drop-down list.

Client Private Key Filename

The file containing the private key that matches the above certificate is selected from this drop-down list.

SSL Version

The version of the SSL protocol to use, is selected from this drop-down list. Selecting **Any** allows the use of any version. The available options are:

- Any
- TLSv1 only
- SSLv2 only

Allow Insecure Ciphers

Allows use of 'insecure' Cipher-Block Chaining (CBC)-based ciphers. The default value is **On**.

Cipher List

The list of ciphers is the same as described above for the client-side configuration table.

Verify Certificate

Sets whether and how the SSL server verifies peer certificates.

- **No**: The SSL server does not verify peer certificates.
- **Yes**: The SSL server should verify the peer certificate if one is supplied.
- **Also verify date**: The SSL server checks certificate dates (not before, not after).

Certificate Required

When checked, sets that negotiation should fail if the peer does not supply a certificate.

Reject Self-Signed Certificates

When checked, sets that the SSL server rejects zero-depth, self-signed certificates.

3. Click **Apply**.

 **Command line**

Command	Instance	Parameter	Values	Equivalent web parameter
sslsvr	0	certfile	Up to 12 characters (DOS 8.3 format)	Server Certificate Filename
sslsvr	0	keyfile	Up to 12 characters (DOS 8.3 format)	Server Private Key Filename
sslsvr	0	ver	Blank, TLS1, SSL2	SSL Version
sslsvr	0	insecure	off, on	Allow Insecure Ciphers
sslsvr	0	verify	integer This value sets several bits in the definition for the SSL server. Bit 0 (value 1) indicates that the server should verify the peer certificate if one is supplied. Bit 1 (value 2) indicates that the certificate dates (not before, not after) are also checked. Bit 2 (value 4) indicates that the negotiation should fail if the peer doesn't supply a certificate. Bit 3 (value 8) indicates that zero-depth, self-signed certificates should be rejected. Default is 0 .	Verify Certificate, Certificate Required, and Reject Self-Signed Certificates
sslsvr	0	cipherlist	Colon-separated list	Cipher List
sslsvr	0	debug	off, on	n/a

Configure SSL clients

Web

1. Go to **Configuration > Network > SSL**. The **SSL Clients** section of the page has a table with columns and parameters as follows:

▼ SSL

SSL Clients

SSL Client	Client Certificate Filename	Client Private Key Filename	Allow Insecure Ciphers	Cipher List	Apply to Destination IP Address	Verify Server Certificate	Reject Self-Signed Certificates
0	<input type="text"/>	<input type="text"/>	<input checked="" type="checkbox"/>	<input type="text"/>	<input type="text"/>	Also verify date ▼	<input checked="" type="checkbox"/>
1	<input type="text"/>	<input type="text"/>	<input checked="" type="checkbox"/>	<input type="text"/>	<input type="text"/>	No ▼	<input type="checkbox"/>
2	<input type="text"/>	<input type="text"/>	<input checked="" type="checkbox"/>	<input type="text"/>	<input type="text"/>	No ▼	<input type="checkbox"/>
3	<input type="text"/>	<input type="text"/>	<input checked="" type="checkbox"/>	<input type="text"/>	<input type="text"/>	No ▼	<input type="checkbox"/>
4	<input type="text"/>	<input type="text"/>	<input checked="" type="checkbox"/>	<input type="text"/>	<input type="text"/>	No ▼	<input type="checkbox"/>
5	<input type="text"/>	<input type="text"/>	<input checked="" type="checkbox"/>	<input type="text"/>	<input type="text"/>	No ▼	<input type="checkbox"/>

2. Configure the SSL client parameters:

SSL Client

A list of the SSL client numbers supported by the router.

Client Certificate Filename

The name of the required certificate file is selected from those available on the router's filing system from this drop-down list.

Allow Insecure Ciphers

Allows use of 'insecure' Cipher-Block Chaining (CBC)-based ciphers. The default value is **On**.

Client Private Key Filename

The name of the file that contains the private key that matches the public key stored in the above parameter, is selected from this drop-down list.

Cipher List

The cipher list in this text box is a list of one or more cipher strings separated by colons. Commas or spaces are also accepted as separators but colons are normally specified. The actual cipher string can take several different forms. It can consist of a single cipher suite such as RC4-SHA. It can represent a list of cipher suites containing a certain algorithm or cipher suites of a certain type. For example, **SHA1** represents all cipher suites using the SHA1 digest algorithm. Lists of cipher suites can be combined in a single cipher string using the **+** character. This forms the logical AND operation. For example, **SHA1+DES** represents all cipher suites containing SHA1 and DES algorithms. If left empty, router does not use the cipher list.

For more information see <https://www.openssl.org/docs/man1.0.2/apps/ciphers.html>.

Apply to Destination IP Address

Allows the configuration of multiple SSL destinations, each having a different certificate/key pair. When set, this parameter will lock the SSL client settings to a specific IP address. If this parameter is left blank, the router uses the configured SSL client settings for any connection that requires SSL. As is usual with the tables on the configuration web pages, the relevant and appropriate parameters are selected and the **Add** button on the right-hand side is clicked to add the entry into the table. Once an entry has been added, it can be removed by clicking the **Delete** button in the right-hand column.

Reject Self-Signed Certificates

If enabled, a self-signed certificate delivered from the remote peer will be rejected unless a copy of the certificate exists on the router's local flash memory. The file must be named as per usual CA certificate convention for Digi TransPort routers, which is to prefix the name with **ca**, and use the extension **.pem** or **.der**. If disabled, the router accepts self-signed certificates whether or not a local copy of it exists.

3. Click **Apply**.

Command line

Command	Instance	Parameter	Values	Equivalent web parameter
sslcli	0-4	certfile	Up to 12 characters (DOS 8.3 format)	Client Certificate Filename
sslcli	0-4	keyfile	Up to 12 characters (DOS 8.3 format)	Client Private Key Filename
sslcli	0-4	cipherlist	Colon-separated list of ciphers	Cipher List
sslcli	0-4	insecure	on, off	Allow Insecure Ciphers
sslcli	0-4	IPaddr	Valid IP address	Apply to Destination IP Address

Configuring Secure Shell (SSH) server and client

About the Secure Shell (SSH) server	541
Configure SSH servers	542
Configure the SSH client	547
Generate SSH private keys	552
Perform SSH authentication with a public/private key pair	554

About the Secure Shell (SSH) server

The Secure Shell (SSH) server allows remote peers to access the router over a secure TCP connection using a suitable SSH client. The SSH server provides a Telnet-like interface and secure file transfer capability.

SSH uses a number of keys during a session. The router uses the host keys for authentication purposes. Keys unique to each SSH session are also generated and the router uses these keys for encryption/authentication purposes.

The router supports SSH v1.5 and SSH v2. The host key file format differs for each version but there would normally only be one host key for each version. For this reason the router allows the user to configure two host key files. These keys may be changed from time to time, specifically if it suspected that the key has become compromised. Because the host keys need to be secure, it is highly recommended to store the files on the router's FLASH filing system using filenames prefixed with **priv** which makes it impossible to read the files using any of the normal methods (such as FTP). It is possible (using the **genkey** command) to create host keys in either format for use with SSH. Using this utility it is not necessary to have the host key files present on any other storage device (thus providing an additional level of security). For details on generating a private key file, see [Generate SSH private keys](#).

Unlike the Telnet server, you can configure the number of SSH server sockets that listen for new SSH connections.

Multiple SSH server instances can be configured, each instance can be configured to listen on a separate port number and can use different keys and encryption methods.

You can configure which authentication methods the router uses in an SSH session and the preferred selection order. The router currently supports MD5, SHA1, MD5-96 and SHA1-96. If required, you can specify a public/private key pair for authentication.

The router currently supports 3DES, 3DES-CBC, and AES cipher methods.

DEFLATE compression is also supported. If DEFLATE compression is enabled and negotiated, SSH packets are first compressed before being encrypted, and delivered to the remote unit via the TCP socket.

Note The SSH server supports the SCP file copy protocol but does not support filename wildcards.

Configure SSH servers

TransPort routers support eight SSH servers, configured independently.

Web

1. Go to **Configuration > Network > SSH Servers**.
2. Click **Enable SSH Servers** to enable use of SSH for the router. The SSH server parameters display:

SSH Server 0

Enable SSH Server

Use TCP port:

Allow up to connections

Host Key 1 Filename:

Host Key 2 Filename:

Maximum login time: seconds

Maximum login attempts:

Use Deflate compression: No
 Yes, level

Enable Port Forwarding

Command Session IP Address: Port:

Enable support for SSH v1.5

Enable support for SSH v2.0

Actively start key exchange

Rekey: Never
 After KBytes of data have been transferred

Encryption Preferences:

3DES:

AES (128 bits):

AES (192 bits):

AES (256 bits):

Authentication Preferences:

MAC MD5:

MAC MD5-96:

MAC SHA1:

MAC SHA1-96:

MAC SHA256:

Enable Debug

3. Configure the SSH Server n parameters

Enable SSH Server

Enables the SSH server.

Use TCP port *p*

The TCP port number (default **22**) that the SSH server will use to listen for incoming connections. (Port **22** is the standard SSH port).

Allow up to *n* connections

The number of sockets listening for new SSH connections (default **1**).

Host Key 1 Filename

The filename of either an SSH V1 or V2 host key. It is highly recommended that the filename be prefixed with **priv** to ensure that the key cannot be easily accessed and compromised. This key may be generated using the facilities described in the Certificates section of this manual.

Host Key 2 Filename

The filename of either an SSH V1 or V2 key as above.

Note The maximum length for these filenames is **12characters** and they must use the DOS 8.3 file naming convention.

Maximum login time *s* seconds

The maximum length of time, in seconds, a user can successfully complete the login procedure once the SSH socket has been opened. The socket is closed if the user has not completed a successful login within this period.

Maximum login attempts *n*

The maximum number of login attempts allowed in any one session before the SSH socket will be closed.

Use Deflate compression No/Yes, level *n*

Sets use of DEFLATE compression. If compression is selected, the compression level is chosen from the drop-down list.

Enable Port Forwarding

When enabled, the router accepts traffic on ports other than **23**. This functionality is for use with SSH client applications, such as PuTTY, that have port forwarding capability. For example, one the SSH connection is active, traffic for the HTTP port **80** can be sent to the router securely.

Command Session IP Address *a.b.c.d* Port *p*

The values in these two text boxes specify the host IP address and port number that the router uses to handle incoming requests for a command session from SSH clients. This is instead of the router's normal command interpreter. For example, if the values are IP address **127.0.0.1**, port **4000**, the SSH client will make a direct connection to **ASY 0** and the device attached to **ASY 0** will receive and process the commands from the SSH client.

Enable support for SSH v1.5

When enabled, the server negotiates SSH V1.5. The router must also have a SSH V1 key present and the filename entered into the SSG configuration.

Server key size

This option applies to V1 SSH. During initialization of an SSH session, the server sends its host key and a server key (which should be of a different size to the host key). The router generates this key automatically but the length of the server key is determined by this parameter. If when this value is set it is too similar to the length of the host key, the router will automatically adjust the selected value so that the key sizes are significantly different.

Enable support for SSH v2.0

When enabled, the server negotiates SSH V2. The router must also have a SSH V2 key present and the filename entered into the SSG configuration.

Actively start key exchange

This option applies to V2 SSH. Some SSH clients wait for the server to initiate the key exchange process when a new SSH session is started unless they have data to send to the server, in which case they will initiate the key exchange themselves. When enabled, this setting causes the router to automatically initiate a key exchange without waiting for the client.

Rekey Never/After n units of data have been transferred

With SSH V2, it is possible to negotiate new encryption keys after using the current ones to encrypt a specified amount of data. The radio buttons enable or disable this feature. If enabled, enter the amount of data into the text box and select the applicable units (**Kbytes**, **Mbytes**, **Gbytes**) from the drop-down list.

Encryption Preferences

The following configuration options allocate preferences to the encryption method to encrypt data on the link. A lower value indicates greater preference. A value of **0** disables the option.

3DES

The preference level for the Triple-DES algorithm.

AES (128 bits)

The preference level for the 128-bit AES algorithm.

AES (192 bits)

The preference level for the AES algorithm using 192 bits.

AES (256 bits)

The preference level for the AES algorithm using 256 bits.

Authentication Preferences

The following configuration options allocate preferences for the authentication methods. As above, a value of **0** disables the particular authentication method, and lower values indicated greater preference than higher values. For example, if MAC SHA1-96 was the preferred method for authentication, this option would be given the value **1** and the other options given a value of **2** or greater. If all these parameters are set to the same value, the router automatically uses them in the following order:

- SHA1,
- SHA1-96
- MD5
- MD5-96

MAC MD5

The preference level for MAC MD5.

MAC MD5-96

The preference level for MAC MD5-96.

MAC SHA1

The preference level for MAC SHA1.

MAC SHA1-96

The preference level for MAC SHA1-96.

Enable Debug

The router supports logging and output of debugging information for situations where there are problems establishing a SSH connection. When enabled, this setting causes the router to trace and output information that should be helpful in diagnosing and resolving the problem.

4. Click **Apply**.

Command line

Command	Instance	Parameter	Values	Equivalent web parameter
ssh	0-7	port	0-65535	Use TCP port p
ssh	0-7	nb_listen	0-2147483647	Allow up to n connections
ssh	0-7	hostkey1	Up to 12 characters (8.3 format)	Host Key 1 Filename
ssh	0-7	hostkey2	Up to 12 characters (8.3 format)	Host Key 2 Filename
ssh	0-7	loginsecs	0-2147483647	Maximum login time s seconds

Command	Instance	Parameter	Values	Equivalent web parameter
ssh	0-7	logintries	0-2147483647	Maximum login attempts n
ssh	0-7	comp	0=disabled	Use Deflate compression, level
ssh	0-7	fwd	0-2147483647	Enable port forwarding
ssh	0-7	cmdhost	Valid IP address a.b.c.d	Command session IP address a.b.c.d
ssh	0-7	cmdport	0-2147483647	Command session port p
ssh	0-7	svrkeybits	0-2147483647	Server key size
ssh	0-7	initkex	off, on	Actively start key exchange
ssh	0-7	rekeybytes	0-2147483647 0=Do not rekey	Rekey After n units of data have been transferred
ssh	0-7	enc3descbc	0-2147483647 0=Disabled	3DES
ssh	0-7	encaes128cbc	0-2147483647	AES (128 bits)
ssh	0-7	encaes192cbc	0-2147483647	AES (192 bits)
ssh	0-7	encaes256cbc	0-2147483647	AES (256 bits)
ssh	0-7	macmd5	0-2147483647	MAC MD5
ssh	0-7	macmd596	0-2147483647	MAC MD5-96
ssh	0-7	macsha1	0-2147483647	MAC SHA1
ssh	0-7	macsha196	0-2147483647	MAC SHA1-96
ssh	0-7	debug	0, 1 0=Off 1=On	Enable Debug

Configure the SSH client

Web

1. Go to **Configuration > Network > SSH Client**.

SSH Client

Maximum handshake time: seconds

'known_hosts' Filename: ▼

'identity' Filename: ▼

'id_rsa' Filename: ▼

'id_rsa' Filename #2: ▼

Use Deflate compression: No
 Yes, level ▼

Enable Public Key Authentication

Enable Password Authentication

Encryption Preferences:

3DES: ▼

AES-CBC (128 bits): ▼

AES-CBC (192 bits): ▼

AES-CBC (256 bits): ▼

AES-CTR (128 bits): ▼

AES-CTR (192 bits): ▼

AES-CTR (256 bits): ▼

Authentication Preferences:

MAC MD5: ▼

MAC MD5-96: ▼

MAC SHA1: ▼

MAC SHA1-96: ▼

MAC SHA256: ▼

Enable Server Keepalives

Enable Debug

2. Configure the SSH client parameters:

Maximum handshake time

The time, in seconds, to wait for the server to begin the banner exchange part of the protocol after the socket connects.

'known_hosts' Filename

The name of file to use the regular SSH client.

'identity' Filename

The name of file to use as the regular SSH client.

'id_rsa' Filename

The name of an SSH V1 or V2 host key. There are two **id_rsa** files to allow the user to configure a SSHv1 private key into one field, and a SSHv2 private key into the other.

'_id rsa' Filename #2

The name of an SSH V1 or V2 host key.

Use Deflate compression No/Yes, level n

The radio buttons select whether or not to use DEFLATE compression. If enabled, select the compression level from the drop-down list.

Enable Public Key Authentication

When enabled, enables SSH public-key authentication to connect to OpenSSH.

Enable Password Authentication

When enabled, enables SSH password authentication to connect to OpenSSH.

Note No other authentication methods are supported.

Encryption preferences

The following configuration options allocate preferences to the encryption method for encrypting data on the link. A lower value indicates greater preference. A value of **0** disables the option.

3DES

The preference level for the Triple-DES algorithm.

AES (128 bits)

The preference level for the 128-bit AES algorithm.

AES (192 bits)

The preference level for the AES algorithm using 192 bits.

AES (256 bits)

The preference level for the AES algorithm using 256 bits.

Authentication Preferences

The following configuration options allocate preferences to the selected authentication methods. As above, a value of **0** disables the particular authentication method and lower values indicated greater preference than higher values. So, for example if **MAC SHA1-96** is the preferred method for authentication, this option is given the value **1** and the other options

given a value of **2** or greater. If all these parameters are set to the same value, the router automatically uses them in the following order: **SHA1, SHA1-96, MD5, MD5-96**.

MAC MD5

The preference level for MAC MD5.

MAC MD5-96

The preference level for MAC MD5-96.

MAC SHA1

The preference level for MAC SHA1.

MAC SHA1-96

The preference level for MAC SHA1-96.

Enable Server Keepalives

When enabled, enables server keepalives to use the same tcp connection for HTTP conversation instead of opening new one with each new request.

Enable Debug

The router supports logging and output of debugging information for situations where there are problems establishing a SSH connection. When enabled, this setting causes the router to trace and output information that should be helpful in diagnosing and resolving the problem.

3. Click **Apply**.

 **Command line**

Command	Instance	Parameter	Values	Equivalent web parameter
sshcli	0-7	conn_to	0-10 seconds	Time in seconds to wait for the server to begin the banner exchange part of the protocol after the socket connects.
sshcli	0-7	hostsfile	Up to 12 characters (8.3 format)	Key file to use as the regular SSH client.

Command	Instance	Parameter	Values	Equivalent web parameter
sshcli	0-7	idfile	Up to 12 characters (8.3 format)	Key file to use as the regular SSH client.
sshcli	0-7	idrsafile	Up to 12 characters (8.3 format)	Name of either an SSH V1 or SSH V2 host key.
sshcli	0-7	idrsafile1	Up to 12 characters (8.3 format)	Name of either an SSH V1 or SSH V2 host key.
sshcli	0-7	comp	0=disabled	Use Deflate compression, level.
sshcli	0-7	pubkeyauth	0=disabled	Enables SSH public-key authentication to connect to OpenSSH.
sshcli	0-7	pwdauth	0=disabled	Enables SSH password authentication to connect to OpenSSH.
sshcli	0-7	enc3descbc	0-2147483647 0=Disabled	3DES.
sshcli	0-7	encaes128cbc	0-2147483647	AES (128 bits).
sshcli	0-7	encaes192cbc	0-2147483647	AES (192 bits).
sshcli	0-7	encaes256cbc	0-2147483647	AES (256 bits).
sshcli	0-7	macmd5	0-2147483647	MAC MD5.
sshcli	0-7	macmd596	0-2147483647	MAC MD5-96.
sshcli	0-7	macsha1	0-2147483647	MAC SHA1.
sshcli	0-7	macsha196	0-2147483647	MAC SHA1-96.

Command	Instance	Parameter	Values	Equivalent web parameter
sshcli	0-7	svrliveint	0-2147483647	Interval in seconds to send the server a keepalive packet.
sshcli	0-7	svralivemax	number	Maximum number of keepalives to send without response before the connection is killed
sshcli	0-7	debug	0, 1 0=Off 1=On	Enable Debug

Generate SSH private keys

To fully configure SSH, you must generate a version 1 SSH key and a version 2 SSH key and configure the router to use them, described in the following topics.

Note SSH version 2 is more secure than version 1 and so is the recommended version to use. However, some SSH clients may only support version 1 keys and so the router supports both version 1 and version 2 SSH.

Web

1. Go to **Administration > X.509 Certificate Management > Key Generation**.
2. Select the size of the key file from the drop-down list. The larger the key file, the more secure it will be.
3. In the **Key filename** setting, enter the name for the key file, or select one of any existing key files. The filename should have a prefix of **priv** and a file extension of **.pem**, such as **privssh1.pem**. The 8.3 file name convention applies to key files.
4. Check the checkbox marked **Save in SSHv1 format** to generate a version 1 SSH key. Click the **Generate** Key button to generate the private key file. The key file is then stored in the router's FLASH filing system.
5. To generate the second key, repeat steps 1 through 3. This time, make sure that the **Save in SSHv1** format checkbox is unchecked. Give this key file a different name than the version 1 file previously generated.
6. On the **Configuration > Network > SSH Server > SSH Server n** page, enter the filename generated in step 3 into the **Host Key 1 Filename** text box and the filename generated in step 4 into the **Host Key 2 Filename** text box.
7. Click the **Apply** button at the bottom of the page to apply changes. When the **Configuration successfully applied** message is displayed, click on the highlighted link to save the configuration.

Command line

1. Generate the SSH V1 private key using the **genkey** command as follows:

```
genkey <keybits> <filename> -ssh1
```

where:

<keybits>

Is one of the following values; **384, 512, 768, 1024, 1536** or **2048**.

<filename>

Is the name for the file, such as **privssh1.pem**, as described for the web version of this procedure.

2. Generate the SSH V2 private key using the **genkey** command as in step 1, but this time, omit the **-ssh1** switch. For example:

```
genkey 1024 privssh2.pem.
```

3. Set the first private key as the SSH Host key 1 using the following command:

```
ssh 0 hostkey1 privssh1.pem
```

4. Set the second private key as SSH Host Key 2 using the following command:

```
ssh 0 hostkey2 privssh2.pem
```

5. Save the configuration:

```
config 0 save
```

Perform SSH authentication with a public/private key pair

Once SSH access has been configured and confirmed to be working, you can add RSA key pair authentication and use it to replace password authentication.

This process involves using PuTTYgen to create public and private keys. For full details on how to perform this operation, see [Quick Note 10 SSH Access using RSA Key Authentication](#).

Configuring FTP Relay

Configure FTP Relay	556
---------------------------	-----

Configure FTP Relay

FTP Relay agents allow any files to be transferred onto the router by a specified user, using the File Transfer Protocol (FTP). The files are temporarily stored in memory and then relayed to a specific FTP host. This is useful when using the router to collect data files from a locally attached device such as a webcam, which must then be to a host system over a slower data connection such as W-WAN. In effect, the routers acts as a temporary data buffer for the files.

You can configure the FTP relay agent to email as an attachment any file it could not transfer to the FTP server.

Configure FTP Relay agents

Web

1. Go to **Configuration > Network > FTP Relay**. There are two FTP Relay Agents available, with a separate web page for each.

▼ **FTP Relay**

▼ **FTP Relay 0**

Relay files for user to FTP Server

Server Username:

Server Password:

Confirm Server Password:

Remote directory:

Rename file:

Transfer Mode: ASCII Binary

Transfer Command: STORE APPEND

Attempt to connect to the FTP Server times

Wait seconds between attempts

Remain connected for seconds after a file has been transferred

If unable to relay file

Delete File
 Retain file (File will be lost if the router is powered down or is reset)

Email the file before storing or deleting it

Use Email Template File:

To:

From:

Subject:

▶ **FTP Relay 1**
▶ **Advanced**

2. Configure the FTP relay parameters:

Relay files for user locuser to FTP Server ftphost

The value in the left-hand text box is the name of the local user and should be one of the usernames assigned in the **Configuration > Security > Users** web page. This name then serves as the FTP login username when the local device needs to relay a file. The value in the right-hand text box is the name of the FTP host to which the files from the locally attached device are relayed.

Server Username

The username required to log in to the specified FTP host.

Server Password

The password to use to log in to the host.

Confirm Server Password

The password should be retyped into this text box in order to confirm that it has been entered correctly, given that it is not echoed in clear text.

Remote directory

The full name of the directory on the FTP host to which the file is to be saved.

Rename file

When enabled, the router stores the uploaded files internally with a filename in the form **relnnnn**, where **nnnn** is a number that is incremented for each new file received. When the file is relayed to the FTP host, the router uses the original filename. When unchecked, the file is stored internally using its original filename. This parameter should be set if a file having a filename longer than **12** characters is to be uploaded. This is because the internal file system uses the 8.3 filename format, such as **autoexec.bat**.

Transfer Mode ASCII / Binary

These two radio buttons select between the two possible file transfer modes, binary data or ASCII data.

Transfer Command STORE / APPEND

These two radio buttons select between the two possible storage methods, either append to or replace existing file.

Attempt to connect to the FTP Server n times

The number of connection attempts that the router should make if the first attempt is not successful.

Wait s seconds between attempts

The interval, in seconds, the router should wait in between successive connections attempts.

Remain connected for s seconds after a file has been transferred

How long, in seconds, the router maintains the connection to the FTP host after transferring a file.

If unable to relay file Delete File / Retain file

These two radio buttons select the behavior with respect to storing the file if the router fails to connect to the FTP host (after retrying for the specified number of attempts). Select **Delete File** if the file should not be stored permanently. If the file is retained, manual intervention is required to recover it at a later stage.

Note If the file is not retained, it will be lost if the power is removed from the router.

Email the file before storing or deleting it

The configuration options following setting are normally disabled (they should appear disabled in the browser). When this setting is enabled, the parameters are enabled and you can enter data in the text boxes.

Use Email Template File

The name of the template file that forms the basis of any email messages generated by the FTP Relay Agent. This would normally be the standard **EVENT.EML** template provided with the router but alternative templates may be created if necessary (see [Configure sending email alert messages when events occur](#)).

To

The email address of the recipient of email messages generated by the FTP Relay Agent.

From

The email address of the router. In order for this to work, an email account must be in place with the Internet Service Provider.

Subject

A brief description of the content of the email.

3. Click **Apply**.

 **Command line**

There are two FTP Relay Agents available. On **frelay** commands, the instance number can be **0** or **1**.

Command	Instance	Parameter	Values	Equivalent web parameter
frelay	n	locuser	Up to 15 characters	Relay files for user locuser
frelay	n	ftphost	Up to 64 characters	to FTP Server ftphost

Command	Instance	Parameter	Values	Equivalent web parameter
frelay	n	ftpuser	Up to 20 characters	Server Username
frelay	n	ftppwd	Up to 20 characters	Server Password
frelay	n	ftppdir	Up to 40 characters	Remote directory
frelay	n	norename	off, on	Rename file
frelay	n	ascii	off, on	Transfer Mode
frelay	n	appe	off, on	Transfer Command
frelay	n	retries	0-2147483647	Attempt to connect to the FTP Server n times
frelay	n	retryint	0-2147483647	Wait s seconds between attempts
frelay	n	timeout	0-2147483647	Remain connected
frelay	n	savemode	off, on	Delete/Retain file
frelay	n	smtp_temp	Up to 40 characters	Use Email Template File
frelay	n	smtp_to	Up to 100 characters	To
frelay	n	smtp_from	Up to 40 characters	From
frelay	n	smtp_subject	Up to 40 characters	Subject

Configure Advanced FTP Relay parameters

Web

Go to **Configuration > Network > FTP Relay > Advanced**.

Tx Buffer Size n bytes

The value in this text box specifies the size of the Tx socket buffer.

Command line

Command	Instance	Parameter	Values	Equivalent web parameter
ftpccli	n	txbuf	0-2147483647	Tx Buffer Size

Configure an SMTP client, as needed

If you choose to have FTP relay agent to email as an attachment any file it could not transfer to the FTP server, configure the FTP Relay settings **Email Template**, **To**, **From**, and **Subject**. Then, configure a Simple Mail Transfer Protocol (SMTP) client. Go to **Configuration > Alarms > SMTP Account** or use the **smtp** command. See [Configure an SMTP email account to send alarms](#) for configuration instructions.

Configuring IP passthrough

Configure IP passthrough	562
--------------------------------	-----

Configure IP passthrough

IP passthrough is a useful feature if a host computer or server on the local area network needs to have access to it from the Internet with a public IP address. With IP passthrough configured, all IP traffic, not just TCP/UDP is forwarded back to the host computer. This feature can be useful for applications that do not function reliably through network address translation.

In this configuration, the local PC shares the public IP addressing information with the WAN side of the router.

Web

1. Go to **Configuration - Network > IP Passthrough**.

IP Passthrough

IP Passthrough mode essentially turns the Digi TransPort into a bridge, disabling NAT and routing and passing t
Pinholes are services that are terminated on the Digi TransPort instead of being passed through to the connecte

Enable IP Passthrough

Local interface:

WAN PPP interface:

Ethernet DHCP Mode:

DHCP Lease Time: seconds

Pinhole Configuration:

- HTTP
- HTTPS
- Telnet
- Telnet over SSL
- SSH/SFTP
- SNMP
- GRE
- Ping

Other Ports:

Other Protocols:

2. Configure IP passthrough parameters:

Enable IP Pass-through

Enables IP passthrough mode.

Local interface

The local interface to which the local PC is connected, either an Ethernet or PPP connection.

WAN PPP interface

The PPP interface that will share its WAN address with the local PC.

Ethernet DHCP Mode

Selects the mode of operation for the passthrough functionality. The available options are **Normal/24 bit mask** and **Fixed IP Address/32 bit mask**. The default is **Normal/24 bit mask**.

When **Fixed IP/32 bit mask** mode of operation is selected, the DHCP server provides a 32-bit subnet mask to the client and sets the address/subnet mask for the Ethernet interface to **192.168.1.1/32**.

DHCP Lease Time

The length, in minutes, of the leases issued by this DHCP server.

Pinhole Configuration

These parameters exclude specific protocols from the IP passthrough feature. An excluded protocol terminates at the router instead of being forwarded to the local PC.

HTTP

Excludes HTTP from passthrough.

HTTPS

Excludes HTTPS from passthrough.

Telnet

Excludes Telnet from passthrough.

Telnet over SSL

Excludes SSL from passthrough.

SSH/SFTP

Excludes SSH/SFTP from passthrough.

SNMP

Excludes SNMP from passthrough.

GRE

Excludes GRE from passthrough.

Ping

Excludes the ICMP echo request from passthrough.

Other Ports

The list of TCP and UDP port numbers in this text box are added to the list of port numbers that are not forwarded to the local PC. Separate port numbers by commas.

Other Protocols

The list of protocol numbers in this text box are added to the list of port numbers that are not forwarded on to the local PC. Separate port numbers by commas.

3. Click **Apply**.

 **Command line**

Command	Instance	Parameter	Values	Equivalent web parameter
passthru	0	enabled	off, on	Enable IP Pass-through
passthru	0	ethadd	0-2147483647	Ethernet interface
passthru	0	pppadd	0-2147483647	PPP interface
passthru	0	mode	0, 1 0=Normal 1=32-bit mask	Mode
passthru	0	http	off, on	HTTP
passthru	0	https	off, on	HTTPS
passthru	0	telnet	off, on	Telnet
passthru	0	telnets	off, on	Telnet over SSL
passthru	0	ssh	off, on	SSH/SFTP
passthru	0	snmp	off, on	SNMP
passthru	0	gre	off, on	GRE
passthru	0	ping	off, on	Ping
passthru	0	ports	Comma-separated list of ports	Other Ports
passthru	0	protos	Comma-separated list of protocols	Other Protocols

Configuring UDP echo

Configure a UDP echo client	566
-----------------------------------	-----

Configure a UDP echo client

When enabled, the UDP echo client generates UDP packets that contain the router's serial number and ID and transmits them to the IP address specified by the configuration. When the remote router receives a UDP packet on a local port and UDP echo server is configured, it will echo the packet back to the sender. There may be more than one UDP echo instance available on the router. When specifying the local port to listen on, the router uses Instance **0**.

Web

1. Go to **Configuration > Network > UDP Echo**. Depending on your router model, there may be instances of the UDP echo task supported by the router. Each has its own configuration web page, described below. For the command line configuration, valid instance numbers start at **0**.

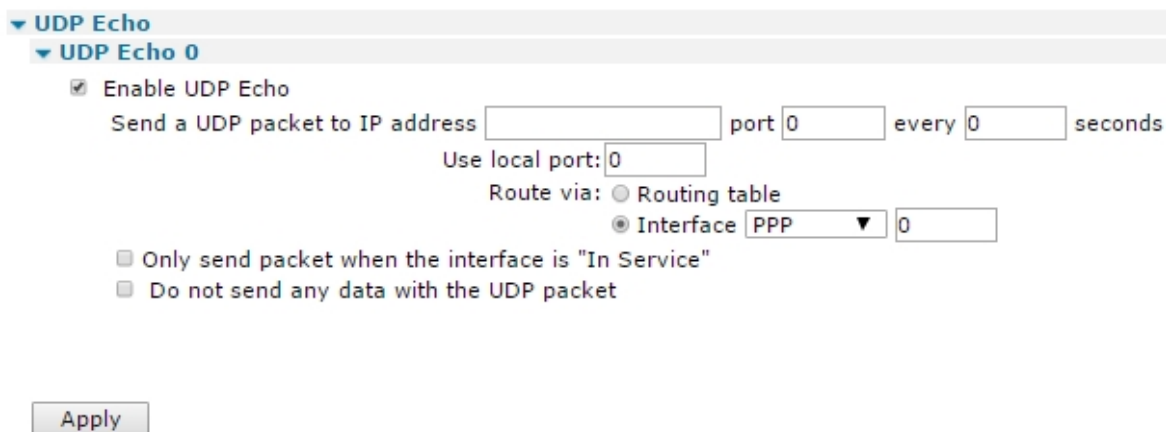

▼ UDP Echo
 ▼ UDP Echo 0

Enable UDP Echo
 Send a UDP packet to IP address port every seconds
 Use local port:
 Route via: Routing table
 Interface
 Only send packet when the interface is "In Service"
 Do not send any data with the UDP packet

Apply

2. Configure the UDP echo parameters:

Enable UDP Echo

This setting is disabled by default. When enabled, the configuration parameters associated with send UDP echo packets are displayed.

Send a UDP packet to IP address a.b.c.d port n every s seconds

The values in these three text boxes define the destination IP address for the UDP packets, the port number to which they should be sent and the sending interval. If the destination IP address is left blank, the router will not attempt to send any packets.

Use local port n

The local port the router should listen on for UDP packets. If any UDP packets are sent to this port, the router will send a copy back to the IP address and port they were sent from.

Route via Routing table / Interface x,y

These two radio buttons select whether the router should use its routing table to determine how to send the UDP packets or whether it should use the specified interface. If the specific interface is selected, the interface is selected from the drop-down list. The options available are PPP and Ethernet. The interface instance is specified in the adjacent text box.

Only send packet when the interface is “In Service”

When checked, and the router is using the specified interface, this setting prevents the router from sending UDP packets if the interface is out of service.

Do not send any data with the UDP packet

When checked, causes the router to send only a single null data byte. This is useful to minimize packet size when the interface has high data charges, such as W-WAN. When unchecked, the router sends packets containing the router’s serial number and ID as text.

3. Click **Apply**.

 **Command line**

Depending on your router model, there may be instances of the UDP echo task supported by the router. Valid instance numbers begin at **0**.

Entity	Instance	Parameter	Values	Equivalent web parameter
udpecho	n	dstip	Valid hostname	Send a UDP packet to IP address a.b.c.d port n every s seconds
udpecho	n	dstport	0-65535	Send a UDP packet to IP address a.b.c.d port n every s seconds
udpecho	n	interval	0-2147483647	Send a UDP packet to IP address a.b.c.d port n every s seconds
udpecho	n	locport	0-65535	Use local port n
udpecho	n	userouting	off, on	Route via Routing table
udpecho	n	ifent	PPP,ETH	Interface x,y
udpecho	n	ifadd	Valid interface instance 0-4294967296	Interface x,y
udpecho	n	onlyis	off, on	Only send packet when the interface is In Service
udpecho	n	nodata	off, on	Do not send any data with the UDP packet

Configuring Quality of Service (QoS)

Configure Quality of Service (QoS)	569
--	-----

Configure Quality of Service (QoS)

The Quality of Service (QoS) functionality allows prioritizing different types of IP traffic. Generally, networking devices use QoS to ensure that low priority applications do not use most of the available bandwidth to the detriment of those having a higher priority. For example, this might mean that EPOS transactions carried out over XOT are prioritized over HTTP-type traffic for internet access. Without some form of QoS, all IP packets are treated as equal, such as there is no discrimination between applications.

The IP packet **Type of Service (TOS)** field indicates how to prioritize a packet. Using the top 6 bits of the TOS field, a router that supports QoS will assign a Differentiated Services Code Point (DSCP) code to the packet. This may take place within the router when it receives the packet or another router closer to the packet source may have already assigned it. Based on the DSCP code, the router will assign the packet to a priority queue. There are currently four such queues for each PPP instance within the router. Each queue can be configured to behave a particular way so that packets in that queue are prioritized for routing according to predefined rules.

There are two ways to implement priority:

- Configure a priority queue to allow packets to be routed at a specific data rate (providing that queues of a higher priority are not already using the available bandwidth).
- Have the router use Weighted Random Early Dropping (WRED) of packets as queues become busy, to get the TCP socket generating the packets to back off its transmit timers. This prevents the queue overflow, which results in dropping all subsequent packets.

QoS is a complex subject and can have a significant impact on the performance of the router. For detailed background information on QoS, see the IETF document [RFC 2474: Definition of the Differentiated Services Field \(DS Field\) in the IPv4 and IPv6 Headers](#).

In Digi TransPort routers, the classification of incoming IP packets for the purposes of QoS takes place within the firewall. The firewall allows the system administrator to assign a DSCP code to a packet with any combination of source/destination IP address/port and protocol. Details of how this is done are given in the section on firewall scripts.

When the routing code within the router receives an incoming packet, it directs it to the interface applicable to that packet at that time (this is the case whether or not QoS is being applied). Just before the packet is sent to the interface, the QoS code intercepts the packet and assigns it to one of the available priority queues (currently **10** per PPP instance) based on its DSCP value.

Each priority queue has a profile assigned to it. This profile specifies parameters such as the minimum transmit rate to attempt, maximum queue length, and WRED parameters.

The packet is then processed by the queue management code, and either dropped or placed in the queue for later transmission.

Web

1. Go to **Configuration - Network > QoS** page. There are several groups of settings:
 - The **Configuration > Network > QoS > DSCP Mappings** page contains parameters to configure DSCP operation.
 - The **Configuration > Network > Queue Profiles** page contains parameters to manage the queue “profiles.”
 - In addition, each **Configuration > Interfaces > Ethernet and Configuration > Interfaces > PPP** instance page contains a **QoS** page that controls how QoS behaves on that particular interface.

When configuring QoS, note that the router supports ten queues, numbered from **0** to **9**, and that DSCP codes range from **0** to **64**.

2. Click **DSCP Mappings**. This page contains parameters to configure DSCP operation. Each DSCP value must be mapped to a queue.

▼ QoS
 ▼ DSCP Mappings
 DiffServ Codepoint (DSCP) to Queue Mappings

DSCP	Queue
Default	Q4 ▼
DSCP 0 (BE)	Q4 ▼
DSCP 8 (CS1)	Q3 ▼
DSCP 16 (CS2)	Q3 ▼
DSCP 24 (CS3)	Q2 ▼
DSCP 32 (CS4)	Q2 ▼
DSCP 40 (CS5)	Q2 ▼
DSCP 48 (CS6)	Q1 ▼
DSCP 56 (CS7)	Q1 ▼
DSCP 10 (AF11)	Q4 ▼
DSCP 12 (AF12)	Q4 ▼
DSCP 14 (AF13)	Q4 ▼
DSCP 18 (AF21)	Q3 ▼
DSCP 20 (AF22)	Q3 ▼
DSCP 22 (AF23)	Q3 ▼
DSCP 26 (AF31)	Q2 ▼
DSCP 28 (AF32)	Q2 ▼
DSCP 30 (AF33)	Q2 ▼
DSCP 34 (AF41)	Q1 ▼
DSCP 36 (AF42)	Q1 ▼
DSCP 38 (AF43)	Q1 ▼
DSCP 46 (EF)	Q0 ▼
DSCP 1	Default ▼
DSCP 2	Default ▼
DSCP 3	Default ▼
DSCP 4	Default ▼

Default

Selects the default queue. When this is changed, any DSCP codes that are set to use the default will have their queue number changed.

DSCP

A list of valid DSCP codes with an associated drop-down list box to the right.

Queue

Each of the DSCP codes in the left-hand column has a queue associated with it. To change the value from what is shown, select the desired value from the drop-down list.

- Click **Queue Profiles** and configure queue profile parameters. The **Configuration > Network > QoS > Queue Profiles** page contains parameters to manage the queue profiles. The queue profile determines how QoS queues with that profile assigned to them will behave. Up to 12 queue profiles can be defined using this page. These profiles can then be assigned to QoS queues as needed.

▼ Queue Profiles

Queue Profile	Minimum kbps	Maximum kbps	Maximum Packet Queue Length	WRED Minimum Threshold	WRED Maximum Threshold	WRED Maximum Drop Probability (%)	WRED Queue Length Weight factor
0	64	64	50	25	50	10	1
1	64	64	50	25	50	10	1
2	64	64	50	25	50	10	1
3	64	64	50	25	50	10	1
4	64	64	50	25	50	10	1
5	64	64	50	25	50	10	1
6	64	64	50	25	50	10	1
7	64	64	50	25	50	10	1
8	64	64	50	25	50	10	1
9	64	64	50	25	50	10	1
10	64	64	50	25	50	10	1
11	64	64	50	25	50	10	1

Queue Profile

The queue number that relates to the queues defined in the DCSP mappings page.

Minimum kbps

The minimum data transfer rate in kilobits/second that the router will try to attain for the queue.

Maximum kbps

The maximum data transfer rate in kilobits/second that the router tries to attain for this queue. This means that if the router determines that bandwidth is available to send more packets from a queue that has reached its **Minimum kbps** setting, it sends more packets from that queue until the **Maximum kbps** setting is reached.

If the bandwidth on a queue should be restricted, setting the **Maximum kbps** value to the same as, or lower than the **Minimum kbps** value ensures that only the **Minimum kbps** setting is achieved.

Maximum Packet Queue Length

The maximum length of a queue in terms of the number of packets in the queue. Any packets received by the router that would cause the maximum length to be exceeded, are dropped.

WRED Minimum Threshold

The minimum queue length threshold for using the WRED algorithm to drop packets. Once the queue length exceeds this value, the WRED algorithm may cause packets to be dropped.

WRED Maximum Threshold

The maximum queue length threshold for using the WRED algorithm to drop packets. Once the queue length exceeds this value, the WRED algorithm causes all packets to be dropped.

WRED Maximum Drop Probability (%)

The maximum percentage probability the WRED algorithm uses to determine whether or not a packet should be dropped when the queue length is approaching the WRED maximum threshold value.

Note If the length of a queue is less than the **WRED Minimum Threshold** value, there is a zero-percent chance that a packet will be dropped. When the queue length is between the WRED minimum and maximum values, the percent probability of a packet being dropped increases linearly up to the WRED maximum drop probability.

WRED Queue Length Weight factor

A weighting factor the WRED algorithm uses when calculating the weighted queue length. The weighted queue length is based on the previous queue length and has a weighting factor that may be adjusted to provide different transmit characteristics. The actual formula is:

$$\text{new_length} = (\text{old_length} * (1 - 1/2^n)) + (\text{current_length} * 1/2^n)$$

Small weighting factor values result in a weighted queue length that moves quickly and more closely matches the actual queue length. Larger weighting factor values result in a queue length that adjusts more slowly. If a weighted queue length moves too quickly (small weighting factor), it can result in dropped packets if the transmit rate rises quickly, but will also recover quickly after the transmit rate tails off. If a weighted queue length moves too slowly (large weighting factor), it allows a burst of traffic through without dropping packets, but may result in dropped packets for some time after the actual transmit rate drops off. Therefore, use care in selecting the weighting factor to suit the type of traffic using the queue.

- Click **DSCP alteration**. On this page, you can update the DSCP values on an IP stream (with matching DSCP value) if the measured throughput for that stream goes above a certain value. Other parts of the network will slow the traffic down if necessary. You can also update the DSCP values on traffic inside a GRE tunnel.

▼ DSCP alteration

Queue Profile	DSCP change start kbps	DSCP change stop kbps	DSCP to set	Set DSCP in GRE
0	0	0	BE ▼	<input type="checkbox"/>
1	0	0	BE ▼	<input type="checkbox"/>
2	0	0	BE ▼	<input type="checkbox"/>
3	0	0	BE ▼	<input type="checkbox"/>
4	0	0	BE ▼	<input type="checkbox"/>
5	0	0	BE ▼	<input type="checkbox"/>
6	0	0	BE ▼	<input type="checkbox"/>
7	0	0	BE ▼	<input type="checkbox"/>
8	0	0	BE ▼	<input type="checkbox"/>
9	0	0	BE ▼	<input type="checkbox"/>
10	0	0	BE ▼	<input type="checkbox"/>
11	0	0	BE ▼	<input type="checkbox"/>

Queue Profile

The queue number that relates to the queues defined in the DCSP mappings page.

DSCP change start kbps

The throughput when changing the DSCP value is enabled.

DSCP change stop kbps

The throughput when changing the DSCP value is disabled.

DSCP to set

The value to set the DSCP value to.

Set DSCP in GRE

Enables setting the DSCP of IP packets within GRE tunnels.

- Click **Apply**.

 **Command line**

Configure DSCP mappings

Command	Instance	Parameter	Values	Equivalent web parameter
dscp	n	q	0-63 Default 4	Queue

- To display a DSCP mapping from the command line, enter:

```
dscp <code> ?
```

Where **<code>** is a valid DSCP code from **0** to **63**, or **64** (see note below).

- To change the value of a parameter, enter:

```
dscp <code> q <value>
```

Where **<code>** is a valid DSCP code and **<value>** is from **0** to **9**.

- To set the default mapping value, enter:

```
dscp 64 q <value>
```

Where **<value>** is the default queue number required and has a value from **0** to **9**.

Note DSCP code **64** is not actually a valid code, but is employed here to set up the default priority.

Configure Queue Profiles parameters

Entity	Instance	Parameter	Values	Equivalent web parameter
qprof	n	minkbps	0-2147483647	Minimum kbps
qprof	n	maxkbps	0-2147483647	Maximum kbps
qprof	n	qlen	0-2147483647	Maximum Packet Queue Length
qprof	n	minth	0-2147483647	WRED Minimum Threshold
qprof	n	maxth	0-2147483647	WRED Maximum Threshold
qprof	n	mprob	0-100	WRED Maximum Drop Probability (%)
qprof	n	wfact	0-2147483647	WRED Queue Length Weight factor

- To display a queue profile, enter:

```
gqprof <instance> ?
```

Where **<instance>** is the number of the queue profile to be displayed.

- To change the value of a parameter, enter:

```
qprof <instance> <parameter> <value>
```

- To set the maximum throughput for queue profile **5** to **10kbps**, enter:

```
qprof 5 maxkbps 10
```

DSCP alteration

Command	Instance	Parameter	Values	Equivalent web parameter
qprof	n	setdscponkbps Note: If this value is set to 0 (the default), the DSCP value is not changed.	0=off 1=on	DSCP change start kbps
qprof	n	setdscpoffkbps	0=off 1=on	DSCP change stop kbps
qprof	n	setdscpval	integer	DSCP to set
qprof	n	setdscpgre	off, on	Set DSCP in GRE

Configuring time bands

Configure a time band	577
Enable and disable time bands for a PPP or Wi-Fi interface	579

Configure a time band

Digi TransPort routers support time bands. Time bands determine periods of time during which the router allows activating PPP or Wi-Fi interfaces or prevents them from activating. For example, a router in an office could be configured so that the ADSL PPP interface is only raised on weekdays.

You can apply time bands to **PPP** and **Wi-Fi** interface instances only.

Time bands are specified by a series of transition times. At each of these times, routing is either enabled or disabled. The default state for a time band is **On**, which means that PPP instances that are associated with unconfigured time bands will operate normally.

The router supports four time band configurations.

Whenever a time band transition occurs, an entry is made in the event log.

Web

1. Go to **Configuration > Network > Timebands**.

Timeband 0
You may specify up to 10 transitions

Timeband transitions		
Days	Time	State
No transitions have been configured		
<input type="checkbox"/> All <input type="checkbox"/> Mon->Fri <input type="checkbox"/> Sat->Sun <input type="checkbox"/> Sun <input type="checkbox"/> Mon <input type="checkbox"/> Tue <input type="checkbox"/> Wed <input type="checkbox"/> Thu <input type="checkbox"/> Fri <input type="checkbox"/> Sat	<input type="text"/>	On ▼
<input type="button" value="Add"/>		

2. Several **Timebands n** pages configure one time band instance each. Configuration is controlled by a table, with the following parameters. You can configure up to **10** time band transitions.

Days

A set of checkboxes for selecting the days of the week to which the time band transitions apply. You can select days individually or in groups for convenience. To select all the days of the week, check the **All** checkbox. To select the weekend only, check the **Sat->Sun** checkbox. To select weekdays only, check the **Mon->Fri** checkbox.

Time

The transition time, specified in 24-hour format with a colon separator between hours and minutes.

State

The routing state, which can be **On** or **Off**. For convenience, this parameter toggles state for each new addition; if an **On** transition is configured, the default state for the next addition is **Off**. Clicking the **Add** button adds the entry into the table. Once an entry is added to the table, remove it by clicking the associated **Delete** button. To activate this time band instance, navigate to the associated **PPP Timeband** configuration page, and click the **Enable** checkbox, or enter the equivalent command line command.

3. Click **Apply**.

 **Command line**

Command	Instance	Parameter	Values	Equivalent web parameter
tband	0-3	days	ALL, MF, Mon, Tue, Wed, Thu, Fri, Sat, Sun	Days
tband	0-3	time	HH:MM	Time
tband	0-3	state	off, on	State

Command format

The format for the **tband** command is:

```
tband <instance> <days#> <days>
tband <instance> <days#> <days>
tband <instance> <time#> <time>
tband <instance> <state#> <on|off>
```

To specify multiple days, separate the days with a comma, such as **Mon,Wed,Fri**. You can use the abbreviation **MF** to specify Monday through Friday. For example, to allow PPP routing only on weekdays between **9:00 AM** and **5:30 PM**, enter these commands:

```
tband 0 days 0 mf
tband 0 time0 9
tband 0 state0 on
tband 0 days1 mf
tband 0 time1 5:30
tband 0 state1 off
```

Enable and disable time bands for a PPP or Wi-Fi interface

Web

1. Go to **Configuration > Network > Timebands**. Enabling and disabling time bands for a particular PPP or Wi-Fi interface instance is controlled by the settings in a table with the following columns:

Timebands

Enable Timebands on the following PPP interfaces

Interface	Enable	Timeband
PPP 0	<input type="checkbox"/>	0 ▼
PPP 1	<input type="checkbox"/>	0 ▼
PPP 2	<input type="checkbox"/>	0 ▼
PPP 3	<input type="checkbox"/>	0 ▼
PPP 4	<input type="checkbox"/>	0 ▼
PPP 5	<input type="checkbox"/>	0 ▼
PPP 6	<input type="checkbox"/>	0 ▼
PPP 7	<input type="checkbox"/>	0 ▼
PPP 8	<input type="checkbox"/>	0 ▼
PPP 9	<input type="checkbox"/>	0 ▼
PPP 10	<input type="checkbox"/>	0 ▼
PPP 11	<input type="checkbox"/>	0 ▼
PPP 12	<input type="checkbox"/>	0 ▼
PPP 13	<input type="checkbox"/>	0 ▼
PPP 14	<input type="checkbox"/>	0 ▼
PPP 15	<input type="checkbox"/>	0 ▼
PPP 16	<input type="checkbox"/>	0 ▼
PPP 17	<input type="checkbox"/>	0 ▼
PPP 18	<input type="checkbox"/>	0 ▼
PPP 19	<input type="checkbox"/>	0 ▼

Enable Timebands on the following Wi-Fi interfaces

Interface	Enable	Timeband
Wi-Fi 0	<input type="checkbox"/>	0 ▼
Wi-Fi 1	<input type="checkbox"/>	0 ▼
Wi-Fi 2	<input type="checkbox"/>	0 ▼
Wi-Fi 3	<input type="checkbox"/>	0 ▼

2. Set the time band parameters as needed

Interface

Lists the available PPP instances.

Enable

This column contains checkboxes; each checkbox controls whether or not time bands are enabled for the PPP instance in the left-hand column of the row. Check the checkbox to enable time bands for the associated PPP instance.

Timeband

Selects which of the four available time band instances should be associated with the PPP instance.

3. Click **Apply**.

Command line

Command	Instance	Parameter	Values	Equivalent web parameter
ppp	n	tband	0-3 The default state of this parameter is blank.	Timeband

Configuring advanced network settings

Configure advanced network settings582

Configure advanced network settings

Configure first settings group

Web

1. Go to **Configuration > Network > Advanced Network Settings**.

Advanced Network Settings

Secondary IP Address:

When connected to a Serial interface using TCP

Advertise an MSS of: bytes

Use a Rx Window size of: bytes

Default SSL version for outgoing connections:

Maximum DNS response cache time: seconds

2. Configure the first group of advanced network parameters as needed:

Secondary IP Address a.b.c.d

An additional IP address to the router that is not associated with any particular interface. The router responds directly to incoming traffic for this address; it does not attempt to onward route any IP packets for this address.

When connected to a Serial interface using TCP

Advertise an MSS of n bytes

The maximum segment size an asynchronous serial port connected to TCP sockets uses or advertises.

Use a Rx Window size of n bytes

The Rx window size an asynchronous serial port connected to TCP sockets uses or advertises.

Default SSL version for outgoing connections

Selects which version of the SSL protocol to use in the **tcpdial** command. The options are:

- **Auto**, which allows the server to select the version.
- **TLSv1 only**
- **SSLv2 only**
- **SSLv3 only**

Some servers are configured to work with a particular version. Unless this version is specifically requested, the connection attempt will fail.

3. Configure socket settings:

Socket Settings

Default source IP address interface:

HTTPS port:

Connect Timeout: seconds

TCP socket inactivity timer: seconds

TCP socket keep-alive: seconds

Default source IP address interface x,y

The values in these two text boxes define the interface (**None, PPP, ETH**) and the instance number of the interface to use as a source address for IP when not using the interface that the socket was created on. The router creates general-purpose sockets automatically when the controlling application requests them, for example, when TPAD calls are made over IP or XOT. Normally, the source address the socket uses is that of the outgoing interface, usually PPP. However, for some applications, such as when setting up a VPN, it may be necessary to specify that the socket uses a different source address such as that of the local Ethernet port. This parameter specifies the interface from which the source address should be derived.

Note Even when this parameter is not configured, the router uses IP address from the interface on which the socket was created. It uses the source address specified in this parameter only if it causes the traffic to match an Eroute and therefore be sent using IPsec or GRE.

HTTPS port

The network port number for the HTTPS network service.

Connect Timeout s seconds

The amount of time after which a TCP socket may remain idle before being closed. If the value is set to **0**, the socket may remain open indefinitely.

TCP socket inactivity timer s seconds

The maximum period of inactivity, in seconds, that can occur before and open TCP/IP socket is closed. The default value is **300** seconds (five minutes), and normally should not need to be changed.

TCP socket keep-alive s seconds

The amount of time, in seconds, between sending keep-alive messages over open TCP connections. The purpose of these messages is to prevent a connection from closing even when no data is being transmitted or received. The default value of this parameter is **0**, which disables keep-alive messages.

4. Configure advanced network XOT settings:

XOT Settings

Default source IP address interface:

NB of XOT listening sockets:

Maximum ACK time for XOT data:

Do not deactivate outgoing XOT sockets when interface disconnects

Default source IP address interface x,y

The values in these two text boxes specify the interface (**None**, **PPP**, **ETH**) and instance number of that interface that IP address that XOT sockets should use instead of the interface that the socket was created on.

Note Even when this parameter is not configured, the router uses the IP address from the interface on which the socket was created. It uses the source address specified in this parameter only if it will cause the traffic to match an Eroute and therefore be sent using IPsec or GRE.

NB of XOT listening sockets

The maximum number of XOT sockets available. Use this setting to reduce the number of XOT sockets in order to free up more general-purpose sockets for other purposes. The default value of **0** enables the maximum number of XOT sockets available.

Maximum ACK time for XOT data

The maximum time allowance for a remote unit to acknowledge TCP data transmitted by a unit's socket. If this timer expires, the socket is aborted. The default value of **0** disables the timer.

Note There is no requirement for the remote unit to acknowledge received data immediately, therefore setting this parameter to too small a value is not recommended. Some stacks delay sending TCP ACKs in order that they can be incorporated with data sent by the application.

Do not deactivate outgoing XOT sockets when interface disconnects

When enabled, this setting sets outgoing XOT sockets not to close when the interface they are using disconnects.

5. Configure backup IP addresses. The Backup IP Addresses section contains a table for specifying alternative IP addresses to use when the router fails when attempting to open a socket. The router uses these addresses only for socket connections that originate from the router. These IP addresses provide back-up for XOT connections, TANS (TPAD answering) connections, or any application in which the router is making outgoing socket connections. When a backup address is in use, the original IP address that failed to open is tested at intervals to check if it has become available again. Additionally, at the end of a session, the router remembers when an IP address has failed, and uses the backup address immediately for future connections. When the original IP address becomes available again, the router automatically detects this, and reverts to using that IP address. The **Backup IP Addresses** table has the following column headings:

Backup IP Addresses

IP Address	Backup IP Address	Retry Time (seconds)	Try Next
No Backup IP addresses have been configured			
<input type="text"/>	<input type="text"/>	<input type="text" value="0"/>	<input type="checkbox"/>
			<input type="button" value="Add"/>

Send "Backup IP" system messages to IP Address:

IP Address a.b.c.d

The original IP address to which the back-up address relates.

Backup IP address a.b.c.d

The backup address to try when the router fails to open a connection to the previous IP address.

Retry Time s (seconds)

The length of time, in seconds, the router waits between checks to see if a connection can be made to IP Address.

Try Next

When connection to the primary IP address has just failed, this text box determines whether a connection to the backup IP address should be attempted immediately or when the application next attempts to open a connection. When checked, the socket attempts to connect to the backup IP address immediately after the connection to the primary IP address failed and before reporting this failure to the calling application, such as TPAD. If the backup is successful, the application will not experience any kind of failure, even though the router has connected to the backup IP address. When unchecked, the socket reports the failure to connect back to the calling application immediately after the connection to the primary IP address has failed. The router does not try to connect to the backup IP address at this stage. The next time that the application attempts to connect to the same IP address, the router instead automatically connects to the backup IP address. Use the **Add** and **Delete** buttons to add and delete entries to and from the table.

Add button

Adds the backup IP address settings to the network configuration.

Send "Backup IP" system messages to IP Address: a.b.c.d

The destination IP address to which system messages notifying of the unavailability of an IP address should be sent. This allows the router to send UDP messages to other routers to notify them that an IP address has become available/unavailable. Devices that receive the IP address available/unavailable messages search their own backup IP address tables for the IP addresses indicated, and tag those addresses as available/unavailable as appropriate.

Chaining backup IP addresses

It is possible to chain backup IP addresses by making multiple entries in the table.

For example, if the backup IP address for the original IP address appears as the IP address in the next row, along with a new backup IP address for that IP address. When the original IP

address becomes unavailable, the router tries the backup IP address. If that IP address is unavailable, the router tries its backup IP address, and so on.

For example, if the original IP address is **192.168.0.1** with a backup IP address of **192.168.0.2**, setting the IP address in the next row to **192.168.0.2** with a backup IP address of **192.168.0.3** causes the router to try all these IP addresses in succession.

Note The time that it takes for a connection to an IP address to fail is determined by the **Connect Timeout** parameter **Advanced Network Settings > Socket Settings** section.

- Click **Apply**.

Command line

Configure first group of advanced network settings

Command	Instance	Parameter	Values	Equivalent web parameter
cmd	n	sec_ip	Valid IP address	Secondary IP address a.b.c.d
sockopt	n	asymss	0-2147483648	When connected to a serial interface using TCP Advertise an MSS of n bytes
sockopt	n	asyrxwin	0-2147483648	Use a Rx Window size of n bytes
sockopt	n	sslver	0-3 0=Auto 1=TLSv1 2=SSLv2	Default SSL version for outgoing connections

Configure socket settings

Command	Instance	Parameter	Values	Equivalent web parameter
sockopt	n	gp_ipent	0,PPP,ETH	Default source IP address interface x,y
sockopt	n	gp_ipadd	Valid interface number	Default source IP address interface x,y
sockopt	n	sock_connto	0-2147483648	Connect Timeout s seconds
sockopt	n	sock_inact	0-2147483648	TCP socket inactivity timer s seconds
sockopt	n	sock_keepact	0-2147483648	TCP socket keep-alive s seconds

Configure advanced network XOT settings

Command	Instance	Parameter	Values	Equivalent web parameter
sockopt	n	xot_ipent	Valid interface type, ETH, PPP	Default source IP address interface x,y
sockopt	n	xot_ipadd	Valid interface number	Default source IP address interface x,y
sockopt	n	xot_listens	0-2147483648	NB of XOT listening sockets
sockopt	n	xot_maxack	0-2147483648	Maximum ACK time for XOT data

Configure a backup IP address

Command	Instance	Parameter	Values	Equivalent web parameter
ipbu	n	IPaddr	Valid IP address a.b.c.d	IP Address a.b.c.d
ipbu	n	BUIPaddr	Valid IP address a.b.c.d	Backup IP Address a.b.c.d
ipbu	n	retrysec	0-2147483648	Retry Time s (seconds)
ipbu	n	donext	off, on	Try Next
sarsys	0	dest	Valid IP address a.b.c.d	Send Backup IP system messages to IP address a.b.c.d

Configuring legacy protocols

About legacy protocols	589
Configure Systems Network Architecture over IP (SNAIP)	590
Configure TPAD parameters	598
Configure X.25 parameters	612
Configure a MODBUS gateway	656
Configure Protocol Switch software	660

About legacy protocols

Older protocols that existed before TCP/IP became dominant are often referred to as legacy protocols. Examples of legacy protocols are X.25, SNA and LAPB.

Digi TransPort routers can connect to legacy networks such as X.25. They can also simulate a legacy network so that equipment that, in the past, would have connected to a legacy network, can connect to the Digi TransPort router instead. This means old equipment can be connected to modern networks such as HSUPA.

Configure Systems Network Architecture over IP (SNAIP)

Digi TransPort routers can send Systems Network Architecture (SNA) traffic over TCP/IP, using the DLSw protocol, often called SNAIP. They can also send HDLC traffic over TCP/IP.

SNA uses Synchronous Data Link Control (SDLC), an unbalanced mode in which there is one master station and one or more secondary stations. Each secondary station owns a station address and can only respond when this address has just been polled by the master. A typical scenario is shown in the diagram below:

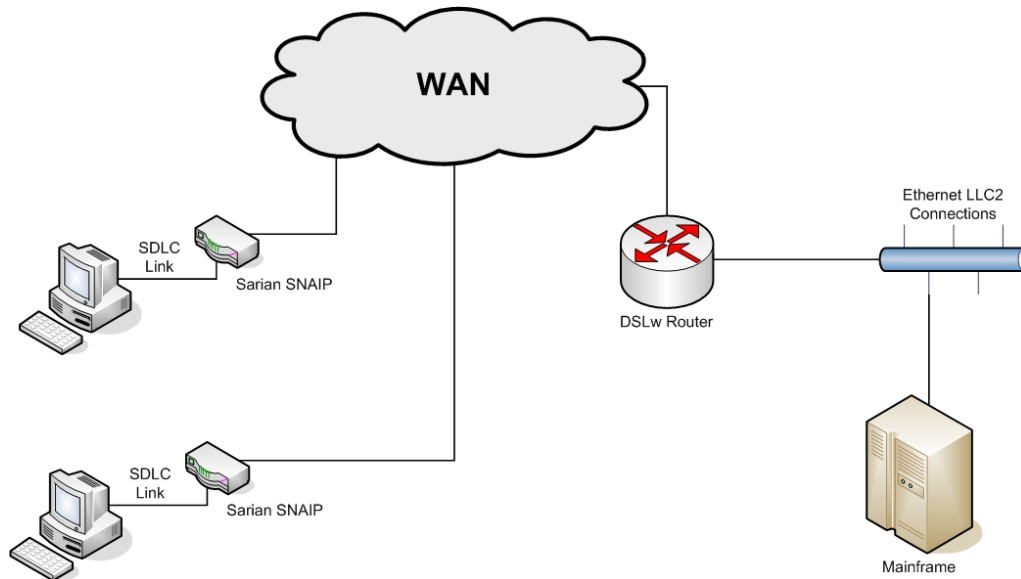

Web

1. Go to **Configuration > Network > Legacy Protocols > SNAIP**.
2. Set SNAIP parameters:

Description

A name for this SNAIP instance, to make it easier to identify.

Send SNAIP traffic over interface

The physical interface for carrying SNAIP data. This can be set to either **ISDN**, **Serial Port**, or **SharedPort**.

- If **ISDN** is selected, SNAIP data is carried over the ISDN BRI physical interface.
- If **Serial Port is selected**, SNAIP data can be routed to either serial **Port 0** or serial **Port 1** (operating in synchronous mode). To configure **Port 0** or **Port 1** for synchronous operation go to **Configuration > Network > Interfaces > Serial > Serial Port x > Sync Port x**.

- If **Shared Port** is selected, the drop down list next to Shared Port specifies the SNAIP instance that has sync port configured. When sync port sharing is enabled only one SNAIP instance can currently own the sync port. Other SNAIP instances however can share this sync port in the event that there is more than one terminal residing on a multi-drop sync line. In this situation with multiple terminals, each terminal station will operate a DLSw state independently of all other stations.

The SNAIP parameter **Priority** is the SNAIP instance to use when more than one is available; the highest number being given preference.

For example, consider that 4 SNAIP instances to all share sync port **0**. To do this, configure **SNAIP 0** in the usual way on **PORT 0**, then configure SNAIP instances **1**, **2**, and **3** to use **SharedPort** and Sync Port from **SNAIP0**.

Use protocol

The protocol for the interface. Choose LAPB, SNA for SDLC or RAW for raw mode in which all L2 frames are transmitted and received. You can also choose RAW_NOHDR for raw mode with no DLSw headers.

Allow this unit to answer calls

This setting is only relevant when the interface is set to ISDN. If this parameter is set to On, the router answers incoming calls on the relevant LAPB session. To prevent the router from answering incoming calls on this LAPB session set the option to Off.

Only accept calls with MSN ending with

This setting is only relevant when the interface is set to ISDN. This is the filter for the ISDN Multiple Subscriber Numbering facility. By default, this setting is blank. When set to an appropriate value with answering calls parameter above enabled, the router to answer incoming calls only to ISDN numbers where the trailing digits of the called number match the MSN value. For example, setting the MSN parameter to **123** prevents the router from answering any calls to numbers that do not end in **123**.

Only accept calls with sub-address ending with

This setting is only relevant when the interface is set to ISDN. This is the filter for the ISDN sub-addressing facility. By default, this setting is blank. When set to an appropriate value, with answering calls parameter above enabled, the router answers incoming ISDN calls only where the trailing digits of the sub address called match the sub-address value. For example, setting the Sub-address to **123** prevents the router from answering any calls where the sub-address called does not end in **123**.

Assume station exists (Do not send TEST frames)

When this parameter is enabled, **TEST** frames are not transmitted and the **TEST** response is not expected. Instead, the router assumes the station exists and proceeds with the protocol as if the DLSw has received the **TEST** response.

Toggle DCD output each time the DLSw protocol enters the DISCONNECTED state

When this parameter is set to **On**, the **DCD** (Data Carrier Detect) output turns off briefly each time the DLSw protocol enters the **DISCONNECTED** state. Any attached equipment that needs

to will see signals changing state.

Sync port should not send or receive data when WAN link is down

Causes the **Sync** port to be deaf and dumb (and have **DCD** low) while the connection with the WAN is down. This setting is supported to prevent terminals from assuming if L2 is up, the rest of the WAN link should be working, at which point the router could go into a management error state.

3. Configure SNA parameters

Router to be Master on an unbalanced link

Enable this parameter if this router is to be the master in an unbalanced link, or set to **Off** if the router is to be a secondary station.

Polling Response Time

The poll time, in milliseconds, if the router is the master in an unbalanced link.

Polling Stations Addresses

This parameter is only applicable in SNA mode. Lists the station addresses on the data link as a comma-separated list of hex values, such as **c1,d1** for station addresses **0xc1** and **0xd1**.

SAPs

A list of SAP values which correspond to the station addresses.

DSAPs(blank=default)

The Destination SAP value, if left blank the router uses the SAP value specified above.

Send Null XID (XID with no Data)

When this parameter is set to **On**, a null XID SSP message will be sent when the router has just received or sent a **REACH ACK** SSP message.

Send XID with Data

A hex string to define binary data and defines an XID SSP message that would be sent in response to a **XIDFRAME** SSP message being received.

Tx Turn Around Time

The time, in milliseconds, between receiving a frame from an outstation and transmission back to the same station. If this parameter is set to **0**, this is disabled and the router can respond immediately. The minimum non-zero value is **10ms**.

Mode

Defines the mode in balanced links, such as HDLC. In unbalanced links such as SNA/SDLC, the mode is defined by being master or the station.

N400 counter

A standard LAPB retry counter. The default value is **3**. Normally it is not necessary to change this parameter.

RR Timer

A standard LAPB/LAPD **Receiver Ready** timer. The default value is **10,000ms (10 seconds)**. Normally it is not necessary to change this parameter.

T1 timer

A standard LAPB timer. The default value is **1000 milliseconds (1 second)**. Normally it is not necessary to change this parameter.

T200 timer

A standard LAPB re-transmit timer. The default value is **1000 milliseconds (1 second)**. Normally it is not necessary to change this parameter.

Window Size

The X.25 window size. The value range is from **1** to **7** with the default being **7**.

Disconnect link if there has been no activity for x seconds

The length of time, in seconds, before the link is disconnected if there has been no activity. If this parameter is **0** or not specified, the inactivity timer is disabled. When the router uses a LAPB instance over ISDN, it is useful to set this to a short period of time, for example, **120** seconds. You can use this timer as a backup hang-up timer, thereby saving ISDN call charges. When using LAPB on a synchronous port, you should normally set this parameter to **0**.

4. Configure SSP (WAN) parameters**Virtual MAC Address**

Virtual MAC address. The host uses MAC addresses and SAP values as the addressing values to discriminate between circuits, in much the same way as an IP address & TCP port define an addressing point for a TCP socket. This is the MAC address reported as part of the DLSw protocol.

Virtual MAC Address of Peer

The Virtual MAC address of the peer.

IP address of the Peer DLSw unit

The IP address of the peer DLSw unit.

Listen on Port

The read IP port. The TCP socket SNAIP listens on.

Use Port x if this unit starts the DLSw protocol

The write IP port. This TCP socket will be opened by the router if it needs to start the DLSw protocol.

Use interface for source IP address

Setting this parameter to a **PPP** or **ETH** instance causes the source address for this SNAIP instance to match that of the Ethernet or PPP interface specified.

Close TCP connection if it is idle for x secs

The maximum period of inactivity (in seconds) that may occur before an open TCP/ IP socket is closed. The default value is **300** seconds (**5** minutes). Normally it is not necessary to change this parameter.

DLSw Ver

The DLSw version to use. Set to **0** (default) for version 1, set to **2** for version 2.

DLSw Role

When this parameter is set to **Active**, and the router is in SNA mode, this DLSw switch actively connects to the remote DLSw switch.

DLSw Window

The DLSw window size. The value range is from **10** to **100**. The default is **20**.

UDP Capable

Controls the UDP transmission of DLSw SSP packets. Reception is always enabled for version 2 support. If set to **OFF**, the state transitions occur like DLSw version 1, but the router indicates it is version 2-capable.

Use 1 socket

When this parameter is set to **On**, the router uses only one socket for both read and write data. This is useful if the router is behind a NAT box and incoming connections are not possible. This parameter can also be set to **Compatible**, in which mode both sockets are open to start with and then after a negotiation one of the sockets is dropped.

Include MAC Exclusivity Capability

On or **Off**. Set this parameter to **On** to include the MAC exclusivity value in the capabilities exchange message.

MAC Exclusivity Value

See above.

Ignore unsolicited response frames

When enabled, the router ignores unsolicited response frames.

Wait for Contact before progressing to CONNECT PENDING state

During the DLSw negotiation phase and when XID messages are being exchanged, this parameter controls which end sends the **CONTACT** message. Normally this would be off in which case this router would send the **CONTACT** message, but if this parameter is set, we

would not send this message, but instead wait for it to be sent to us before progressing in the DLSw state machine.

Make immediate connection attempts before backing off

The number of successive connection attempts before backing off for the number of seconds (default **30**) defined in the **Backoff for x seconds...** parameter. This backoff might be necessary when a server is behind a firewalls that detects too many successive connection attempts in a certain time frame.

Backoff for x seconds before attempting to connect again

When backing off because of too many failed consecutive connection attempts, this parameter defines the time, in seconds, the router should remain idle before attempting another connection.

5. Click **Apply**.

Command line

Command	Instance	Parameter	Values	Equivalent web parameter
snaip	x	l1iface	ISDN, Port, SharedPort	Send SNAIP traffic over interface.
snaip	x	l1nb	0-255 (Select LAPB, Port or SharePort instance)	Send SNAIP traffic over interface.
snaip	x	protocol	LAPB, SNA, RAW, RAW_NOHDR	Use the specified protocol.
snaip	x	ans	1=enabled, 0=disabled	Allow this unit to answer calls.
snaip	x	msn	text	Only accept calls with MSN ending with the specified text.
snaip	x	sub	text	Only accept calls with sub-address ending with the specified text.
snaip	x	autocontact	1=enabled, 0=disabled	Assume station exists. (Do not send TEST frames).
snaip	x	dcd_toggle	1=enabled, 0=disabled	Toggle DCD output each time the DLSw protocol enters the DISCONNECTED state.
snaip	x	l1oos	1=enabled, 0=disabled	Sync port should not send or receive data when WAN link is down.
snaip	x	master	1=enabled, 0=disabled	Router to be Master on an unbalanced link.
snaip	x	pollresp	0-2147483647	Polling Response Time.

Command	Instance	Parameter	Values	Equivalent web parameter
snaip	x	stations	text	Polling Stations Addresses.
snaip	x	saps	text	SAPs.
snaip	x	dsaps	text	DSAPs(blank=default).
snaip	x	send_xid_null	1=enabled, 0=disabled	Send Null XID (XID with no Data).
snaip	x	xid_data	text	Send XID with Data.
snaip	x	turntxtim	0-2147483647	Tx Turn Around Time.
snaip	x	dtemode	1=DTE, 0=DCD	Mode.
snaip	x	n400	0-255	N400 counter.
snaip	x	tnoact	1000-60000	RR Timer.
snaip	x	t1time	1-60000	T1 timer.
snaip	x	t200	1-60000	T200 timer.
snaip	x	window	1-7	Window Size.
snaip	x	tinact	0-3000	Disconnect link if there has been no activity for x seconds.
snaip	x	vmac	Text (valid MAC address)	Virtual MAC Address.
snaip	x	peervmac	Text (valid MAC address)	Virtual MAC Address of Peer.
snaip	x	IPaddr	Text (valid IP address)	IP address of the Peer DLSw unit.
snaip	x	r_IPport	0-65535	Listen on Port.
snaip	x	w_IPport	0-65535	Use Port x if this unit starts the DLSw protocol.
snaip	X	srcipent	auto, eth, ppp	Use interface for source IP address.
snaip	x	srcipadd	0-255	Use interface for source IP address.
snaip	x	sock_inact	0-2147483647	Close TCP connection if it is idle for x secs.
snaip	x	ver	0-2	DLSw Ver.
snaip	x	passive	0= active 1=passive	DLSw Role.
snaip	x	dlswwindow	1-100	DLSw Window.
snaip	x	udp_cap	1=enabled 0=disabled	UDP Capable.

Command	Instance	Parameter	Values	Equivalent web parameter
snaip	x	use1sock	On, Off, Compatible	Use 1 socket.
snaip	x	inc_mac_exc	1=enabled 0=disabled	Include MAC Exclusivity Capability.
snaip	x	mac_exc_val	0-1	Mac Exclusivity Value.
snaip	x	iunsolresp	1=enabled 0=disabled	Ignore unsolicited response frames.
snaip	x	waitforcontact	1=enabled 0=disabled	Wait for Contact before progressing to CONNECT PENDING state.
snaip	x	con_attempts	0-2147483647	Make immediate connection attempts before backing off
snaip	x	con_boff_time	0-2147483647	Backoff for x seconds before attempting to connect again

Forcing SNAIP to use a specific instance

If several SNAIP instances share an ASY port, a switchover to a specific instance can be initiated by issuing **snasw x**, where **x** is the SNAIP instance number. This instance must be available to go online, or this command will fail.

To revert back and use the default instance, issue the **snadis x** command. The router uses normal priorities to determine which SNAIP instance gets to use the SYNC port.

Configure TPAD parameters

TPAD is a simplified version of the X.25 PAD specification. A common use of TPAD is to conduct credit-card clearance transactions. Digi routers support the use of TPAD over ISDN B and D-channels, TCP, UDP, SSL, and XoT. Automatic back-up between any two of these “layer 2 interfaces” or “transport protocols” is supported.

Web

1. Go to **Configuration > Network > Legacy Protocols > TPAD > TPAD n.**

TPAD 0

Use TPAD over interface LAPD (X.25 over ISDN D-channel)

LAPB (X.25 over ISDN B-channel)

XOT (X.25 over TCP)

TCP

UDP

SSL XOT

SSL

Use backup interface

LAPD (X.25 over ISDN D-channel)

LAPB (X.25 over ISDN B-channel)

XOT (X.25 over TCP)

TCP

UDP

SSL XOT

SSL

2. Set TPAD parameters:

Use TPAD over interface

Selects whether the TPAD instance will use ISDN B-channel X.25, ISDN D-channel X.25, TCP, VXN or SSL as the transport protocol. For ISDN D-channel operation, select **LAPD** option. For ISDN B-channel operation or operation through a synchronous port, select **LAPB**. In the case of LAPB and LAPD an interface number can also be specified. This parameter specifies which LAPB or LAPD instance to use for the relevant TPAD instance. Select **0** or **1** for LAPB. or **0** or **1** for LAPD. When using LAPB with ISDN, this parameter may be set to **255**, which means use any free LAPB instance. This is useful when more than 2 POS terminals are connected to the router and the acquirer does not support multiple Switched Virtual Circuits (SVCs) on a single B-Channel. A value of **254** uses an available LAPB instance, but will use the same ISDN B channel if two calls are attempted to the same ISDN number at the same time. (All services that the POS terminals may dial must support multiple SVCs if using the setting **254**.)

Use backup interface

Specifies a backup interface to use automatically if the call to the primary interface fails. Note that the primary interface will be tried first for every new call attempt.

3. Set ISDN parameters:

ISDN settings

Use number: to make outgoing ISDN calls

Use prefix:

Remove prefix: from number in ATD command

Use suffix:

On the main interface

Deactivate LAPB session seconds after TPAD X.25 call has been cleared

On the backup interface

Deactivate LAPB session seconds after TPAD X.25 call has been cleared

Use number x to make outgoing ISDN calls

Used to specify an ISDN number. Use when no ISDN number is provided with the **ATD** command when making an outgoing call.

Use prefix x

A dialing code the router places in front of the telephone number that is issued by the terminal in the ATD command. For example, if the **Use Prefix** setting is set to **0800** and the number specified by the terminal in the **ATD** command is **123456**, the actual number dialed by the router is **0800123456**.

Remove prefix x from number in ATD command

A dialing prefix that is normally inserted by the terminal in the ATD command that is removed by the router before dialing takes place. For example, if the **Remove prefix** setting is set to **0800** and the terminal issued an **ATD** command containing **0800123456**, the actual number dialed by the router is **123456**.

Use suffix x

The Suffix # parameter may be set to contain additional numbers that are dialed after the number specified by B-channel ISDN #. For example, if B-channel ISDN # is set to **123456** and Suffix # is set to **789**, the actual number dialed is **123456789**.

On the main interface**Deactivate LAPB session x seconds after TPAD X.25 call has been cleared**

Once a TPAD X.25 call has been cleared, the router keeps a LAPB instance active for the length of time set by this parameter. This allows further TPAD transactions to occur without having to make another ISDN call. The default value of **10** seconds is acceptable for most applications. The value of **1** is a special value which means terminate Layer 2 immediately the transaction is finished. (When the X.25 call is cleared.) If you select LAPD as the TPAD Layer-2 interface, this value is automatically be set to **0** to disable Layer-2 deactivation. You can override the **0** setting by entering a new value, but most network service providers prefer that LAPD connections are not repeatedly deactivated.

On the backup interface**Deactivate LAPB session x seconds after TPAD X.25 call has been cleared.**

Equivalent to the deactivation timer above, but applies only to backup calls.

4. Set X.25 parameters:

X.25 settings

Default X.25 Packet Size:

When making an outgoing X.25 call

Use NUA:

Use NUI:

LCN:

LCN direction:

On the backup interface

Use NUA:

Use NUI:

LCN:

LCN direction:

Report our NUA as to the X.25 network

Send X.25 RESTART packets

Delay the X.25 RESTART packets by milliseconds

Call User Data

Allow per X.25 call

Use ASCII character as the delimiter character

Forward mode time: milliseconds

Create an event when reply from X.25 host matches

When making an outgoing X.25 call**Default X.25 Packet Size**

The default X.25 packet size for TPAD transactions.

Use NUA

The X.25 Network User Address for outgoing X.25 calls if no NUA is specified in the call string.

Use NUI

The X.25 Network User Identifier for outgoing X.25 calls if no NUI is specified in the call string.

LCN

The router supports up to eight logical X.25/TPAD channels. In practice, the operational limit is determined by the particular service to which you subscribe (usually 4). Each logical channel must be assigned a valid Logical Channel Number (LCN). The LCN parameter is the value of the first LCN that will be assigned for outgoing X.25 CALLs. The default is **1027**. For incoming calls, the router accepts the LCN specified by the caller.

LCN direction

Specifies whether the X.25 LCN for outgoing TPAD calls is incremented or decremented from the starting value when multiple TPAD instances share one layer 2 (LAPB or LAPD), connection. The default is **DOWN** and LCNs are decremented, such as if the first CALL uses **1024**, the next

will use **1023**, etc. Setting the parameter to **UP** causes the LCN to be incremented from the start value.

On the backup interface

Use NUA

Sets the first LCN for the backup interface.

Use NUI

The X.25 Network User Identifier to use for outgoing X.25 calls if no NUI is specified in the call string for the backup interface.

LCN

The first LCN for the backup interface.

LCN direction

Determines whether the LCN for the backup X.25 interface is incremented or decremented from the starting value when multiple X.25 instances share a single Layer 2 connection.

Report our NUA as n to the X.25 network

The NUA that the router will report to the X.25 network as its own NUA when making a call. It is also known as the calling NUA. Often the X.25 network will override this NUA.

Send X.25 RESTART packets

Sends X.25 RESTART packets.

Delay the X.25 RESTART packets by x milliseconds

The time, in milliseconds, to wait before sending the X.25 RESTART packets.

Call User Data

A text string that will be placed in the Call User Data field of an outgoing X.25 call request packet. Whether or not this information is required will depend on the X.25 host that you are connecting to. In most cases the information is not required.

X.25 calls

These setting control how transactions are sent to the host when TPAD is running in direct mode.

One per transaction

Only one transaction is allowed per call.

Allow consecutive transactions

Multiple transactions are allowed per X.25 call, but not until a response has been received from the host.

Allow concurrent transactions

Multiple transactions per X.25 call are allowed irrespective of whether a response has been received from the host.

Use ASCII character *x* as the delimiter character

The character for separating a main NUA from a backup NUA, and a main NUI from a backup NUI in an **ATD** command. The default value is the ASCII **!** character (decimal 33).

Forward mode time *x* milliseconds

If not framed with STX and ETX characters, can still have data formatted after this period.

Create an event when reply from X.25 host matches

Used to generate a data trigger event (code 47) when the reply from the X.25 host contains the string specified in this parameter. You can configure the router to generate an email alert message when this event occurs. See file **LOGCODES.TXT** for a complete list of events.

XoT/TCP settings**Connect to remote IP address**

When the router is configured for XOT or TCP socket mode, this parameter sets the IP address of the host to which the TCP/XOT connection is made. The transport protocol must be set to TCP.

Port

When making a TCP socket connection (such as the transport protocol has been set to **TCP** not **XoT**), this parameter sets the TCP port number to use.

IP length header

When making a TCP socket connection (such as the transport protocol has been set to TCP), setting this parameter to **On** will prepend the data sent to the host with a 2-byte length header. The 2-byte length header is not included in the length calculation. When set to **8583 Ascii 4 byte**, the IP length header conforms to the ISO 8583 format. Setting this parameter to **On Inclusive** prepends a 2-byte length header, and the calculation of the length includes the 2 bytes of the length header.

Set TPAD parameters:

TPAD settings

Use Terminal ID (TID):

Replace TID provided by connected terminal with configured TID

The TID will be become inactive in seconds

Use TID with incoming APACS 50 polling calls

Use merchant Number:

Use Connect String:

The polling character set is

Enable Message Numbering

Disable Direct Mode

Boot to Direct Mode

Use response code in "unable to authorise" message

Clearing time milliseconds

Delay transmitting the APACS 30 string for milliseconds after connecting to X.25 host

Retransmit APACS 30 string if error detected

STX/ETX removal OFF Del STX&ETX Del STX only

Do not transmit ENQ characters

Delay sending ENQ characters to TPAD terminal for milliseconds when a call has been connected

Wait for milliseconds for an ACK before retransmitting the data

Include LRC

Include LRC line

Force parity when sending data to the terminal

Strip parity when sending data to the host

Force parity when sending data to the host

Strip Trailing Spaces

Acknowledge TPAD data packets

Convert leading STX character to SOH

Terminate TPAD call using EOT only

Clear TPAD call if there is no reponse to a TPAD transaction request for seconds

Generate an event when a TPAD transaction takes longer than seconds

When the transaction time exceeds milliseconds, increment the "SLA Exceptions" statistic.

Clear the call seconds after receiving a response

If the terminal dial command specifies V.120 use PANS context

Use Terminal ID (TID)

Inserts or replaces a Terminal ID in the APACS 30 string.

Replace TID provided by connected terminal with configured TID

When enabled, any Terminal ID provided by a connected terminal is replaced by the ID set in the **Use Terminal ID** field above.

The TID will become inactive in n seconds.

The time, in seconds, before the Terminal ID is considered inactive. Local authorizations may be configured to occur on active TIDs (terminal IDs), so this parameter defines how long a time (without transactions) must pass for a TID to change from active to inactive.

Use TID xxxxxxxxx with incoming APACS 50 polling calls

The terminal ID to associate with this TPAD instance when answering an incoming APACS 50 polling call.

Use merchant Number

Inserts a merchant number into the APACS 30 string when the locally connected equipment does not transmit a merchant number.

Use Connect String

A string sent to the user's terminal when an outgoing TPAD call has been connected, instead of the normal ENQ character. For example, you could use this setting to make a TPAD connection look like a PAD connection by specifying **CON COM** as the connect string.

The polling character set is c

A string that specifies a character or set of characters to be treated as polling characters. The router responds to any of these characters using ACK. This parameter should normally be left blank.

Enable Message Numbering

When enabled, the router overrides the message numbering of the local equipment and substitute its own message numbering in the APACS 30 data. This is useful when the locally connected equipment does not automatically increment the APACS 30 message number.

Disable Direct Mode

Enabling this setting will prevent the router from automatically using Direct Mode (see below) when it receives an APACS 30 packet without any call set-up.

Boot to Direct Mode

Direct mode is a mode of operation whereby the router automatically routes APACS 30 packets to their destination without the terminal having to perform any call control. If this parameter is set to **Yes**, the next time the router is rebooted, it operates in direct mode. For direct mode to work you must set up the appropriate addressing information, such as Transport protocol, NUA, NUI, IP address etc. If this parameter is not enabled, the router still tries to use direct mode if it detects that it is required, due to the absence of call control information. Use this parameter when the router cannot automatically determine whether or not to use direct mode.

Use response code n in "unable to authorize" message

This parameter only applies when the router is operating in direct mode. In cases where the router is unable to send the APACS 30 packet to the remote host, it replies to the terminal with an unable to authorize message. By default, this message contains a response code **05**, which

means declined. Entering a number for this parameter causes the router to use that number in place of the default response code. A value of **0** prevents the router from replying.

Clearing time *n* milliseconds

The clearing time, in milliseconds, that an X.25 call is left open after receiving a response from the host. Each response from the host resets this timer.

Delay transmitting the APACS 30 string for *x* milliseconds after connecting to X.25 host

Setting this parameter causes the router to pause for the specified number of milliseconds in between successfully connecting to the remote X.25 host and transmitting the APACS 30 string.

Retransmit APACS 30 string if error detected

Enabling this setting causes the router to retransmit the APACS 30 string to the terminal if an error is detected, such as no ACK received from terminal.

STX/ETX removal

Enabling **Del STX&ETX** causes the router to strip off the **STX** and **ETX** characters that normally surround the APACS 30 string before sending it to the host. Enabling **Del STX only** causes the router to strip the **STX** character only.

Do not transmit ENQ characters

The TPAD protocol normally uses the **ENQ** character to indicate that a call has connected and that the TPAD terminal may proceed with the transaction. Enabling this parameter prevents the router from transmitting **ENQ** characters to the TPAD terminal when a connection is made.

Delay sending ENQ characters to TPAD terminal for *x* milliseconds when a call has been connected

Set s the delay, in milliseconds, from when the router first connects the call to when it transmits the ENQ to the terminal. By default, there is no delay.

Wait for *x* milliseconds for an ACK before retransmitting the data

The time the router waits for an ACK character to be received after sending data to the terminal. If an ACK character is not received within this time, the data is retransmitted. A value of **0** sets a delay of **1 second** (the default).

Transmit TPAD transactions directly in a Synchronous frame

If enabled, TPAD transactions are transmitted without any outer protocol, such as X.25, such as they are placed directly in a synchronous frame on ISDN. This sometimes referred to as HDLC by certain card acquirers.

Include LRC

The LRC (Longitudinal Redundancy Check) is a form of error checking that may be required by some TPAD terminals. When the Include LRC option is enabled the router will check the LRC sent by the terminal and if it indicates a problem has occurred NAK the message. If this

parameter is enabled but no LRC is sent by the terminal, the transaction is not forwarded to the host.

Include LRC line

This parameter is normally disabled so that any LRCs received from a TPAD terminal will be removed before the transaction data is transmitted to the remote host. In most cases this is acceptable because the network will provide error correction and so the LRC is redundant. In some circumstances it may be necessary to enable this parameter so that the router transmits the LRC to the remote host along with the transaction data.

Force parity when sending data to the terminal

If enabled, the router always uses even parity when relaying data from a remote host to a locally connected TPAD terminal. To allow data to pass through without the parity being changed, disable this setting.

Strip parity when sending data to the host

Enabling this parameter causes the router to remove any parity before sending the data to the host.

Force parity when sending data to the host

If enabled, the router always uses EVEN parity when relaying data from the locally connected TPAD terminal to the remote host. To allow data to pass through without the parity being changed disable this setting.

Strip Trailing Spaces

If enabled, the TPAD instance looks at responses coming from the host and remove any trailing space characters from the end of the packet before relaying the data to the terminal. This may be necessary if the host system pads out responses with unnecessary spaces which can cause abnormal behavior in some terminals.

Acknowledge TPAD data packets

Causes the router to acknowledge TPAD data packets from the terminal. This parameter should normally be enabled. Use only if no polling characters (see above) are defined.

Convert leading STX character to SOH

If enabled, the router converts the leading STX character in a transaction to an SOH character.

Terminate TPAD call is EOT only

A TPAD call is normally terminated with a DLE EOT sequence. Some terminals only require the EOT character on its own. If this is the case then enable this parameter.

Clear TPAD call if there is no response to a TPAD transaction request for x seconds

The length of time, in seconds, the router waits for a response to a TPAD transaction request before clearing the TPAD call.

Generate an event when a TPAD transaction takes longer than x seconds

Setting this parameter to a non-zero value causes the router to generate an Excessive Transaction Time event (**code 56**) each time a TPAD transaction takes longer than the specified number of seconds. You can use this setting with an appropriate Event Handler configuration to generate email alert messages or SNMP traps when TPAD transactions take longer than expected. See Configuration > Alarms > Event Logcodes for a complete list of events.

When the transaction time exceeds x milliseconds, increment the “SLA Exceptions” statistic

When the total transaction time exceeds the value (in ms) set in this parameter, the NB SLA exceptions statistic on the Diagnostics - Statistics > TPAD page is incremented. This statistic can be viewed on the CLI interface by entering the `at\mibs=tpad.n.stats` command, where **n** is the TPAD instance.

Clear the call x seconds after receiving a response

The time period for which the socket closing or the X.25 call clearing is delayed by after the TPAD session has finished. For example, if this parameter is set to **10**, then 10 seconds after the TPAD session is finished (**NO CARRIER** is seen on the ASY TPAD port) the network call (X25 or TCP socket) is cleared. The number **1** is a special value. If set to the number **1**, the call is cleared immediately, instead of after 1 second.

If the terminal dial command specifies V.120 use PANS context x

This parameter is for advanced users only. It enables TPAD transactions to be carried out using the V.120 protocol (**ATDV** command). Use this parameter with the Polling Answering Service (PANS). It identifies which PANS instance to use for an outgoing V.120 call. For this to work, the PANS instance must be bound to a Rate Adaption instance.

5. Click **Apply**.

 **Command line**

Command	Instance	Parameter	Values	Equivalent web parameter
tpad	n	l2iface	lapb, lapd, tcp, ssl, vxn	Use TPAD over interface.
tpad	n	l2nb	0-255	Use TPAD over interface.
tpad	n	ipmode		Use TPAD over interface.
tpad	n	bakl2iface	lapb, lapd, tcp, ssl, vxn	Use backup interface.
tpad	n	bakl2nb	0-255	Use backup interface.
tpad	n	bnumber	text (valid ISDN number)	Use number x to make outgoing ISDN calls.
tpad	n	prefix	text (numeric)	Use prefix x

Command	Instance	Parameter	Values	Equivalent web parameter
tpad	n	prefix_rem	text (numeric)	Remove prefix x from number in ATD command.
tpad	n	suffix	text (numeric)	Use suffix x.
tpad	n	tl2deact	0-10000	On the main interface Deactivate LAPB session x seconds after TPAD X.25 call has been cleared.
tpad	n	baktl2deact	0-10000	On the backup interface Deactivate LAPB session x seconds after TPAD X.25 call has been cleared.
tpad	n	defpak	16,32,64,128,256,512,1024	Default X.25 Packet Size.
tpad	n	nua	text	Use NUA.
tpad	n	nui	text	Use NUI.
tpad	n	lcn	1-4095	LCN.
tpad	n	lcnp	1=up, 0=down	LCN direction.
tpad	n	baknua	text	(Backup) Use NUA.
tpad	n	baknui	numeric text	(Backup) Use NUI.
tpad	n	baklcn	1-4095	(Backup) LCN.
tpad	n	baklcnp	1=up, 0=down	(Backup) LCN direction
tpad	n	cingnua	numeric text	Report our NUA as n to the X.25 network.
tpad	n	cu	text	Call User Data.
tpad	n	samecall	0	One per transaction.
tpad	n	samecall	1	Allow consecutive transactions.
tpad	n	samecall	2	Allow concurrent transactions.
tpad	n	delimchar	32-127	Use ASCII character x as the delimiter character.
tpad	n	ftime	0-20000	Forward mode time x milliseconds.
tpad	n	trig_str	text	Create an event when reply from X.25 host matches.

Command	Instance	Parameter	Values	Equivalent web parameter
tpad	n	IPaddr	IP address	Connect to remote IP address.
tpad	n	iphdr	0=Off 1=On 2=8583 Ascii 4 byte	IP length header.
tpad	n	termid	text	Use Terminal ID (TID).
tpad	n	dotermid	1=enabled, 0=disabled	Replace TID provided by connected terminal with configured TID.
tpad	n	tid	text	Use TID xxxxxxxxxx with incoming APACS 50 polling calls.
tpad	n	merchnum	text	Use merchant Number.
tpad	n	useconstr	1=enabled, 0=disabled	Use Connect String.
tpad	n	constr	text	Use Connect String.
tpad	n	pollchars	text	The polling character set is c.
tpad	n	domsgnb	1=enabled, 0=disabled	Enable Message Numbering
tpad	n	disdir	1=enabled, 0=disabled	Disable Direct Mode.
tpad	n	bdir	1=enabled, 0=disabled	Boot to Direct Mode.
tpad	n	uaarc	0-99	Use response code n in unable to authorise message.
tpad	n	clear_ dirtime	0-60000	Clearing time n milliseconds.
tpad	n	trandel	0-5000	Delay transmitting the APACS 30 string for x milliseconds after connecting to X.25 host.
tpad	n	teretran	1=enabled, 0=disabled	Retransmit APACS 30 string if error detected.
tpad	n	delstx	1=enabled, 0=disabled	STX/ETX removal.
tpad	n	no_enq	1=enabled, 0=disabled	Do not transmit ENQ characters.

Command	Instance	Parameter	Values	Equivalent web parameter
tpad	n	tenqdel	0-5000	Delay sending ENQ characters to TPAD terminal for x milliseconds when a call has been connected.
tpad	n	tackdel	0-10000	Wait for x milliseconds for an ACK before retransmitting the data.
tpad	n	dsync	1=enabled, 0=disabled	Transmit TPAD transactions directly in a Synchronous frame.
tpad	n	inclrc	1=enabled, 0=disabled	Include LRC.
tpad	n	incllrc	1=enabled, 0=disabled	Include LRC line.
tpad	n	fpar	1=enabled, 0=disabled	Force parity when sending data to the terminal.
tpad	n	lpar	1=enabled, 0=disabled	Strip parity when sending data to the host.
tpad	n	lpar	1=enabled, 0=disabled	Force parity when sending data to the host.
tpad	n	strip_tspaces	1=enabled, 0=disabled	Strip Trailing Spaces.
tpad	n	ackdat	1=enabled, 0=disabled	Acknowledge TPAD data packets.
tpad	n	stx_2_soh	1=enabled, 0=disabled	Convert leading STX character to SOH .
tpad	n	eot_only	1=enabled, 0=disabled	Terminate TPAD call is EOT only.
tpad	n	tresp	0-1000	Clear TPAD call if there is no response to a TPAD transaction request for x seconds.
tpad	n	texcess	0-100	Generate an event when a TPAD transaction takes longer than x seconds

Command	Instance	Parameter	Values	Equivalent web parameter
tpad	n	tsla	0-3000	When the transaction time exceeds x milliseconds, increment the SLA Exceptionsstatistic.
tpad	n	clear_time	0-2147483647	Clear the call x seconds after receiving a response
tpad	n	dialctx	0-255	If the terminal dial command specifies V.120 use PANS context x.

Configure X.25 parameters

Web

Go to **Configuration > Network > Legacy Protocol > X.25** There are several groups of configuration parameters:

- General
- LAPB
- NUI Mappings
- NUA / NUI Interface Mappings
- Calls Macros
- IP to X.25 Calls
- PADS n
- X.25 Settings
- IP Settings
- PADs
- X.25 PVCs

Configure general X.25 parameters

Web

1. Go to **Configuration > Network > Legacy Protocol > X.25 > General**.

▼ X.25

▼ General

When answering a X.25 call, use the addresses from CALL packet in the CALL CNF packet for

LAPD:

LAPB:

XOT:

Reset XOT PVC if this router is the

Initiator:

Responder:

Include length of header in IP length header

Apply

2. Configures global X.25 parameters:

When answering a X.25 call, use the addresses from CALL packet in the CALL CNF packet

If enabled, when answering a call, the X.25 **CALL CNF** (call confirm packet) that the router sends to answer the call use the called and calling addresses from the CALL packet. You can enable this setting on a per-interface type basis, (LAPD, LAPB, or XoT).

Reset XOT PVC if the router is the Initiator

If enabled, the router is responsible for resetting the links when an XOT PVC comes up. This parameter should only be set to **Off** when it is known that the responder will reset the links.

Reset XOT PVC if the router is the Responder

If set to **On**, the router is responsible for resetting the links on XOT PVC links when it is the responder. The default for this parameter is **Off**.

Include length of header in IP length header

For all X.25 calls that include an IP header length indication, such as IP Length Header is set to **On** a TPAD or PAD, etc, this parameter specifies whether the length indicated includes or excludes the length of the header itself. By default this setting is **Off**, in which case the length of the header is NOT included in the value.

For example, suppose there is one byte of data of value 67 to encode. Then, **00 01 67** is the encoding if this parameter is set to **Off** as the length (**00 01**) is **1**, because the length does not include the length of the header.

When set to **On**, the length of the IP header is included in the value, such as **00 03 67** is the encoding as the header bytes are included.

3. Click **Apply**.

**Command line**

Command	Instance	Parameter	Values	Equivalent web parameter
x25gen	0	lapd_cnf_addr	1=enabled 0=disabled	When answering a X.25 call, use the addresses from CALL packet in the CALL CNF packet. LAPD setting
x25gen	0	lapd_cnf_addr	1=enabled 0=disabled	When answering a X.25 call, use the addresses from CALL packet in the CALL CNF packet LAPB setting
x25gen	0	xot_cnf_addr	1=enabled 0=disabled	When answering a X.25 call, use the addresses from CALL packet in the CALL CNF packet XoT setting
x25gen	0	reset_xotpvc_ini	1=enabled 0=disabled	Reset XOT PVC if the router is the Initiator
x25gen	0	reset_xotpvc_resp	1=enabled 0=disabled	Reset XOT PVC if the router is the Responder
x25gen	0	en_incl_iphdr	1=enabled 0=disabled	Include length of header in IP length header

Configure X.25 LAPB parameters

Link Access Procedure Balanced (LAPB) is a standard subset of the High-Level Data Link Control (HDLC) protocol. It is a bit-oriented, synchronous, link-layer protocol that provides data framing, flow control and error detection and correction. LAPB is the link layer that X.25 applications use. On Digi TransPort routers, you can use LAPB over ISDN or over a synchronous serial port.

Web

1. Go to **Configuration > Network > Legacy Protocol > X.25 > LAPB**.

▼ LAPB

LAPB 0

Mode: DTE DCE

N400 Counter:

RR Timer: milliseconds

T1 Timer: milliseconds

T200 Timer: milliseconds

X.25 Window Size: ▼

Disconnect link if there has been no X.25 activity for seconds

Disconnect link if there has been no activity for seconds

Send X.25 Restart packet on receipt of SABM frame

Keep LAPB link activated when user sends a DISC or X.25 PAD session terminated

Wait milliseconds before attempting to establish the LAPB link after B-channel becoming active

Async Mux 0710 Parameters

Mux 0710 mode:

Mux mode: ▼

DLC #:

ASY port:

Virtual ASY port:

LAPB 1

LAPB 2

LAPB 3

LAPB 4

LAPB 5

LAPB 6

2. Configure LAPB parameters:

Use: Serial port Port x (in Synchronous Mode)

To use the LAPB instance over a synchronous serial port enable this setting and select a serial port number. To configure settings of the synchronous port such as speed and clock source navigate to Configuration > Network > Interfaces > Serial > Serial Port n > Sync Port n.

Use: ISDN

Enable this setting to use LAPB over ISDN.

Mode DTE or DCE

Determines whether LAPB will behave as DTE (Data Terminal Equipment) or DCE (Data Circuit-terminating Equipment) in an X.25 protocol sense. Physical DTE vs. DCE wiring cannot be changed by configuration.

N400 Counter x

This is the standard LAPB retry counter. The default value is **3** and it should not normally need to be changed.

RR Timer x milliseconds

A standard LAPB Receiver Ready timer. The default value is **10,000 milliseconds (10 seconds)** and it should not normally be necessary to change this.

T1 Timer x milliseconds

A standard LAPB timer. The default value is **1000 milliseconds (1 second)** and under normal circumstances, it should not be necessary to change it.

T200 Timer x milliseconds

The standard LAPB re-transmit timer. The default value is **1000 milliseconds (1 second)** and under normal circumstances, it should not be necessary to change it.

X.25 Window Size

The X.25 window size. The value range is from **1** to **7** with the default being **7**.

Disconnect link if there has been no X.25 activity for x seconds

The length of time, in seconds, before the link is disconnected if there has been no X.25 activity. If this parameter is **0** or not specified, then the inactivity timer is disabled.

Disconnect link if there has been no activity for x seconds

The length of time, in seconds, before the link is disconnected if there has been no activity. If this parameter is **0** or not specified, then the inactivity timer is disabled. It is useful to set this to a short period of time, for example, **120** seconds, when using a LAPB instance over ISDN; for example, with TPAD. Should the POS device fail to instruct TPAD to hang up you can use this timer as a backup hang-up timer thus saving ISDN call charges. When using LAPB on a synchronous port, set this parameter to **0**.

Send X.25 Restart packet on receipt of SABM frame

This parameter can be set to **No** or **Immediate**.

- When set to **Immediate**, the LAPB instance sends an X.25 restart packet immediately on receipt of an SABM (Set Asynchronous Balanced Mode) frame.
- If the parameter is set to **No**, no X.25 restart is sent.

ISDN Parameters**Allow this unit to answer calls**

If enabled, this instance of LAPB answers incoming ISDN calls.

Only accept calls from calling number ending with

The filter for the ISDN Multiple Subscriber Numbering facility. It is blank by default. When set to an appropriate value with **Allow this unit to answer calls** enabled, the router answers incoming calls only to ISDN numbers where the trailing digits match the MSN value. For example, setting the MSN parameter to **123** prevents the router from answering any calls to numbers that do not end in **123**.

Only accept calls with sub-address ending with

The filter for the ISDN sub-addressing facility. It is blank by default but when set to an appropriate value, with **Allow this unit to answer calls** enabled, the router answers incoming ISDN calls only where the trailing digits of the sub address called match the Sub-address value. For example, setting the Sub-address to **123** prevents the router from answering any calls where the sub-address called does not end in **123**.

Keep ISDN LAPB link activated when user sends a DISC or X.25 PAD session terminated

When this parameter is enabled, the following setting is enabled:

Wait x milliseconds before attempting to establish the LAPB link after B-channel becoming active

This parameter sets the length of time (in milliseconds), that the LAPB instance will wait from an ISDN B-channel becoming active before attempting to establish a LAPB connection, such as the length of time for which the LAPB instance stays passive. The default is **0**, as most ISDN networks allow CPE devices to initiate a LAPB link. If your ISDN network does not permit CPE devices to initiate the LAPB link you should set this parameter to a value that allows the network sufficient time to establish the LAPB link.

Use as x a calling party number when making ISDN calls

This is Calling Line Identification. The router will only answer calls from numbers whose trailing digits match what is entered in this field. The line the router is connected to must have CLI enabled by the telecoms provider, and the calling number cannot be withheld.

Async Mux 0710 Parameters

Certain W-WAN modules use LAPB to perform multiplexing of serial channels. If using LAPB for X.25 over ISDN or serial, you can ignore these settings. Do not change these settings unless under the instruction of Digi Technical Support.

Mux 0710 mode

If enabled, configures the LAPB instance use for multiplexing of serial channels instead of X.25.

Mux mode

Controls the multiplexing mode.

DLC #

The data link channel number to use for this virtual ASY port.

ASY port

The physical ASY port over which to multiplex.

Virtual ASY port

The virtual ASY port number that this LAPB instance will multiplex over the physical port.

3. Click **Apply**.

**Command line**

Command	Instance	Parameter	Values	Equivalent web parameter
lapb	n	liface	port, isdn (use port for sync port)	Use: Serial port Port x (in Synchronous Mode)
lapb	n	l1nb	0, 1	Use: Serial port Port x (in Synchronous Mode) 0 for Port 0 , 1 for Port 1
lapb	n	liface	port, isdn (use isdn for ISDN)	Use: ISDN
lapb	n	dtemode	DTE/DCE mode: 0=DTE 1=DCE	Mode DTE or DCE
lapb	n	N400	1-255	N400 Counter x
lapb	n	tnoact	1000-60000	RR Timer x milliseconds
lapb	n	t1time	1-60000	T1 Timer x milliseconds
lapb	n	t200	1-60000	T200 Timer x milliseconds
lapb	n	Window	1-7	X.25 Window Size
lapb	n	tinactx25	0-3000	Disconnect link if there has been no X.25 activity for x seconds
lapb	n	tinact	0-3000	Disconnect link if there has been no activity for x seconds
lapb	n	restartact	1=enabled 0=disabled	Send X.25 Restart packet on receipt of SABM frame
lapb	n	ans	1=enabled 0=disabled	Allow this unit to answer calls
lapb	n	msn	text	Only accept calls from calling number ending with
lapb	n	sub	text	Only accept calls with sub-address ending with

Command	Instance	Parameter	Values	Equivalent web parameter
lapb	n	ptime	0-60000	Wait x milliseconds before attempting to establish the LAPB link after B-channel becoming active
lapb	n	cli	text	Only answer calls from numbers whose trailing digits match
lapb	n	mux_0710	1=enabled 0=disabled	Mux 0710 mode
lapb	n	mux_mode	0=Basic 1=Error Recovery	Mux mode
lapb	n	dlc	0-63	DLC #
lapb	n	asyport	0-255	ASY port
lapb	n	virt_async	0-255	Virtual ASY port

Configure NUI mappings

When a TPAD call is taking place, the attached terminal sometimes only specifies a NUI (Network User ID) to call. If the X.25 network requires an NUA instead of an NUI to determine the destination of a call, you can use the **NUI Mappings** table to convert an NUI to an NUA. If a TPAD call specifies a call in which the NUI matches an entry the call actually placed on the network will contain the respective NUA and no NUI.

Web

1. Go to **Configuration > Network > Legacy Protocol > X.25 > NUI Mappings**.

NUI Mappings

When a TPAD call is taking place the attached terminal sometime
(You can specify up to 20 mappings)

NUI	Maps to NUA
No NUI mappings have been configured.	
<input type="text"/>	<input type="text"/> <input type="button" value="Add"/>

2. Enter the NUI mappings.
3. Click **Apply**.

Command line

Command	Instance	Parameter	Values	Equivalent web parameter
nuimap	n	nua	text	Maps to NUA
nuimap	n	nui	text	NUI

Configure NUA / NUI interface mappings

For PAD and TPAD instances, use the NUA/NUI Interface Mappings table to override the following:

- Interface
- Backup interface
- IP address
- TCP/UDP port number

Based upon data in the call request matching the following comparison fields:

- NUA called
- NUI called
- X.25 Call Data
- PID

You can use the wildcard matching characters ? and * in the comparison fields, **NUA**, **NUI**, **Call Data**, and **PID**.

Web

1. Go to **Configuration > Network > Legacy Protocol > X.25 > NUA/NUI Interface Mappings**.



Note The **Configuration > Network > Protocol Switch > NUA to Interface Mappings** section duplicates this table, as the Protocol Switch can also use it. Not all of the fields are visible in the **Protocol Switch** section, as they do not all apply to the Protocol Switch.

2. Enter NUA/NUI interface mappings:

NUA

The Network User Address.

NUI

The Network User Identifier.

Call Data

The X.25 Call Data.

PID

The Protocol Identifier.

IP address

The IP address.

IP Port

The IP port number.

Interface

The Primary interface name.

Backup Interface

The Backup interface name.

3. Click **Apply**.



Command line

Command	Instance	Parameter	Values	Equivalent web parameter
nuaip	N	nua	text	NUA
nuaip	N	nui	text	NUI
nuaip	N	cud	text	Call Data
nuaip	n	pid	text	PID
nuaip	n	IPaddr	IP address	IP Address
nuaip	n	ip_port	0-65535	IP Port
nuaip	n	swto	0 -15	Interface
nuaip	n	buswto	0 -15	Backup Interface

The interface and backup interface values are as follows:

Parameter value	Interface type
0	Default
1	LAPD
2	LAPB 0
3	LAPB 1
4	XOT
5	LAPD x (instance determined by NUA)
6	LAPB 0 PVC
7	LAPB 1 PVC

Parameter value	Interface type
8	XOT PVC
9	TCP Stream
10	UDP Stream
12	LAPB 2
13	LAPB 2 PVC
14	VXN
15	SSL

Configure X.25 call macros

You can to define up to **64** X.25 CALL macros for initiating ISDN and/or X.25 layer 3 calls. These simple English-like names are mapped to full command strings. For example, you could give the following call string the name **X25test**:

```
0800123456=789012Dtest data
```

Then you could execute this call string by entering:

```
CALL X25test
```

Web

1. Go to **Configuration > Network > Legacy Protocol > X.25 > Call Macros**.

Call Macros

X.25 Call Macros can be used to initiate ISDN and/or X.25 layer 3 calls.

You can configure up to 64 macros

Macro	Command
No X.25 Call Macros have been configured	
<input type="text"/>	<input type="text"/> <input type="button" value="Add"/>

2. To create a call macro, enter a name for the macro in the left column of the **Call Macros** table and in the right column enter the appropriate command string (excluding the ATD).

Macro

The name of the macro, this can be any text.

Command

The X.25 call command.

Add button

Adds the X.25 call macro to the X.25 configuration.

3. Click **Add**.
4. Click **Apply**.

 **Command line**

Command	Instance	Parameter	Values	Equivalent web parameter
macro	n	name	text	Macro
macro	n	cmd	text	Command

Configure IP to X.25 call strings

Web

- Go to **Configuration > Network > Legacy Protocol > X.25 > IP to X.25 Calls.**

▼ **IP to X.25 Calls**

Total sockets: 128
Sockets available: 123

(You can specify up to 50 IP to X25 Call mappings)

Port	Number of Sockets	X25 Call	PID	Confirm Mode	SSL Mode	IP Length Header
No IP Socket mappings have been configured.						
<input type="text"/>	<input type="text"/>	<input type="text"/>	<input type="text"/>	<input type="checkbox"/>	<input type="checkbox"/>	Off <input type="text"/>
<input type="button" value="Add"/>						

The **IP to X.25 Calls** page contains a table that allows you to enter a series of IP Port numbers and X.25 Call strings as shown below. These settings configure the router so that IP data can be switched over X.25. For example data that is received on a TCP connection can be answered by a PAD as if it is an X.25 call.

This table is duplicated in the [Configure Protocol Switch software](#), as the protocol switch feature also uses this table. It is included at this point in the web user interface as a convenience if you need to use it for PAD instead of the protocol switch.

- Enter the IP to X.25 calls parameters:

Total sockets
Sockets available

These display fields show the total number of sockets available and the number currently free is shown. Take care to not to allocate too many of the free sockets, unless you are confident other applications need them.

Port

Used to set up the port numbers for those IP ports that will listen for incoming connections that are to be switched over X.25 or other protocol. In the case of switching to X.25, when such a connection is made the router will make an X.25 Call to the address specified in the X.25 Call field. Once this call has been connected, data from the port will be switched over the X.25 session.

Number of Sockets

Selects how many IP sockets should simultaneously listen for data on the specified port. The number of available IP sockets will depend on the model you are using and how many are already in use (see note below).

X25 Call

The X.25 call field may contain an X.25 NUA or NUI or one of the X.25 Call Macros defined on the Configuration > Advanced applications > X25 > Macros page.

PID

The protocol ID (PID) to use when the router switches an IP connection to X.25. The PID field takes the format of four hexadecimal digits separated by commas, such as **1,0,0,0**, at the start of the **Call User Data** field in the X.25 call.

Confirm Mode

When confirm mode is set to **On**, then the incoming TCP socket is not successfully connected until the corresponding outgoing call has been connected. The incoming TCP socket triggers the corresponding outgoing call either to a local PAD instance or to whatever is configured. The effect of this mode is that the socket will fail if the outbound call fails and so may be useful in backup scenarios. In addition it will ensure no data is sent into a “black hole”. (When this setting is not enabled, data that is sent on the inbound TCP connection before the outbound connection has been successful can be lost.)

RFC 1086 Mode:

RFC 1086 specifies a mode of operation in which the IP socket answers and then with a simple protocol in the socket identifies the X.25 address and other X.25 call setup parameters to use. Then when the X.25 call parameters have been identified the X.25 call is made and if successful then data is then switched between the X.25 call and the IP socket. The protocol selects whether incoming or outgoing support is required.

IP Length Header

When IP length header is **On**, the IP length indicator field is inserted at the start of each packet. When set to **8583 Ascii 4 byte**, the IP length header conforms to the ISO 8583 format. In the example above, 3 IP sockets will listen for an incoming connection on IP Port **2004**. Once connected each socket makes an X.25 Call to **jollyroger**. The router recognizes that **jollyroger** is a pre-defined macro (as illustrated below), and translates it into an X.25 Call to address **32423** with the string **x25 data** included as data in the call. The outgoing X.25 call(s) are made over whichever interface is specified by the **Switch from XOT(TCP) to** parameter on the **Configuration > Network > Protocol Switch** page.

Add button

Adds the IP to X.25 call mapping to the X.25 configuration.

3. Click **Add** to add each call mapping.
4. Click **Apply**.



Command line

Command	Instance	Parameter	Values	Equivalent web parameter
ipx25	n	ip_port	0-65535	IP Port
ipx25	n	nb_listens	0-software-dependent max	Number of Sockets
ipx25	n	x25call	NUA, NUI or X.25 macro name	X25 Call
ipx25	n	pid	hex numbers	PID

Command	Instance	Parameter	Values	Equivalent web parameter
ipx25	n	cnf_mode	1=enabled, 0=disabled	Confirm Mode
ipx25	n	rfc1086_mode	1=enabled, 0=disabled	RFC 1086 Mode
ipx25	n	iphdr	0=Off 1=On 2=8583 Ascii 4 byte	IP length header

Configure Packet Assembler Disassembler (PADS)

Packet Assembler Disassembler (PADS) provides an interface between a character based serial connection and an X.25 synchronous packet switched network.

There are two main elements to the configuration procedure for accessing X.25 networks:

- General and service related parameters
- PAD parameters (X.3)

TransPort routers have four pre-defined standard PAD profiles numbered **50**, **51**, **90** and **91**. You can also create up to four custom PAD profiles numbered **1** to **4** for each PAD instance.

Web

1. Go to **Configuration > Network > Legacy Protocol > X.25 > PADS** .
Each X.25 PAD configuration page also includes a sub-page detailing the X.3 PAD parameters. Collectively this set of values is known as a PAD profile. Y

▼ PADs 0-9

▼ PAD 0

Use PAD over interface LAPD 0 (X.25 over ISDN D-channel)
 LAPB 0 (X.25 over ISDN B-channel)
 XOT (X.25 over TCP)
 TCP (data over TCP socket)
 UDP (data in UDP packets)
 SSL XOT
 SSL TCP

Use backup interface

X.25 Settings

Default X.25 packet size: 128 ▼

Answer incoming calls from NUA:

Only answer calls with CUG:

Use X.25 Call Macro to an ATD command

When making an outgoing call

Use NUA:

LCN: 1027

LCN direction: Down ▼

NUI/NUA selection: NUI and NUA ▼

Enable X.25 Restart Packets

Restart delay: 2000 milliseconds

Buffer data before connect: On ▼

PAD Settings

PAD prompt: PAD>

PAD mode: Normal ▼

Use PAD Profile: ▼

Strip Trailing Spaces
 Enable Leased Line Mode
 Send ENQ on Connect
 Enable STX / ETX Filtering

Delay connect message 4 x 10 milliseconds

Delay data transfer after connection by 0 x 10 milliseconds

Terminate the PAD call after 0 seconds if there has been no data transmission

Disconnect the layer 2 call if there is no layer 3 call in progress for 0 seconds

Create an event when:

the following data is on the PAD

there has been no activity on the PAD for
 0 seconds

▶ X3 Parameters

2. Set PAD parameters:

Use PAD over interface

Selects whether the PAD instance uses ISDN B-channel X.25, ISDN D-channel X.25, TCP, UDP, VXN, SSL TCP or SSL XoT as the transport protocol.

- For ISDN D-channel operation, select the **LAPD** option is selected.
- For ISDN B-channel operation or operation through a synchronous port, select **LAPB**.
- For LAPB and LAPD, you can also specify an interface number.

This parameter specifies which LAPB or LAPD instance to use for the relevant TPAD instance. Select **0** or **1** for LAPB or **0** or **1** for LAPD.

Use backup interface

A backup interface to use automatically if the call to the primary interface fails. The primary interface is tried first for every new call attempt.

3. Set X.25 settings:

Default X.25 packet size

The default X.25 packet size. This can be set to **16, 32, 64128, 256, 512** or **1024**, but the actual values permitted are normally constrained by your service provider.

Answer incoming calls from NUA

The NUA that the router responds to for incoming X.25 calls.

Only answer calls with CUG

The PAD will only answer calls with this Call User Group (CUG) specified.

Use X.25 Call Macro macroname to an ATD command

The name of an X.25 call macro to use when the router receives an **ATD** command. The router ignores the **ATD** command, replacing it with a PAD **CALL** command using the macro. The purpose of this feature is to allow non-PAD terminals to use an X.25 PAD network connection. To configure X.25 call macros, go to the **Configuration > Network > Legacy Protocols > X.25 > Call Macros** web page, or use the **macro** text command.

When making an outgoing call

Use NUA

The NUA to use as the calling NUA when the router makes an outgoing X.25 call.

LCN

The router supports up to 8 logical X.25 channels. In practice, the operational limit is determined by the particular service to which you subscribe (usually 4). Each logical channel must be assigned a valid Logical Channel Number (LCN). The LCN parameter is the value of the first LCN that will be assigned for outgoing X.25 CALLs. The default is **1027**.

For incoming calls, the router accepts the LCN specified by the caller.

LCN direction

Whether the LCN for outgoing X.25 calls is incremented or decremented from the starting value when multiple X.25 instances share one layer 2 (LAPB or LAPD), connection. The default is **Down** and LCNs are decremented, such as if the first CALL uses **1024**, the next will use **1023**, etc. Setting the parameter to **Up** causes the LCN to be incremented from the start value.

NUI/NUA selection

If both an NUI and an NUA are included in the call string, this parameter allows the router to filter one of these out of the X.25 call request. This can be extremely useful in backup

scenarios. Consider the following example; the router is configured to do online authorizations via the ISDN D channel and to fall back to B-channel (if the D-channel host did not respond for any reason). Using this parameter in conjunction with the backup equivalent, it is possible to configure the router to use the supplied NUA to connect over D-channel and the supplied NUI to connect over B channel (for backup).

On the backup interface LCN

Sets the first LCN to use for the backup interface.

On the backup interface LCN Direction

Whether the LCN for the backup X.25 interface is incremented or decremented from the starting value when multiple X.25 instances share a single layer 2 connection.

On the backup interface NUI/NUA selection

If both an NUI and an NUA are included in the call string, this parameter allows the router to filter one of these out of the X.25 call request.

Enable X.25 Restart Packets

It is normally possible to make X.25 CALLs immediately following the initial SABM-UA exchange. In some cases however, the X.25 network may require an X.25 **Restart** before it will accept X.25 CALLs. The correct mode to select depends upon the particular X.25 service to which you subscribe. The default value is **On**. This means that the router will issue X.25 **Restart** packets. To prevent the router from issuing **Restart** packets, set this parameter to **Off**.

Restart delay

When the **Restarts** parameter is **On**, the **Restart delay** value determines the length of time in milliseconds that the router will wait before issuing a **Restart** packet. The default value is **2000** giving a delay of **2** seconds.

4. Set IP settings parameters:

Remote IP address

The destination host that will answer the XOT, TCP, SSL, or UDP call.

Remote IP Address when using the backup interface

The destination host that will answer the XOT, TCP, SSL, or UDP call if a connection via the primary interface has failed and the PAD is configured to backup to a secondary interface that is using an IP based protocol.

IP Stream port

The TCP or UDP port number to use for IP (but not XoT) connections.

IP length header

When set to **On**, and in IP Stream mode, the length of a data sequence is inserted before the data. For the receive direction, it is assumed the length of the data is in the data stream. When set to **8583 Ascii 4 byte**, the IP length header conforms to the ISO 8583 format.

Set PAD parameters:

PAD prompt

Allows you to redefine the standard **PAD>** prompt. To change the prompt, enter a new string of up to **15** characters into the text box.

PAD mode

The PAD Mode parameter can be set to **Normal** or **Prompt Always On**. In Prompt Always On mode, the ASY port attached to the PAD behaves as if it were permanently connected at layer 2, such as it always displays a **PAD>** prompt. AT commands may still be entered but the normal result codes are suppressed. To disable this mode set the parameter to **Normal**.

Use PAD Profile

The PAD profile # allows you to select the PAD profile to use for this PAD instance. There are four pre-defined profiles, numbered **50**, **51**, **90**, and **91**. In addition to the pre-defined profiles, you can also create up to four user-defined profiles numbered **1**, **2**, **3**, and **4**. To assign a particular profile to the PAD select the appropriate number from the list.

Strip Trailing Spaces

If set to **On**, any spaces received at the end of a sequence of data from the network are removed before being relayed to the PAD port.

Enable Leased Line Mode

If set to **On**, causes the PAD to always attempt to be connected using the Auto macro setting as the call command.

Send ENQ on Connect

If set to **On**, the PAD sends an ENQ character on the ASY link when an outgoing call has been answered.

Enable STX / ETX Filtering

If set to **On**, the PAD ignores data that is not encapsulated between ASCII characters **STX (Ctrl+B)** and **ETX (Ctrl+C)**. To disable this feature select the **Off** option.

Delay connect message n x 10 milliseconds

Delay the **Connect** message by the number of milliseconds specified. This is useful when working with equipment previously connected to slower networks that may have difficulty processing the quicker **Connect** on modern networks.

Delay data transfer after connection by n x 10 milliseconds

Delays the data delivered from the X.25 or other type of connection to the terminal upon initial connection.

Terminate the PAD call after x seconds if there has been no data transmission

The length of time, in seconds, after which the PAD will terminate an X.25 call if there has been no data transmission.

Disconnect the layer 2 call if there is no layer 3 call in progress for x seconds

The length of time, in seconds, after which the router disconnects a layer 2 link if there are no layer 3 calls in progress. For LAPB sessions, this also terminates the ISDN call.

Create an event when the following data is on the PAD

A string, which if it appears in the received data causes a **Data Trigger** (47) event to be generated and recorded in the event log.

Create an event when there has been no activity on the PAD for x seconds

The time, in seconds, in which if there is no activity on the PAD an event in the event log is posted. You can use this parameter to trigger email exceptions.

5. Click **Apply**.

**Command line**

Command	Instance	Parameter	Values	Equivalent web parameter
pad	n	l2iface	lapb, lapd, TCP, SSL	Use PAD over interface
pad	n	l2nb	0-255 (instance of LAPB or LAPD)	Use PAD over interface
pad	n	ip_stream	0=off (for XoT), 1=TCP, 2=UDP	Use PAD over interface
pad	n	defpak	16,32,64,128,256,512 or 1024	Default X.25 packet size
pad	n	ansnua	text (valid NUA)	Answer incoming calls from NUA
pad	n	anscug	text (valid CUG)	Only answer calls with CUG
pad	n	amacro	text	Use X.25 Call Macro macroname to an ATD command
pad	n	cingnua	text (valid NUA)	Use NUA
pad	n	lcn	1-4095	LCN
pad	n	lcnap	1=up, 0=down	LCN Direction
pad	n	nuaimode	0=NUI and NUA, 1=NUA only, 2=NUI only	NUI/NUA selection
pad	n	dorest	1=enabled, 0=disabled	Enable X.25 Restart Packets
pad	n	restdel	0 -60000 (ms)	Restart delay
pad	n	IPaddr	text	Remote IP address

Command	Instance	Parameter	Values	Equivalent web parameter
pad	n	buiaddr	text	Remote IP Address when using the backup interface
pad	n	ip_port	0-65535	IP Stream port
pad	n	iphdr	0=Off 1=On 2=8583 Ascii 4 byte	IP length header
pad	n	prompt	text	PAD prompt
pad	n	padmode	0=Normal 1=Prompt Always On	PAD mode
pad	n	profile	1-4, 50, 51,90,91	Use PAD Profile
pad	n	strip_tspaces	1=enabled 0=disabled	Strip Trailing Spaces
pad	n	llmode	1=enabled 0=disabled	Enable Leased Line Mode
pad	n	enqcon	1=enabled 0=disabled	Send ENQ on Connect
pad	n	stxmode	1=enabled 0=disabled	Enable STX / ETX Filtering
pad	n	delconmsg	0-10	Delay connect message n x 10 milliseconds
pad	n	data_del	0-2147483647	Delay data transfer after connection by n x 10 milliseconds
pad	n	inacttim	0-1000	Terminate the PAD call after x seconds if there has been no data transmission
pad	n	nocalltim	0-60000	Disconnect the layer 2 call if there is no layer 3 call in progress for x seconds
pad	n	trig_str	text	Create an event when the following data is on the PAD
pad	n	inactevent	0-2147483647	Create an event when there has been no activity on the PAD for x seconds

Stopping and starting PADs

To stop and start PAD instances, use the following CLI commands:

- **stoppads:** Stops all PAD instances from accepting and performing any PAD commands.
- **gopads:** Resumes processing of PAD commands.

The **stoppads** and **gopads** commands can have the PAD number specified in the syntax to stop and start individual PAD instances.

For example:

- To stop PAD 1 from processing PAD commands:

```
stoppads 1
```

- To re-enable PAD 1:

```
gopads 1
```

X3 parameters

Each PAD configuration page has an attached sub-page that allows you to edit the X.3 PAD parameters. These pages allow you to load one of the standard profiles or edit the individual parameters to suit your application requirements and save the resulting customized user profile to non-volatile memory.

Loading and saving PAD profiles

To create your own PAD profiles, edit the appropriate parameters and then select user profile 1, 2, 3 or 4 as required from the list and click the **Save Profile** button. Each PAD profile page includes two list boxes for loading and saving PAD profiles. To load a particular profile, select the profile from the list and click the **Load Profile** button. The parameter table is updated with the values from the selected profile.

▼ X3 Parameters

Parameter	Name	Value
1	PAD recall character	1
2	Echo	0
3	Data forwarding characters	0
4	Idle timer delay	5
5	Ancillary device control	0
6	Suppression of PAD service signals	5
7	Action on break (from DTE)	0
8	Discard output	0
9	Padding after CR	0
10	Line folding	0
11	Port speed	15
12	Flow control of PAD (by DTE)	0
13	LF insertion (after CR)	0
14	LF padding	0
15	Editing	0
16	Character delete character	8
17	Line delete character	24
18	Line redisplay character	18
19	Editing PAD service signals	2
20	Echo mask	64
21	Parity treatment	0
22	Page wait	0

Save Profile 1 ▼
 Load Profile 1 ▼

Apply

1 PAD recall character

Determines whether PAD recall is enabled. When this facility is enabled, typing the PAD recall character temporarily interrupts the call and returns you to the PAD> prompt where you may enter normal PAD commands as required. To resume the interrupted call, use the **CALL** command without a parameter. The default PAD recall character is **[Ctrl-P]**. This may be changed to any ASCII value in the range 32-125 or disabled by setting it to **0**. When a call is in progress and you need to actually transmit the character that is currently defined as the PAD recall character, simply enter it twice. The first instance returns you to the **PAD>** prompt; the second resumes the call and transmits the character to the remote system.

Option	Description
0	Disabled

Option	Description
1	PAD recall character is CTRL-P (ASCII 16, DEL)
32-126	PAD recall character is user defined as specified

2 Echo

Enables or disables local echo of data transmitted during a call. When echo is enabled, you can use X.3 parameter **20** to inhibit echoing certain characters.

Option	Description
0	Echo off
1	Echo on

3 Data forwarding characters

Defines which characters cause data to be assembled into a packet and forwarded to the network.

Option	Description
0	No data forwarding character
1	Alphanumeric characters (A-Z, a-z, 0-9)
2	CR
4	ESC, BEL, ENQ, ACK
8	DEL, CAN, DC2
16	EXT, EOT
32	HT, LF, VT, FF
64	Characters of decimal value less than 32

Combinations of the above sets of characters are possible by adding the respective values together. For example, to define CR, EXT and EOT as data forwarding characters, set this parameter to **18 (2 + 16)**. If no forwarding characters are defined the Idle timer delay (parameter **4**) should be set to a suitable value, typically **0.2 seconds**.

4 Idle timer delay

Defines a time-out period after which data received from the DTE is assembled into a packet and forwarded to the network. If the forwarding time-out is disabled, one or more characters should be selected as data forwarding characters using parameter **3**.

Option	Description
0	No data forwarding time-out
1	Data forwarding time-out in 20ths of a second.

5 Ancillary device control

Determines method of flow control the PAD uses to temporarily halt and restart the flow of data from the DTE during a call.

Option	Description
0	No flow control
1	XON/XOFF flow control
3	RTS/CTS flow control (not a standard X.3 parameter)

6 Suppression of PAD service signals

Determines whether or not the **PAD>** prompt and/or **Service/Command** signals are issued to the DTE.

Option	Description
0	PAD prompt and signals disabled
1	PAD prompt disabled, signals enabled
4	PAD prompt enabled, signals disabled
5	PAD prompt enabled, signals disabled

7 Action on break (from DTE)

Determines the action taken by the PAD on receipt of a break signal from the DTE.

Option	Description
0	No action
1	Send an X.25 interrupt packet
2	Send an X.25 reset packet to the remote system
4	Send an X.29 indication of break
8	Escape to PAD command state
16	Set PAD parameter 8 to 1 to discard output

Multiple actions on receipt of break are possible, by setting this parameter to the sum of the appropriate values for each action required. For example, when parameter **7** is set to **21** (**16 + 4 + 1**), an X.25 interrupt packet is sent followed by an X.29 indication of break, and then parameter **8** is set to **1**. Do not set this parameter to **16**; doing so would mean the remote system would receive no indication that a break had been issued and output to the DTE would therefore remain permanently discarded. If you need to use the discard output option, use it with the X.29 break option. so that on receipt of the X.29 break, the remote system can re-enable output to your DTE using parameter **8**.

8 Discard output

Determines whether data received during a call is passed to the DTE or discarded. The remote system can directly set this value only; you can use this setting in a variety of circumstances when the remote

DTE cannot handle a continuous flow of data at high speed.

Option	Description
0	Normal data delivery to DTE
1	Output to DTE discarded

9 Padding after CR

Slower terminal devices, such as printers, may require a delay after each Carriage Return before they can continue to process data. This parameter controls the number of pad characters (**NUL-ASCII 0**) that are sent after each CR to create such a delay.

Option	Description
0	No padding characters after CR
1-255	Number of padding characters (NUL) sent after CR

10 Line folding

Controls the automatic generation of a **[CR],[LF]** sequence after a certain line width has been reached.

Option	Description
0	No line folding
1-255	Width of line before the PAD generates [CR],[LF]

11 Port speed

This is a read only parameter, set automatically by the PAD and accessed by the remote system.

Option	Description
15	19,200 bps
14	9,600 bps
12	2,400 bps
3	2,400 bps

12 Flow control of PAD (by DTE)

Determines the flow control setting of the PAD by the DTE in the on-line data state.

Option	Description
0	No flow control
1	XON/XOFF flow control
3	RTS/CTS flow control (not a standard X.3 parameter)

13 LF insertion (after CR)

Controls the automatic generation of a Line Feed by the PAD.

Option	Description
0	No line feed insertion
1	Line Feeds inserted in data passed TO the DTE
2	Line Feeds inserted in data received FROM the DTE
4	Line Feeds inserted after CRs echoed to DTE

The line feed values can be added together to select Line Feed insertion to any desired combination.

14 LF padding

Some terminal devices, such as printers, require a delay after each Line Feed before they can continue to process data. This parameter controls the number of padding characters (**NUL-ASCII 0**) that are sent after each **[LF]** to create such a delay.

Option	Description
0	No line feed padding.
1-255	Number of NUL characters inserted after LF

15 Editing

Enables (**1**) or disables (**0**) local editing of data input fields by the PAD before data is sent. The three basic editing functions provided are character delete, line delete and line re-display.

The editing characters are defined by parameters **16**, **17**, and **18**. In addition, parameter **19** determines which messages are issued to the DTE during editing. When editing is enabled, the idle timer delay (parameter **4**) is disabled. You must use parameter **3** to select the desired data forwarding condition.

16 Delete character

The edit mode delete character (ASCII 0-127). The default is backspace (**ASCII 08**).

17 Line delete character

The edit mode line buffer delete character (**ASCII 0-127**). The default is **CTRL-X (ASCII 24)**.

18 Line redisplay character

The character that re-displays the current input field when in editing mode (**ASCII 0-127**). The default is **CTRL-R (ASCII 18)**.

19 Editing PAD service signals

The type of service signal sent to the DTE when editing input fields.

Option	Description
0	No editing PAD service signals.
1	PAD editing service signals for printers.
2	PAD editing service signals for terminals.

20 Echo mask

Defines characters that are not echoed when echo mode has been enabled using parameter 2.

Option	Description
0	No echo mask (all characters are echoed)
1	CR
2	LF
4	VT, HT or FF
8	BEL, BS
16	ESC,ENQ
32	ACK,NAK,STX,SOH,EOT,ETB,ETX
64	No echo of characters set by parameters 16, 17 & 18
128	No echo of characters set by parameters 16, 17 & 18

Combinations of the above sets of characters are possible by adding the respective values together.

21 Parity treatment

Sets use of parity generation/checking.

Option	Description
0	No parity generation or checking
1	Parity checking on
2	Parity generation on
3	Parity checking and generation on

22 Page wait

Determines how many line feeds are sent to the terminal before output is halted on a page wait condition. In other words, it defines the page length for paged mode output. A page wait condition is cleared when the PAD receives a character from the terminal.

Option	Description
0	Page wait feature disabled
1	Number of line feeds sent before halting output

**Command line**

To edit the X.3 PAD parameters from the command line, use the **set** command, described in [X.25 packet switching](#).

Configure an X.25 Permanent Virtual Circuit (PVC)

A Permanent Virtual Circuit (PVC) provides the X.25 equivalent of a leased line service. With a PVC there is no call setup or disconnect process; you can just start sending and receiving X.25 data on a specified LCN. For each X.25 service connection you may setup up multiple PVCs each of which uses a different LCN (or a mixture of PVCs and SVCs). Digi routers support up to four PVCs numbered **0-3**.

Web

- Go to **.Configuration > Network > Legacy Protocol > X.25 > X.25 PVCs > X.25 PVC n**.

- Configure X.25 PVC parameters:

Enable this PVC

Enables or disables the PVC.

LCN

The LCN value use for this PVC. For an XOT PVC, this parameter defines the **Responder LCN** field in the PVC setup packet, though the XOT PVC connection always uses an LCN of **1**. For an XOT PVC, this field should contain the remote connection’s LCN.

PVC Mode

The lower layer interface use for the PVC. This setting can be set to **LAPB**, **LAPD** or **TCP**, for XOT mode.

Connect this PVC to PAD x

What type of upper layer interface is connected to this PVC and can be set to **PAD** for an X.25 PAD, **TPAD** for a TPAD instance, or **XSW** for X.25 switching. If set to **XSW** for the X.25 switch, the

X.25 switch must also be configured regarding the interfaces to switch this PVC to/from. For example, if this is an incoming XOT PVC we are configuring, the Switch from XOT PVC parameter must be set to the desired destination interface.

Use packet size

The packet size for the PVC. Select the appropriate value from the drop down list.

Use window size

The layer 3 window size for the PVC. Select the appropriate value from the drop down list.

Remote IP address

The IP address for outgoing XOT calls.

Use the source IP address from interface x,y

Which Ethernet or PPP interface to use for the source IP address.

Initiator interface

The name of the interface from which the PVC was initiated, such as **Serial 1**. The initiator and responder strings identify the circuit when PVCs are being set up. They must match the names in the remote router that terminates the XOT PVC connection. If the unit terminating the PVC XOT connection is not another Digi router, you must refer to the documentation or the configuration files of the other unit to determine the names of the interfaces.

Responder interface

The name of the interface to which a PVC initiator is connected, such as **Serial 2**.

3. Click **Apply**.



Command line

Command	Instance	Parameter	Values	Equivalent web parameter
pvc	n	l2iface	Blank or lapb, lapd, tcp	Enable this PVC
pvc	n	lcn	0-4096	LCN
pvc	n	uliface	pad, tpad, xsw	Connect this PVC to PAD x
pvc	n	psize	0=default 4=16 5=32 6=64 7=128 8=256 9=512 10=1024	Use packet size
pvc	n	window	1-7	Use window size
pvc	n	ipaddr	IP address	Remote IP address

Command	Instance	Parameter	Values	Equivalent web parameter
pvc	n	srcipent	auto, eth, ppp	Use the source IP address from interface x,y
pvc	n	srcipadd	0-255	Use the source IP address from interface x,y
pvc	n	iniface	text	Initiator interface
pvc	n	respiface	text	Responder interface

X.25 packet switching

X.25 is a data communications protocol employed throughout the world for wide area networking across Packet Switched Data Networks (PSDNs). The X.25 standard defines the way in which terminal equipment establishes, maintains and clears Switched Virtual Circuits (SVCs), across X.25 networks to other devices operating in packet mode on these networks.

The protocols involved in X.25 operate at the lower three layers of the ISO model:

- At the lowest level the Physical layer defines the electrical and physical interfaces between the DTE and DCE.
- Layer 2 is the Data Link Layer that defines the unit of data transfer as a “frame” and includes the error control and flow control mechanisms.
- Layer 3 is the Network layer. This defines the data and control packet structure and the procedures for accessing services that are available on PSDNs.

Another standard, X.31, defines the procedures for accessing X.25 networks via the ISDN B and D-channels.

Digi ISDN products include support for allowing connected terminals to access X.25 over ISDN B channels, the ISDN D-channel or over TCP. They can also be configured so if there is a network failure, the router automatically switches to using an alternative service. The Packet Assembler/Disassembler (PAD) interface conforms to the X.3, X.28, and X.29 standards.

Up to 6 PAD instances, from an available pool of 8, can be created and dynamically assigned to the asynchronous serial ports or the REM pseudo-port.

Each application that uses the router to access an X.25 network has its own particular configuration requirements. For example, you may need to program your Network User Address (NUA) and specify which Logical Channel Numbers (LCNs) to use on your X.25 service. This information is available from your X.25 service provider. You also need to decide whether your application uses B- or D-channel X.25.

Once you have this information, use the PAD configuration pages to set up the appropriate parameters.

B-channel X.25

The router can transfer data to/from X.25 networks over either of the ISDN B-channels.

Once the router has been configured appropriately, the ISDN call to the X.25 network can be made using an **ATD** command or by executing a pre-defined macro. The format of the **ATD** command allows you to combine the ISDN call and the subsequent X.25 call in a single command. Alternatively, the X.25 call may be made separately from the **PAD>** prompt once the ISDN connection to the X.25 network has been established.

D-channel X.25

The router can transfer data to/from X.25 networks over the ISDN D-channel if your ISDN service provider supports this facility. The speed at which data can be transferred varies depending on the service provider, but is generally **9600** bits per second or lower.

X.28 commands

Once an X.25 session layer has been established the router switches to **PAD** mode. In this mode, operation of the PAD is controlled using the standard X.28 PAD commands listed in the following table:

Command	Description
CALL	Make an X.25 call.
CLR	Clear an X.25 call.
ICLR	Invitation to CLR.
INPAR?	List X.3 parameters of specified PAD instance.
INPROF	Load or save specified PAD profile.
INSET	Set X.3 parameters of specified PAD instance.
INT	Send Interrupt packet.
LOG	Log off and disconnect.
PAR?	List local X.3 parameters.
PROF	Load or save PAD profile.
RESET	Send reset packet.
RPAR?	List remote X.3 parameters.
RSET	Set remote X.3 parameters.
SET	Set local X.3 parameters.
STAT	Display channel status.

CALL command: Make an X.25 call

The full structure of a **CALL** command is:

```
CALL [<facilities->]<address>[D<user data>]
```

where:

- **<facilities->** is an optional list of codes indicating the facilities to be requested in the call (separated by commas, terminated with a dash)
- **<address>** is the destination network address.
- **<user data>** is any optional user data to be included with the call.

The facility codes supported are:

- **F**: Fast select-no restriction
- **Q**: Fast select-restricted response
- **Gnn**: Closed User Group
- **Gnnnn**: Extended Closed User Group
- **R**: Reverse charging
- **N<NUI>**: Network User Identity code (NUI)

Example

The following command places a call to address **56512120** using reverse charging and specifying **Closed User Group 12**. The string **MYNUI** is your Network User Identity. The string **Hello** appears in

the user data field of the call packet.

```
CALL R,G12,NMYNUI-56512120DHello
```

Note The particular facilities available vary among X.25 service providers.

If a **CALL** command is issued without the address parameter, it is assumed you want to go back on-line to a previously established call, using the PAD recall facility to temporarily return to the **PAD>** prompt.

Fast select (ISDN B-channel only)

When the standard Fast select facility is requested using the **F** facility code, the call packet generated by the **CALL** command is extended to allow the inclusion of up to **124** bytes of user data. For example: **CALL F-1234567890D**This DATA sent with call packet

causes an X.25 **CALL** packet to be sent using the Fast select facility including the message **This DATA sent with call packet**. The Carriage Return for entering the command is not transmitted. If the Fast select facility code is not included, only the first **12** characters are sent.

When a Fast select **CALL** has been made, the PAD accepts an extended format response from the called address. This response, consisting of up to **124** bytes of user data, can be appended to the returning call accepted or call clear packet. When one of these packets is received, the user data is extracted and passed from the PAD to the terminal immediately prior to the **CLR DTE . . .** message in the case of a call clear packet or **CON COM** message in case of a call accepted packet.

When a restricted response Fast select call has been made using the **Q** facility code, the call packet indicates that a full connection is not required, so that any response to the user data in the **CALL** packet should be returned in a call clear packet.

When the PAD receives an incoming call specifying Fast select, the call is indicated to the terminal in the normal way. For example:

```
IC 1234567890 FAC: Q,W:2 COM
```

indicates that an incoming call had been received requesting Restricted response fast select and a window size of **2**. The user (or system) then has **15** seconds in which to pass up to **124** bytes of data to the PAD to be included in the clear indication packet that is sent in response to the call.

The PAD does not differentiate between standard and restricted response Fast select on incoming calls and, consequently, will always respond with a clear indication.

Network User Identity (NUI)

The **N** facility code allows you to include your Network User Identity in the call packet. For security reasons, the PAD echoes each character as an asterisk (*) during the entry of an NUI. Some X.25 services use the NUI field to pass both a username and password for validation. For example, if your username is **MACDONALD** and your password is **ASDF**, a typical **CALL** command would have the format:

```
CALL NMACDONA;ASDF-56512120
```

where the **;** character separates the username from the password.

Closed User Group (CUG)

Most X.25 networks support Closed User Groups. Closed User Groups restrict subscribers to only making calls or receiving calls from other members of the same CUG. The CUG number effectively provides a form of sub-addressing working with the NUA to identify the destination address for a call.

When the G facility code is specified in a CALL packet, it must be followed by the CUG number. This can be a 2- or 4-digit number. If you are a member of a closed user group, the network may restrict you to only making calls to or receiving calls from other members of the same group.

Reverse charging

Reverse charging, specified using the R facility code, allows outgoing calls to be charged to the account of destination address. Whether or not a call is accepted on a reverse charging basis is determined by the service provider and by the type of account held by the called user.

Calling user data

The calling user data field for a normal call can contain up to 12 bytes of user data. If the first character is an exclamation mark (!), the PAD omits the 4-byte protocol identifier, and allows the full **16** bytes as user data. The same is true for a fast select call, except the maximum amount of user data is increased from **124** to **128** bytes. When entering user data, you can use the tilde character (~) to toggle between ASCII and binary mode. In ASCII mode, data is accepted as typed, but in binary mode, you must enter each byte as the required decimal ASCII code separated by commas. For example, to enter the data **Line1** followed by **[CR][LF]** and **Line2**, enter:

```
DLine1~13,10~Line2
```

CLR command: Abort a CALL command

To abort an X.25 CALL, use the X.28 CLR command, do one of the following:

- Press **[Enter]**.
- Drop **DTR** from the terminal while the call is in progress. Dropping **DTR** will also terminate an established call.

If a call is terminated by the network or by the remote host, the router returns a diagnostic message before the **NO CARRIER** result code. Messages can be numeric or verbose, depending on the setting of the **ATV** command.

Verbose messages and their numeric codes

The following table lists the verbose messages and equivalent numeric codes:

Note The router may abbreviate some verbose messages.

Code	Verbose message
1	Unallocated (unassigned) number
2	No route to specified transit network
3	No route to destination
4	Channel unacceptable
6	Channel unacceptable
7	Call awarded and being delivered in an established channel
16	Normal call clearing

Code	Verbose message
17	User busy
18	No user responding
19	No answer from user (user alerted)
21	Call rejected
22	Number changed
26	Non-selected user clearing
27	Destination out of order
28	Invalid number format
29	Facility rejected
30	Response to STATUS ENQUIRY
31	Normal, unspecified
34	No circuit/channel available
38	Network out of order
41	Temporary failure
42	Switching equipment congestion
43	Access information discarded
44	Requested circuit/channel not available
47	Resources unavailable, unspecified
49	Quality of service unavailable
50	Requested facility not subscribed
57	Bearer capability not authorized
58	Bearer capability not presently available
63	Service or option not available, unspecified
65	Bearer capability not implemented
66	Channel type not implemented
69	Requested facility not implemented
70	Only restricted digital information bearer
79	Service or option not implemented, unspecified
81	Invalid call reference value
82	Identified channel does not exist

Code	Verbose message
83	A suspended call exists, but this call identity does not
84	Call identity in use
85	No call suspended
86	Call having the requested call identity has been cleared
88	Incompatible destination
90	Destination address missing or incomplete
91	Invalid transit network selection
95	Invalid message, unspecified
96	Mandatory information element is missing
97	Message type non-existent or not implemented
98	Message not compatible with call state or message type nonexistent or not implemented
99	Information element non-existent or not implemented
100	Invalid information element contents
101	Message not compatible with call state
102	Recovery on timer expired
111	Protocol error, unspecified
127	Interworking, unspecified
128	General level 2 call control failure (probable network failure)

CLR command: Clear an X.25 Call

The **CLR** command clears the current call and release the associated virtual channel for further calls. On completion of call clear, the **PAD>** prompt is re-displayed. Several other situations can clear a call. If one of these situations occurs, a message is issued to the PAD in the following format:

```
CLR <Reason> C:<n> - <text>
```

where:

- **<Reason>** is a 2/3 character clear down code
- **<n>** is the numeric equivalent of the clear down code
- **<text>** is a description of the reason for clear down

The clear down reason codes supported by the router are listed in the following table:

Reason Code	Numeric Code	Text
DTE	0	by remote device

Reason Code	Numeric Code	Text
OOC	1	number busy
INV	3	invalid facility requested
NC	5	temporary network problem
DER	9	number out of order
NA	11	access to this number is barred
NP	13	number not assigned
RPE	17	remote procedure error
ERR	19	local procedure error
ROO	21	cannot be routed as requested
RNA	25	reverse charging not allowed
ID	33	incompatible destination
FNA	41	fast select not allowed
SA	57	ship cannot be contacted

If an unknown reason code is received, the text field is blank.

ICLR command: Invitation To CLR

The **ICLR** command invites the remote X.25 service to CLR the current X.25 session.

INT command: Send interrupt packet

INT causes PAD to transmit an interrupt packet. These packets flow outside normal buffering/flow control constraints interrupt the current activity.

LOG command: Log off and disconnect

LOG terminates an X.25 session. It causes the PAD to clear any active X.25 calls, disconnect, and return to AT command mode.

PAR? command: List local X.3 parameters

PAR? lists the local X.3 parameters for the current session.

PROF command: Load or save a PAD profile

The **PROF** command stores or retrieves a pre-defined set of X.3 PAD parameters, called a PAD profile. The information is stored in system file called **X3PROF**. There are **4** pre-defined profiles, numbered **50**, **51**, **90**, and **91**. Additionally, you can create **4** user PAD profiles, numbered **1** to **4**. Profile **50** is automatically loaded when a PAD is first activated. To load one of the other pre-defined profiles, use the **PROF** command, followed by the required profile number. For example:

```
PROF 90
```

To create a user PAD profile, use the **SET** command to configure the various PAD parameters to suit your application, then use the **PROF** command in the format:

```
PROF &nn
```

where **nn** is the number of the User PAD profile to store, such as **03**. Alternatively, you can use the web interface to edit the parameters directly (**Configuration > Network > Legacy Protocols > X.25 > PADs n-n > PAD n > PAD Settings**).

The pre-defined profiles (**50, 51, 90, 91**), cannot be overwritten and are permanently configured as shown in the following table:

Parameter	Profile			
	50	51	90	91
1	1	0	1	0
2	0	0	1	0
3	0	0	126	0
4	5	5	0	20
5	0	3	1	0
6	5	5	1	0
7	0	8	2	2
8	0	0	0	0
9	0	0	0	0
10	0	0	0	0
11	15	15	15	15
12	0	3	1	0
13	0	0	0	0
14	0	0	0	0
15	0	0	0	0
16	8	8	127	127
17	24	24	24	24
18	18	18	18	18
19	2	2	1	1
20	64	64	0	0
21	0	0	0	0
22	0	0	0	0

Stored X.25 PAD profiles are held in non-volatile memory, and are not lost when the router is switched off. When in the following format, the **PROF** command loads the stored profile specified by **nn**:

```
prof nn
```

RESET command: Send reset packet

RESET issues a reset for the current call to the network. It does not clear the call, but it does return the network level interface to a known state by re-initializing all Level 3 network control variables. All data in transit is lost.

RPAR? command: Read remote X.3 parameters

RPAR? lists the current X.3 parameter settings for the remote system.

RSET command: Set remote X.3 parameters

RSET sets one or more X.3 parameters for the remote system. It is entered in the format:

```
RSET par #:value[,par #:value[,par #:value ...]]
```

SET command: Set local X.3 parameters

SET sets one or more of the local X.3 parameters for the duration of the current session. The format of the command is:

```
SET par #:value[,par #:value[,par #:value ...]]
```

STAT Display Channel Status

STAT displays the current status for each logical channel indicating whether it is free or engaged. For example:

```
stat
PAD STATE
1  ENGAGED
2  FREE
3  FREE
4  FREE
```

Configure a MODBUS gateway

Digi TransPort routers support conversion from MODBUS serial to MODBUS TCP.

Requirements for MODBUS support in TransPort devices

When converting from MODBUS serial to MODBUS TCP over a WAN link, it is necessary to have intelligence in the router to minimize the effect of the higher latency.

Digi TransPort supports being a MODBUS server only. Clients, such as remote PCs, can send overlapping requests. The router will create a queue of info requests and deal with them appropriately, sending them out over the serial port and relaying the responses back. Overlapping polls from multiple clients are supported.

Configure the MODBUS gateway

Web

- Go to **Configuration > Network > Legacy Protocols > MODBUS Gateway > Modbus Gateway n.**

▼ MODBUS Gateway

▼ MODBUS 0

Enable MODBUS Gateway

Async Port:

Async Mode: ▼

Duplex Mode: ▼

Operation Mode: ▼

Idle Gap: milliseconds

Fix slave address:

Adjust slave address:

Response time(msecs):

IP Port	Number of Sockets	IP Mode	Modbus-in-IP(i.e. no Modbus TCP/IP Header) Mode
502	<input type="text" value="0"/>	TCP ▼	<input type="checkbox"/>
502	<input type="text" value="0"/>	TCP ▼	<input type="checkbox"/>

Total sockets: 128
 Currently available sockets: 123

- Configure MODBUS gateway parameters:

Enable MODBUS Gateway

Enables or disables MODBUS gateway instance.

Async Port

The local serial port number (asynchronous port) for the MODBUS serial interface.

Async Mode

The serial driver for RS232 or RS485 on supported hardware.

Duplex Mode

The duplex mode, which can be **half** or **full**. Use **full** for 4-wire installations; otherwise **half** is required.

Operation Mode

The operation mode to master or slave.

Idle Gap

When receiving an modbus response from a station when this idle gap (pause with no reception of characters) is detected the message (currently received from the station) is at that staged forwarded on as the complete response.

Fix slave address

The address of the slave is fixed at this value. An address conversion will occur if a message that does not contain this address is received from the TCP master. If you do not use this setting, the TCP master must use the correct slave address.

Adjust slave address

The address of the slave is adjusted by this value. If left at **0**, the slave address is not adjusted at all.

Response time

This parameter is used in master mode. It specifies the amount of time, in milliseconds, that the router waits for a for a response after polling a station. Default is **700** milliseconds. This timer stops as soon the router receives the first few serial characters from the slave, since a response is coming and is either end good or a bad CRC.

IP Port

The UDP or TCP port on which to listen for protocol messages.

IP Mode

Select the IP mode using this drop down list. The default mode is **TCP**.

3. Click **Apply**.

 **Command line**

Command	Instance	Parameter	Values	Equivalent web parameter
modbus	n	enabled	1=enabled 0=disabled	Enable MODBUS Gateway
modbus	n	asy_add	0-255	Async Port
modbus	n	op_mode	Master/Slave	Operation mode
modbus	n	async_mode	RS322 or RS422	Async Mode
modbus	n	duplex	0=full 1=half	Duplex Mode
modbus	n	idle_gap	0-2147483647	Idle Gap
modbus	n	fix_slave_address	0-255	Fix slave address
modbus	n	adj_slave_address	0-255	Adjust slave address
modbus	n	ipport0	0-65535	IP Port (row 1)
modbus	n	nbsocks0	0 -“currently available”	Number of sockets (row 1)
modbus	n	ipmode0	0=TCP, 1=UDP	IP Mode (row 1)
modbus	n	rawmode0	1=enabled 0=disabled	Raw Mode (row 1)
modbus	n	lpport1	0-65535	IP Port (row 2)
modbus	n	nbsocks1	0 -“currently available”	Number of sockets (row 2)
modbus	n	ipmode1	0=TCP, 1=UDP	IP Mode (row 2)
modbus	n	rawmode1	1=enabled 0=disabled	Raw Mode (row 2)
modbus	n	bcasts_on	off, on	Broadcast support.
modbus	n	response_to		Response time

Configure MODBUS slaves

 **Web**

Go to **Configuration > Network > Legacy Protocols > MODBUS Gateway > Modbus Slaves**.

The **MODBUS Slaves** page defines access for the following MODBUS slaves when operating as act-as-slave. You can define up to **32** MODBUS slaves.

MODBUS Slaves

Define access for the following modbus slaves when operating as "act-as-slave" (you may specify up to 32 slave definitions).

Slave addresses/unit ids	Remote Host	IP Port	IP Mode
No Slaves have been added			
<input type="text"/>	<input type="text"/>	502	TCP ▼
<input type="button" value="Add"/>			

Slave addresses/unit ids

The address of the slave unit.

Remote Host

The IP address of the remote host, such as the slave unit.

IP Port

The IP port number. The default port is **502**.

IP Mode

Select the IP mode using this drop down list. The default mode is **TCP**.

Add

Adds the slave to the MODBUS configuration.

Configure Protocol Switch software

The Protocol Switch software is available on some of the Digi TransPort models.

The Protocol Switch provides X.25 call switching between the various protocols and interfaces that may be available including:

Interface / Protocol	Handling through Protocol Switch
Off/None	Data is not switched from or backed-up to this protocol.
LAPD	Data is switched from or backed-up to LAPD using the X.25 service.
LAPD X	As above, but the actual LAPD instance to use is determined by the NUA.
LAPB 0	Data is switched from or backed-up to LAPB 0.
LAPB 1	Data is switched from or backed-up to LAPB 1.
LAPB 2	Data is switched from or backed-up to LAPB 2.
LAPB 0 PVC	Data is switched from or backed-up to an X.25 PVC on LAPB 0.
LAPB 1 PVC	Data is switched from or backed-up to an X.25 PVC on LAPB 1.
LAPB 2 PVC	Data is switched from or backed-up to an X.25 PVC on LAPB 2.
XoT	Data is switched from or backed-up to an XOT (X.25 over TCP/IP) connection.
XoT PVC	Data is switched from or backed-up to an XOT PVC connection.
TCP stream	Data is switched from / backed-up to a TCP socket. The socket's IP address will be determined from the IP stream port setting.
UDP stream	Similar to the TCP stream setting, but instead of switching onto a TCP socket, data is switched onto a UDP socket. In the case of switching from X.25, the effect is that a UDP frame will be sent for each packet of X.25 data being switched.
VXN	Data is switched or backed-up to Datawire's VXN protocol.
SSL	Data is switched or backed-up to SSL.
DialServ	Data is switched or backed-up to an analog modem via the built-in DialServ daughter card.

When this optional feature is included, the device can be configured to pass X.25 calls or data received in a TCP connection to another protocol or interface.

In addition, it is possible to specify a backup protocol or interface so if an outgoing call on one interface fails, the backup interface is automatically tried. You can use LAPB to switch to either ISDN or X.25 over serial, depending on the configuration of the LAPB instance chosen.

Protocol Switch software logic

This flowchart outlines the logic in the switching software. The notes after the flowchart provide a more in-depth explanation of the actions taken in each of the numbered boxes.

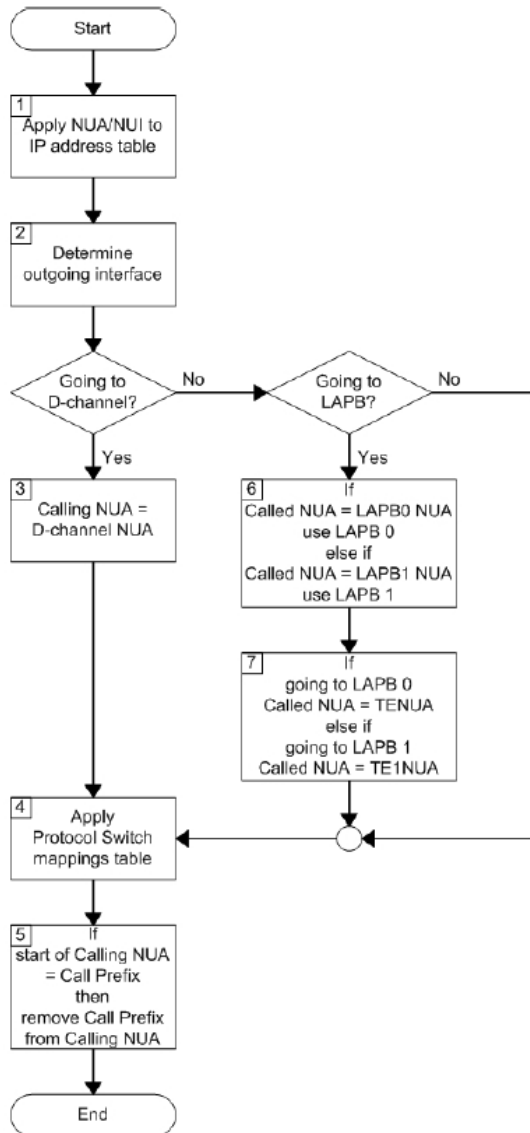

- The router first looks up the Called NUA/NUI in the **Configuration > Network > Protocol Switch > NUA to Interface Mappings** mapping table to determine the IP address to use in the event that the call ends up being switched to a TCP or XOT interface. If a match is found on the Called NUA/NUI the router assigns the matching IP address from the table to the call. If IP address mapping table does not contain an entry for the Called NUA/NUI and the call is eventually switched to a TCP or XOT channel, the router uses the default IP address (**IP Stream** or **XOT Remote IP Address**).

- The router then determines from the source interface of the incoming call which interface type it should be switched to, from the **Switch from** parameters on the **Protocol Switch** page.
 - For example, if the call arrived via a LAPB 0 interface and the Switch from LAPB 0 to parameter was set to LAPD, then the outgoing interface would LAPD.
 - If the outgoing interface is LAPD the router changes the Calling NUA field of the incoming call to the D-Channel NUA value (as defined on the **Protocol Switch** page). If the outgoing interface is NOT LAPD processing proceeds as at step 6.
- The router then searches the **Configuration > Network > Protocol Switch > NUA Mappings** table to see if there are any matches for the **Called** or **Calling NUA** values on the specified interface. When the **Interface Description** is **Off/None** data is not switched from or backed-up from this protocol is a match, the **NUA In** value is substituted by the **NUA Out** value, as the mapping is applied individually to both the **Calling NUA** and **Called NUA** for the packet.
- The router checks the leading characters of the **Calling NUA** to see if there is a match with the **Call Prefix** parameter. If there is a match, the prefix digits are removed before the outgoing X.25 call is made. Otherwise, the call is made anyway, and the switching process is complete for this call.
- If after step 3, the router has determined that the outgoing interface is not LAPD, it checks if the outgoing interface is LAPB. If it is, it checks to see if the **Called NUA** field in the call packet matches the **LAPB 0** NUA parameter. If it does, it selects **LAPB 0** as the outgoing interface. If the **Called NUA** field does not match **LAPB 0** NUA, it checks for a match with **LAPB 1** NUA. If there is a match, it sets the outgoing interface to **LAPB 1**.
- If the **Called NUA** field in the calling packet matches neither the **LAPB 0** NUA or **LAPB 1** NUA parameters, the outgoing interface is set to the interface specified by the relevant **Switch from** parameter.
- If the call is being switched over **LAPB 0**. the router sets the **Called NUA** to the **TE NUA (LAPB 0)** value. If the call is being switched over **LAPB 1**, the router sets the **Called NUA** to the **TE NUA (LAPB 1)** value.

Configure the Protocol Switch

Web

1. Go to **Configuration > Network > Protocol Switch**.

▼ Protocol Switch

The Protocol Switch allows you switch X.25 calls received on one interface to another interface. It is also possible to specify a backup interface so that if an outgoing call on one interface fails, then the backup interface is automatically tried.

Switch from Interface	To Interface	Backup to Interface
TCP or XOT or SSL	OFF ▼	None ▼
LAPD	OFF ▼	None ▼
LAPB 0	OFF ▼	None ▼
LAPB 1	OFF ▼	None ▼
LAPB 2	OFF ▼	None ▼
LAPB 0 PVC	OFF ▼	
LAPB 1 PVC	OFF ▼	
LAPB 2 PVC	OFF ▼	
XOT PVC	OFF ▼	

LAPD Parameters

Calling Prefix:

D-Channel LCN:

D-Channel LCN Direction:

Max VCs: Unlimited

Default Packet Size:

Default Window Size:

LAPB Parameters

LCN:

LCN direction:

Max VCs: Unlimited

B-Channel Number:

Enable ENQ Char:

LAPB 0 Default Packet Size:

LAPB 0 Default Window Size:

LAPB 1 Default Packet Size:

LAPB 1 Default Window Size:

LAPB 2 Default Packet Size:

LAPB 2 Default Window Size:

IP Stream / XOT Parameters

IP Stream or XOT Remote IP Address:

IP Stream or XOT Backup IP Address:

IP Stream Port:

IP Length Header:

Source IP address interface:

X.25 Parameters

Don't switch facilities:

Don't strip facilities:

L2 Deactivation Clear Cause:

X25 Version:

Interpret no facilities on Call Accept as P7W2:

The Protocol Switch page has several following sub-menu options:

- A table for setting interface switches and backup interfaces
 - LAPD parameters
 - LAPB parameters
 - IP Stream/XOT parameters
 - X.25 parameters
2. Configure protocol switch parameters:

TCP or XoT

Controls the switching of incoming X.25 calls received via TCP or XOT. Select the interface to which data should be switched from the drop down list, or select **Off** and the protocol switch will not respond to any incoming XOT or TCP connections.

LAPD

Controls the switching of incoming X.25 calls received via ISDN LAPD. Select the interface to which data should be switched from the drop down list, or select **Off** and the protocol switch will not respond to any incoming LAPD calls.

LAPB n

Controls the switching of incoming X.25 calls received via LAPB X. Select the interface to which data should be switched from the drop down list, or select **Off** and the protocol switch will not respond to any incoming LAPB X calls.

LAPB n PVC

Controls the switching of incoming X.25 calls received via LAPB X PVC. Select the interface to which data should be switched from the drop down list, or select **Off** and the protocol switch will not respond to any incoming PVC calls on LAPB X.

XOT PVC

Controls the switching of incoming X.25 calls received via an XOT PVC. Select the interface to which data should be switched from the drop down list, or select **Off** and the protocol switch will not respond to any incoming XOT PVC calls.

Backup to interface

If any of the **Switch from** parameters has been set to **XOT**, and XOT is unavailable, you can use this parameter to specify an alternative interface to switch the X.25 call to. Any of the other interfaces can be selected, or **None**. If **None** is selected, no backup call is attempted.

LAPD backup to interface

If any of the **Switch from** parameters has been set to **LAPD**, and LAPD is unavailable, you can use this parameter to specify an alternative interface to switch the X.25 call to. Any of the other interfaces can be selected, or **None**. If **None** is selected, no backup call is attempted.

LAPB X backup to interface

If any of the **Switch from** parameters has been set to **LAPB X**, and LAPB X is unavailable, you can use this parameter to specify an alternative interface to switch the X.25 call to. Any of the other interfaces can be selected, or **None**. If **None** is selected, no backup call is attempted.

VXN backup to interface

If any of the **Switch from** parameters has been set to VXN, and VXN is unavailable, you can use this parameter to specify an alternative interface to switch the X.25 call to. Any of the other interfaces may be selected, or **None**. If **None** is selected, no backup call is attempted.

3. Configure LAPD parameters:

Calling Prefix

The call prefix to inserted in front of the NUA in calls being switched to LAPD. For example, if the called NUA in the call being received by the **LAPB 0** interface is **56565**, and the call prefix is **0242**, the call placed on the LAPD interface is to NUA **024256565**. Also, for calls in the reverse direction, if the prefix in the calling NUA matches this parameter, it is removed from the calling NUA field.

D-Channel LCN

The value of the first LCN assigned for outgoing X25 calls on LAPD.D-Channel LCN Direction.

Max VCs: Unlimited

The maximum number of Virtual Circuits (VCs) on an LAPD interface. When the maximum has been reached, the backup call will take place immediately, or the call will clear if there is no backup call. If this parameter is set to **0**, there is no limit.

Default Packet Size

The default packet size for X.25 calls being switched onto LAPD. The default packet size is **128**, other possible values are **256**, **512**, or **1024** bytes.

Default Window Size

The default window size for calls being switched onto LAPD. The default window size is **2**; the valid range is **1** to **7**.

4. Configure LAPB parameters:

LCN

The value of the first LCN that will be assigned for outgoing X25 calls on LAPB.

LCN direction: Up Down

Determines whether the LCN for outgoing X.25 calls on LAPB is incremented or decremented from the starting value.

Max VCs: Unlimited

The maximum number of Virtual Circuits (VCs) on a LAPB interface. When the maximum has been reached, then the backup call occurs immediately, or the call will clear if there is no backup call. If this parameter is set to **0**, there is no limit.

B-Channel Number

An ISDN number for calls switched in the direction of **LAPB 0** or **LAPB 1**.

Enable ENQ Char

When this parameter is set to **On**, when an incoming call on LAPB is switched and the router connects to it, the X.25 switch sends a data packet on the LAPB X.25 SVC containing the **ENQ** character.

LAPB 0 Default Packet Size: 128 256 512 1024

The default packet size for calls being switched onto **LAPB 0**. The default packet size is **128**. Other possible values are **256, 512, or 1024** bytes.

LAPB 0 Default Window Size: 2 1 3 4 5 6 7

The default window size for calls being switched onto **LAPB 0**. The default window size is **2**. The valid range is **1 to 7**.

LAPB 1 Default Packet Size: 128 256 512 1024

The default packet size for calls being switched onto **LAPB 1**. The default packet size is **128**. Other possible values are **256, 512, or 1024** bytes.

LAPB 1 Default Window Size: 2 1 3 4 5 6 7

The default window size for calls being switched onto **LAPB 1**. The default window size is **2**. The valid range is **1 to 7**.

LAPB 2 Default Packet Size: 128 256 512 1024

The default packet size for calls being switched onto **LAPB 2**. The default packet size is **128**. Other possible values are **256, 512, or 1024** bytes.

LAPB 2 Default Window Size: 2 1 3 4 5 6 7

The default window size for calls being switched onto **LAPB 2**. The default window size is **2**. The valid range is **1 to 7**.

5. Configure IP Stream / XOT parameters:

IP Stream or XOT Remote IP Address:

For calls being switched in the direction of XOT, this parameter specifies the destination IP address for the outgoing XOT call. The router also uses this value as the destination IP address in the IP/UDP stream modes.

IP Stream or XOT Backup IP Address

If the **Switch from XOT to** parameter is set to **XOT**, this is the IP address the XOT call will be switched to, if the original XOT IP address is unavailable.

IP Stream Port

The IP port number to use when **IP stream** or **UDP stream** are selected as the parameter for any of the **Switch from** or **Backup from** parameters.

Note The XOT remote IP address and IP stream port parameters are overridden by the values in the NUA/NUI to IP addresses table if the call matches any entry in that table.

IP Length Header: Off On 8583 Ascii 4 byte On (inclusive)

When IP length header is **On**, a length indicator field is inserted at the start of each packet. When set to **8583 Ascii 4 byte**, the IP length header conforms to the ISO 8583 format.

Source IP address interface: Auto Ethernet PPP

The default value for this parameter is **Auto**, which means that the source IP address of an outgoing XOT connection on an un-NATed W-WAN link is the address of the PPP interface assigned to W-WAN. This is because the XOT connection is initiated (automatically) within the

router, and does not originate from the local subnet (LAN segment to which the router is attached via the Ethernet interface). However, this means that if you are routing traffic from the local subnet across a VPN tunnel, you would have to set up two Eroutes: one to match the local subnet address, and one to match the XOT source address, such as the address of the PPP interface associated with to the wireless network. If set to **Ethernet**, the router uses the IP address of the Ethernet port instead of that of the PPP interface, so that you need only set up on Eroute.

6. Configure X.25 parameters:

Don't switch facilities

If this parameter is set to **Off**, the packet size and window size are only switched if they need to, such as if they specify a value different from what is currently being negotiated. If this parameter is set to **On**, the facilities are not switched.

Don't strip facilities

When set to **On**, this parameter stops the X.25 switch from stripping packet size and window size facilities as it switches an X.25 call. When set to **Off**, the X.25 switch strips facilities if the requested facilities match the defined defaults for that interface.

L2 Deactivation Clear Cause

When one side of a switch call fails because layer 2 drops, the other side is usually cleared with a clear **cause 9,out of order**. This parameter allows you to set this code to any value.

X25 Version: 84 88

Allows you to switch between X.25 version 88, and X.25 version 84, in which clear causes are always **0** when issued if the router is the DTE.

Interpret no facilities on Call Accept as P7W2

When this parameter is set to **On**, the X.25 switch interprets any call accept packets that do not include the window size (**W**) or packet size (**P**) as if the call accept has **P7W2**, such as a packet size of **128 bytes** and a windows size of **2**.

7. Click **Apply**.



Command line

Command	Instance	Parameter	Values	Equivalent web parameter
x25sw	0	swfrlapb0	0, 1, 3- 10, 12-15 (see below)	Switch from LAPB 0 to
x25sw	0	swfrlapb0pvc	0-5, 7-10, 12-15 (see below)	Switch from LAPB 0 PVC to
x25sw	0	swfrlapb1	0-2, 4-10, 12-15 (see below)	Switch from LAPB 1 to
x25sw	0	swfrlapb1pvc	0-6, 8-10, 12-15 (see below)	Switch from LAPB 1 PVC to

Command	Instance	Parameter	Values	Equivalent web parameter
x25sw	0	swfrlapb2	0-10, 13-15 (see below)	Switch from LAPB 2 to
x25sw	0	swfrlapb2pvc	0-10, 12, 14, 15 (see below)	Switch from LAPB 2 PVC to
x25sw	0	swfrlapd	0, 2-10, 12-15 (see below)	Switch from LAPD to
x25sw	0	swfrxot	0-3, 5-10, 12-15 (see below)	Switch from XOT (TCP) to
x25sw	0	swfrxotpvc	0-7, 9, 10, 12-15 (see below)	Switch from XOT PVC to
x25sw	0	callprefix	<NUA>	Calling Prefix
x25sw	0	dlcn	0-65535	D-Channel LCN
x25sw	0	dlcnup	off, on Off=Down On=Up	D-Channel LCN Direction
x25sw	0	dmaxvc	0-65535	Max VCs
x25sw	0	lapb0ppar	7, 8, 9, 10 7=128 8=256 9=512 10=1024	Default Packet Size
x25sw	0	lapb0wpar	1-7	Default Window Size
x25sw	0	blcn	0-65535	LCN
x25sw	0	blcnup	off, on Off=Down On=Up	LCN direction
x25sw	0	bmaxvc	0-65535	Max VCs
x25sw	0	bnumber	ISDN number	B-Channel Number
x25sw	0	benqcon	off, on	Enable ENQ Char
x25sw	0	lapdppar	7, 8, 9, 10 7=128 8=256 9=512 10=1024	LAPB 0 Default Packet Size
x25sw	0	lapdwpar	1-7	LAPB 0 Default Window Size

Command	Instance	Parameter	Values	Equivalent web parameter
x25sw	0	lapb1ppar	7, 8, 9, 10 7=128 8=256 9=512 10=1024	LAPB 1 Default Packet Size
x25sw	0	lapb1wpar	1-7	LAPB 1 Default Window Size
x25sw	0	lapb2ppar	7, 8, 9, 10 7=128 8=256 9=512 10=1024	LAPB 2 Default Packet Size
x25sw	0	lapb2wpar	1-7	LAPB 2 Default Window Size
x25sw	0	ipaddr	IP address	IP Stream or XOT Remote IP Address
x25sw	0	buipaddr	IP address	IP Stream or XOT Backup IP Address
x25sw	0	ip_port	0-65535	IP Stream Port
x25sw	0	iphdr	0, 1, 2 0=Off 1=On 2=8583 Ascii 4 byte	IP Length Header
x25sw	0	srcipadd	Interface number 0-65535	Source IP address interface
x25sw	0	srcipent	<blank>, PPP, ETH	Source IP address interface
x25sw	0	noswfac	off, on	Don't switch facilities
x25sw	0	nostripfac	off, on	Don't strip facilities
x25sw	0	l2deactcc	0-65535	L2 Deactivation Clear Cause
x25sw	0	x25ver84	off, on Off=88 On=84	X25 Version
x25sw	0	accdefp7w2	off, on	Interpret no facilities on Call Accept as P7W2

Interfaces are coded as follows:

Parameter value	Interface type
0	None

Parameter value	Interface type
1	LAPD
2	LAPB 0
3	LAPB 1
4	XOT
5	LAPD X (actual instance is determined by NUA)
6	LAPB 0 PVC
7	LAPB 1 PVC
8	XOT PVC
9	TCP stream
10	UDP stream
12	LAPB 2
13	LAPB 2 PVC
14	VXN
15	SSL

Answering NUAs programmed on active PADs

Because the other interfaces can operate as normal, even when the switch is operating, take special care in answering NUAs programmed on active PADs. For example, when a call is being received on a LAPD or LAPB interface, a PAD instance or remote configuration session can answer and terminate the call in preference to the call being switched. This means that you should leave the PADs

Answering NUA parameters blank to ensure that the router's PADs are not answering calls that need to be switched. If you do want a PAD instance to answer a call, program the **Answering NUA** field with as many digits as you can to ensure it only answers calls destined for that PAD.

These same precautions apply to the **Allow CLI access from X.25 address** parameter on the web interface **Configuration > System > General** page.

Configure CUD mappings parameters

Protocol Switch CUD mappings allow you to map an incoming call's CUD (call user data) from one value to another. The PID (protocol identifier) portion of the CUD, if present, is maintained from input to output and is not involved in the comparison.

Web

1. Go to **Configuration > Network > Protocol Switch > CUD Mappings**.

▼ CUD Mappings

You can specify up to 10 CUD mappings

CUD In	CUD Out	Interface
No CUD mappings have been configured.		
<input type="text"/>	<input type="text"/>	ANY ▼ <input type="button" value="Add"/>

2. Enter CUD mappings. The CUD Mappings page displays a table with four columns in which you can specify the **CUD In** values, corresponding **CUD Out** values and to which interfaces the mappings should be applied. The **interface** field defines which output interfaces this mapping applies to. Wildcard characters are allowed, and in each case the interface type to which the mapping applies can be selected from **ANY**, **LAPD**, **LAPB0**, **LAPB1**, **LAPB2**, or **XOT**.
3. Click **Add** to add each CUD mapping.
4. Click **Apply**.

Command line

Command	Instance	Parameter	Values	Equivalent web parameter
cudmap	0-9	cudfrom	0-65536	CUD In
cudmap	0-9	cudto	0-65536	CUD Out
cudmap	0-9	Interface	0, 1, 2, 3, 4, 12 0=Any 1=LAPD 2=LAPB 0 3=LAPB 1 4=XOT 12=LAPB 2	Interface

Configure IP sockets to protocol switch

Web

- Go to **Configuration > Network > Protocol Switch > IP Sockets to Protocol Switch**.

▼ **IP Sockets to Protocol Switch**

Total sockets: 128
Sockets available: 123

(You can specify up to 50 IP Sockets to Protocol Switch mappings)

Port	Number of Sockets	X25 Call	PID	Confirm Mode	SSL Mode	IP Length Header
No IP Socket mappings have been configured.						
2004	3	jollyroger	1,0,0,0	<input type="checkbox"/>	<input type="checkbox"/>	Off ▼
<input type="button" value="Add"/>						

The IP Sockets to Protocol Switch page contains a table for entering a series of IP Port numbers and X.25 Call strings, as shown below. It configures the router so IP data can be switched to any of the protocols support by the protocol switch, including X.25. For example, data received on a TCP connection can be forwarded over SSL, XoT, or a UDP stream. The only columns that must be filled out are **Port** and **Number of Sockets**.

This table is duplicated in the **Configuration > Network > Legacy Protocols > X.25 > IP to X.25 Call** section, as it can also convert an incoming TCP connection to an X.25 session to be answered by PAD without using the protocol switch. It is included at this point in the web user interface as a convenience, in case you are using the table with PAD and not the protocol switch.

IP Port

Used to set up the port numbers for those IP ports that will listen for incoming connections to be switched over X.25 or other protocol. In the case of switching to X.25, when such a connection is made, the router makes an **X.25 Call** to the address specified in the **X.25 Call** field. Once this call has been connected, data from the port is switched over the X.25 session.

Number of Sockets

How many IP sockets should simultaneously listen for data on the specified port. The number of available IP sockets depend on your router model and how many are already in use. See note at the end of these settings descriptions.

X25 Call

The X.25 call field may contain an X.25 NUA or NUI or one of the X.25 Call Macros defined on the **Configuration > Advanced applications > X25 > Macros** page.

PID

The Protocol Identifier (PID) to use when the router switches an IP connection to X.25. The **PID** (protocol ID) field takes the format of four hexadecimal digits separated by commas, such as **1,0,0,0**, at the start of the **Call User Data** field in the X.25 call.

Confirm Mode

When set to **On**, the incoming TCP socket is not successfully connected until the corresponding outgoing call has been connected. The incoming TCP socket triggers the corresponding

outgoing call either to a local PAD instance or to whatever is configured. The effect of this mode is that the socket fails if the outbound call fails and so may be useful in backup scenarios. In addition it ensures that no data is sent into a “black hole”. When this setting is not enabled, data sent on the inbound TCP connection before the outbound connection has been successful can be lost.

RFC 1086 Mode:

RFC 1086 specifies a mode of operation in which the IP socket answers, and then, with a simple protocol in the socket, identifies the X.25 address and other X.25 call setup parameters to use. When the X.25 call parameters have been identified, the X.25 call is made. If successful, data is switched between the X.25 call and the IP socket. The protocol selects whether incoming or outgoing support is required.

SSL Mode

If enabled, the router operates similarly to the TCP Stream interface, except that it negotiates SSL over the socket, and encrypts all user data.

IP length header

When IP length header is **On**, the IP length indicator field is inserted at the start of each packet. When set to **8583 Ascii 4 byte**, the IP length header conforms to the ISO 8583 format. In the example above, 3 IP sockets will listen for an incoming connection on IP Port **2004**. Once connected, they each make an X.25 Call to **jollyroger**. The router recognizes that **jollyroger** is a pre-defined macro, as illustrated below, and translates it into an X.25 Call to address **32423** with the string **x25 data** included as data in the call. The outgoing X.25 call(s) are made over whichever interface is specified by the **Switch from XOT(TCP)** to parameter on the **Configuration > Network > Protocol Switch** page.

Call Macros

X.25 Call Macros can be used to initiate ISDN and/or X.25 layer 3 calls.

You can configure up to 64 macros

Macro	Command	
jollyroger	=32423Dx25data	Delete
		Add

Note At the top of the page, the total number of sockets available and the number currently free is shown. Take care to not allocate too many of the free sockets, unless you are confident they are not required for other applications.

2. Click **Add** to add each IP sockets to protocol mapping.
3. Click **Apply**.

**Command line**

Command	Instance	Parameter	Values	Equivalent web parameter
ipx25	n	ip_port	0-65535	IP Port
ipx25	n	nb_listens	0-software-dependent max	Number of Sockets
ipx25	n	x25call	NUA, NUI or X.25 macro name	X25 Call
ipx25	n	pid	hex numbers	PID
ipx25	n	cnf_mode	1=enabled, 0=disabled	Confirm Mode
x25sw	n	swfrxot	15	SSL Mode
ipx25	n	rfc1086_mode	1=enabled, 0=disabled	RFC 1086 Mode
ipx25	n	iphdr	0=Off 1=On 2=8583 Ascii 4 byte	IP length header

Configure NUA to interface mappings

Web

1. Go to **Configuration > Network > Protocol Switch > NUA to Interface Mappings**.

▼ NUA to Interface Mappings

(You can specify up to 10 NUA to Interface mappings)

NUA	IP Address	IP Port	Interface	Backup Interface	
No NUA to Interface mappings have been configured.					
<input type="text"/>	<input type="text"/>	<input type="text"/>	Default ▼	Default ▼	Add

2. Enter NUA to interface mappings. The **NUA to Interface Mappings** page contains a table to enter a series of X.25 NUA or NUI values along with IP addresses/Ports to which they should be mapped, if you need to override the default settings in the **Configuration > Network > Legacy Protocols > X.25 > NUA/NUI Interface Mappings** page.

If, in the **Protocol Switch** configuration, you had configured the router to switch from **LAPB 0** to **TCP**, the **IP Address** and **Port** values would normally be determined from the **XOT Remote IP address** and **IP stream port** parameters. However, having set up the NUA/NUI to IP addresses table as shown in the example above, if an X.25 call with NUA of value **222** is received on **LAPB 0**, it is switched onto a TCP socket using IP address **1.2.3.4** on port **45** instead of the settings configured on the Configuration > Network > Legacy Protocols > X.25 > NUA/NUI Interface Mappings page.

Similarly, NUIs can also be matched. In this example, a call with NUI of value **test** is switched onto a TCP socket using IP address **100.100.100.1** on port **678**.

All three comparison fields, NUA, NUI and Call Data can use the wildcard matching characters **?** and *****. In the example shown above, when an X.25 call is received with either the NUA having **1234** followed by any 2 digits or a call being received with call user data with any 4 characters followed by **aa**, the call is switched to a TCP socket on address **100.100.100.52** on port **4001**.

When a connection has been successfully established and data is being switched from the X.25 call to the socket and from the socket to the X.25 connection, it can be terminated by either the socket closing or the X.25 call clearing.

If the connection terminates because of an incoming X25 **CALL CLEAR** packet, the switch terminates the socket connection. If the connection terminates because the socket is closed, the switch clears the X.25 call by transmitting a **CALL CLEAR** packet.

3. Click **Add** to add each NUA to interface mapping.
4. Click **Apply**.

Command line

Command	Instance	Parameter	Values	Equivalent web parameter
nuaip	0-255	nua	0-65536	NUA

Command	Instance	Parameter	Values	Equivalent web parameter
nuaip	0-255	ipaddr	IP address	IP Address
nuaip	0-255	ip_port	0-65536	IP Port
nuaip	0-255	swto	0-10, 12-15 (see table below)	Interface
nuaip	0-255	buswto	0-10, 12-15 (see table below)	Backup Interface

Interfaces are as follows:

Parameter Value	Interface Type
0	Default
1	LAPD
2	LAPB 0
3	LAPB 1
4	XOT
5	LAPD X (actual instance determined by NUA)
6	LAPB 0 PVC
7	LAPB 1 PVC
8	XOT PVC
9	TCP stream
10	UDP stream
12	LAPB 2
13	LAPB 2 PVC
14	VXN
15	SSL

Configure NUA mappings

Protocol switch NUA mappings allow you to redirect specified NUAs to alternative NUAs for switched X.25 calls. Up to 20 **NUA In** to **NUA Out** mappings are available. These mappings alter the **called NUA** field in any X.25 call. The comparison uses tail matching, so only the rightmost digits in the NUA are compared with the table entry.

Web

1. Go to **Configuration > Network > Protocol Switch > NUA Mappings**.

▼ NUA Mappings

You may specify up to 20 NUA mappings

NUA In	NUA Out	Interface	Called / Calling
No NUA mappings have been configured.			
<input type="text"/>	<input type="text"/>	ANY ▼	Both ▼ <input type="button" value="Add"/>

The **NUA Mappings** page displays a table with four columns in which you can specify the **NUA In** values, corresponding **NUA Out** values, to which interfaces the mappings should be applied, and whether the mapping should apply if the router is making the call, receiving the call, or both.

For example, if the called NUA is **123456789345** and there is an NUA In table entry of **9345**, with **Called/Calling** set to either **Both** or **Called**, this will match, and the entire called NUA will be replaced with the corresponding **NUA Out** entry. In each case, the interface type to which the mapping applies can be selected from **ANY**, **LAPD**, **LAPB0**, **LAPB1**, **LAPB2**, or **XOT**.

2. Click **Add** to add each NUA to mapping.
3. Click **Apply**.

Command line

Command	Instance	Parameter	Values	Equivalent web parameter
x25map	0-19	nuafrom	0-65536	NUA In
x25map	0-19	nuato	0-65536	NUA Out
x25map	0-19	interface	0, 1, 2, 3, 4, 12 0=Any 1=LAPD 2=LAPB 0 3=LAPB 1 4=XOT 12=LAPB 2	Interface
x25map	0-19	ca_or_ci	0, 1, 2 0=Both 1=Called 2=Calling	Called / Calling

Configuring alarms

Configure events to trigger alarms	680
Edit event descriptions	696
Configure an SMTP email account to send alarms	703

Configure events to trigger alarms

The router maintains a log of events in the **logcodes.txt** pseudo file. When an event of a specified or lower priority level occurs, a syslog message, an email alert, or SMS alert can be sent to a pre-defined address.

Web

- Go to **Configuration > Alarms > Event Settings**. The **Event Settings** page has several sub-menu items:
 - Email Notifications
 - SNMP Traps
 - SMS
 - Local Logging
 - Syslog Messages
 - Syslog Server *n* pages

Configuration - Alarms > Event Settings

▼ Event Settings

Only log events with a log priority of at least

Do not log the following events:

After power up, wait seconds before sending Emails, SNMP traps, SMS or Syslog messages

Include event number in the event log and Email, SNMP traps, SMS or Syslog messages

- [▶ Email Notifications](#)
- [▶ SNMP Traps](#)
- [▶ SMS](#)
- [▶ Local Logging](#)
- [▶ Syslog Messages](#)
- [▶ Syslog Server 0](#)
- [▶ Syslog Server 1](#)
- [▶ Syslog Server 2](#)
- [▶ Syslog Server 3](#)
- [▶ Syslog Server 4](#)

- Set the following parameter values:

Only log events with a log priority of at least *n*

Enables a filter that ensures that only events having a specified severity or lower level are logged.

Do not log the following events

A numerical list of comma-separated values specifying events to be excluded from the log. These numerical values can be found in the eventlog.txt file on the router.

After power up, wait *s* seconds before sending Emails, SNMP traps, SMS or Syslog messages

The delay, in seconds, after power-up that the router should wait before sending any alert messages. This is useful when the sending of those items would fail if sent too soon after the router powers up because the underlying interface to use has not completed initialization.

Include event number in the event log and Email, SNMP traps or Syslog messages

If enabled, event numbers from the **logcodes.txt** file are included.

3. Click **Apply**.

Command line

Command	Instance	Parameter	Values	Equivalent web parameter
event	n	loglevel	0-9 0 none 1 low 9 high	Only log events with a log priority of at least n
event	n	ev_filter	Comma-separated list of event numbers	Do not log the following events.
event	n	action_dly	Number of seconds (such as 60)	After power up, wait s seconds before sending Email, SNMP traps, SMS or Syslog messages.
event	n	incevnums	0, 1	Include event number.

Configure sending email alert messages when events occur

About using email templates

One of the key features provided by the event log function is the ability to configure the router to automatically generate and send an email alert message each time an event of up to a specified priority occurs. The format of the message is determined by the email template specified in the **Use email template file** parameter, normally **event.eml**, and on the **Configuration > Alarms > Event Settings > Email Notifications** web page.

If the standard **event.eml** template supplied with the router is not suitable, you can create your own template. An email template is a text file that defines the appearance and content of the email messages generated by the event logger.

Email template structure

An email template consists of a header section followed by a body section. One or more blank lines separate the two sections.

Header section

The header section **MUST** contain the following three fields:

TO

Used to specify at least one recipient's email address. Multiple addresses may be included and must be separated by a space, comma or semicolon character. For example:

To: 123@456.com, 456@123.com; abc.def.com

FROM

The email address of the sending unit. Alternatively, you can enter a simple string. This may depend on the SMTP server as to what is accepted. For example:

FROM: WR44

Or:

FROM: wr44@mycompany.com

SUBJECT

A string describing the subject of the email message. For example:

Subject: Automated message from router

Other fields

In addition to the required fields described above, the header section of an email can also contain one or more optional fields. Many such fields are defined in the relevant RFCs, but there are some fields the router handles a little differently, as described below. The router inserts other fields as necessary if it is required to send attachments with the email.

Reply To

If the router discovers this field is not present in the email template, it inserts this field into the header. The string for this field is the one configured by the **smtp 0 reply_to** CLI command (or the use **Reply To** address parameter in the **Configuration > Alarms > SMTP Account** web page). This allows

for different reply addresses, and a simple way of using the same (easily configurable) reply address for all emails.

Date

If this field is present in the header, the router inserts the current date and time into the header. The date and time are values local to the router and do not contain any time zone information.

Body section

The body section can include any text. This text is parsed for any function calls that may be present. Function calls must be enclosed between `<%` and `%>`. These sequences are substituted by text resulting from the function call. You can use the following functions:

Function	Description
TimeSMTP();	Inserts the router's date and time.
serial_number();	Inserts the router's serial number
SMTPip();	Inserts the IP address of the router as seen by the SMTP server during transmission
email_event()	Inserts a formatted description of the event that caused the email transmission.
SMTPid()	Inserts the router ID for this device as configured by the Router Identity field in the Configuration > System > Device Identity web page, or the cmd 0 unitid CLI command.
pppip("instance");	Inserts the IP address for a specific PPP instance, where instance is the PPP instance number.

Example email templates

Following are examples of email templates.

Example 1

```

TO: 123@abc.co.nz
FROM: MyRouter
SUBJECT: Remote Configuration
< This blank line is required
Time: <%timeSMTP();%>
Serial Number: <%serial_number();%>
Req: CFG_RQ
IP Address: <%SMTPip();%>
PPP 1 IP address: <%pppip("1");%>

```

Example 2

```

TO: fred@anyco.com, jane@anyco.co.uk
FROM: MyRouter
SUBJECT: automatic email
MIME-Version: 1.0
< This blank line is required
Unit: <%SMTPid();%>
Event: <%email_event();%>

```

This event had sufficient priority to cause the transmission of this email. Please check the attached logs and review.

Include the output from CLI commands in the email body

You can also execute CLI commands and include their output within the email; the output from up to 10 CLI commands will be added to the body of the email. The command to be executed needs to be entered in place of **xxxxx** below. To include the output from multiple commands, use the **run_cmd()** function multiple times.

The **run_command()** function is as follows:

```
<%run_cmd("xxxxx");%>
```

For example,

```
<%run_cmd("ati5");%>
<%run_cmd("bufs");%>
<%run_cmd("msgs");%>
```

For example, here is a template adding CLI commands:

```
TO: fred@anyco.com, jane@anyco.co.uk
FROM: MyRouter
SUBJECT: automatic email
MIME-Version: 1.0
Unit: <%smtpid();%>
Event: <%email_event();%>
This event had sufficient priority to cause the transmission of this email.
Please check the attached logs and review.
<%run_cmd("ati5");%>
<%run_cmd("bufs");%>
<%run_cmd("msgs");%>
```

You can also specify an extra parameter which indicates the required priority of the event before the command is executed. This allows events to be sent off without attachments, but if the event has an equal or higher priority than the value of this parameter, the attachments are included. This ensures that the attachments are not included unnecessarily with non-critical events and using up all the data allowance on a wireless connection.

```
<%run_cmd("chkst", "5");%>
```

An example template adding CLI commands with priority values is:

```
TO: fred@anyco.com, jane@anyco.co.uk
FROM: MyRouter
SUBJECT: automatic email
MIME-Version: 1.0
Unit: <%smtpid();%>
Event: <%email_event();%>
```

This event had sufficient priority to cause the transmission of this email. Please check the attached logs and review.

```
<%run_cmd("chkst", "5");%>
```

In the example above, the command **chkst** is executed when an event with a priority equal to or higher than **5** is detected.

Web

1. To use the email alert facility, go to **Configuration > Alarms > SMTP Account**.
2. Specify a valid **Dial-out number**, **Username**, and **Password**, and set the SMTP parameters correctly. The **Dial-out number**, **Username** and **Password** parameters should match the values on the on the **Configuration > Network > Interfaces > Advanced > PPP n** pages where **n** is the relevant interface number.
2. Go to **Configuration > Alarms > Event Settings > Email Notifications**.
3. Enable the **Send email notifications setting**.

▼ Email Notifications

Send email notifications

Send an email notification when the alarm priority is at least

Send a maximum of emails per day

0 emails have been sent today

Use email template file

Email To:

Email From:

Email Subject:

In order to send email notifications, a SMTP account must be configured.

4. Set email notifications parameters:

Send email notifications

Enables the display of the configurable parameters when checked.

Send an email notification when the event priority is at least n

The lowest priority event that will generate an email alert message. For example, if this value is set to **6**, only events with a priority of **6** or lower (**7**, **8**, or **9**) trigger an automated email alert message. To disable email alarms, set this value to **0**.

Send a maximum of n emails per day

The limit on the number of emails that can be sent during any 24-hour period. The intention is to prevent excessive alerts being sent when the event trigger value is set to a high priority / low value (for example, **1**, **2**, or **3**), such as a value that results in a large number of automated email alert messages being generated. A maximum of **255** emails can be sent in a day.

n emails have been sent today

A status message, indicating how many emails have been sent during the last 24-hour period.

Use email template file

The name of a template file to form the basis of any email alert messages generated by the event logger. The default template is a file called **event.eml** stored in the compressed **.web** file. You can create alternative template, but to be valid, it must have the **.eml** file extension and be stored in the normal file directory. A new template with the name **event.eml** takes precedence over the predefined **event.eml** template, but it is recommended to use a new name, such as **event1.eml**.

Email To

The standard email address format for the intended recipient of the alert.

Email From

A valid email address that will be accepted by the SMTP server as being authorized to send email.

Email Subject

A short description of the email content.

5. Click **Apply**.

**Command line**

Command	Instance	Parameter	Values	Equivalent web parameter
event	n	etrig	0-9 0 disables sending alerts	Send an email notification when the event priority is at least n
event	n	emax	0-255	Send a maximum of n emails per day
event	n	etemp	The name of a template file. Default is event.eml	Use email template file
event	n	to	A valid email address, such as you@yourdomain.com	Email To
event	n	from	A valid email address	Email From
event	n	subject	A brief description of the content of the email	Email Subject

Configure SNMP traps

The router firmware supports the use of SNMP, with the ability to generate traps. To make the SNMP (Simple Network Management Protocols) functional, you must configure a SNMP trap server.

Web

1. Go to **Configuration > Remote Management > SNMP > SNMP Traps**.
2. Specify which types of SNMP traps you want to generate:

Generate Enterprise traps

Enables or disables generation of enterprise traps.

Generate Generic traps

Enables or disables generation of generic traps.

Generate Authentication Failure traps

Enables or disables generation of authentication failure traps.

Generate VRRP traps

Enables or disables generation of VRRP traps.

3. In **SNMP Trap Server 0**, configure the settings for SNMP trap server **0**:

Trap Server IP Address

The IP address for the SNMP trap server.

Port

The network port number for the SNMP trap server.

Use interface *interface-type interface-number* for the source IP address

The interface type and number to use for the source IP address. interface-type can be **Auto**, **PPP**, or **Ethernet**.

Use SNMP Version

The SNMP version to use (SNMPv1, SNMPv2c, or SNMPv3).

Send "Inform Request" message

Enables or disables sending the trap as an Inform Request message, which requires an acknowledgment from the recipient. If this setting is enabled, these settings are displayed:

If no response, retransmit the Inform Request message after n seconds

Sets the Inform Request to retransmit if there is no response from the recipient after the specified number of seconds.

Retransmit a maximum n times

Sets the number of times to retransmit the Inform Request message.

Community / Confirm Community

For SNMPv1 and SNMPv2c, these settings specify the SNMPv1 or SNMPv2c community name.

Username

The SNMPv3 user name.

Authentication

The SNMPv3 authentication type: **None**, **MD5**, **SHA1**, or **SHA256**.

Authentication Password / Confirm Authentication Password

The SNMPv3 authentication password.

Encryption

The SNMPv3 encryption type: **None**, **DES**, or **AES**.

Encryption Password / Confirm Encryption Password

The SMPv3 encryption password.

4. Click **Apply**.

**Command line**

Command	Instance	Parameter	Values	Equivalent web parameter
snmp	0	enterprisetrap	off, on	Generate Enterprise traps
snmp	0	generictraps	off, on	Generate Generic traps
snmp	0	authtraps	off, on	Generate Authentication Failure traps
snmp	0	vrrptraps	off, on	Generate VRRP traps
snmptrap	0	ipaddr	IP address	Trap Server IP Address
snmptrap	0	port	network port number	Port
snmptrap	0	version		Use SNMP Version
snmptrap	0	sendinforms	off, on	Send "Inform Request" message
snmptrap	0	informto	integer	If no response, retransmit the Inform Request message after n seconds
snmptrap	0	informretries	integer	Retransmit a maximum n times
snmptrap	0	auth	none, md5, sha1, sha256	Authentication
snmptrap	0	authpassword	password	Authentication Password

Command	Instance	Parameter	Values	Equivalent web parameter
snmptrap	0	priv		
snmptrap	0	privpassword	password	
snmptrap	0	ipent		
snmptrap	0	ipadd		

Send SMS alert messages when events occur

Web

1. Go to **Configuration > Alarms > Event Settings > SMS**.

The **SMS** page has three identical rows, each of which controls setting SMS alert messages.

▼ SMS	
Send SMS messages to <input type="text"/>	if the alarm priority is at least <input type="text" value="0"/>
Send SMS messages to <input type="text"/>	if the alarm priority is at least <input type="text" value="0"/>
Send SMS messages to <input type="text"/>	if the alarm priority is at least <input type="text" value="0"/>
Use SMS template <input type="text"/>	
Send a maximum of <input type="text" value="5"/> SMS messages per day	
0 SMS messages have been sent today	

Note The SMS Messages option is only available on routers with W-WAN capability.

2. Enter SMS message settings:

Send SMS messages to

The destination telephone number (MSISDN) for SMS alert messages. The format for this field is the international dialing code followed by the number, but should not contain a + prefix. For example, UK mobile **07871 445677** would be **447871445677**.

If the event priority is at least n

Sets the trigger level for the alert message. For example, if this field is set to the value **6**, only events with a priority of **6** or higher will trigger an automated SMS alert. Setting this field to **0** disables sending SMS alerts.

Use SMS template

The name of the template file to form the basis of any alarm messages generated by the event logger. The default template file is a file called **event.sms** that is stored in the compressed **.web** file. A new template can be created, and if named **event.sms**, it takes precedence over the pre-defined **event.sms** template. However, it is recommended to use a new name, such as **event1.sms**. Templates should use the **.sms** file extension.

Send a maximum of n SMS messages per day

Limits the number of SMS alert messages sent by the router in any one day. A maximum of **65535** SMS messages can be sent in a day.

n SMS messages have been sent today

A status message, indicating how many SMS alert messages have been sent during the last 24-hour period.

3. Click **Apply**.



Command line

Command	Instance	Parameter	Values	Equivalent web parameter
event	n	sms_to	A valid mobile number such as 447871445677	Send SMS messages to
event	n	sms_trig	0-9	If the event priority is at least n
event	n	sms_to2	A valid mobile number such as 447871445677	Send SMS messages to
event	n	sms_trig2	0-9	If the event priority is at least n
event	n	sms_to3	A valid mobile number such as 447871445677	Send SMS messages to
event	n	sms_trig3	0-9	If the event priority is at least n
event	n	sms_temp	event.sms (The template file stored in the compressed .web file)	Use SMS template
event	n	sms_max	0-65535	Send a maximum of n SMS messages per day

Log events to a secondary log file on an external flash drive

You can create a secondary log file on a USB flash drive to which the router logs events. Using a secondary log file is useful if an extended logging period is required where, the normal **eventlog.txt** file would overwrite early events before the operator has had a chance to view them. The secondary log file can be limited in size or allowed to fill the USB flash drive. Once the log file is full, earlier events are pruned from the end of the file to allow new events to be added.

Web

1. Go to **Configuration > Alarms > Event Settings > Local Logging**.

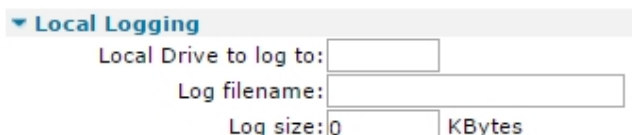

The screenshot shows a configuration panel titled "Local Logging" with three input fields: "Local Drive to log to:" (empty), "Log filename:" (empty), and "Log size:" (set to 0) followed by "KBytes".

2. Enter local logging settings:

Local Drive to log to

Determines the drive letter where the USB flash drive is located. This is designated **u** for a USB drive.

Log filename

The name of the file for the secondary event log.

Log size

The maximum size of the log file in kilobytes.

XML logs

On platforms that support it, event logs can be saved in XML format. This field specifies the size of the XML log file, in kilobytes. The files created will be named **evxml1.xml**, **evxml2.xml**, etc.

3. Click **Apply**.

Command line

Command	Instance	Parameter	Values	Equivalent web parameter
event	n	logdrive	Drive letter, such as u for USB flash drive.	Local drive to log to
event	n	logfile	Name of the file, such as mylog.txt .	Log filename
event	n	logsizek	Size of log in kilobytes, such as 1048576 , which is 1 MB.	Log size
event	n	xmllogs		None

Log events to a Syslog server

Besides logging events to an internal log file and to a file on a USB flash drive, the router can log events to a Syslog server.

Web

1. Go to **Configuration > Alarms > Event Settings > Syslog Messages**.

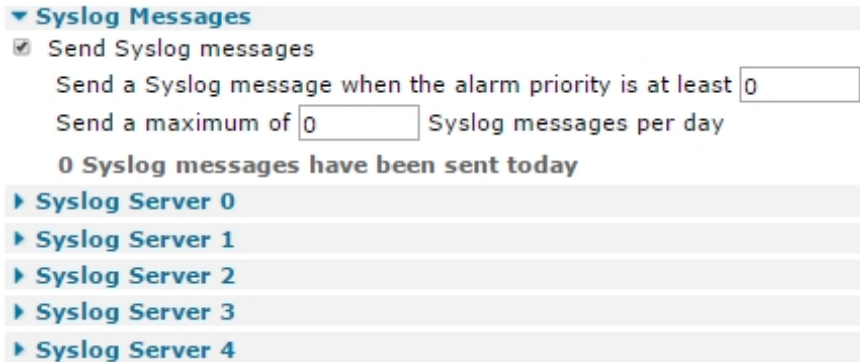

▼ **Syslog Messages**

Send Syslog messages

Send a Syslog message when the alarm priority is at least

Send a maximum of Syslog messages per day

0 Syslog messages have been sent today

▶ Syslog Server 0

▶ Syslog Server 1

▶ Syslog Server 2

▶ Syslog Server 3

▶ Syslog Server 4

2. Configure Syslog server message settings:

Send Syslog messages

When enabled, displays the following options:

Send a Syslog message when the event priority is at least n

The lowest-priority event that will generate a syslog message. For example, if this value is set to **6**, only events with a priority of **6** or lower (**7**, **8**, or **9**) will trigger an automated syslog message. To disable syslog messages, set this value to **0**.

Send a maximum of n Syslog messages per day

Sets the limit on the number of syslog messages that may be sent during any 24-hour period. The intention is to prevent excessive alerts being sent when the event trigger value is set to a high priority/low value (**1**, **2**, or **3** for example), such as a value that results in a large number of syslog messages being generated. A maximum of **2147483647** Syslog messages can be sent in a day.

n Syslog messages have been sent today

A status message that indicates how many Syslog messages have been sent in the last 24-hour period.

3. Click **Apply**.

 **Command line**

Command	Instance	Parameter	Values	Equivalent web parameter
event	n	syslog_trig	0-9	Send a Syslog message when the event priority is at least n.
event	n	syslog_max	0-2147483647	Send a maximum of n Syslog messages per day.

Configure the Syslog server to which messages are sent

 **Web**

Go to **Configuration > Alarms > Event Settings > Syslog Server n**.

▼ Syslog Server 0

Syslog Server IP Address: Port

Mode:

TCP timeout: seconds

Route using: Routing table
 Interface

Priority:

<input checked="" type="checkbox"/> Emergency	<input checked="" type="checkbox"/> Alert	<input checked="" type="checkbox"/> Critical	<input checked="" type="checkbox"/> Error
<input checked="" type="checkbox"/> Warning	<input checked="" type="checkbox"/> Notice	<input checked="" type="checkbox"/> Info	<input checked="" type="checkbox"/> Debug

Facility:

<input checked="" type="checkbox"/> Kernel	<input checked="" type="checkbox"/> User	<input checked="" type="checkbox"/> Mail	<input checked="" type="checkbox"/> System
<input checked="" type="checkbox"/> Auth	<input checked="" type="checkbox"/> Syslog	<input checked="" type="checkbox"/> Lpnr	<input checked="" type="checkbox"/> Nnews
<input checked="" type="checkbox"/> Uucp	<input checked="" type="checkbox"/> Clock	<input checked="" type="checkbox"/> Auth2	<input checked="" type="checkbox"/> FTP
<input checked="" type="checkbox"/> NTP	<input checked="" type="checkbox"/> Log Audit	<input checked="" type="checkbox"/> Log Alert	<input checked="" type="checkbox"/> Clock 2
<input checked="" type="checkbox"/> Local 0	<input checked="" type="checkbox"/> Local 1	<input checked="" type="checkbox"/> Local 2	<input checked="" type="checkbox"/> Local 3
<input checked="" type="checkbox"/> Local 4	<input checked="" type="checkbox"/> Local 5	<input checked="" type="checkbox"/> Local 6	<input checked="" type="checkbox"/> Local 7

Syslog Server IP Address

The IP address of the server.

Port

The port to use.

Note The following three items (**Mode**, **TCP timeout**, and **Route**) only appear on routers with TCP logging software option enabled, which is not a common option.

Mode

There are currently three supported communication modes; these are selected from a drop-down list and are **TCP**, **UDP**, and a protocol described in *IETF RFC 3195*.

TCP timeout s seconds

For TCP communications, this parameter sets the timeout on the socket.

Route using

These radio buttons select which method of establishing a route to the server to use.

Routing table

When this radio button is selected, the routing table determines the interface that to use for transmitting the syslog message.

Interface x,y

If you choose to not use the routing table, you can select an interface type (**PPP** or **Ethernet**) from the drop-down selection box, and the interface instance number can be typed into the adjoining text entry box. That interface then determines the route.

Priority

Select the event priorities that should cause the event to be logged.

Facility

Select which of the router facilities should be logged.



Command line

Entity	Instance	Parameter	Values	Equivalent web parameter
syslog	n	server	IP address	Syslog server IP address
syslog	n	port	IP port number	Port
syslog	n	mode	UDP, TCP, RFC3195	Mode
syslog	n	tcp_to	Timeout in seconds, such as 86400 .	TCP timeout s seconds
syslog	n	source_ent	PPP, ETH	Interface x,y x=Interface type
syslog	n	source_add	0-4	Interface x,y y=interface number
syslog	n	priority	Hyphen separated 0-7 Comma-separated 0, 3, 5 or all	Priority checkboxes.
syslog	n	facility	Hyphen-separated 0-23 Comma-separated 4, 3, 5, 10, 15, 22 or all	Facility checkboxes.

Edit event descriptions

Web

On the **Event Logcodes** page, you can edit the logcodes that describe events entered in the **eventlog.txt** file. If a change is made to the **logcodes.txt** file, the changes are saved in the file **logcodes.d**, so that when a firmware upgrade is performed, the changes to the logcodes are retained. The **Event Logcodes** page initially shows a table containing the event descriptions and reason. Clicking on any of the items that are links in the table opens a configuration page associated with that item. The newly-opened page allows that item to be configured. The configuration options shown on that page are described below.

Configuration - Alarms > Event Logcodes

311	Telit FW update started: %c		
312	Telit FW update completed: %c		
313	Telit FW update failed: %c		
314	ETH %a cable disconnect		
315	ETH %a cable connect		
316	Set %e %a backoff timing: %c		
317	%c		
318	Power control changed CPU speed	1	High
		2	Medium
		3	Low
319	Power control turned off subsystem	1	LEDs
		2	Ethernet
		3	Mobile Module
		4	GPS
		5	Wi-Fi
		6	DSL
		7	USB
320	Power control turned on subsystem	1	LEDs
		2	Ethernet
		3	Mobile Module
		4	GPS
		5	Wi-Fi
		6	DSL
		7	USB
321	Login from %c		
322	WEB form missing CSRF token		
323	Entropy init timeout		
324	Entropy init OK (%c)		
325	Entropy too low (%c)		
326	RCI: File TX: %c	1	File sent
		2	File opened
327	RCI: File deleted: %c		
328	RCI File error: %c	1	Flash close error
		2	TX error
		3	RX error
		4	FLASH open error
329	RCI: File RX: %c	1	File received
		2	File opened
330	Wi-Fi assertion %c:%s		

Attachment List ID	Files
1	<input type="text"/>
2	<input type="text"/>
3	<input type="text"/>
4	<input type="text"/>

Event

This is not a configurable parameter; it is simply the event number, displayed for information only. This is the number to refer to when filtering events in the event log settings **Configuration > Alarms > Event Settings**.

Description

A description of the event code. Clicking on a link in this field brings up the configuration page associated with that event.

Filter

This parameter is for information only. If event filtering is applied to an event, the associated filter is shown as **On**. This is a result of enabling the parameter **Do not log this event** as described below.

Event Priority

Controls the priority of the event and determines whether an event will trigger email, SMS messages, or SNMP traps.

Reasons

The reason why the event occurred. Not every event has a list of reasons.

Reason Priority

This parameter is for information only.

Attachment List ID

A fixed list of values for conveniently referring to the associated list of files to attach to an email.

Files

Allows entering a comma-separated list of names for the files that should be attached to an email.

 **Command line**

Command	Instance	Parameter	Values	Equivalent web parameter
event	n	syslog_trig	ev_filter	Do not log this event

There are no commands for editing event logcodes. However, you can edit the **logcodes.txt** file which holds all the logcode information. For details on how to do this, see [View and manage the event log](#).

Configure event logcodes

Web

1. Go to **Configuration > Alarms > Event Logcodes**.
The **Event Logcodes** configuration page controls the configuration of the event that is displayed in bold font at the top of the page, just below the title bar.
2. Click on a particular link in the **Event Logcodes** page's **Event Description** column; for example, **Power-up[%c]**. The settings for the event are displayed.

Event Logcodes

Event: Power-up[%c]

Do not log this event

Log Priority:

Alarm Priority:

Alarm Priority is dependent on the event being logged by Entity All instance

Priority only applies to

PPP 0 PPP 1 PPP 2 PPP 3 PPP 4 PPP 5 PPP 6 PPP 7 PPP 8

PPP 9 PPP 10 PPP 11 PPP 12 PPP 13

PPP 14 PPP 15 PPP 16 PPP 17 PPP 18

PPP 19

Store a snapshot of the Traffic Analyser trace on the log drive

If this event creates an Email alarm

Attach a snapshot of the Traffic Analyser trace

After this event: Leave the Analyser trace
 Freeze the Analyser trace
 Delete the Analyser trace

Attach a snapshot of the Event Log

After this event: Leave the Event Log
 Delete the Event Log

Attachment List ID:

If this event creates a Syslog alarm, use

Syslog Priority:

Syslog Facility:

3. Enter the event logcode settings as needed:

Do not log this event

When enabled, this setting disables logging of the event. This parameter is **not** saved in the **logcodes.txt** file but in the **config.dan** file. This means that after changing this parameter, you must save the changes by clicking the save changes link when prompted (this appears after clicking the **Apply** button). If you click the **Save All Event Code Changes**, your changes are not reflected.

Log Priority

The priority of the event to determine whether the event will trigger emails, SMS messages or SNMP traps. **0**=disabled, **1**=highest priority, **9**=lowest priority.

Alarm Priority

If the above **Inherit alarm priority from event** setting is **not** enabled, this parameter selects the priority of the reason. Valid values are **0** to **9**.

Alarm Priority is dependent on the event being logged by Entity

Selecting this setting makes the priority conditional on which system entity triggered the event, such as Ethernet, and enables the following two configuration options:

Entity

A list of the system entities.

All

Selects all of the system entities.

Instance

Selecting this radio button enable a text entry box that allows the user to enter the instance of the selected entity.

Priority only applies to

A set of checkboxes, each checkbox controlling whether the priority is applied to that interface instance. So for example, to apply the priority to PPP interface **1**, click on **PPP 1** checkbox.

Store a snapshot of the Traffic Analyser trace on the log drive

Causes a snapshot of the analyser trace to be stored on the USB flash drive

If this event creates an Email alarm**Attach a snapshot of the Traffic Analyser trace**

Causes a snapshot of the analyser trace to be attached to the email.

After this event**Leave the Analyser trace**

Leaves the analyser trace unchanged.

Freeze the Analyser trace

Causes the analyser to be frozen, such as no more logging will take place until the email has been sent.

Delete the Analyser trace

Causes the analyser trace to be deleted once the email has been sent.

Attach a snapshot of the Event Log

Causes the event log to be attached to the email.

After this event**Leave the Event Log**

Leaves the event log unchanged.

Delete the Event Log

Deletes the event log after the email has been sent.

Attachment List ID

Lists the files to attach to the email. The ID refers to the table of files.

If this event creates a Syslog alarm, use Syslog Priority

The Syslog priority associated with this event, if it creates a Syslog alarm. This drop-down selection box contains the following options:

- Emergency
- Alert
- Critical
- Error
- Warning
- Info
- Debug

Syslog Facility

The Syslog facility associated with this event. This drop-down selection box contains the following options:

- Kernel
- User
- Mail
- System
- Auth
- Syslog

4. Click **Apply**.



Command line

There are CLI commands for editing event logcodes. However, you can edit the **logcodes.txt** file which holds all the logcode information. For details on how to do this, see [View and manage the event log](#).

Command	Instance	Parameter	Values	Equivalent web parameter
event	n	ev_filter	Comma-separated list of event codes	Do not log this event

Configure handling of the reasons for an event

Web

1. Go to **Configuration > Alarms > Event Logcodes**.
2. Select an event by clicking the links in the **Event LogcodesReasons** column; for example, the **Reboot command** for the **Power-up[%c]** event. This opens a page for configuring the reason.

Event Logcodes

Event: Power-up[%c] Reason:Reboot command

Log Priority:

Inherit alarm priority from event

Alarm Priority:

Alarm Priority is dependent on the event being logged by Entity All instance

Priority only applies to

PPP 0 PPP 1 PPP 2 PPP 3
 PPP 4 PPP 5 PPP 6 PPP 7 PPP 8
 PPP 9 PPP 10 PPP 11 PPP 12 PPP 13
 PPP 14 PPP 15 PPP 16 PPP 17 PPP 18
 PPP 19

Store a snapshot of the Traffic Analyser trace on the log drive

If this event creates an Email alarm

Attach a snapshot of the Traffic Analyser trace

After this event: Leave the Analyser trace
 Freeze the Analyser trace
 Delete the Analyser trace

Attach a snapshot of the Event Log

After this event: Leave the Event Log
 Delete the Event Log

Attachment List ID:

If this event creates a Syslog alarm, use

Syslog Priority:

Syslog Facility:

This page is similar to the **Event Logcodes** page for an event, but with the following difference: there is no **Do not log this event** checkbox. There is the following additional parameter:

Inherit alarm priority from event

Causes the following **Alarm Priority** parameter to be disabled, and causes the priority to be the same as the event that triggered it. The **Alarm Priority** parameter is the same as in the **Configuring Events** page.

3. Click **Apply**.

Command line

There are no commands for editing event logcodes. However, you can edit the **logcodes.txt** file which holds all the logcode information. For details on how to do this, see [View and manage the event log](#).

Command	Instance	Parameter	Values	Equivalent web parameter
event	n	ev_filter	Comma-separated list of event codes	Do not log this event

Configure an SMTP email account to send alarms

For the router to successfully send emails, an email account (SMTP) must be available.

Web

1. Go to **Configuration > Alarms > SMTP Account**. The **SMTP Account** page describes the configuration of the router to use the email account set up for it.

SMTP Account

Hostname or IP address of your SMTP Server: Port

Username:

Password:

Confirm password:

Display "Email From" as:

Attachment size limit:

If the email template does not contain one, use "Reply To" address:

Route using: Routing table
 Interface

Resend the email after seconds if the first attempt fails

2. Enter SMTP account parameters:

Hostname or IP address of your SMTP server

The IP address or hostname of the SMTP mail server, such as **smtp.myisp.com**. Sending email requires a connection to the Internet. Depending upon how the router is configured, it may be necessary to check that the PPP configuration allows a connection to the ISP or external SMTP mail server.

Port

The Simple Mail Transfer Protocol (SMTP) uses TCP port **25**, which is the default for this parameter. If the mail server uses a different TCP port, enter it here.

Username

Email accounts are controlled by requiring a username and password in order to send and receive mail. This field is where the account username is set. This information will be provided by the administrator of the email server.

Password

This field is where the account password is set.

Confirm password

Re-enter the password. The two passwords are compared to check that they are the same and that there hasn't been a typographical error when entering them. This check is deployed because password characters are not echoed. Therefore, the usual visual feedback is not available.

Display "Email From" as

The text for the **MAIL FROM** parameter, which forms part of the protocol when connecting to the email server. Most SMTP servers accept an empty string, while others require that this parameter is present. You may need to consult with the SMTP server administrator (or ISP) to determine whether this parameter is required.

Attachment size limit n Kbyte, Mbyte

Some email service providers place a limit on the size of an email attachment that they will accept, you can use this parameter to ensure that the limit is not exceeded. The traffic analyser and event logger can generate substantial files, and it may be required that these files are truncated when sent as email attachments. The size is specified in kilobytes. For example, setting this limit to **250** truncates the attachment to **250kB** before transmission. Setting the size to **0** means that no limits are imposed.

If the email template does not contain one, use "Reply To" address

This address is inserted into the email header if no reply address exists in the appropriate email template. If the email template does contain an address in the **reply to:** field, that will override the default reply address.

Route using Routing table, Interface x,y

When selected, the routing code determines the outbound interface, and that interface determines the source IP address. If the **Route using routing table** option is not selected, the settings in the interface and interface instance text boxes determine the outbound interface and source IP address. These are selected from the drop-down selection box and are **None**, **PPP**, and **Ethernet**.

Resend the email after s seconds if the first attempt fails

This setting and associated text entry box enable the retry mechanism. If the first attempt to deliver the email fails, the router waits the specified number of seconds (which must be non-zero) before making another attempt.

3. Click **Apply**.

 **Command line**

Command	Instance	Parameter	Values	Equivalent web parameter
smtp	n	server	Valid hostname or IP address	Hostname or IP address mailserver.isp.com 122.134.156.178

Command	Instance	Parameter	Values	Equivalent web parameter
smtp	n	port	Valid port number, such as as25	Port n
smtp	n	username	Free text field containing a valid account username such as my_account	Username
smtp	n	password	Free text field containing account password, such as my_password	Password
smtp	n	mail_from	Free text field	Display Email From as
smtp	n	att_lim	0-65535	Attachment size limit This CLI value is entered in Kilobytes only.
smtp	n	reply_to	Free text field	If the email template does not contain one, use Reply To address
smtp	n	userouting	0, 1	Route using routing table
smtp	n	ll_ent	Blank,PPP,ETH	Route using Interface x,y x=Interface type
smtp	n	ll_add	0-255	Route using Interface x,y y=interface number
smtp	n	retry_dly	0-255	Resend the email after s seconds if the first attempt fails

Configuring system settings

Set device identity parameters	707
Set system date and time	709
Set commands to run automatically at bootup	720
Set web and command line interface options	721
Set miscellaneous system options	724
Set power control options	726
Set temperature monitoring	730

Set device identity parameters

Web

1. Go to **Configuration > System > Device Identity**.

[Configuration - System > Device Identity](#)

▼ Device Identity

Description:

Contact:

Location:

Device ID:

Router Identity:

Hostname:

Secondary Hostname:

2. Enter device identity settings:

Description

A description of up to of up to **64** characters that uniquely identifies the router. This description is helpful when your site has many routers. A descriptive name can be an easier identifier than its serial number or other unique parameter. The SNMP function in the router uses this parameter.

Contact

A contact name for the router.

Location

A location string for the router, which again may be helpful when referring to a particular router within a site or for identifying a particular site.

Device ID

This field is taken from the Remote Manager configuration and should not normally need to be changed. When using Remote Manager to manage the router, the configuration procedure assigns a device ID to the router. The device ID is a 64-byte value, with each 8-byte section separated with a - character. Valid digits are upper case hexadecimal. The first 16 digits (reading from left to right) are normally set to **0**. The second 16 digits comprise the MAC address of the primary Ethernet interface and the digits **FF** to make up the full 8-digit. The following device ID illustrates the format, using the MAC address **00:11:22:33:44:55**:

```
00000000-00000000-001122FF-FF334455
```

Router Identity

A string of up to **20** characters that identify the router in email alert messages generated by the event logger. This string also serves as the prompt string during a remote login. The factory configuration uses the character sequence **%s**. This sequence is replaced by the serial number of the router when the unit identity is displayed. You can use this character sequence when creating a custom identity for the router. For example, if the serial number of the router is **012345**, entering the string **My_Router_%s>** would show the prompt **My_Router_012345>** during a remote login.

Hostname

Assigns a hostname of up to **64** characters to the local IP address of the router.

Secondary Hostname

Assigns a second hostname of up to **64** characters to a router. This is associated with the secondary IP address.

3. Click **Apply**.

Command line

Command	Instance	Parameter	Values	Equivalent web parameter
snmp	n	Name	Free text field up to 64 characters	Description
snmp	n	Contact	Free text field	Contact
snmp	n	Location	Free text field	Location
cmd	n	Unitid	Free text field	Router Identity
cmd	n	Hostname	Free text field up to 64 characters	Hostname
cmd	n	sec_hostname	Free text field up to 64 characters	Secondary Hostname

Set system date and time

The router keeps track of calendar time using an internal real time clock (RTC) device. The router uses this clock to time/date stamp logfiles. The router uses the 24-hour clock.

Because maintaining an accurate system clock can be important for routers on the Internet, you can configure the router use NTP and SNTP services to maintain the internal system time, in addition to setting the system date and time manually.

Using NTP is recommended for greater accuracy

NTP is much more accurate than SNTP, with an accuracy of 200 microseconds (1/5000 second) can be achieved. The NTP functionality is in accordance with RFC1305. You can configure up to 4 remote peers. All the peers are polled at intervals, and the best peer is selected for using as the time source. Configure SNTP before using NTP. The router calculates the accuracy of the NTP time servers over a period of time, up to 2 hours. Once the drift compensation is calculated, the router uses NTP client. The drift compensation value is stored in NVRAM and written to the **config.da0** file. If the router loses power or is rebooted, it does not need to re-calculate the accuracy of the NTP servers again. The compensation value is constantly monitored to make sure it remains correct.

Note Using SNTP achieves an accuracy of around **1** second. Using NTP achieves an accuracy of **200** microsecond. Not all models support NTP; this option only appears for models that do.

Set system date and time manually

Web

1. Go to **Configuration > System > Date and Time**.

Date and Time

Current system time: 31 May 2017 13:44:49

Manually set the time

Hours: Minutes: Seconds:

Month: Day: Year:

Timezone:

Update for Daylight Saving Time

Configure by indicating which day of the week in the month

Start: in at o'clock

End: in at o'clock

DST offset: minutes

2. Set date and time parameters:

Do not auto-set the system time

If enabled, allows you to set the system time manually. This is the system default, and this radio button is selected when the router is new, unless a different default configuration has

been supplied. Click this radio button to close the SNTP or NTP configuration pages. Enabling this setting displays the following fields:

Current system time

The current system time appears at the top of this web page.

Manually set the time *h* hours, *m* minutes *s* seconds, *M* month *D* day *Y* year

These parameters are set using the associated drop-down selection menus.

Hours

Select from the drop-down list to set the hours.

Minutes

Select from the drop-down list to set the minutes.

Seconds

Select from the drop-down list to set the seconds. This setting may have limited use due to human reaction times.

Month

Select from the drop-down list to set the month.

Day

Select from the drop-down list to set the day.

Year

Select from the drop-down list to set the year.

Set

Click this button to apply the settings.

Timezone

Sets the time to display in the local time for the selected time zone.

Update for Daylight Saving Time.

When checked, causes the following parameters to appear, the router uses those settings to automatically adjust the system time to ensure the router uses local Daylight Saving Time.

Start parameters

Month

The month in which to switch to daylight saving time.

Day

The day on which to switch to daylight saving time.

Hour

The hour at which to switch to daylight saving time.

End

Month

The desired month in which to switch back to GMT (UTC).

Day

The desired day on which to switch back to GMT.

Hour

The desired hour at which to switch back to GMT.

3. Click **Apply**.

Set system date and time automatically using an SNTP server

You can configure the router to have its system date and time set automatically by an SNTP server. SNTP continually polls an external NTP time server on either a private company network or the internet at a configured interval rate.

Web

1. Go to **Configuration > System > Date and Time > Autoselect Date and Time**.
2. Select **Use SNTP to auto-set the system time**. The SNTP server parameters appear:

Autoselect Date and Time

Do not auto-set the system time
 Use SNTP to auto-set the system time

SNTP Server:
 Authorisation key #:
 Authorisation key:
 Check on Power-Up

Update: every hours
 randomly between and seconds

Disable SNTP when interface: is out of service

Use NTP to auto-set the system time

3. Configure the SNTP server parameters:

SNTP server

The hostname or IP address of the desired SNTP server.

Authorisation key #

The SNTP authorization request key number. SNTP allows for authenticating SNTP requests and responses with a key. These SNTP requests include a key # field allowing the SNTP server can look up the appropriate key to use in performing the authorization.

Authorisation key

The key to associate with the configured authorization key number.

Check on Power-Up

When checked, causes the router to attempt to connect to the SNTP server every time it boots.

Update every h hours

The interval, in hours, the router should wait between updating the system clock.

Update randomly between s1 and s2 seconds

It is possible to use a random update interval rather than a fixed interval. There are two text-entry boxes for this purpose. Enter the minimum interval into the left-hand box, and the maximum desired interval into the right-hand box. Selecting the random update clears the fixed interval.

Offset from GMT

This parameter should be set to + or - the number of hours the router's time should be ahead or behind Greenwich Mean Time.

4. Click **Apply**.

Set system date and time automatically using an NTP server

You can configure the router to have its system date and time set automatically by an NTP server.

 **Web**

1. Go to **Configuration > System > Date and Time > Autoset Date and Time**.
2. Select **Use SNTP to auto-set the system time**. The NTP server parameters appear:

Configuration - System > Date and Time

Use NTP to auto-set the system time

Initial Drift Compensation: ppm

Clock Precision Limit: ▼

Disable NTP when interface: ▼ is out of service

You can configure NTP to use up to 4 servers. The more servers that are used, the more accurate the time setting will be.

NTP Server 1

NTP Server: Broadcast Mode

Authorisation key #:

Authorisation key:

Poll Interval: ▼ to ▼ seconds

Startup burst Interval: ▼ seconds

NTP Server 2

NTP Server: Broadcast Mode

Authorisation key #:

Authorisation key:

Poll Interval: ▼ to ▼ seconds

Startup burst Interval: ▼ seconds

NTP Server 3

NTP Server: Broadcast Mode

Authorisation key #:

Authorisation key:

Poll Interval: ▼ to ▼ seconds

Startup burst Interval: ▼ seconds

NTP Server 4

NTP Server: Broadcast Mode

Authorisation key #:

Authorisation key:

Poll Interval: ▼ to ▼ seconds

Startup burst Interval: ▼ seconds

3. Configure the NTP server parameters:

Initial Drift Compensation n ppm

NTP incorporates compensation for clock drift. If this parameter is known, it can be entered here. Otherwise, the router calculates this value over a period of time. Once calculated, the value is displayed in the text box.

Clock Precision Limit

Select the clock precision limit from the drop-down selection box.

Disable NTP when interface x,y is out of service

If the specified interface is out of service, the NTP is disabled until the interface is available again.

NTP Servers 1 - 4

The router can have up to four NTP server connections. The more NTP servers deployed, the more accurate the time setting will be. The following section describes the configuration of the connections.

NTP Server 1/2/3/4-Hostname

The NTP server hostname or IP address.

Authorisation key #

The NTP authorization request key number. NTP allows for authenticating NTP requests and responses with a key. These NTP requests include a key # field allowing the NTP server can look up the appropriate key to use in performing the authorization.

Authorisation key

The key to associate with the configured authorization key number.

Broadcast Mode

When enabled, the NTP client operates in a different manner. Rather than sending out an NTP client message and expecting a reply, the NTP module sends out a broadcast mode packet to the IP address configured in **NTP host** field. The broadcast interval is determined by the value of **Minimum poll interval**.

Poll Interval $s1$ to $s2$ seconds

The minimum and maximum intervals between poll broadcasts. The values are time, in seconds, represented as a power of 2. This means that a value of **4** means that the minimum poll interval is **$2^4=16$** seconds.

Startup burst Interval s seconds

When connecting to an NTP time server in polled mode, it may be necessary to send polls at intervals shorter than the minimum poll interval, to speed up the synchronization process. This parameter controls the interval between polls during the startup process. This feature is useful in situations where the router only has an intermittent Internet connection.

4. Click **Apply**.

Command line

Command	Instance	Parameter	Values	Equivalent web parameter
n/a	n/a	time	hh [mm [ss [DD [MM [YYYY]]]]]]	Manually set the time.
sntp	n	server	Valid hostname or IP address sntp.timeserve.org	SNTP Server
sntp	n	pwrchk	0, 1 0=Off 1=On	Check on Power-up
sntp	n	interval	0-255	Update every h hours Default= 24
sntp	n	randintsecs	0-86400	Randomly between s1 and s2 seconds Use format [s1,s2] For example, min 50 , max 500 would be: [50,500]
sntp	n	offset	-12 to +13	Offset from GMT.
sntp	n	dstonmon	0-12	Start: Month Update for Daylight Saving Time 0 disables daylight saving.
sntp	n	dstonday	0-31	Start: Day
sntp	n	dstonhr	0-23	Start: Hour
sntp	n	dstoffmon	0-12	End: Month
sntp	n	dstoffday	0-31	End: Day
sntp	n	dstoffhr	0-23	End: Hour
sntp	n	ntp	0, 1 0=SNTP 1=NTP Default=OFF	
ntp	n	driftppm	-10000-+10000	Initial Drift Compensation
ntp	n	precision	-10-0	Clock Precision Limit
ntp	n	inhibit_int	Blank, PPP, Ethernet	Disable NTP when interface x,y is out of service x=Interface type

Command	Instance	Parameter	Values	Equivalent web parameter
ntp	n	inhibit_add	0-255	Disable NTP when interface x,y is out of service y=interface number
ntp	n	server	Valid IP address or hostname, such as ntp1@timeserver.org	NTP Server
ntp	n	bcast	0, 1	Broadcast Mode 0=disabled 1=enabled
ntp	n	minpoll	3-14	Poll Interval s1, s2 3=8 4=16 5=32 6=64 7=128 8=256 9=512 10=1024 11=2048 12=4096 13=8192 14=16384
ntp	n	maxpoll	3-14	Poll Interval s1, s2 See minpoll parameter for values.
ntp	n	burstint	0-255	Startup burst Interval s seconds
ntp	n	server2	Valid IP address or hostname, such as ntp2@timeserver.org	NTP Server
ntp	n	bcast2	0, 1 0=disabled 1=enabled	Broadcast Mode
ntp	n	minpoll2	3-14	Poll Interval s1, s2 See minpoll parameter for values.
ntp	n	maxpoll2	3-14	Poll Interval s1, s2 See minpoll parameter for values.
ntp	n	burstint2	0-255	Startup burst Interval s seconds
ntp	n	server3	Valid IP address or hostname, such as ntp3.timeserver.org	NTP Server.

Command	Instance	Parameter	Values	Equivalent web parameter
ntp	n	bcast3	0, 1 0=disabled 1=enabled	Broadcast Mode
ntp	n	minpoll	3-14	Poll Interval s1, s2 See minpoll parameter for values.
ntp	n	maxpoll	3-14	Poll Interval s1, s2 See minpoll parameter for values.
ntp	n	burstint3	0-255	Startup burst Interval s seconds
ntp	n	server4	Valid IP address or hostname, such as ntp4.timeserver.org	NTP Server.
ntp	n	bcast4	0, 1 0=disabled 1=enabled	Broadcast Mode
ntp	n	minpoll4	3-14	Poll Interval s1, s2 See minpoll parameter for values.
ntp	n	maxpoll4	3-14	Poll Interval s1, s2 See minpoll parameter for values.
ntp	n	burstint4	0-255	Startup burst Interval s seconds

ntpstat command: Check NTP client status

To check the status of the NTP client, use the **ntpstat** command. See the **Command line** section of [Show NTP status](#).

Set commands to run automatically at bootup

The router can be configured to run a number of commands once it has booted. These commands are associated with specific asynchronous serial interfaces. For example, suppose a Script Basic script, **sample.bas**, must be run at boot up. Autorun commands are normally associated with an ASY port, but running a script for example is not ASY port-specific.

Web

1. Go to **Configuration > System General > Autorun Commands**.

Autorun Commands

You can configure some commands that will automatically run when the unit has booted up.
(You may specify up to 11 commands)

Command	Delete
ats31=7	Delete
	Add

2. In the **Command** field, enter the CLI command to run at bootup. For example, to run the Script Basic script **sample.bas** at bootup, you would enter **bas sample.bas**.
3. Click **Add**.
4. Click **Apply**.

Command line

Command	Instance	Parameter	Values	Equivalent web parameter
cmd	n	autocmd	Valid CLI command	Autorun Commands

Set web and command line interface options

Web

1. Go to **Configuration > System > General > Web / Command Line Interface**.

Web / Command Line Interface

Automatically log user out if idle for hrs mins secs

For users connected on a serial port
 Use access level: ▼
 Automatically log user out: Never
 If idle for hrs mins secs

Disable Remote command echo for Telnet sessions

CLI Pre-Login Banner: ▼

CLI Post-Login Banner: ▼

Allow CLI access from X.25 address:

With TRANSIP, use access level: ▼

Default WEB page:

Display runtime info on the login WEB page

TACACS+ authorises WEB requests on a page by page basis

2. Set web and command line options as needed:

Automatically log user out if idle for h hours m minutes s seconds

To limit the probability of unauthorized users gaining access to the router, login timeouts are applied. These timeouts cause an existing connection to be closed after a predefined period. The default is **20** minutes.

For users connected on the local Async port Use access level None, Low, Med, High, Super

For security purposes, logging into the router is controlled by a user access level. This parameter controls the access level that applies when logging in via the local asynchronous serial port.

Automatically log user out Never / If idle for h hrs m mins s secs

How long the local port allows access before terminating the connection and requiring the user to log in again. Selecting the **Never** buttons allows permanent access to the router via the local asynchronous serial port. If, for security reasons, it is required that the access should be limited, the appropriate time period can be entered into the text entry boxes.

Disable Remote command echo for Telnet sessions

Enables/disables command echo for remote access. This applies to Telnet and TRANSIP sessions.

CLI Pre-Login Banner

The router can display a banner before any login information is requested. The parameter specifies the name of a file that is stored in the flash filing system and contains the text to be displayed before the request for the username and password. This can be useful for displaying a standard welcome message or any site-specific user instructions.

CLI Post-Login Banner

Once the user has successfully logged on to the router, a second message can be displayed. This parameter specifies the name of a file containing the text to display. As above, the file may contain site-specific instructions to be carried out once the user has logged in.

Allow CLI access from X.25 address n

Enables/disables logging into the router over an X.25 connection. The parameter **n** must be a valid X.25 NUA (Network User Address).

With TRANSIP, use access level None, Low, Med, High, Super

Controls the security access level when using TRANSIP to access the router.

Default WEB page

Sets the default web interface page to open for the router. The default is **default.asp**.

Display runtime info on the login WEB page

Shows or hides runtime status information about the device on the login page.

TACACS+ authorises WEB requests on a page by page basis

If enabled, each request for a page results in a TACACS+ authorisation request getting sent off to the TACACS server. The request will include the name of the requested page. If this setting is disabled and you are using TACACS for authorization, a TACACS authorisation request is only sent to the server when the user first logs in.

3. Click **Apply**.

 **Command line**

Command	Instance	Parameter	Values	Equivalent web parameter
cmd	n	tremto	0-86400 seconds	Automatically log user out if idle for h hrs m mins s seconds This CLI value is entered in seconds only.

Command	Instance	Parameter	Values	Equivalent web parameter
local	n	access	0-4	Use access level 0=Super 1=High 2=Medium 3=Low 4=None 8=Read only
local	n	tlcto	Free text field	Never, h hrs, m mins, s secs
cmd	n	noremecho	0, 1 0=Off (default) 1=On	Enable Remote command echo
cmd	n	prebanner	Valid filename such as welcome1.txt	CLI Pre-Login Banner
cmd	n	postbanner	Valid filename such as welcome2.txt	CLI Post-Login Banner
cmd	n	cmdnua	0-1023	Allow CLI access from X.25 address
local	n	transaccess	0-4	With TRANSIP, use access level 0=Super 1=High 2=Medium 3=Low 4=None 8=Read only
web	0	prelogin_info	on, off Default value: off	Display runtime info on the login WEB page
web	0	tacacspageauth	on, off Default value: on	TACACs+ authorises WEB requests on a page by page basis

Set miscellaneous system options

Web

1. Go to **Configuration > System > General**.

Depending on the router model, this page may have several miscellaneous system options in the **Miscellaneous** section; for example:

Miscellaneous

Use Config when the router powers up

Allow anonymous FTP login

Additional FTP NAT port:

SNMP Enterprise Number:

SNMP Enterprise Name:

Only resolve DNS requests for domain:

Serial LED to display: status

2. Set miscellaneous options as needed:

Use Config n when the router powers up

The router maintains two configuration files, either of which may be invoked on power-up. Select the required one from the drop-down selection box. Use this option with care as selecting the incorrect configuration file can cause confusion.

Allow anonymous FTP login

Enables or disables the router to accept anonymous logins. The default state is Off and the security implications of enabling this option should be considered carefully before applying.

Additional FTP NAT port n

Standard FTP uses two well-known ports, a control port and data port. These are low-number ports, and can be blocked by firewall rules. As such, it may be that an FTP server may be listening on a non-standard control port. This parameter sets the port the router should monitor for FTP **PORT** and **PASV** commands. These commands contain information relating to IP addresses and ports that should be modified during the NAT process. The NAT modifications can result in different-sized packets being generated that then require that the TCP sequence numbers be modified to allow for the changes.

SNMP Enterprise number

The value of the OID (Object Identifier) SNMP management tools to use when accessing the MIB (Management Information Block). This number must form part of the OID for accessing individual items in the MIB as a prefix. For example: **SNMPv2-SMI::enterprises.16378.10001**.

SNMP Enterprise Name

The name corresponding to the above Enterprise Number.

Only resolve DNS request for domain

Entering a domain name here restricts DNS requests to the specified domain only.

W-WAN LED to display W-WAN, ISDN/PSTN

On the front panel of the display of models fitted with a W-WAN module, is an LED that you can use to display the status of the W-WAN module or the status of the PSTN/ISDN connection. Use the drop-down selection box to choose what the LED displays. The ISDN/PSTN settings depend upon which of these two options are available on the router.

Serial LED to display Connection, DTR

On the front panel of the router is an LED dedicated to indicating the status of various signals on the asynchronous serial line. Use the drop-down selection box to choose which signal status to display. On modules fitted with W-WAN, this LED has additional functionality, you can use this LED to display the W-WAN signal strength.

3. Click **Apply**.

 **Command line**

Command	Instance	Parameter	Values	Equivalent web parameter
config	n	powerup	0, 1	Use Config n when the router powers up
cmd	n	anonftp	0, 1 0=Off (default) 1=On	Allow anonymous FTP login
snmp	n	ftpnatport	0-65535	Additional FTP NAT port
snmp	n	ent_nb	0-65535	SNMP Enterprise Number Default 16378
cmd	n	ent_name	Free text field	SNMP Enterprise Name
cmd	n	dnsname	Valid Domain name, such as mydomain.org	Only resolve DNS request for domain
cmd	n	gprsled_mode	0, 1	W-WAN LED to display W-WAN, ISDN/PSTN 0=W-WAN 1=ISDN/PSTN
cmd	n	asyled_mode	0, 1	Serial LED to display Connection, DTR 0=Connection 1=DTR status 2=W-WAN signal strength

Set power control options

You can reduce the amount of power a Digi TransPort router consumes.

- In normal operation, TransPort WR21 and WR31 models consume around **300 mA** from a **12 V** DC power supply, which equates to about **4 W**.
- The TransPort WR41v2 consumes around **400 mA** from a **12 V** DC power supply which equates to about **4.8 W**.
- The TransPort WR44v2 consumes around **800 mA** from a **12 V** DC supply, which equates to about **10 W**.

Reducing power consumption is useful for remote sites with no mains supply available, solar or wind battery-powered applications, when the router is communicating with a serial device only, or when you want to wake the router at a certain time by using a Python script to turn on the cellular module and send data. The tradeoff for reducing power consumption is reduced functionality and/or reduced performance. For example, with the most aggressive power reductions available on the TransPort WR21, you can reduce the power consumption to under **1 W**.

Functional areas for saving power

There are several areas of TransPort router functionality where you can save power, if necessary:

- Lower the CPU speed. TransPort WR21 and WR31 models have two CPU settings available:
 - **0** = high speed (454 MHz)
 - **1** = low speed (360 MHz)

TransPort WR41 & WR41v2 models have three CPU settings available:

- **0** = high speed (400 MHz)
- **1** = medium speed (266 MHz)
- **2** = low speed (133 MHz)
- Turn off the LEDs on the front panel of the router.
- Disable Ethernet capability.
- Disable cellular module functionality.
- Disable GPS functionality, where fitted.
- Disable GPRS functionality, where fitted.
- Disable Wi-Fi, where fitted.
- Disable DSL functionality, where fitted.
- Disable the USB port.

Power control profiles

The router has several groups of power control settings, referred to as power control profiles, numbered from **0** to **3**. At startup, the router always uses power control profile **0** unless otherwise configured.

You can change the power control profile from the command line only.

Additional information on power control

For more information, see [Application Note 67: Using The Low Power Modes on TransPort](#).

Web

1. Go to **Configuration > System > Power Control**. The currently selected power control profile is shown in the Current profile field. By default, **Profile 0** is selected. Each power control profile has these settings:

CPU speed

Sets the CPU speed for the router. You can set this value to **High** for high speed, and **Low** for low speed.

LEDs

Enables or disables the illumination of front-panel LEDs.

Mobile Module

Enables or disables the cellular module.

GPS

Enables or disables GPS functionality .

GPRS

Enables or disables GPRS functionality .

Ethernet

Enables or disables Ethernet capability.

Wi-Fi

Enables or disables Wi-Fi functionality.

DSL

Enables or disables DSL functionality.

USB

Enables or disables the USB port.

2. Click **Apply**.

 **Command line**

Command	Instance	Parameter	Values	Equivalent web parameter
pwrctrl	0-3	cpuspeed	0-3 Available speed values vary by model 0 = high speed (454 MHz) 1 = low speed (360 MHz) 2 3	CPU Speed
pwrctrl	0-3	leds	on, off	LEDs
pwrctrl	0-3	eth	on, off	Ethernet
pwrctrl	0-3	gprs	on, off	Mobile Module
pwrctrl	0-3	gps	on, off	GPS
pwrctrl	0-3	wifi	on, off	Wi-Fi
pwrctrl	0-3	dsl	on, off	DSL
pwrctrl	0-3	act_rq	The power control profile number. You can enter this command immediately after setting the parameters and is useful when testing the functionality. You must save the profile by entering config 0 save .	None - Power control profile is selected through command line only.
pwrctrl	none	status	Displays the current active power control configuration	The Power Control display for the currently selected power control profile.

Example

To set setting a router's CPU to low-speed and all other power control parameters to **off**, enter:

```
pwrctrl 1 cpuspeed 1
OK
pwrctrl 1 leds off
OK
pwrctrl 1 eth off
OK
pwrctrl 1 gprs off
OK
pwrctrl 1 gps off
OK
pwrctrl 1 ?
Parameters are..
    cpuspeed: 1
    leds: OFF
```

eth: OFF
gprs: OFF
gps: OFF

OK

Set temperature monitoring

You can monitor the temperature of some of the components on the TransPort router in real time. The temperature is monitored through the Digi Remote Manager health metrics. You can configure the router to power off device subsystems when various components exceed a temperature limit. For more information, see [Quick Note 46: Temperature Monitoring on Digi TransPort Routers](#)

Web

1. Enable health metrics to display in the Digi Remote Manager health monitor. See [Enable device health reporting](#).
2. Go to **Configuration > System > Temperature Monitoring**. Configure these settings:

Power off subsystems when motherboard above operating temperature limit

Displayed for Digi TransPort model WR44v2 only. Enables automatic shutdown of various subsystems when the mainboard temperature sensor indicates that the motherboard is operating above its normal temperature range.

Power off modem RF when module above operating temperature limit

Enables automatic shutdown of the cellular modem's RF interface when the cellular modem's temperature sensor indicates that the modem is operating above its normal temperature range.

3. Click **Apply**.

Command line

Command	Instance	Parameter	Values	Equivalent web parameter
templog	0	mb_autooff (Digi TransPort model WR44v2 only)	on, off	Power off subsystems when motherboard above operating temperature limit
templog	0	mo_autooff	on, off	Power off modem RF when module above operating temperature limit

Configuring remote management

Use Digi Remote Manager to manage devices	732
Use SNMP for remote management	742

Use Digi Remote Manager to manage devices

Digi Remote Manager is a hosted remote configuration and management system for managing a large number of routers.

Digi Remote Manager provide a web-based interface that shows the configuration of selected routers allows the configuration to be changed and also facilitates remote firmware upgrade. The Digi Remote Manager servers also provide a data storage facility.

Using Digi Remote Manager requires setting up a Digi Remote Manager account. Applying for an account is a straightforward procedure; the local sales representative will have details. To set up a Digi Remote Manager account and learn more about Digi Remote Manager, go to <http://www.digi.com/products/cloud/digi-remote-manager>.

Configure Digi Remote Manager

Web

1. Go to **Configuration > Remote Management**.
2. Set the following values:

Enable Remote Management using a client-initiated connection

Displays the basic configuration parameters and enables the router to make the connection to the Remote Manager server.

Server Address

The IP address or (more usually) the domain name of the Remote Manager host. This information will be supplied when your Remote Manager account is activated.

Automatically reconnect to the server after being disconnected

The protocol for communicating with the server allows the router to detect that it is no longer connected to the server. Enabling this setting causes the router to attempt to reconnect when it discovers the connection has been lost.

Reconnect after h hours m minutes s seconds

The interval to wait before attempting to reconnect to the server.

Password/Confirm password

The authentication password for connecting to the server.

Use SSL

Enables or disables use of SSL on the remote management connection.

3. Click **Apply**.

Command line

Command	Instance	Parameter	Values	Equivalent web parameter
cloud	0	clientconn	0, 1	Enable Remote Management and Configuration using a client-initiated connection 0=Off 1=On
cloud	0	server	Valid IP address such as 1.2.3.4 or domain name such as login.remotemanager.digi.com	DNS Resolve Server Address only when a default route is UP

Command	Instance	Parameter	Values	Equivalent web parameter
cloud	0	reconnect	0, 1	Automatically reconnect the server after being disconnected 0=Off 1=On
cloud	0	reconnsecs	0-86400	Reconnect after h, m, s This CLI value is entered in seconds only.
cloud	0	pwd	password string	Password
cloud	0	epwd	password string	Confirm Password
cloud	0	ssl	on, off	Use SSL

Configure using SMS messages for remote management

The SMS feature supports sending and receiving SMS messages between Remote Manager and a Remote Manager-registered router. You can use SMS to:

- Send an SMS message to the router in order to have the router dynamically establish its EDP connection with Remote Manager
- Send user defined data to and from Remote Manager and Remote Manager-registered router
- Perform limited device management such as pinging the router, as well as provisioning it properly for SMS functionality with Remote Manager

For more information on the SMS feature, see the [Digi Remote Manager User Guide](#).

Web

1. Go to **Configuration > Remote Management > Remote Manager > SMS Settings**.
2. Set the following values:

Enable Remote Manager SMS

Check this box to enable Remote Manager SMS feature

Enable Opt-in

Enable the opt-in to ensure that you have subscribed to the SMS service. Check this box to enable opt-in.

Enable Strict Sender

You can enable the Strict Sender mode to ensure that the SMS messages from Remote Manager are never blocked. Check this box to enable the Strict Sender framework.

Enable responses to be sent to the sender's phone number

Check this box to enable responses to be sent to the sender's phone number.

Accept Remote Manager client connection requests

Enable client connection requests to accept the incoming connections. Check this box to enable Remote Manager client connection requests.

Accept requests to connect to other Remote Manager servers

Check this box to accept request to connect to other Remote Manager servers.

Override the destination phone number with the following number

Check this box to override the destination phone number with another phone number. Once you check this box, the phone number text box is enabled. You can enter the phone number in this text box.

Override the service ID with the following value

Check this box to specify the service ID value. Once you check this box, the service ID text box is enabled. You can enter your service ID in this text box.

Limit CLI response to

You can specify the maximum CLI response size in this text box.

3. Click **Apply**.

**Command line**

Command	Instance	Parameter	Values	Equivalent web parameter
cloudsms	0	enable	off, on Default: off	Enable Remote Manager SMS
cloudsms	0	optinenable	off, on Default: off	Enable Opt-in
cloudsms	0	strictsender	off, on Default: off	Enable Strict Sender
cloudsms	0	replytosender	off, on Default: off	Enable responses to be sent to the sender's phone number
cloudsms	0	pagedconnect	off, on Default: off	Accept Remote Manager client connection requests
cloudsms	0	connectoverride	off, on Default: off	Accept requests to connect to other Remote Manager servers
cloudsms	0	phnum	Number	Override the destination phone number with the following number
cloudsms	0	svcid	Number	Override the service ID with the following value
cloudsms	0	maxcliresp	Number Default: 0	Limit CLI responses to n bytes.
cloudsms	0	debug	off, on Default: off	None

Enable device health reporting

You can enable the gathering of health metrics information for your device to display on the Digi Remote Manager Device Health chart. For more information on the Device Health chart and health status reports, see the [Digi Remote Manager User Guide](#).

You can set how often you want health metrics samples reported to Digi Remote Manager, and which type of health metrics to report: Ethernet metrics, mobile/cellular metrics, and system metrics.

Web

1. Before enabling health reporting for the router, make sure the router is registered and set to connect with Digi Remote Manager. For instructions, see [Configure Digi Remote Manager](#).
2. Go to **Configuration > Remote Management > Remote Manager > Health Metrics**.
3. Set the following values:

Report samples to Remote Manager every n minutes

How often, in minutes, the router reports health metrics to Digi Remote Manager. The default is **60** minutes.

Enable Ethernet metrics

Enables reporting of Ethernet metrics to Digi Remote Manager.

Sample Ethernet metrics every n minutes

How often, in minutes, the router reports Ethernet health metrics to Digi Remote Manager. The default is **60** minutes.

Enable Mobile Metrics

Enables reporting of mobile metrics to Digi Remote Manager.

Sample Mobile metrics every n minutes

How often, in minutes, the router reports mobile health metrics to Digi Remote Manager. The default is **60** minutes.

Enable System Metrics

Enables reporting of system metrics to Digi Remote Manager.

Sample System metrics every n minutes

How often, in minutes, the router reports system health metrics to Digi Remote Manager. The default is **60** minutes.

4. Click **Apply**.

**Command line**

Command	Instance	Parameter	Values	Equivalent web parameter
metrics	0	report_rate	integer Default is 60 .	Report samples to Remote Manager every n minutes
metrics	0	eth_metrics	on, off	Enable Ethernet metrics
metrics	0	eth_sample_rate	integer Default is 60 .	Sample Ethernet metrics every n minutes
metrics	0	mobile_metrics	off, on	Enable Mobile Metrics
metrics	0	mobile_sample_rate	integer Default is 60 .	Sample Mobile metrics every n minutes
metrics	0	sys_metrics	on, off	Enable System Metrics
metrics	0	sys_sample_rate	integer Default is 60 .	Sample System metrics every n minutes
metrics	0	debug	on, off	None. Enables debug mode for health metrics reporting.

Configure advanced remote management settings

The main group of Remote Manager settings, along with the system defaults, are sufficient to establish a connection to the Remote Manager server. The settings in the **Advanced** section allow you to fine-tune the Remote Manager connection.

Advanced remote management settings control detecting loss of connection. When the router first connects to the Remote Manager server, the link parameters are sent to it. The WAN settings and Ethernet settings described below are identical, but it should be noted in the command line descriptions, the default keepalive intervals are different. This is owing to the different characteristics of PPP and Ethernet links.

Web

1. Go to **Configuration > Remote Management > Remote Manager > Advanced**.
2. Configure the **Connection Settings**, as needed.

Connect using a proxy

The router connects using HTTP over proxy.

Proxy Port

When **Connect using a proxy is selected**, this value is the proxy host port.

Proxy URL

When **Connect using a proxy is selected**, this value is the URL of the proxy server to which the router connects.

Disconnect when Remote Manager is idle

Once the router has connected to the Remote Manager server, and the server has established that all the settings it holds for the router are current, and no new changes are being requested, the traffic between the router and Remote Manager server reduces to the sending of keep-alive packets. In this situation, it may be advantageous to terminate the connection to reduce bandwidth or to keep data costs down. Enabling this setting causes the router to negotiate termination of the connection.

Idle Timeout h hours, m minutes, s seconds

The timeout entered here defines how long the router should wait after detecting the idle condition before negotiating termination of the link. Default is **10** seconds.

Data Service Token / Confirm data service token

3. Configure the **WAN Settings**, as needed.

Receive Interval s seconds

The time between keep-alive packets that the router should wait before considering that the connection may be lost.

Transmit Interval s seconds

The interval between transmission of keep-alive packets.

Assume connection is lost after n timeouts

Occasional packet loss is to be expected. This parameter allows for a specified number of lost keep-alive packets before the connection is deemed to have failed.

4. Configure the **Ethernet Settings**, as needed.

Receive Interval s seconds

The time between keep-alive packets that the router should wait before considering that the connection may be lost.

Transmit Interval s seconds

The interval between transmission of keep-alive packets.

Assume connection is lost after n timeouts

Occasional packet loss is to be expected. This parameter allows for a specified number of lost keep-alive packets before the connection is deemed to have failed.

5. Click **Apply**.

**Command line****cloud command**

Command	Instance	Parameter	Values	Equivalent web parameter
cloud	0	use_proxy	on, off	Connect using a proxy
cloud	0	proxy_port	port number	Proxy Port
cloud	0	proxy_url	URL string	Proxy URL
cloud	0	idledisconn	0, 1	Disconnect when Remote Manager server is idle 0=Do not disconnect 1=Disconnect
cloud	0	disconnsecs	0-28800	Idle Timeout h,m,s This CLI value is entered in seconds only.
cloud	0	ppprxkeepalive	0-28800	WAN - Receive Interval seconds.
cloud	0	ppptxkeepalive	0-28800	WAN - Transmit Interval seconds.
cloud	0	pppwaitfor	1-255	WAN - Assume connection is lost after n timeouts.
cloud	0	ethrxkeepalive	0-28800	Ethernet - Receive Interval seconds.
cloud	0	ethtxkeepalive	0-28800	Ethernet - Transmit Interval seconds.
cloud	0	ethwaitfor	1-255	Ethernet - Assume connection is lost after n timeouts.

cloudstat command: Show status of socket connections

To show the status of the socket connections including whether there is a live connection to the Remote Manager server, enter the **cloudstat** without parameters. For example:

```
cloudstat
```

```
Connection Status: Not Connected
Server:            my.devicecloud.com
Current Server:
Client:            0
Auto-reconnect:   1
Reconnect:        0
Connect attempts: 0
Socket ID:        -1
Conn State:       Disabled
Uptime (secs):    0
Total Bytes RX:   0
Total Bytes TX:   0
```

```
OK
```

Use SNMP for remote management

Simple Network Management Protocol (SNMP) is a protocol for remotely managing and monitoring network devices. Network administrators can use the SNMP architecture to manage nodes, including servers, workstations, routers, switches, hubs, and other equipment on an IP network, manage network performance, find and solve network problems, and plan for network growth.

Supported SNMP versions

The Simple Network Management Protocol (SNMP) is a well-established way of managing clusters of remote routers. TransPort devices support the SNMP versions **SNMPv1**, **SNMPv2c**, and **SNMPv3**.

Supported Management Information Bases (MIBs)

The standard Management Information Bases (MIBs) supported by the router are:

- SNMP MIB (RFC3418)
- Interfaces MIB (RFC2233)*
- IP MIB (RFC2011)
- IP Forwarding Table MIB (RFC2096)
- TCP MIB (RFC2012)
- UDP MIB (RFC2013)
- VRRP MIB (RFC2787)
- SNMP MPD MIB (RFC3412)
- SNMP USM MIB (RFC3414)**

* The following groups/tables in RFC2233 are not supported: **ifXTable**, **ifStackTable**, **ifRcvAddressTable**.

** The following groups/tables in RFC3414 are not supported: **usmUserTable**.

Other MIBs may be available on request.

Besides the above MIBs, there are two other MIBs that are supplied as standard:

- There is a MIB that is generated after the firmware has been installed. This is accomplished using the **mibprint** CLI command and the **MIBEXE** DOS tool, available from Digi Technical Support. This MIB changes with every firmware release, since the firmware revision is embedded in the Object Identifiers (OIDs). This MIB provides access to most of the configuration and statistics that are associated with the router.
- The second MIB is the **Monitor** MIB, a standard MIB that gives access to various Digi TransPort proprietary objects. The OIDs in this MIB do not change with every release, although it is possible for new objects to be added to it. This MIB is available from Digi Technical Support.

at\smib commands

The **at\smib** command allows you to view a single standard MIB variable. See [at\smib commands](#) for a description of the **at\smib** command variants.

Configure SNMP settings

Web

1. Go to **Configuration > Remote Management > SNMP**.
2. Configure the **SNMP** settings, as needed.

Enable SNMPv1

Enables/disables support for version 1 of the protocol.

Enable SNMPv2c

Enables/disables support for version 2c of the protocol.

Enable SNMPv3

Enables/disables support for version 3 of the protocol.

Use TACACS+ if enabled for authorisation

If enabled, the router uses TACACS to authenticate user requests, if TACACS+ is properly configured. See [Use TACACS+ to control access to the router](#).

Use UDP Port n

The UDP port number to use. The default is UDP port **161**.

SNMPv3 Engine ID

Required as part of the SNMP v3 protocol. This is a **24**-hexadecimal character string; any trailing zeros in this string making the value up to **24** characters can be omitted. A remote engine ID is required when a SNMP v3 Inform is configured. The router uses the remote engine ID to compute the security digest for authenticating and encrypting packets sent to a user on the remote host.

3. Click **Apply**.

Command line

Command	Instance	Parameter	Values	Equivalent web parameter
snmp	0	v1enable	on, off	Enable SNMPv1
snmp	0	v2cenable	on, off	Enable SNMPv2c
snmp	0	v3enable	on, off	Enable SNMPv3
snmp	0	engineid	String	SNMPv3 Engine ID
snmp	0	port	0-65535	Use UDP Port Default= 161
snmp	0	tacacs_auth	on, off	Use TACACS+ if enabled for authorisation

Configure SNMP users

TransPort routers support up to **10** SNMP users.

Web

1. Go to **Configuration > Remote Management > SNMP > SNMP Users**.
2. Depending on the SNMP version you have chosen for remote management, configure the **SNMP Users** settings for each SNMP user, as needed.

▼ **SNMP Users**
 ▼ **SNMP User 0**
 SNMPv1 /
 SNMPv2c
 Community:
 Confirm
 Community:
 Access: **Read Only** ▼

SNMPv3
 Username:
 Authentication: None MD5 SHA1 SHA256
 Authentication
 Password:
 Confirm
 Authentication
 Password:
 Encryption: None DES AES
 Encryption
 Password:
 Confirm Encryption
 Password:

 ▶ **SNMP User 1**
 ▶ **SNMP User 2**
 ▶ **SNMP User 3**
 ▶ **SNMP User 4**
 ▶ **SNMP User 5**
 ▶ **SNMP User 6**
 ▶ **SNMP User 7**
 ▶ **SNMP User 8**
 ▶ **SNMP User 9**

SNMPv1 / SNMPv2c settings

Community

The community string for Version 1 and Version 2c SNMP packets.

Confirm Community

The community string is echoed as dots in the text entry box. Having a second confirmation field where the string is retyped allows a simple check to be performed for correct entry.

Access

The SNMPv1 or SNMPv2c community name.

SNMPv3 settings**Username**

The name of the SNMP user.

Authentication None, MD5, SHA1, SHA256

Select the authentication algorithm to apply to SNMP transactions.

Authentication Password

The authentication password for the user.

Confirm Authentication Password

The authentication password is not shown as clear text. The confirmation box allows a simple check that the password has been entered correctly.

Encryption None, DES, AES

These three radio buttons select which encryption (privacy) algorithm should be applied to the SNMP data.

Encryption Password

Enter the user's password for controlling privacy of the SNMP transactions into this text box.

Confirm Encryption Password

The encryption password is not shown as clear text. The confirmation box allows a simple check that the password was entered correctly.

3. Click **Apply**.

**Command line**

Command	Instance	Parameter	Values	Equivalent web parameter
snmpuser	n	community	public / private	Community
snmpuser	n	name	user_name	Username
snmpuser	n	auth	Off,MD5,SHA1	Authentication, None, MD5, SHA1
snmpuser	n	authPassword	my_password	Authentication Password
snmpuser	n	priv	Off,DES,AES	Encryption, None, DES, AES
snmpuser	n	privPassword	my_password	Encryption Password

Configure SNMP filters

SNMP filters allow the system administrator to control access to the router MIBs via SNMP. You can configure up to **10** SNMP filters.

Web

1. Go to **Configuration > Remote Management > SNMP Filters**.
2. Enter the SNMP filters in the table on this page. This table has three columns, two main headed columns, described below, and a control column of buttons. You can configure up to **10** SNMP filters, ranging from **0** to **9**.

SNMP Filters

SNMP filters allow you to block access to specific OIDs for particular users.
 Partial OIDs can be entered (e.g. 1.3.6.1.2.1 would match all OIDs beginning with these values.)
 (you may specify up to 10 filters)

Username	OID Prefix	
No filters have been configured		
<input type="text"/>	<input type="text"/>	<input type="button" value="Add"/>

Username

The username of the user to whom the access restriction is applied, as configured in the **Configuration > Security > Users** section.

OID Prefix

The Object ID (OID) prefix for the range of objects in the MIB that the user is not allowed to view. such as **1.3.6.1.2.1.4**.

Add

Adds the username and OID prefix into the table.

Delete

Deletes the associated entry in the table.

3. Click **Apply**.

Command line

Entity	Instance	Parameter	Values	Equivalent web parameter
snmpfilter	n	user	username	Username
snmpfilter	n	oid	Valid SNMP OID	OID Prefix

Configure SNMP traps

The router firmware supports the use of SNMP, with the ability to generate traps. To make the SNMP (Simple Network Management Protocols) functional, you must configure a SNMP trap server.

Web

1. Go to **Configuration > Remote Management > SNMP > SNMP Traps**.
2. Specify which types of SNMP traps you want to generate:

Generate Enterprise traps

Enables or disables generation of enterprise traps.

Generate Generic traps

Enables or disables generation of generic traps.

Generate Authentication Failure traps

Enables or disables generation of authentication failure traps.

Generate VRRP traps

Enables or disables generation of VRRP traps.

3. In **SNMP Trap Server 0**, configure the settings for SNMP trap server **0**:

Trap Server IP Address

The IP address for the SNMP trap server.

Port

The network port number for the SNMP trap server.

Use interface *interface-type interface-number* for the source IP address

The interface type and number to use for the source IP address. interface-type can be **Auto**, **PPP**, or **Ethernet**.

Use SNMP Version

The SNMP version to use (SNMPv1, SNMPv2c, or SNMPv3).

Send "Inform Request" message

Enables or disables sending the trap as an Inform Request message, which requires an acknowledgment from the recipient. If this setting is enabled, these settings are displayed:

If no response, retransmit the Inform Request message after n seconds

Sets the Inform Request to retransmit if there is no response from the recipient after the specified number of seconds.

Retransmit a maximum n times

Sets the number of times to retransmit the Inform Request message.

Community / Confirm Community

For SNMPv1 and SNMPv2c, these settings specify the SNMPv1 or SNMPv2c community name.

Username

The SNMPv3 user name.

Authentication

The SNMPv3 authentication type: **None**, **MD5**, **SHA1**, or **SHA256**.

Authentication Password / Confirm Authentication Password

The SNMPv3 authentication password.

Encryption

The SNMPv3 encryption type: **None**, **DES**, or **AES**.

Encryption Password / Confirm Encryption Password

The SMPv3 encryption password.

4. Click **Apply**.

**Command line**

Command	Instance	Parameter	Values	Equivalent web parameter
snmp	0	enterprisetrap	off, on	Generate Enterprise traps
snmp	0	generictraps	off, on	Generate Generic traps
snmp	0	authtraps	off, on	Generate Authentication Failure traps
snmp	0	vrrptraps	off, on	Generate VRRP traps
snmptrap	0	ipaddr	IP address	Trap Server IP Address
snmptrap	0	port	network port number	Port
snmptrap	0	version		Use SNMP Version
snmptrap	0	sendinforms	off, on	Send "Inform Request" message
snmptrap	0	informto	integer	If no response, retransmit the Inform Request message after n seconds
snmptrap	0	informretries	integer	Retransmit a maximum n times
snmptrap	0	auth	none, md5, sha1, sha256	Authentication
snmptrap	0	authpassword	password	Authentication Password

Command	Instance	Parameter	Values	Equivalent web parameter
snmptrap	0	priv		
snmptrap	0	privpassword	password	
snmptrap	0	ipent		
snmptrap	0	ipadd		

Configuring security

Configure system security settings	751
Configure user security settings	753
Firewall	758
Use a RADIUS client for authentication	800
Use TACACS+ to control access to the router	804
Use command filtering	809

Configure system security settings

Web

1. Go to **Configuration > Security > System**.



The screenshot shows a web configuration page for system security. It has a light gray background with blue headers for sections. The 'System' section is expanded, showing a checkbox for 'Enable password encryption' which is currently unchecked. Below it is a note: 'Note. If you enable password encryption, you will not be able to copy encrypted passwords to other devices.' The 'USB Security' section has a header and a sub-header 'Disable the following USB devices' followed by four unchecked checkboxes: 'All Devices', 'Mass Storage Devices', 'Serial Devices', and 'Hub Devices'. Below these is a checked checkbox for 'Allow autoexec.bat files to run from Mass Storage Devices'. The 'Miscellaneous' section has a checked checkbox for 'Enable "Factory Default" reset button'. At the bottom of the form is a button labeled 'Apply'.

2. Configure settings for system security , securing USB devices, and miscellaneous security settings.

Enable password encryption

By default, passwords stored on the router are not encrypted. They are obfuscated, and you can share unencrypted passwords among devices. Enabling this settings causes encrypts passwords using AES encryption and a key specific to the device. Note, however, that you cannot share encrypted passwords among devices.

USB Security

Disable the following USB devices

You can restrict or disable the USB port for increased router security. This setting enables or disables the router using any of the following USB devices:

- All devices
- Mass storage devices
- Serial devices
- Hub devices

For additional information about restricting use of or disabling the USB port, see [.Manage files using USB storage devices.](#)

Allow autoexec.bat files to run from Mass Storage Devices

Enables/disables running the **autoexec.bat** files from the mass storage devices. For additional details on running autoexec.bat files from mass storage devices, see [Manage files using USB storage devices](#).

Enable “Factory Default” reset button

Enables/disables execution of a complete hardware reset.

3. Click **Apply**.

Command line

Command	Instance	Parameter	Values	Equivalent web parameter
cmd	0	encpasswords	on, off Default is off	Enable password encryption
usbcon	0	dislist	list of USB ports, where: x=1 for the bottom USB port and 2 for the top port. p=<port #> (if connected to a USB hub the port numbers can increase). DRIVER=MSD for Mass Storage Device, SERIAL for serial devices, or HUB for hub devices.	Disable the following USB devices
usbcon	0	batfile	on, off	Allow autoexec.bat files to run from Mass Storage Devices
cmd	0	pbreset	on, off	Enable “Factory Default” reset button

Configure user security settings

Web

1. Go to **Configuration > Security > User**.
The **User** parameter pages allow you to configure several authorized users. The number of users available depends on the firmware build the router is running. Each user has a password and access level that determines the facilities to which the user has access.
2. For each user, configure user parameters

Username

The name of the user. Usernames can be up to **14** characters long. You can use some special usernames:

Username	Description
%s	Uses the serial number of the router as the username.
%i	Uses the IMEI of the cellular module as the username.
%c	Uses the ICCID of the SIM as the username.

If a % symbol is part of the username, you must enter another % character as an escape character. For example **user%1** should be entered as **user%%1**.

Password / Confirm Password

The password for the user. Up to **14** characters are allowed.

Access Level

Selects the access level for the user. There are the following options:

Access level	Access allowed
Super	Allows full access to all facilities.
High	Allows user to reconfigure the general configuration of the router and to change some settings such as the time and date. Not allowed to change user settings.
Medium	Allows user to access medium level configuration commands which allow some configuration of the router.
Low	Allows user to access low level commands which tend to be status and statistics commands.
Read Only	Read only access of the configuration.
None	User is not allowed to login via Web, FTP, SSH, and Telnet.

3. Click **Apply**.

 **Command line**

Command	Instance	Parameter	Values	Equivalent web parameter
user	0	name	String (up to 40 chars)	Username
user	0	password	String (up to 40 chars)	Password
user	0	access	0=Super 1=High 2=Medium 3=Low 4=None 8=Read Only	Access Level

Configure advanced user settings

Web

1. Go to **Configuration > Security > Users > User n > Advanced**.
2. Enter and change advanced user settings as needed.

Allow this user to log in over a PPP network

Enabling this setting allows the user to log in to the router using PPP. Disabling this disables PPP login for the user, no matter their access level.

Use this number x when PPP dial-back is required for this user

The telephone number for the user in the event that dial-back is required. If the username that the remote router uses during the PPP authentication matches the username of the user where a dial-back number is configured, the user's dial-back number overrides any dial-back number configured in the answering PPP interface.

Alternate IKE Key / Confirm Alternate IKE Key

When IKE is the initiator, the responder-supplied HASH is checked using the normal password (above) and if that fails, the Alternate Key (this setting). The initiator remembers which password was successful, and uses that password to create the HASH if it becomes the responder of some new negotiation. If the IKE becomes a responder and IKE negotiations fail after supplying the HASH, the next negotiation uses the other password. Using this Alternate Key, it should be possible to configure new passwords into both ends of a tunnel, and not have too many failed negotiations. The process would be to add the Alternate Key into the remote router, then update the local router with the Alternate Key. Once that has been done, the administrator could move the Alternate Key to the usual location (**Password**) and remove the Alternate Key (**newpwd**) from the configuration. Should a negotiation take place during the period where the Alternate Key has been entered into the remote router, but not the local router, there should be no more than one failed negotiation, and only if the remote router is the initiator.

Remote Peer IP address

In certain circumstances, it may be desirable for a user connecting in over a PPP connection to be allocated a specific IP address, rather than be allocated an address from a pool configured on a PPP interface. When this parameter is configured, the IP address negotiated on the PPP link will be this one, not an address from the regular IP address pool.

Remote Peer IP subnet

If multiple PPP interfaces are enabled for answering and multiple remote routers can dial into the local router, the router cannot always use static routes to ensure that packets which should be routed to the remote network are sent through the correct PPP interface. Use this parameter with the **Remote Peer IP subnet mask** parameter to associate a network subnet with a user. When a remote unit connects in and authenticates with the router, the router creates a dynamic route that will override any static routes for the duration of the PPP session. The interface for the dynamic route is the PPP interface that answered the call. The network address for the dynamic route comes from the entry in the user table matching the username the remote unit used during PPP authentication.

Remote Peer IP subnet mask

The remote subnet mask parameter. Use with the **Remote Peer IP subnet** parameter above to fully qualify the network address for the user.

Public Key file

The name of the file containing the public key for that user. If the public key matches the client supplied public key, the user is allowed access.

Default WEB page

Sets the default web interface page to open for the user.

3. Click **Apply**.

**Command line**

Command	Instance	Parameter	Values	Equivalent web parameter
user	0	dun_en	on, off	Allow this user to log in over a PPP network
user	0	phonenum	Number	Use this number x when PPP dial-back is required for this user
user	0	newpwd	String (up to 14 chars)	Alternate IKE Key
user	0	fieldip	IP Address	Remote Peer IP address
user	0	ipaddr	IP Address	Remote Peer IP subnet
user	0	mask	IP Mask	Remote Peer IP subnet mask
user	0	keyfile	Filename	Public Key file
user	0	defpage	Web page name	Default WEB page

Change the default user name and password for a user

Change the user name and password for device users. The default user name and password are:

- User name: **admin**
- Password: The default password is printed on the device label.

Note If a device with the default password printed on the label is downgraded to a firmware release prior to release 8.x, the default password will be **default**.

- If the password is not on the label, then the default user name is **username**, and the default password is **password**.
- If neither user name/password combination works, the password may have been updated. Contact your system administrator.

Note Record the new password. If the changed password is lost, the router must be reset to the default firmware settings.

Web

1. From the main menu, navigate to **Configuration > Security> Users> User n**.
2. In the **Username** field, enter the new user name. Up to 14 characters are allowed in a username. .
3. In the **Password / Confirm Password** field, enter the new password.
4. Select the access level for the user: **Super, High, Medium, Low, Read Only**, or **None**.
5. Click **Apply**.

Command line

Issue several **user** commands, specifying the **name**, **password**, and **access** parameters.

Firewall

Digi TransPort routers have a comprehensive firewall feature. A firewall is a security system for restricting the type of traffic the router transmits or receives based on a combination of IP address, service type, protocol type, port number, and IP flags. Firewalls minimize the risk of unauthorized access to the local network resources by external users or restrict the range of external resources to which local users have access. For a more detailed description of how firewalls operate on Digi routers, see [Use firewall scripts](#). Review that topic before attempting to implement a firewall.

The rules governing the operation of the firewall are contained in a pseudo-file called **fw.txt**. You can create this file either by using the controls in the **Configuration > Security > Firewall** page in the web interface, or by using a text editor on a PC and then loading the resulting file onto the router using FTP or XMODEM. Digi Routers are shipped with a default **fw.txt** file you can use as the starting point for a custom firewall configuration.

Configure firewall rules

Web

1. Go to **Configuration > Security> Firewall**.

Since a default firewall configuration file is provided, when this page loads, it displays the rules in the default **fw.txt** file. If **fw.txt** does not exist, a blank table is displayed. There are three other buttons that appear just below the table.

Hits

The numbers that appear in this column of the table are the number of hits for the rule that appears to the right.

#

The rule number.

Delete

Deletes the rule that appears to its left.

Insert

Inserts new blank lines above the line on which the button appears. The button at the bottom creates a new blank line at the end of the table. (An empty table contains just the one button at the bottom).

2. To create a new firewall rule, click the button at the point the new rule should appear. A text box appears.
3. Type the firewall rule into the text box and click **OK**. To abandon any changes, click **Cancel**.
4. A validation is performed on the rule you entered. If the rule is valid, it is added to the table. If it contains errors, a warning message displays. Edit or delete the rule.

Edit

These buttons that appear to the right of the rule open up the rule in an edit text box which allows the text to be edited. Click on the **OK** button to commit the changes or **Cancel** to abandon the edit.

Reset Hit Counters

Resets to **0** all the rule hit counts that appear in the left-hand column of the table.

Save

Saves changes to the table to the **fw.txt** file. If the changes are not saved using this button, they will be lost if the router is rebooted or loses power.

Restore

Restores the original **fw.txt** to the table, provided that the changes have not been saved.

Below the firewall editor table is another table that controls the interfaces to which the firewall rules apply.

Interface

A list of the available interfaces to which the firewall rules may be applied.

Enabled

Enables the firewall for that interface.

5. Click **Apply**



Command line

Command	Instance	Parameter	Values	Equivalent web parameter
fw	n/a	logclr	-	Reset Hit Counters
fw	n/a	save	-	Save
fw	n/a	-	-	Restore

To view the firewall rule hits from the command line console, use the **type** command:

```
type fwstat.hit
```

Configure stateful inspection settings

For more information on stateful inspection and firewall rules, see [\[inspect-state\]](#).

Web

To configure stateful inspection settings, go to **Configuration > Security > Firewall > Stateful Inspection Settings**. This page contains timer timeout values and other options for the firewall stateful inspection module. This module establishes firewall rules that last for a single connection only. Typically, the first packet of a TCP connection (SYN packet) creates a stateful inspection rule that only allows subsequent packets for that TCP connection through the firewall. The timers described below set limits on how long such rules persist.

Timer options

TCP Opening *s* seconds

The time following receipt of a TCP packet that causes a stateful inspection rule to be created before a TCP connection must be established. If a TCP connection is not established within this period, the associated stateful rule is removed.

TCP Open *s* seconds

The time an established TCP connection can remain idle before the stateful inspection rule created for it is removed. The timer is restarted each time a packet is processed by the associated stateful inspection rule.

TCP Closing *s* seconds

The time allowed for a TCP socket to close once the first TCP FIN packet has been received. If the timer expires before the socket has completed closing, the stateful inspection rule is removed.

TCP Closed *s* seconds

The time that a stateful inspection rule remains in place after a TCP connection has closed.

UDP *s* seconds

The time that a stateful inspection rule remains in place following the receipt of UDP packet. The timer is restarted each time packets matching the rule pass in each direction. As a consequence, use rules based on UDP only if packets will travel in both directions.

ICMP *s* seconds

Some ICMP packets, such as the ECHO request, generate response packets. The value in this text box specifies the length of time that a stateful inspection rule created for an ICMP packet will remain in place if the response is not received. The rule is removed immediately following receipt of the response.

Other protocols *s* seconds

If a stateful inspection rule is created from a packet type other than TCP, UDP or ICMP, a rule timeout should be created for it. The parameter in this text box specifies the length of time such a rule persists. The timer is restarted each time a packet is processed by the rule.

Other stateful inspection options

Expire entry after n consecutive packets in one direction

The maximum number of consecutive packets that should pass in one direction before the corresponding rule entry is expired.

Count missed UDP echo packets as dropped

Causes the firewall to increment the dropped packet count for each failed echo request in the situation where UDP echo is active on an interface that becomes disconnected.

Command line

Entity	Instance	Parameter	Values	Equivalent web parameter
fwall	0	opening	0-4294967296	TCP Opening s seconds
fwall	0	open	0-4294967296	TCP Open s seconds
fwall	0	closing	0-4294967296	TCP Closing s seconds
fwall	0	closed	0-4294967296	TCP Closed s seconds
fwall	0	udp	0-4294967296	UDP s seconds
fwall	0	icmp	0-4294967296	ICMP s seconds
fwall	0	other	0-4294967296	Other protocols s seconds
fwall	0	maxuni	0-2147483647	Expire entry after n consecutive packets in one direction
fwall	0	cntmissedecho	off, on Default off	Count missed UDP echo packets as dropped

Use firewall scripts

A firewall is a protection and packet filtering system that allows or prevents the transmission of data (in either direction) based on a set of rules. The firewall prevents your local area network from unauthorized external access by other users of the Internet or another wide area network.

Firewall rules allow filtering based on the following criteria:

- Source and destination IP addresses
- Source and destination IP port or port ranges
- Type of protocol in use
- Direction of the data (in or out)
- Interface type
- The route the packet is on
- Whether an interface is OOS (out of service)
- ICMP message type
- TCP flags (**SYN, ACK, URG, RESET, PUSH, FIN**)
- A type of service (TOS) identifier
- Status of a link and/or data packets on UDP/TCP and ICMP protocols

A firewall can also limit the degree of access local users have to external network resources.

A firewall does not provide a complete security solution; it provides only one element of a fully secure system. Consider using additional security methods, such as user authentication and data encryption. See [Configure Internet Protocol security \(IPsec\)](#) for further information.

Besides providing comprehensive filtering facilities, Digi TransPort routers support rules relating to the logging of information for audit/debugging purposes. You can log this information to a pseudo-file on the router called **fwlog.txt**, the **eventlog.txt** pseudo-file, or to a syslog server, and you can also use it to generate SNMP traps.

Firewall script syntax

A firewall must be individually configured to match the needs of authorized users and their applications. On Digi routers, the rules governing firewall behavior are defined in a script file called **fw.txt**. Each line in this file consists of: a label definition, a comment, or a filter rule.

The syntax for a firewall filter rule is as follows. Click each syntax element for more information about each script field.

[\[action\]](#) [\[in-out\]](#) [\[options\]](#) [\[tos\]](#) [\[version\]](#) [\[proto\]](#) [\[dnslist\]](#) [\[ip-range\]](#) [\[inspect-state\]](#)

Using labels

A label definition is a string of up to **12** characters followed by a colon. Labels can only include letters, digits and the underscore character. Use labels with the break option to cause the processing of the script to jump to a new location.

Entering comments in a firewall script

Any line starting with the hash character (**#**) is considered a comment and is ignored.

Firewall script process flow

If you use a firewall script, these are the basic processing rules:

- When the firewall is active, the script is processed one line at a time as each packet is received or transmitted.
- Even when a packet matches a filter-rule, processing continues and all the other filter rules are checked until the end of the script is reached.
- The action taken on a particular packet is that specified by the last matching rule.
- By using the **[action]** field's **break** option, you can redirect the script processing to a new location or to the end of the script if required.
- The default action that the firewall assigns to a packet is to block a packet: if the packet does not match any of the rules.

[action]

The **[action]** firewall script field defines the action to be performed. Allowed values:

- **block**
- **pass**
- **pass-ifup**
- **dscp**
- **vdscp**
- **debug**

These actions operate as follows:

block

Prevents a packet from being allowed through the firewall. When block is specified, an optional field can be included that causes an ICMP packet to be returned to the interface from which that packet was received. You can use blocking to confuse hackers by having different responses to different packets or for fooling an attacker into thinking a service is not present on a network.

The syntax for specifying the return of an ICMP packet is:

```
"return-icmp" [icmp-type [icmp-code]]
```

where:

[icmp_type]

Is a decimal number representing the ICMP type, or one of the predefined text codes listed in the following table:

ICMP type value	ICMP type
1	Unreach
2	Echo
3	Echorep
4	squench
5	redir
6	timex
7	paraprob
8	timest
9	timestrap
10	inforeq
11	inforep
12	maskreg

ICMP type value	ICMP type
13	maskrep
14	routerad
15	routersol

[icmp-code]

An optional decimal number representing the ICMP code of the return ICMP packet. If the **[icmp-type]** is **[unreach]**, the ICMP code can also be one of the following predefined text codes:

ICMP code	Description
net-unr	Network unreachable
host-unr	Host unreachable
proto-unr	Protocol unrecognized
port-unr	Port unreachable
needfrag	Needs fragmentation
srcfail	Source route fail

For example, this rule causes the router to return an ICMP Unreachable packet in response to all packets received on PPP 0:

```
block return-icmp unreach in break end on ppp 0
```

Instead of using the **return-icmp** option to return an ICMP packet, you can use **return-rst** to return a TCP reset packet instead. This would only be applicable for a TCP packet. For example, this rule returns a TCP reset packet when the firewall receives a TCP packet on the Ethernet interface 0 with destination address **10.1.2.***.

```
block return-rst in break end on eth 0 proto tcp from any to 10.1.2.0/24
```

return-icmpv6

In addition to the existing **return-icmp** option, which is used only with IPv4, you can include an optional field that causes an ICMPv6 packet to be returned to the interface from which that packet was received.

The syntax for specifying the return of an ICMP packet is:

```
"return-icmpv6" icmpv6-type [icmpv6-code]
```

where:

[icmpv6_type]

Is a decimal number representing the ICMPv6 type, or one of the predefined text codes listed in the following table:

ICMPv6 type value	ICMPv6 type
1	unreach
2	toobig
3	timex
4	paramprob
128	echo
129	echorep
137	redir
130	mlquery
131	mlreport
132	mldone
133	router-solicit
134	router-advert
135	neighbor-solicit
136	neighbor-advert
138	router-renum

[icmpv6-code]

An optional decimal number representing the ICMP code of the return ICMP packet. If the **[icmpv6-type]** is **[unreach]**, the code can also be one of the following pre-defined text codes:

ICMPv6 code	Description
no-route	No route to destination
prohibited	Communication prohibited
scope-mismatch	IP address scope mismatch
addr-unr	Address unreachable
port-unr	Port unreachable

For example, this rule causes the router to return an ICMPv6 Unreachable packet in response to all IPv6 packets received on **PPP 0**:

```
block return-icmpv6 unreach in break end on ppp 0
```

pass

Allows packets that match the rule to pass through the firewall.

pass-ifup

Allows outbound packets that match the rule to pass through the firewall but only if the link is already active.

debug

Causes the router to tag any packets matching the rule for debug. This means that for every matching rule that is encountered from this point in the script onwards, an entry will be placed in the pseudo-file **FWLOG.TXT**.

dscp

Causes any packets matching this rule to have its DSCP value adjusted according to this rule. The DSCP value of a packet indicates the type of service required. The router uses it in conjunction with QOS (Quality of Service) functions. A decimal or hexadecimal number must follow the **dscp** keyword to indicate the value that should be set.

For IPv6 packets, the traffic class portion of the IPv6 header will be modified with the DSCP value.

vdscp

Similar to the **dscp** action, in that it adjusts the DSCP value in a packet. The difference is that this is a virtual change only, which means that the actual packet is not changed, and that the packet is processed as if it had the DSCP value as indicated. Like the **dscp** action, a decimal or hexadecimal number must follow.

[in-out]

The **[in-out]** firewall script field specifies whether the action applies to inbound or outbound packets. Allowed values are **in** or **out**. When the field is left blank, the rule is applied to any packet regardless of its direction.

[options]

The **[options]** firewall script field defines several options that apply to packets matching the rule.

log

When the **log** option is specified, the router places an entry in the **FWLOG.TXT** file each time it processes a packet that matches the rule. This log normally details the rule that was matched along with a summary of the packet contents.

- If the **log** option is followed by the **body** sub-option, the complete IP packet is entered into the log file so when the log file is displayed, a more detailed decode of the IP packet is shown.
- The **log** field can also be followed by a further sub-option that specifies a different type of log output. This may either be **snmp**, **syslog**, or **event**. If **snmp** is specified, an SNMP trap (containing similar information to the normal log entry), is generated when a packet matches the rule. If **syslog** is specified, a syslog message is sent to the configured syslog manager IP address. This message contains the same information as that entered into the log file, but in a different format.
- If the **body** option has also been specified, some of the IP packet information is also included.
- The size of the syslog message is limited to a maximum of **1024** bytes.
- The syslog message is sent with default priority value of **14**, which expands out to a facility of **USER**, and the priority **INFO**.
- If **event** is specified, the log output is copied to the **eventlog.txt** pseudo-file and the **FWLOG.TXT** file.
- The event log entry contains the line number and hit count for the rule that caused the packet to be logged.

For example, suppose your local network is on subnet **192.168.*.*** and you want to block any packets received on **PPP 0** that were pretending to be on the local network, and log the receipt of any such packets to the **FWLOG.TXT** file and to a syslog server. The filter rule is constructed as follows:

```
block in log syslog break end on ppp 0 from 192.168.0.0/16 to any
```

break

When specifying the **break** option, follow it with a user-defined label name or the predefined end keyword. When followed by a label, the rule processor jumps to that label to continue processing. When followed by the **end** keyword, rule processing is terminated and the packet is treated according to the last matching rule. For example:

```
break ppp_label on ppp 0
# insert rule processing here for packets that are not on ppp 0
break end
ppp_label:
# insert rule processing here for packets that are on ppp 0
```

on

The interface to which the rule applies; must be followed by a valid interface name. For example, if you were only interested in applying a particular rule to packets being transmitted or received by **PPP 0**, you would include **ppp 0** in the rule. Valid interface-names are **eth n**, **tun n** or **ppp n**, where **n** is the instance number.

oneroute

A rule will only match packets associated with the specified eroute. For example, including the option **oneroute 2** causes the rule to only match on packets transmitted or received over Eroute 2. The **oneroute** option can be followed with the keyword **any**, which will match if the packet is on any eroute.

Firewall rules specifying **oneroute** are only allowed with IPv4 rules. Using this keyword implies that the rule should only match on IPv4 packets.

onvlan

Matches packets that have been received on the specified VLAN.

Firewall rules specifying **onvlan** are only allowed with IPv4 rules. Using this keyword implies that the rule should only match on IPv4 packets.

onvrf

Matches packets that have been assigned to the specified VRF.

Firewall rules specifying **onvrf** are only allowed with IPv4 rules. Using this keyword implies that the rule should only match on IPv4 packets.

routeto

When the **routeto** option is specified and the firewall is processing a received packet, if the rule is the last matching rule, the packet is tagged as being required to be routed to the specified interface. For example, the following filter rule ensures all packets from **10.1.*.*** to **1.2.3.4** on the **telnet** port are all routed to **ETH 1**:

```
pass in break end routeto eth 1 from 10.1.0.0/16 to 1.2.3.4 port=telnet
```

Firewall rules specifying **routeto** are only allowed with IPv4 rules. Using this keyword implies that the rule should only match on IPv4 packets.

oosed

Checks the out of service status of an interface. For example, including the option **oosed ppp 1** would cause the rule to match only if interface **PPP 1** is out of service.

Firewall rules specifying **onvlan** are only allowed with IPv4 rules. Using this keyword implies that the rule should only match on IPv4 packets.

[tos]

The **[tos]** firewall script field specifies the Type of Service (TOS) to match. If included, the **[tos]** field consists of the keyword **tos** followed by a decimal or hexadecimal code, identifying the type of service to match.

For IPv6 packets, the traffic class field in the IPv6 header is checked.

For example, to block any inbound packet on **PPP 0** with a TOS of **0**, the rule is:

```
block in on ppp 0 tos 0
```

[version]

The **[version]** firewall script field specifies the IP version to which the rule applies. Allowed values are **ipv4** and **ipv6**.

Match IPv4 packets only

To match on IPv4 packets only, use the **ipv4** keyword:

```
pass in break end on eth 1 ipv4
```

Match IPv6 packets only

To match on IPv6 packets only, use the **ipv6** keyword:

```
pass in break end on eth 1 ipv6
```

The firewall parser ensures that any tokens implying one IP version (such as an IP address) are not mixed with tokens that imply the other version. For example, this means it is not legal to mix the **ipv6** keyword with an IPv4 IP address. If a rule does not specify any keywords that are IP version specific, the rule applies to both IP versions. For example, the following rule allows both IPv4 and IPv6 packets to pass on interface **eth 0**:

```
pass break end on eth 0
```

[proto]

The **[proto]** firewall script field specifies the protocol to match. Specify using the **proto** keyword followed by one of the following protocol identifiers:

Identifier	Meaning
udp	UDP packet
tcp	TCP packet
ftp	FTP packets regardless of port number
icmp	ICMP packet
icmpv6	ICMPv6 packet
decimal number	Decimal number matched to protocol type in IP header

The **[proto]** field is also important when stateful inspection is enabled for a rule (using the **[inspect-state]** field), as it describes the protocol to inspect (see [\[inspect-state\]](#)).

[dnslist]

The **[dnslist]** firewall script field matches packets containing DNS names in a given **dnslist**. Following **dnslist**, there must be a name of a DNS list as specified by the **#dns** command.

For example, consider the following DNS list:

```
#dns gglist www.Digi.co.*,www.*.co.nz
```

The following firewall rule blocks all DNS lookups to DNS names matching the above list:

```
block out break end on ppp 1 proto udp dnslist gglist from any to any port=dns
```

[ip-range]

The **[ip-range]** firewall script field specifies the range of IP addresses and ports to match. The range can be specified in one of several ways. The basic syntax is:

```
ip-range="all" | "from" ip-object "to" ip-object [flags] [icmp]
```

where **ip-object** is an IP address specification. For full details of the syntax with examples, see [Specifying IP addresses and ranges in firewall rules](#).

[inspect-state]

The **[inspect-state]** firewall script field creates rules for stateful inspection. This is a powerful option in which the firewall script includes rules that allow the router to keep track of a TCP/UDP or ICMP session and therefore to only pass packets that match the state of a connection.

You can also use the **[inspect-state]** field to specify an optional OOS (Out Of Service) parameter. The router uses this parameter to mark any route as being out-of-service for a given period of time in the event that the stateful inspect engine has detected an error.

[inspect] field syntax

The **[inspect]** field has the following syntax

```
inspect = ["inspect-state" {"oos" {interface-name|logical-name} secs {t=secs}
{c=count} {d=count}} {r="ping"|"tcp",{secs{secs}}} {rd=x} {dt=secs}{stat}]
```

You can use the **[inspect]** field on its own, or with an optional **oos** (Out Of Service) parameter.

Using stateful inspection in firewall rules

The Digi routing code stack contains a sophisticated scripted stateful firewall and route inspection engine. Stateful inspection is a powerful tool allowing the router to keep track of a TCP/UDP or ICMP session and match packets based on the state of the connection on which they are being carried. In addition to providing sophisticated firewall functionality, the SF/RI engine also provides a number of facilities for tracking the health of routes, marking dead routes as being Out Of Service (OOS) and creating rules for the automatic status checking of routes previously marked as OOS (for use in multilevel backup/restore scenarios).

You can use the firewall to put interfaces into an OOS state, and control how the interfaces return to service. When an interface goes OOS, all routes configured to use that interface will have their route metric set to **16** (the maximum value), meaning that some other route with a lower metric will be selected.

When a firewall stateful inspection rule expires, a decision is made as to whether the traffic being allowed to pass by this rule completed successfully or not. For example, if the stateful rule monitors **SYN** and **FIN** packets in both directions for a TCP socket then that rule will expire successfully. However, if **SYNs** are seen to pass in one direction but no **SYNs** pass in the other direction, the stateful rule will expire and the router will tag this as a failure.

Conditions that tag a stateful rule as a failure

The following conditions tag a stateful rule as a failure:

- Packets have only passed in one direction.
- Ten packets have passed in one direction with no return packets. For TCP, these packets must also be retransmit packets.

How stateful rules can improve firewall security

To better understand how to use stateful inspection, consider setting up a filter to allow all machines on a local network with addresses in the range **10.1.2.*** to access the Internet on port **80**. This example requires one rule to filter the outgoing packets and another rule to filter the responses. At a minimum, the firewall rules to achieve this are as follows:

```
pass out break end on ppp 0 from 10.1.2.0/24 to any port=80
pass in break end on ppp 0 from any port=80 to 10.1.2.0/24
```

In this example:

- The first rule allows outgoing HTTP requests on PPP 0 from any address matching the mask **10.1.2.*** on port **80**.
- The second rule allows HTTP response packets to be received on PPP 0 on port **80** and addressed to an IP address matching the mask **10.1.2.***.
However, this second rule creates a potential security hole. The problem with filtering based on the source port is that you can trust the source port only as much as you trust the source machine. For example, an attacker could perform a port scan and if the source port was set to **80** in each packet, it would get through this filter. Alternatively, on an already compromised system, a Trojan horse might be set up by listening on port **80**.

You can define a more secure firewall using the **inspect-state** field. The stateful inspection system intelligently creates and manages dynamic filter rules based on the type of connection and the source/destination IP addresses.

Applying stateful rules to the above example, you can redesign the script to make it both simpler and more effective.

Since only the first packet in a TCP handshake will have the **SYN** flag set, we can use a rule that checks the **SYN** flag:

```
pass out break end on ppp 0 from 10.1.2.0/24 to any port=80 flags s inspect-state
block in break end on ppp 0
```

At first glance, it appears that the second rule blocks all inbound packets on **PPP 0**. While this may be inherently more secure, it also means users on the network could not receive responses to their HTTP requests, making the rule of little use. This is not a problem because the stateful inspection system creates temporary filter rules based on the outbound traffic.

The first of these temporary rules allows the first response packet to pass because it also has the **SYN** flag set.

Once the connection is established, a second temporary rule is created that passes inbound or outbound packets if the IP address and port number match those of the initial rule, but does not check the **SYN** flag. It monitors the **FIN** flag, so the system can tell when the connection has been terminated. Once an outbound packet with the **FIN** flag is detected along with a **FIN/ACK** response, this temporary rule ceases to exist, and further packets on that IP address/port are blocked.

In the above example:

- If a local user on address **10.1.2.34** issues an HTTP request to a host on **100.12.2.9**, the outward packet would match and be passed.
- At the same time, a temporary filter rule is automatically created by the firewall that will pass inbound packets from IP address **100.12.2.9** that are addressed to **10.1.2.34** port **x** (where **x** is the source port in the original request from **10.1.2.34**).

Using dynamic filters

Using dynamic filters is more secure, because both the source and destination IP addresses/ports are checked. In addition, the firewall automatically checks that the router uses the correct flags for each stage of the communication.

Using such a firewall rule virtually eliminates the potential for a security breach. Even if a hacker could time their attack perfectly, they would still have to do the following:

- Forge a response packet using the correct source address and port, randomly created by the sender of the HTTP request.
- Target the specific IP address that opened the connection.

inspect-state rules are scalable

As another advantage, **inspect-state** rules are scalable, allowing many machines to use the rule simultaneously. In the above example:

- Many machines on the local network could browse the Internet
- The inspection engine would dynamically create precise inward filters as required.
- The inspection engine would close the rules when they are no longer needed.

Protocol types on which the inspect-state option is allowed

The **inspect-state** option is allowed on the following protocol types:

- TCP
- UDP
- The following ICMP packet types:
 - echo
 - timest
 - inforeq
 - maskreq

Use [inspect-state] with flags

You can use the **inspect-state** option with flags. For example, the original script for setting up a filter to allow all machines on a local network with addresses in the range **10.1.2.*** to access the Internet on port **80** was:

```
pass out break end from 10.1.2.33 port>1023 to any port=telnet
pass in break end from any port=telnet to 10.1.2.33 port>1023 flags a
```

Using the **inspect-state** option, you can replace this script with a single filter rule:

```
pass out break end from 10.1.2.33 port>1023 to any port=telnet flags s!a inspect-state
```

No rule is necessary for the return packets. This is because a temporary filter is created that allows only inbound packets to pass if they match sessions set up by this stateful inspection rule.

The flags s!a specification

The **flags s!a** specification ensures that the rule only matches the first packet in a connection. This is because the first packet in a TCP connection has the **SYN** flag on and the **ACK** flag off, and so we only match on that combination. The stateful inspection engine handles matching the rest of the packets for this connection.

Use [inspect-state] with ICMP codes

You can also use the **[inspect-state]** option with ICMP codes. To allow echo requests and allow echo replies, create one rule:

```
pass out break end on ppp 0 proto icmp icmp-type echo inspect-state
```

The advantage of using **inspect-state** besides simply needing one rule is that it leads to a more secure firewall. For example:

- With the **inspect-state** option, the echo replies are not allowed in all the time; they are only allowed in once an echo request has been sent out on that interface.
- When a valid echo reply comes back or there is a timeout, echo replies will be blocked again.
- Furthermore, the full IP address is checked; the IP source and destination must exactly match the IP destination and source of the echo request.
- If you compare this processing to the rule to allow echo replies in without using **inspect-state**, it is not possible to check the source address at all, and the destination address would match any IP address on our network.

ICMP packet types that allow the inspect-state field

You can use the **inspect-state** field with the following ICMP packet types:

ICMP type	Matching ICMP type
Echo	Echo reply
Timest	Timestrep
Inforeq	Inforep
Maskreq	Maskrep

Use [inspect-state] with ICMPv6 codes

You can use the **inspect-state** field with the following ICMPv6 packet types:

ICMPv6 type	Matching ICMPv6 type
Echo	Echo reply

Use the Out Of Service (oos) parameter in inspect-state fields

The optional **oos** parameter in an **inspect-state** field does several things:

- Allows the stateful inspect engine to mark as **out of service** any routes associated with the specified interface.
- Controls how the interfaces are returned to service.

Routes that use the **oos** parameter are marked as **out of service** only if the specified **oos** option parameters are met.

Note For IPv6 packets, none of the **oos** options are supported.

Syntax

```
oos {interface-name|logical-name} secs {t=secs} {c=count} {d=count}
{r="ping"|"tcp",{secs}}
```

interface-name or logical-name

The interface with which the firewall rule is associated, such as **PPP 1**. This can also be a logical interface name which is simply a name that can be created (such as **waffle**). When a logical interface

name is specified then this name can become **oos (out of service)** and can be tested in other firewall rules with the **oosed** keyword.

secs

The length of time, in seconds, for which the routes that are using the specified interface are marked as out of service.

{t=secs}

Optional. The length of time in seconds the router will wait for a response the packet that matched the rule.

{c=count}

Optional. The number of times the stateful inspection engine must trigger the rule before the route is marked as out of service.

{d=count}

Optional. The number of times the stateful inspection engine must trigger the rule before the interface is deactivated. This parameters applies to PPP interfaces only.

{r="ping"|"tcp",{secs},{secs}}

Optional. Specifies a recovery procedure. When a recovery procedure is specified, the link is tested after the oos timeout has expired. The link is tested by either sending a TCP **SYN** packet or a ping packet to the address/port that caused the oos condition. The **secs** field specifies the retry time when checking for recovery. Only when the recovery succeeds will the interface be in service again.

Example: using the oos parameter for UDP packets

An example set of firewall rules for UDP packets that uses the **oos** parameter is:

```
pass in
pass out
pass out on ppp 1 proto udp from any to 156.15.0.0/16 port=1234 inspect-state oos
ppp 1 300 t=10 c=2 d=2
```

In this example:

- The first two rules configure the router to allow any type of packets to be transmitted or received. The default action of the firewall is to block all traffic.

- The third rule is more complex:
 - It configures the stateful inspection engine to watch for UDP packets (with any source address) being routed via the **PPP 1** interface to any address that begins with **156.15** on port **1234**.
 - If a hit occurs on this rule, but the router does not detect a reply within **10** seconds (as specified by the **t=** parameter), it increments an internal counter.
 - When this counter reaches the value set by the **c=** parameter, the stateful inspection engine marks the **PPP 1** interface (and therefore any routes using it), as being out of service for **300** seconds.
 - Similarly, if this counter matches the **d=** parameter, the stateful inspection engine deactivates **PPP 1**.
 - The stateful inspection engine marks any routes that use **PPP 1** as out of service AND deactivates **PPP 1** if no reply is detected within **10** seconds for two packets in a row.
 - Routes come back into service when either the specified timeout expires or if there are no other routes with a higher metric in service.
 - PPP interfaces re-activate when the routes using them are back in service and there is a packet to route and the AODI mode parameter is set to **On**.

Example: using the oos parameter for TCP packets

An example set of firewall rules for TCP packets that uses the **oos** parameter is:

```
pass out log break end on ppp 3 proto tcp from any to 192.168.0.1 flags S!A
inspect-state oos 30 t=10 c=2 d=2
pass in
pass out
```

- This rule specifically traces attempts to open a TCP connection on **PPP 3** to the **192.168.0.1** IP address and if it fails within 10 seconds twice in a row, will cause the **PPP 3** interface to be flagged as out of service (such as its metric will be set to 16), for 30 seconds.
- The optional **d=2** entry also deactivates the PPP link. Deactivating the link can be useful in scenarios where renegotiating the PPP connection is likely to resolve the problem.
- If a matching route with a higher metric is defined, the router uses it while **PPP 3** routes are out of service, thus providing a powerful route backup mechanism.

Use [inspect-state] with the stat option

You can use the **inspect-state** with the **stat** option. The **stat** option causes this firewall rule to record statistics associated with this firewall rule. Transaction times, counts and errors are recorded under the PPP statistics with this option.

Create a basic inspect-state rule with no out of service options

This example firewall rule allows TCP packets from **10.1.1.1** to **10.1.2.1** port **23** with the **SYN** flag set to pass out on **PPP 2**. Because the rule uses the **inspect-state** field, a stateful rule is set up allowing other packets for that TCP socket to also pass.

```
pass out break end on PPP 2 proto TCP from 10.1.1.1 to 10.1.2.1 port=telnet flags S!A inspect-state
```

Create a rule to mark and interface out of service

Using the above basic inspect-state rule, you can modify the rule to mark an interface out of service if a stateful rule identifies a failed connection:

```
pass out break end on PPP 2 proto TCP from 10.1.1.1 to 10.1.2.1 port=telnet flags
S!A inspect-state oos 60
```

The addition of **oos 60** means if the stateful rule sees a failure, interface **PPP 2** sets the **PPP 2** interface out of service for **60** seconds. If no interface is specified after the **oos** keyword, the interface set to out of service is the one on which the packet is currently passing.

You can set a different interface to out of service by specifying the interface after the **oos** keyword. For example, **oos ppp 1 60** sets interface **PPP 1** out of service for **60** seconds.

Override the default time in a stateful rule

To override the default time allowed by the stateful rule for a connection to open, use the **{t=secs}** option. For example, to override the default TCP opening time of **60** seconds to **10** seconds:

```
pass out break end on PPP 2 proto TCP from 10.1.1.1 to 10.1.2.1 port=telnet flags
S!A inspect-state oos 60 t=10
```

A socket now has **10** seconds to become established (such as exchange SYNs) before the stateful rule expires and is tagged as a failure.

Set an interface to out of service after consecutive failures

You can configure the firewall so the interface is only set to out of service after a number of consecutive failures occur. To do this, use the **{c=count}** option. For example:

```
pass out break end on PPP 2 proto TCP from 10.1.1.1 to 10.1.2.1 port=telnet flags
S!A inspect-state oos 60 t=10 c=5
```

PPP 2 will now only be set to out of service after **5** consecutive failures.

Deactivate an interface after consecutive failures

You can deactivate the interface after a number of consecutive failures. This is useful for WWAN interfaces, which may get into a state where the PPP connection appears to be operational, but in fact no packets are passing. In this case, deactivating and reactivating the interface sometimes fixes the problem. For example:

```
pass out break end on PPP 2 proto TCP from 10.1.1.1 to 10.1.2.1 port=telnet flags
S!A inspect-state oos 60 t=10 c=5 d=10
```

Now, **PPP 2** will be deactivated after **10** consecutive failures.

Specifying IP addresses and ranges in firewall rules

ip-range

The **ip-range** field of a firewall script rule identifies the IP address or range of addresses to which the rule applies. The syntax for specifying an IP address range is:

```
ip-range = "all" | "from" ip-object "to" ip-object [ flags ] [ icmp ] [icmpv6]
```

where:

```
ip-object = addr [port-comp | port-range]
```

```
flags = "flags" { flags } [ !{ flags } ]
```

```
icmp = "icmp-type" icmp-type [ "code" decnum ]
```

```
addr = "any" | ip-addr| ipv6-addr | ipv6-host | addr6-eth | addr6-ppp [
"/"decnum ] [ "mask" ip-addr | "mask" hexnum ]
```

```
port-comp = "port" compare port-num
```

```
port-range = "port" port-num "<>" | "><" port-num
```

```
ip-addr = IP address in format nnn.nnn.nnn.nnn
```

```
decnum = a decimal number
```

```
hexnum = a hexadecimal number
```

```
compare = "=" | "!=" | "<" | "<=" | ">" | ">="
```

```
port-num = service-name | decnum
```

```
service-name = "http" | "telnet" | "ftpd" | "ftpcnt" | "pop3" | "ike"
| "xot" | "sntp" | "smtp"
```

In the above syntax definition:

- Items in quotes are keywords.
- Items in square brackets are optional.
- Items in curly braces are optional and can be repeated.
- The vertical bar symbol ("|") means or.

ip-object

An **ip-object** consists of an IP address and an IP port specification, preceded by the keyword **from** or **to** to define whether it is the source or destination address. The most basic form for an **ip-object** is an IP address preceded **by** **from** or **to**. For example, to block all packets destined for address 10.1.2.98 the script rule is:

```
block out from any to 10.1.2.98
```

You can specify an **ip-object** using an address mask, describing which bits of the IP address are relevant when matching. The script processor supports two formats for specifying masks:

- **Method 1:** The IP address is followed by a forward slash and a decimal number. The decimal number specifies the number of significant bits in the IP address. For example, if you wanted to block all packets in the range **10.1.2.*** the rule would be:

```
block from any to 10.1.2.0/24
```

such as, only the first 24 bits of the address are significant.

- **Method 2:** This same rule could be described another way using the mask keyword:

```
block from any to 10.1.2.0 mask 255.255.255.0
```

The IP address can also contain either **addr-ppp n** or **addr-eth n**, where **n** is the **eth** or **ppp** instance number. In this case, the rule specifies that the IP address is that allocated to the PPP interface or to the Ethernet interface. This is useful when IP addresses are obtained automatically and therefore are not known by the author of the filtering rules. For example:

```
block in break end on ppp 0 from addr-eth 0 to any
```

ipv6-addr

Is an IPv6 address in the usual format (e.g. 2001:DB8::/32).

ipv6-host = "ipv6-host" ipv6-addr "/" decnumber ["/" decnumber]

Specifies to host portion of an IPv6 address. For example, the **ipv6-host** value **::01:1111:2222:3333:4444/72** matches the 72 low-order bits of the address **::01:1111:2222:3333:4444**. You can also specify a second decimal value to indicate how many host bits to match. For example, the **ipv6-host** value **::01:1111:2222:3333:4444/72/8** matches the 8 bits of the address starting from bit **128 - 72** (that is, **01**).

addr6-eth = "addr6-eth" decnumber | "addr6-eth-lla" decnumber | "addr6-eth-ula" decnumber | "addr6-eth-global" decnumber

addr6-eth is used to match on IPv6 addresses owned by the Ethernet interface specified by the value of decnumber.

The **-lla** variant is used to match only on the link-local addresses associated with the interface.

The **-ula** variant is used to match only on the unique local addresses associated with the interface.

The **-global** variant is used to match only on the global addresses associated with the interface.

For example, the following rule will pass incoming packets with destination address that matches a link-local address associated with **eth 0**:

```
pass in break end from any to addr6-eth-lla 0
```

The following rule will pass incoming packets with destination address that match any IPv6 associated with **eth 0**.

```
pass in break end from any to addr6-eth 0
```

addr6-ppp = "addr6-ppp" decnumber | "addr6-ppp-lla" decnumber | "addr6-ppp-ula" decnumber | "addr6-ppp-global" decnumber

addr6-ppp is similar to **addr-eth**, but matches on PPP interfaces instead of Ethernet interfaces.

Address/Port translation

One further option for specifying addresses is to use address translation. The syntax for this is:

```
srcdst = "all | fromto [-> [ip-object] "to" object]
```

such as directly after the IP addresses and port are specified. An optional **->** can follow, indicating that the addresses/ports should be translated. The first source object is optional, as it is more normal to translate the destination address.

The following example reroutes packets originally destined for **10.10.10.12** to **10.1.2.3**:

```
pass out break end from any to 10.10.10.12 -> to 10.1.2.3
```

In addition, complete subnets can have NAT applied. The address bits not covered by the subnet mask are taken from the original IP address. For example, to NAT the destination subnet of **192.168.0.0/24** to be **192.168.1.0/24**, the firewall rule is:

```
pass out break end from any to 192.168.0.0/24 -> to 192.168.1.0/24
```

Address/port translation is not supported with IPv6 packets. A parsing error will be generated if a rule mixes address translation with IPv6-specific keywords.

Set filters in firewall rules

Filter on port numbers

Suppose a Telnet server is running on a machine on IP address **10.1.2.63**, and you want to make this server accessible. Suppose also a filter is in place to block all packets to **10.1.2.***. To make the Telnet server available on **10.1.2.63**, add the following line before the blocking rule:

```
pass in break on from any to 10.1.2.63 port=23 flags S!A inspect-state
```

A packet sent to the Telnet server (port **23**) on IP address **10.1.2.63** matches this rule, and further checking is prevented by the break end option.

Specifying **in** ensures that only incoming packets match the rule.

Specifying **flags S!A** ensures that the rule only matches on the initial TCP SYN, and also implies that the rule should match on TCP packets.

Specifying **inspect-state** means that if a packet matches the rule, a new stateful entry is created to allow other packets matching the same TCP socket, in either direction, to pass.

The above example illustrates the = comparison. Other comparison methods supported are:

Symbol	Meaning
!=	not equal
>	greater than
<	less than
<=	less than or equal to
>=	greater than or equal to

You can also specify a port in range or a port out of range with the >< or <> symbols. For example, to pass all packets to addresses in the range **23** to **28**, the rule is:

```
pass break end from any to 10.1.2.63 port 23><28
```

To simplify ports references, some common port numbers are associated with the predefined strings, listed in the table below. For example, in the example above, if we substitute the number **23** with the string **telnet**, the rule is:

```
pass break end from any to 10.1.2.63 port=telnet
```

Other defined port keywords are as follows. The service keywords are predefined based on standard port numbers. These port numbers may have been defined differently on your system, in which case you should use the port numbers explicitly, and not the defined names.

Keyword	Standard port number	Service
Ftpdat	20	File Transfer Protocol data port
Ftpcnt	21	File Transfer Protocol control port

Keyword	Standard port number	Service
telnet	23	Telnet server port
smtp	25	SMTP server port
http	80	Web server port
pop3	110	Mail server port
sntp	123	NTP server port
ike	500	Source/destination port for IKE key
xot	1998	Destination port for XOT packets

Filter on TCP flags

To filter on TCP flags, follow an **ip-object** by an optional **[flags]** field.

[flags]

Filters based on any combination of TCP flags. The **[flags]** field specifies the flags to check and consists of the flags keyword followed by a string specifying the flags themselves. Each letter in this string represents a particular flag type as listed below:

Code	Flag
f	FIN Flag
r	RESET Flag
s	SYN Flag
p	PUSH Flag
u	URG Flag
a	ACK Flag

These flag codes allow the filter to check any combination of flags.

Following on from the previous example, to block packets that have all the flags set you would need to precede the pass rule with the following block rule:

```
block break end from any to 10.1.2.0/24 port=telnet flags frspua
```

Here, the list of flags causes the router to check that those flags are set. This list may be optionally followed by an exclamation mark (!) and a second list of flags that the router should check for being clear.

For example, the following **[flags]** field tests for the **s** flag being on and the **a** flag being off with all other flags ignored.

```
f!a
```

As a further example, suppose we want to allow outward connections from a machine on **10.1.2.33** to a Telnet server. We have to define a filter rule to pass outbound connections and the inbound response packets. Because this is an outbound Telnet service we can make use of the fact that all

incoming packets will have their **ACK** bits set. Only the first packet establishing the connection will have the **ACK** bit off. The filter rules to do this would look like this:

```
pass out break end from 10.1.2.33 port>1023 to any port=telnet
pass in break end from any port=telnet to 10.1.2.33 port>1023 flags !a
```

The first rule allows the outward connections, and the second rule allows the response packets back in which the **ACK** flag must always be on. This second rule will filter out any packets that do not have the **ACK** flag on. This will bar any attackers from trying to open connections onto the private network by simply specifying the source port as the Telnet port. Note that there is a simpler way to achieve the same effect using the inspect state option, described below.

Filter on ICMP codes

An **ip-object** can be followed by an optional **[icmp]** field.

[icmp]

Allows the script to filter packets based on ICMP codes. ICMP packets are occasionally employed to debug and diagnose a network and can be extremely useful. However, they form part of a low-level protocol and are frequently exploited by hackers for attacking networks. For this reason, most network administrators want to restrict the use of ICMP packets.

The syntax for including ICMP filtering is:

```
icmp = "icmp-type" icmp-type ["code" decnum]
```

icmp-type

Is one of the pre-defined strings listed in the following table or the equivalent decimal numeric value:

ICMP type	ICMP value
Unreach	3
Echo	8
Echorep	0
Squench	4
Redir	5
Timex	11
Paramprob	12
Timest	13
Timestrep	14
Inforeq	15
Inforep	16
Maskreq	17
Maskrep	18

ICMP type	ICMP value
Routerad	9
Routersol	10

The following two rules are equivalent:

```
pass in break end on ppp 0 proto icmp from any to 10.1.2.0/24 icmp-type 0
pass in break end on ppp 0 proto icmp from any to 10.1.2.0/24 icmp-type echorep
```

Both of these rules allow echo replies to come in from interface **ppp 0** if they are addressed to our example local network address (**10.1.2.***).

In addition to having a type, ICMP packets also include an ICMP code field after the type. When specified, the code field must also match. Specify the ICMP code field with a decimal number.

For example, to allow only echo replies and ICMP unreachable type ICMP packets from interface **ppp 0**. Then the rules would look something like this:

```
pass in break end on ppp 0 proto icmp from any to 10.1.2.0/24 icmp-type echorep code 0
pass in break end on ppp 0 proto icmp from any to 10.1.2.0/24 icmp-type unreachable code 0
block in break end on ppp 0 proto icmp
```

The first two rules in this set allow in the ICMP packets that we are willing to permit and the third rule denies all other ICMP packets in from this interface. If we ever expect to see echo replies in on **ppp 0**, we should allow echo requests out on that interface too, using this rule:

```
pass out break end on ppp 0 proto icmp icmp-type echo
```

[icmpv6]

This field allows the script to filter packets based on ICMPv6 codes. ICMPv6 packets are occasionally used to debug and diagnose a network and can be extremely useful. However, they form part of a low-level protocol and are frequently exploited by hackers for attacking networks. For this reason, most network administrators want to restrict the use of ICMP packets.

The syntax for including ICMPv6 filtering is:

```
icmpv6 = "icmpv6-type" icmpv6-type ["code" decnum]
```

Where:

icmpv6-type

Is one of the pre-defined strings listed in the following table or the equivalent decimal numeric value:

ICMPv6 type	ICMPv6 value
Unreach	1
Toobig	2
Timex	3
Paramprob	4

ICMPv6 type	ICMPv6 value
Echo	128
Echorep	129
Redir	137
Miquery	130
Mireport	131
Midone	132
Router-solicit	133
Router-advert	134
Neighbor-solicit	135
Neighbor-advert	136
Router-renum	138

The following two rules are equivalent:

```
pass in break end on ppp 0 proto icmp from any to 2001:db8::/32 icmpv6-type 129
pass in break end on ppp 0 proto icmp from any to 2001:db8::/32 icmpv6-type
echorep
```

Assign Differentiated Services Code Point (DSCP) values

When using Quality of Service (QoS), packet priorities are determined by the DSCP values in their **[tos]** (type of service) fields. These priorities may have already been assigned but if necessary, the router can be configured to assign them by inserting the appropriate rules in the firewall. This is done by using the **dscp** command.

For example, the following rule sets the DSCP value to **46** for almost any type of packet received on **ETH 0** from IP address **100.100.100.25** addressed to **1.2.3.4** on port **4000**. This allows you to set the DSCP value for almost any type of packet.

```
dscp 46 in on eth 0 from 100.100.100.25 to 1.2.3.4 port=4000
```

The following rule sets outgoing mail traffic to the same top-priority queue (**46** is, by default, a very high priority code in the DSCP mappings):

```
dscp 46 in on eth 0 proto smtp from any to any
```

Log firewall events

When the log option is specified within a firewall script rule, an entry is created in the **fwlog.txt** pseudo-file each time an IP packet matches the rule. Each log entry contains the following information:

Parameter	Description
Timestamp	The time when the log entry is created.
Short Description	Usually FW LOG but could be FW DEBUG for packets that hit rules with the debug action set.
Dir	Either IN or OUT . Indicates the direction the packet is traveling.
Line	The line number of the rule that cause the packet to be logged.
Hits	The number of matches for the rule that caused this packet to be logged.
Iface	The Interface the packet was to be transmitted/received on.
Source IP	The source IP address in the IP packet.
Dest. IP	The destination IP address in the IP packet.
ID	The value of the ID field in the IP packet.
TTL	The value of the TTL field in the IP packet.
PROTO	The value of the protocol field in the IP packet. This will be expanded to text as well for the well-known protocols.
Src Port	The value of the source port field in the TCP/UDP header.
Dst Port	The value of the source port field in the TCP/UDP header.
Rule Text	The rule that caused the packet to be logged is also entered into the log file.

In addition, port numbers are expanded to text predefined port numbers.

Example log file entries

Log entry without the body option

```

----- 15-8-2002 16:25:50 -----
FW LOG Dir: IN Line: 11 Hits: 1 IFACE: ETH 0
Source IP: 100.100.100.25 Dest IP: 100.100.100.50 ID: 39311 TTL: 128
PROTO: TCP (6)
Src Port: 4232 Dst Port: WEB (80)
pass in log break end on eth 0 proto tcp from 100.100.100.25 to addr-eth 0
flags S/SA inspect-state
-----

```

Log entry with the body option

```

----- 15-8-2002 16:27:56 -----
FW LOG Dir: IN Line: 7 Hits: 1 IFACE: ETH 0
Source IP: 100.100.100.25 Dest IP: 100.100.100.50 ID: 40140 TTL: 128
PROTO: ICMP (1)
block return-icmp echorep log body break end proto icmp icmp-type echo
From REM TO LOCIFACE: ETH 0
45 IP Ver: 4
Hdr Len: 20
00 TOS: Routine
Delay: Normal
Throughput: Normal
Reliability: Normal
00 3C Length: 60
9C CC ID: 40140
00 00 Frag Offset: 0
Congestion: Normal
May Fragment
Last Fragment
80 TTL: 128
01 Proto: ICMP0C E1 Checksum: 3297
64 64 64 19 Src IP: 100.100.100.25
64 64 64 32 Dst IP: 100.100.100.50
ICMP:
08 Type: ECHO REQ
00 Code: 0
04 5C Checksum: 1116
-----

```

Text included in the eventlog.txt pseudo-file when the event sub-option is specified

```

16:26:32, 15 Aug 2002,Firewall Log Event: Line: 10, Hits: 3
IP Filter -
Filter Rule: block return-icmp unreachable host-unr in log syslog break end on eth 0
proto tcp from any to 100.100.100.50 port=telnet
Line: 10
Hits: 4

```

Syslog message where the body option is not specified

```

2002-09-04 16:30:06 User.Info100.100.100.50Aug 15 16:31:59 arm.1140

```

Syslog message with the body option specified

```

2002-08-30 16:19:59 User.Info100.100.100.50Aug 10 16:21:56 arm.1140
IP Filter - Filter Rule: block return-icmp unreachable port-unr in log body syslog
break end on eth 0 proto tcp from any to 100.100.100.50 port=telnet
Line: 9
Hits: 3
PKT:
Source IP: 100.100.100.25
Dest IP: 100.100.100.50
ID: 13317
TTL: 128
Protocol: TCP
Source Port: 1441

```

Dest Port: 23
TCP Flags: S

Keep a route out of service and use recovery

You may want to keep an interface out of service until you are sure that a future connection will work. To do this, specify one or more recovery options. These options get the router to test connectivity between the router and the destination IP address of the packet that established the stateful rule. The recovery can be in the form of a **ping** or a TCP socket connection. You must also specify an interval between recovery checks. For example:

```
pass out break end on PPP 2 proto TCP from 10.1.1.1 to 10.1.2.1 port=telnet flags S!A inspect-state oos 60 t=10 c=5 d=10 r=tcp,120
```

Now the interface is set to OOS for **60** seconds after **5** consecutive failures. After the **60** seconds elapses, the recovery procedure initiates. In this example, the recovery consists of TCP connection attempts executed at **2-minute** intervals. The interface remains OOS until the recovery procedure completes successfully. The destination IP address in this case is **10.1.2.1**.

To override the default socket connection time, specify an additional recovery option. For example:

```
pass out break end on PPP 2 proto TCP from 10.1.1.1 to 10.1.2.1 port=telnet flags S!A inspect-state oos 60 t=10 c=5 d=10 r=tcp,120,10
```

Now, **10 seconds** is allowed for each recovery attempt. If the socket connects within that time, the recovery is successful, else the recovery is unsuccessful.

The **{rd=x}** option disconnects the interface after a recovery attempt completes. Use this option to deactivate the interface after a recovery failure, success, or either. **x** is a bitmask indicating when the interface should be deactivated. Bit **0** deactivates the interface after a recovery failure. Bit **1** deactivates the interface after a recovery success, such as:

- **rd=1** means deactivate after a recovery failure.
- **rd=2** means deactivate after a recovery success.
- **rd=3** means deactivate after either recovery success or recovery failure.

Extending our firewall rule to include this option, the resulting rule is:

```
pass out break end on PPP 2 proto TCP from 10.1.1.1 to 10.1.2.1 port=telnet flags S!A inspect-state oos 60 t=10 c=5 d=10 r=tcp,120,10 rd=3
```

Now the interface is deactivated after a recovery success or failure.

If the rule does not use the **{rd=x}** option, the interface remains up until its inactivity timer expires, or it is deactivated by some other means.

Use the **{dt=secs}** option to indicate that the interface is to remain OOS when it is disconnected, and that it should be reactivated some time after it last disconnected. Recovery procedures start after the interface connects.

Extending our firewall rule to include this option gives:

```
pass out break end on PPP 2 proto TCP from 10.1.1.1 to 10.1.2.1 port=telnet flags S!A inspect-state oos 60 t=10 c=5 d=10 r=tcp,120,10 rd=3 dt=60
```

Now, the interface reconnects **60** seconds after it disconnects and recovery procedures start after the interface connects. Normally, use this option with the **{rd=x}** option so that recovery has control over when the interface connects and disconnects.

Keep a route out of service and use recovery with a list of addresses

This syntax expands on the functionality above, and checks connectivity to a range of addresses using a **ping** command. You can specify an address list that the recovery mechanism will ping in turn to see if any respond. This helps ensure that even when one, two, or three destinations cannot be reached due to an outage on the remote network, the connection will be made available again if at least one of the addresses in the list responds.

The address lists are created using the following syntax:

```
#addr <list-name> <address1,address2,address3,address4>
```

Address lists can span multiple lines if required, for example:

```
#addr <list-name> <address1,address2>
#addr <list-name> <address3,address4>
```

The address list is called using the recovery option **pingl**. An example firewall rule is:

```
pass out break end on PPP 1 proto ICMP from 10.1.1.1 to 10.1.2.1 inspect-state
oos 60 t=10 c=5 d=10 r=pingl listA ,120,10 rd=3 dt=60
```

This rule allows pings outbound, and on detecting a communication failure, it uses pings to a address list named **listA**. The address list named **listA** could look like this:

```
#addr listA 10.1.2.1,10.1.3.1,10.1.4.1,10.1.5.1
#addr listA 10.1.6.1,10.2.1.1,10.2.2.1
```

This causes the recovery to ping the range of address shown in the list above.

Debug a firewall

When creating and managing firewall scripts, the scripts may need debugging to ensure that packets are being processed correctly. To assist in this, you can use a rule with the debug action.

If a rule with the **debug** action is encountered, an entry is made in the **fwlog.txt** pseudo-file each time the packet in question matches a rule from that point on. This allows you to follow a packet through a rule set, and can help determine what, if any, changes are required to the rule set. Rules specifying the debug action are typically placed near the top of the rule set, so all matching rules from that point on are entered into the log file.

You can identify entries created in the **fwlog.txt** file as the result of a debug rule using the short description **FW_DEBUG** at the top of the log entry.

An example rule set using a debug rule:

```
debug in on ppp 2 proto tcp from any to any port=http
pass in break end proto tcp from any to any port=http flags s/sa inspect state
pass out break end proto udp
```

If placed at the top of the rule set, any packet received on interface **PPP 2** to destination port **80** generates a debug entry in the log file for each subsequent rule that it matches. In the example rule set above, a packet that matched the second rule would also match the first rule, and would therefore create two log entries. The same packet would not match the third rule, and so no log entry would be made for this rule.

Because of the extra processor time required to add all of these additional log entries, debug rules should be removed (or commented out) once the rule set is operating as desired.

Use a RADIUS client for authentication

You can use a RADIUS client for authentication purposes at the start of remote command sessions, SSH sessions, FTP sessions, HTTP sessions and Wi-Fi client connections (PEAP & EAP-TLS). Depending on how the RADIUS client is configured, the router may authenticate with one or two RADIUS servers, or may authenticate a user locally using the existing table configured on the router.

There are two RADIUS client configurations: **RADIUS Client 0** and **RADIUS Client 1**. Both have specific functions and the correct instance (0, 1, or both) should be configured depending on the requirements.

To use RADIUS for authenticating router administration access, configure **RADIUS Client 0**. To use RADIUS for authenticating Wi-Fi clients, configure **RADIUS Client 1**.

When the router has obtained the remote user username and password, the RADIUS client passes this information (from the Username and Password attributes) to the specified RADIUS server for authorization. The server should reply with an **ACCEPT** or **REJECT** message.

You can configure the RADIUS client with up to two Network Access Servers (NAS). Depending on system requirements, you can turn on or off local authentication.

During user authentication, the configured RADIUS servers are contacted first. If a valid **ACCEPT** or **REJECT** message is received from the server, the user is allowed or denied access respectively. If no response is received from the first server, the second server is tried (if configured). If that server fails to respond, the router uses local authentication unless disabled. If both servers are unreachable and local authentication is disabled, all authentication attempts fail.

If a RADIUS server replies with a **REPLY-MESSAGE** attribute (**18**), the message is displayed after the login attempt and after any configured “post-banner” message. The router will then display a **Continue Y/N?** prompt to the user. If **N** is selected, the remote session is terminated. This applies to remote command sessions and SSH sessions only.

If the login attempt is successful and the server sends an **IDLE-TIMEOUT** attribute (**28**), the idle time specified will be assigned to the remote session. If no **IDLE-TIMEOUT** attribute is sent, the router applies the default idle timeout values to the session.

The access level is determined by the value of the **SERVICE-TYPE** attribute returned by the RADIUS server. Administrative access is determined by the value **6** being returned by the server. Any other value or no value returned will result in the access level **low** being assigned.

When the session starts and ends, the router sends the RADIUS accounting **START/STOP** messages to the configured server. Again, if no response is received from the primary accounting server, the secondary server will be tried. No further action is taken if the secondary accounting server is unreachable.

Because the router has separate configurations for authorization and accounting servers, you can configure the router to perform authorization functions only, accounting only, or both. An example of how to use this is to perform local authorizations, but send accounting start/stop records to an accounting server.

Web

1. Go to the **Configuration > Security > Radius > RADIUS Client n**.
2. Configure the RADIUS client settings for the route:

▼ RADIUS

▼ RADIUS Client0

RADIUS can be used to authenticate remote command, SSH, FTP and Web sessions. You can configure two servers. The secondary server is used if there is no response from the primary server.

Local authentication can be used if there is no response from the configured servers.

RADIUS accounting can be used to log authentication attempts.

Authorization

Primary Authorization Server

Hostname:

NAS ID:

Password:

Confirm Password:

Secondary Authorization Server

Hostname:

NAS ID:

Password:

Confirm Password:

Enable local authorization if there is no response from the authorization server(s)

Accounting

Primary Accounting Server

Hostname:

NAS ID:

Password:

Confirm Password:

Secondary Accounting Server

Hostname:

NAS ID:

Password:

Confirm Password:

▶ Advanced

Apply

Authorization

Primary Authorization Server

IP Address a.b.c.d

The IP address of the primary authorization NAS.

NAS ID

An identifier passed to the primary authorization NAS. Identifies the RADIUS client. The primary authorization NAS administrator supplies the appropriate value.

Password

The password supplied by the primary authorization NAS administrator. This password and the primary authorization NAS ID are entered to authenticate RADIUS packets.

Confirm Password

Type the above password into this text box so that the router can determine if the two are identical.

3. Click **Apply**.

Command line

Command	Instance	Parameter	Values	Equivalent web parameter
radcli	0, 1	server	Valid IP Address a.b.c.d	Primary Authorization Server IP Address
radcli	0, 1	nasid	Up to 80 characters	Primary Authorization Server NAS ID
radcli	0, 1	password	Up to 40 characters	Primary Authorization Server Password
radcli	0, 1	server2	Valid IP Address a.b.c.d	Secondary Authorization Server IP Address
radcli	0, 1	nasid2	Up to 80 characters	Secondary Authorization Server NAS ID
radcli	0, 1	password2	Up to 40 characters	Secondary Authorization Server Password
radcli	0, 1	localauth	off, on Default: on	Enable local authorization if there is no response from the authorization server(s)
radcli	0, 1	aserver	Valid IP Address a.b.c.d	Primary Accounting Server IP Address
radcli	0, 1	anasid	Up to 80 characters	Primary Accounting Server NAS ID
radcli	0, 1	apassword	Up to 40 characters	Primary Accounting Server Password
radcli	0, 1	aserver2	Valid IP Address a.b.c.d	Secondary Accounting Server IP Address
radcli	0, 1	anasid2	Up to 80 characters	Secondary Accounting Server NAS ID
radcli	0, 1	apassword2	Up to 40 characters	Secondary Accounting Server Password

Configure advanced RADIUS client parameters

Web

1. Go to **Configuration > Security> Radius> Radius Client n> Advanced**.

Enter advanced settings as needed:

Use Source IP Address

If required, select an alternative source interface and instance. Select the required interface from the drop-down list and enter the interface instance in the text box. Interface options are

- Auto
- PPP
- Ethernet

If there is no response from the server

Retransmit the request after s seconds

The interval between retransmissions of RADIUS packets.

Stop the negotiation after n retransmissions

The maximum number of times RADIUS data should be transmitted to the NAS before the negotiation is deemed to have failed.

Stop the negotiation if there is no activity for s seconds

The inactivity period after which the negotiation procedure is considered a failure.

2. Click **Apply**.

Command line

Command	Instance	Parameter	Values	Equivalent web parameter
radcli	0	ip_ent	Blank,ETH,PPP Blank=Auto	Use Source IP Address
radcli	0, 1	retranint	0-2147483647 Default 5	Retransmit the request after s seconds
radcli	0, 1	retran	0-2147483647 Default 3	Stop the negotiation after n retransmissions
radcli	0, 1	inactto	0-2147483647 Default 30	Stop the negotiation if there is no activity for s seconds

Use TACACS+ to control access to the router

The Digi TransPort range of routers supports Terminal Access Controller Access-Control System Plus (TACACS+) for controlling access to the router.

TACACS+ provides authentication, authorization and accounting (AAA) services. You can use TACACS+ to control the following access methods:

- Secured asynchronous serial (ASY) ports
- Telnet
- SSH
- FTP
- HTTP/HTTPS
- SNMP

When any sort of request is performed by the TACACS+ client, the client first checks to see if a socket to the server (primary or backup) is already open. If a socket is already open, the router uses that socket for the TACACS+ request. If no socket is open, the primary server is tried first. If the primary server socket fails to open, the backup server will be tried. Regardless of whether the primary or backup socket connected, the primary server is always tried first on the next connection attempt. Once the connection to the TACACS+ server opens, all pending requests are sent to the TACACS+ server.

If a connection to the TACACS+ server is not possible due to network or server problems, all requests by applications are denied.

Functions of the AAA services

If TACACS+ authentication is enabled, the request is sent to the TACACS+ server. If disabled, the router performs the authentication. At this point authorization is also performed. If TACACS+ authorization is disabled, the user access level is obtained from the local user table on the router. If TACACS+ authorization is enabled, an authorization request is sent to the TACACS+ server. The server returns a privilege level and may also return other attributed such as a new idle time for this session, which takes precedence over locally configured values.

When the user has been authenticated and access has been authorized, the login is allowed. If the connection is via telnet or SSH, a welcome message showing the access level and the method of authentication is displayed. If the access level was assigned locally the following message is displayed:

```
Welcome. Your access level is SUPER
```

If the access level was assigned by the TACACS+ server, the following message is displayed:

```
Welcome. Your access level is obtained remotely
```

If accounting is enabled, session start and stop messages are sent to the TACACS+ server when the session opens and closes. During the session, details of commands executed and denied due to access level control will be sent to the TACACS+ server. At the end of the session the stop message is sent to the TACACS+ server with the elapsed session time included.

TACACS+ to local privilege level mappings

TACACS+ level	Local level
>= 15	Super
12-14	High
8-11	Medium
4-8	Low
0-3	None

Web

To configure TACACS+ parameters:

1. Go to **Configuration > Security > TACACS+**.
2. Enter TACACS+ parameters:

Primary TACACS+ Server

Hostname or IP address of Server a.b.c.d Port n

The IP address or hostname of the primary TACACS+ server is entered into the left-hand text box. If required a port number may also be specified using the right-hand text box. TACACS+ uses TCP port **49** by default. Entering a different number into this text box will cause the router to use that port instead. The primary and secondary TACACS+ servers use this port number.

Server Key

The encryption key to use when communicating with the primary server.

Confirm Server Key

The key to allow the router to confirm that the two strings are identical.

Secondary TACACS+ Server

Hostname or IP address of Server

The IP address or hostname of the secondary (backup) TACACS+ server. The router uses this value if it cannot open a socket to the primary server.

Server Key

The encryption key to use when communicating with the secondary server.

Confirm Server Key

Enter the key into this text box to allow the router to confirm that the two entries are identical.

Enable local authentication if there is no response from the server(s)

Allows local authentication if TACACS+ authentication fails.

Enable TACACS+ Authentication

Enables authentication. When authentication is enabled, user authentication takes place on the TACACS+ server. When disabled, user authentication takes place locally on the router.

Enable TACACS+ Authorisation

Enables authorization which means that authorization of the application takes place and authorization of application-related commands also takes place.

Enable TACACS+ Accounting

Enables accounting. Sends accounting messages at the start and end of application sessions, where applicable, and update messages from command sessions when commands are denied locally or after they are executed.

3. Click **Apply**.

 **Command line**

Command	Instance	Parameter	Values	Equivalent web parameter
tacplus	0	svr	Up to 64 characters for hostname or valid IP address a.b.c.d	Hostname or IP address of server
tacplus	0	port	0-2147483647 Default 49	Port
tacplus	0	key	Up to 20 characters	Server Key
tacplus	0	svr2	Up to 64 characters or valid IP address a.b.c.d	Hostname or IP address of server
tacplus	0	key2	Up to 20 characters	Server Key
tacplus	0	localauth	off, on	Enable local authentication if there is no response from the server(s)
tacplus	0	authent	off, on	Enable TACACS+ Authentication
tacplus	0	author	off, on	Enable TACACS+ Authorization
tacplus	0	acct	off, on	Enable TACACS+ Accounting

Command	Instance	Parameter	Values	Equivalent web parameter
tacplus	0	debug	off, on	n/a
tacplus	0	tacacspageauth	off, on	n/a

Configure advanced TACACS+ security settings

Advanced TACACS+ parameters do not normally need to be adjusted.

Web

1. Go to **Configuration > Security > TACACS+ > Advanced**.
2. Enter advanced TACACS+ settings as needed:

Use source IP Address x, y

If required because of a TACACS+ server being accessed via a VPN tunnel, you can select an alternative source interface here. Select the required interface from the drop-down list and enter the instance of that interface into the adjacent text box. The available interface options are

- **Auto**
- **PPP**
- **Ethernet**

Response Timeout s seconds

The amount of time, in seconds, before waiting for a response from the TACACS+ server.

Stop the negotiation if there is no activity for s seconds

The amount of time, in seconds, before an inactive socket is closed.

3. Click **Apply**.

Command line

Command	Instance	Parameter	Values	Equivalent web parameter
tacplus	0	ip_ent	Blank,ETH,PPP Blank=Auto	Use source IP Address x,y
tacplus	0	ip_add	0-2147483647	Use source IP Address x,y
tacplus	0	respto	0-2147483647 Default=30	Response Timeout s seconds
tacplus	0	inact	0-2147483647 Default=30	Stop the negotiation if there is no activity for s seconds

Use command filtering

When the command filtering feature is enabled, commands will not reach the router’s command interpreter unless they are defined in the Command Filters table. Terminal devices may send commands that the router will not necessarily understand but that require a basic **OK** or **ERROR** response.

With command filtering turned on, any command entered will be responded to with a MODEM-like **OK** or **ERROR** response (depending on settings below) unless the command is found in the Command Filters table. The command filter uses wild-card character matching so that command filters such as **cmd*** are permitted which would allow all **cmd 0 ...** commands to be executed. Note that the command mapping table is checked first and the command filter table is only checked if there was not a match in the command matching table.

For more information on command filtering, see [Application Note 17: Command Line Response Manipulation](#).

Web

1. Go to **Configuration > Security > Command Filters**.

Command Filters

You can configure up to 20 command filters

Command
No filters have been configured
<input style="width: 80%;" type="text"/> <input type="button" value="Add"/>

Enable Command Filtering on Serial interfaces

Interface	Enable	Return Error
Serial 0	<input type="checkbox"/>	<input type="checkbox"/>
Serial 1	<input type="checkbox"/>	<input type="checkbox"/>
Serial 2	<input type="checkbox"/>	<input type="checkbox"/>
Serial 3	<input type="checkbox"/>	<input type="checkbox"/>
Serial 4	<input type="checkbox"/>	<input type="checkbox"/>
Serial 5	<input type="checkbox"/>	<input type="checkbox"/>
Serial 6	<input type="checkbox"/>	<input type="checkbox"/>
Serial 7	<input type="checkbox"/>	<input type="checkbox"/>
Serial 8	<input type="checkbox"/>	<input type="checkbox"/>
Serial 9	<input type="checkbox"/>	<input type="checkbox"/>
Serial 10	<input type="checkbox"/>	<input type="checkbox"/>

2. In the **Command** field, enter the desired command to filter on into the text box and click **Add**.
3. Once a command is added, you can remove it from the command filtering table by clicking **Delete** next to the command.
4. When you have entered all the commands on which you want to filter, click **Apply**.

Command line

Command	Instance	Parameter	Values	Equivalent web parameter
filter	n	cmd	Valid command line command	Command
cmd	n	cfilton	0, 1 0=Off 1=On	n/a
cmd	n	cfilterr	0, 1 0=Off-OK 1=On-ERROR	n/a

Enable command filtering

To enable command filtering from the command line for any particular instance of the command interpreter, use the following command:

```
cmd <n> cfilton 1
```

The default action is to respond with the **OK** response. If the response needed is **ERROR**, use the parameter:

```
cmd <n> cfilterr 1
```

Where **n** is the instance number.

Note Enclose any blank characters by double quotation marks. When substituting a command, upper case characters are considered the same as the corresponding lowercase characters.

Set calling numbers to answer or reject

Note Only experienced personnel should use this feature for network testing and fault diagnosis. It is not required for normal use. To use this feature, the ISDN circuit must support the Calling Line Identification (CLI) facility. If CLI is supported, incoming calls from specified numbers can be answered normally or rejected with an optional reject code.

Web

1. Go to **Configuration > Security > Calling Numbers**. The **Calling Numbers** page has a table that accepts a series of telephone numbers, each of which has an associated **Answer** or **Reject** parameter, and, for numbers from which calls are to be rejected, a user-defined reason code. For each number set to **Reject**, the router rejects incoming calls from that number using the reason code specified. The reason code is a numeric value chosen to suit the particular application. If any of the entries is set to **Answer**, the router only answers incoming calls from that number and rejects calls from other numbers using a standard ISDN reject code.

▼ Calling Numbers

You can configure up to 10 calling numbers

Number	Mode	Reject Code
No calling numbers have been configured		
<input type="text"/>	Answer ▼	0 <input type="text"/>
<input type="button" value="Add"/>		

Number

The telephone number to either answer or reject.

Mode

The drop-down list in this column selects either **Answer** to answer calls or **Reject** to reject calls.

Reject Code

The reason code pertaining to the rejection of the call.

2. Click **Add** to add the calling number.
3. Click **Apply**.

 **Command line**

Command	Instance	Parameter	Values	Equivalent web parameter
rejlst	n	num	up to 20 digits	Number
rejlst	n	ans	off, on	Mode Answer,Reject
rejlst	n	code	0-255	code

Examples

To display an entry in the calling numbers list enter the command:

```
rejlst <instance> ?
```

where **<instance>** is **0-9**. For example:

```
rejlst 5 ?
```

To set up an entry to reject a number, use the following commands:

```
rejlst 0 num 1234567
rejlst 0 ans OFF
rejlst 0 code 42
```

To set up an entry to answer a number, use the following commands:

```
rejlst 1 num 1234567
rejlst 1 ans ON
```

Configuring telemetry (GPS)

Configure GPS parameters	814
Configure WR31 Cellular GPS	819
Configure GPS support for the GOBI3000 module	821

Configure GPS parameters

Some TransPort router models can connect a GPS receiver the router uses to obtain geographical position information. The GPS module may be internal or external. In either situation, the router uses an internal asynchronous serial (**ASY**) port for the connection. The standard way that GPS modules send the data is using National Marine Electronics Association (NMEA) standard 0183 messages. This protocol is usually simply referred to as NMEA. Routers offering this functionality support the most common NMEA data messages. These messages are described below. GPS receiver modules normally accept configuration commands which specify which of the NMEA messages should be sent to the requesting host.

Web

1. Go to the **Configuration > Telemetry > GPS** page.
2. Configure the GPS parameters:

Set Initial Static GPS position

These settings define initial position for a static TransPort router.

Static Latitude

Defines the latitude component of the router, in degrees.

Static Longitude

Defines the longitude component of the router, in degrees.

Enable local monitoring

Allows messages from the GPS receiver to display on the **Management > Position > GPS** status page. The messages displayed are configured via entries in a table.

GPS Module Initialization String

Some GPS receivers may require configuration via an initialization message at start-up in order to send the appropriate messages in the required format, at the required data rate. Any such required command string is entered into the text entry box and will be sent to the attached GPS receiver module when the router initializes the module.

The table described here controls which NMEA messages should be sent from the module. The default is to enable all messages.

GPS Message List / Include in IP Messages

A list of messages issued by the GPS, and whether to include each GPS message in IP messages.

Fix data (GGA)

The fix data in the selected format (2D, 3D or no fix).

Position (GLL)

The Geographic position (Latitude/Longitude).

Active Satellites (GSA)

The NMEA text containing the number of active satellites for calculating the position.

Satellites in view (GSV)

The NMEA text containing the number of satellites in view.

Position and Time (RMC)

The NMEA text containing the current position and time.

Course over Ground (VTG)

The NMEA text containing the course data.

UTC and local date/time data (ZDA)

Displays the NMEA sentence containing the current local time and date.

All other GPS messages

The above messages are the most common and useful NMEA messages. Many GPS modules support additional messages. Enabling this setting causes the modules to output any other supported messages.

IP Connection 1

The router can send GPS data to up to two IP destinations. These are specified in the following two sections of the web page.

Send GPS messages to IP address a.b.c.d

The IP address to which the GPS data should be sent.

Port n

The required TCP/UDP port number to which the GPS data should be sent.

Every n interval(s)

How often the GPS data is transmitted to the specified host.

- A value of **1** transmits collected GPS data each time a UTC and local date/time data (ZDA) message is received from the GPS receiver module.
- A value of **2** or greater transmits every second message, and so on.

For this feature to work over a TCP/IP connection, you must enable the ZDA message.

Use TCP / UDP

The protocol to use for sending the messages.

Prefix the message with t

A text string that should precede the NMEA data, if desired.

Suffix the message with t

A text string that should follow the NMEA data, if desired.

IP Connection 2

Sends GPS messages to IP address **a.b.c.d**.

Port n

The required TCP/UDP port number to which the GPS data should be sent.

Every n interval(s)

How often the GPS data is transmitted to the specified host.

- A value of **1** causes collected GPS data to be transmitted each time a UTC and local date/time data (ZDA) message is received from the GPS receiver module.
- A value of **2** causes every second message to be sent and so on.

For this feature to work over a TCP/IP connection, the ZDA message must be enabled.

Use TCP / UDP

The protocol to use for sending the messages.

Prefix the message with t

A text string that should precede the NMEA data, if desired.

Suffix the message with t

A text string that should follow the NMEA data, if desired.

3. Click **Apply**.

 **Command line**

gps command

Command	Instance	Parameter	Values	Equivalent web parameter
gps	0	asy_add	The ASY port to which the GPS receiver is connected	n/a
gps	0	gpson	On, Off	Enable local monitoring
gps	0	init_str	Valid command for GPS receiver	GPS Module Initialization string
gps	0	gga_on	0, 1 0=Off 1=On	Fix data (GGA)

Command	Instance	Parameter	Values	Equivalent web parameter
gps	0	gll_on	0, 1 0=Off 1=On	Position (GLL)
gps	0	gsa_on	0, 1 0=Off 1=On	Active Satellites (GSA)
gps	0	gsv_on	0, 1 0=Off 1=On	Satellites in view (GSV)
gps	0	rmc_on	0, 1 0=Off 1=On	Position and time (RMC)
gps	0	vtg_on	0, 1 0=Off 1=On	Course over Ground (VTG)
gps	0	zda_on	0, 1 0=Off 1=On	UTC and local date/time (ZDA)
gps	0	oth_on	0, 1 0=Off 1=On	All other messages
gps	0	IPaddr1	Valid IP address a.b.c.d	Send GPS message to IP address (1)
gps	0	IPport1	Valid IP port n	port n
gps	0	nsecs1	Time s seconds	every n interval(s)
gps	0	udpmode1	0, 1 0=TCP 1=UDP	Use TCP/UDP
gps	0	IPprefix1	Free text	Prefix the message with
gps	0	IPsuffix1	Free text	Suffix the message with
gps	0	IPaddr2	Valid IP address a.b.c.d	Send GPS message to IP address (2)
gps	0	IPport2	Valid IP port n	port n
gps	0	nsecs2	Time s seconds	every n interval(s)
gps	0	udpmode2	0, 1 0=TCP 1=UDP	Use TCP/UDP

Command	Instance	Parameter	Values	Equivalent web parameter
gps	0	IPprefix2	Free text	Prefix the message with
gps	0	IPsuffix2	Free text	Suffix the message with

The following **gps** command parameters are not available on the web interface:

Command	Instance	Parameter	Values	Equivalent web parameter
gps	0	gga_int	s seconds 0-255	n/a
gps	0	gll_int	s seconds 0-255	n/a
gps	0	gsa_int	s seconds 0-255	n/a
gps	0	gsv_int	s seconds 0-255	n/a
gps	0	rmc_int	s seconds 0-255	n/a
gps	0	vtg_int	s seconds 0-255	n/a
gps	0	zda_int	s seconds 0-255	n/a

gpson command

When **gps** is set to **on**, this indicates an instance of the command line interpreter is connected to the GPS receiver. The instance number should be the **ASY** port number to which the GPS receiver is connected. This parameter has two purposes:

- It tells a particular command interpreter instance that it is connected to a GPS receiver so that commands received by that instance should be ignored, rather than being treated as invalid commands.
- The **at\gps** command uses this parameter to determine where the GPS messages originate.

```
cmd <instance> gpson {on|off}
```

at\gps command

- This command causes messages from the GPS receiver to be sent directly to the ASY port from which the command has been entered.
- This requires setting the **gps** parameter to be set to **on** for one of the command interpreter instances.
- As soon as the **at\gps** command has been issued, data from the GPS receiver will be sent to that ASY port.
- To stop the GPS data, enter the **+++** escape sequence, followed by a pause, followed by **at**.

```
at\gps
```

Configure WR31 Cellular GPS

For models of the Digi TransPort WR31 router that include GPS-enabled modems, use this page to configure cellular GPS.

WR31 routers with the following modems include cellular GPS support:

- L9/MC7430—For APAC
- M8/MC7455 – For the rest of the World

Earlier L9 and M8 WR31s that did not include the GPS SMA antenna connector will have these controls, but will not have the ability to connect a GPS antenna.

Web

1. Go to the **Configuration > Telemetry > Cellular GPS** page.
2. Configure the Cellular GPS parameters:

Enable Cellular GPS

By default, cellular GPS is off. To enable cellular GPS:

- a. Select the **Enable Cellular GPS** check box.
- b. Click **Apply**.

Enabling cellular GPS from this page automatically makes the following changes to the **Configuration > Telemetry > GPS** page:

- **Enable local monitoring** is selected.
- The **GPS Module Initialization String** is set to **\$GPS_START**.

For more information about these options, see [Configure GPS parameters](#).

Configure Cellular GPS Antenna Power

By default, the cellular GPS antenna is active, which requires that DC power of 3.3 volts be applied to the antenna. To use a passive GPS antenna, which does not require DC power:

- a. Clear the **Enable Cellular GPS Antenna Power** checkbox.
- b. Click **Apply**.

Command line

cell_gps command

The following options for the **cell_gps** command are used to control the WR31 cellular GPS:

Command	Instance	Parameter	Values	Equivalent web parameter
cell_gps	0	enable	On—Enables cellular GPS. Off (default)—Disables cellular GPS.	Enable Cellular GPS
cell_gps	0	antenna	On (default)—Enables power for an active GPS antenna. Off—Disables power for a passive GPS antenna.	Enable Cellular GPS Antenna

For information about viewing the most recent information received from the GPS module, see [Show GPS data](#).

Configure GPS support for the GOBI3000 module

The GOBI3000 module supports GPS functionality. To configure the GOBI3000 module with GPS functionality:

Command line

Configure the GPS init string with the **\$GPS_START** command:

```
gps 0 init_str $GPS_START
```

Set the **gps asy_add** parameter to **3**.

Managing applications and programs

TransPort routers support loading and running applications in several programming languages.

Manage ScriptBasic applications

Scripting support allows end users to extend and enhance the functionality of the TransPort routers. ScriptBasic is a scripting language supported by Digi TransPort routers. This section describes how to run simple ScriptBasic scripts.

Web

1. Go to **Applications > Basic > ScriptBasic**.
2. Enter ScriptBasic application parameters. The main configuration setting is a table containing a list of reference numbers and associated user parameters. The second setting is a text box containing the name of the script to run. Initially, the table is displayed empty, with a row that states **No parameters have been defined**. The leftmost column contains the number **1**.

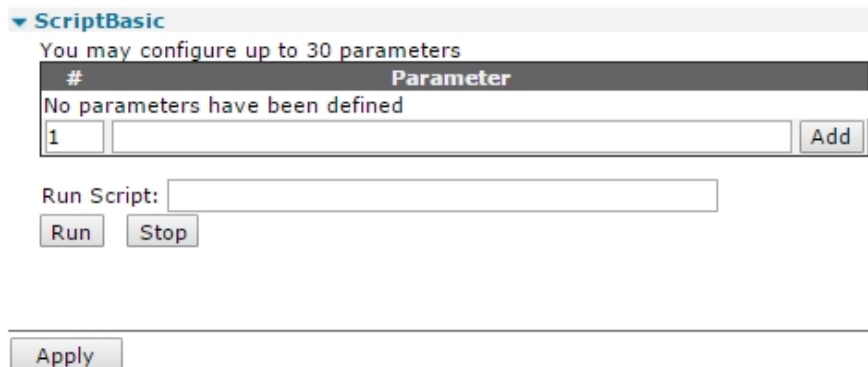

▼ ScriptBasic

You may configure up to 30 parameters

#	Parameter	Add
1		

Run Script:

n

The number of the parameter that appears in the next column. You can configure up to **30** parameters. It is best to enter the numbers in a consecutive, ascending sequence, since this is how the parameters will be referred to in any ScriptBasic script.

Parameter

The name of the parameter to create. This can be any alphanumeric string. Once defined, you can reference these parameters by a ScriptBasic script. For example, a script using parameter **string1** will use the string defined in the text entry box associated with command index **1**.

Add

Adds the parameter to the list of parameters. Parameters are added consecutively, with each parameter number referring to the string in the adjacent column.

Run Script

The name of the ScriptBasic script to run. This script must exist in the router’s file system. Typically, ScriptBasic scripts use the **.sb** file extension, such as **myscript.sb**.

Run

Runs the named ScriptBasic script.

Stop

Stops the execution of the ScriptBasic script.

3. Click **Apply**.

 **Command line**

Command	Instance	Parameter	Values	Equivalent web parameter
basic	0	string1-string30	Free-form alphanumeric text	Parameter
basic	0	n/a	kill	Stop
bas	n/a	n/a	Name of ScriptBasic script	Run Script

Examples

To set user parameter **1** to IPv4 address **10.1.1.1**, enter:

```
basic 0 string1 10.1.1.1
```

To execute a script, enter:

```
bas <myscript.sb>
```

To kill a running script, enter:

```
Basic 0 kill
```

Manage Python applications

Some Digi TransPort routers support the Python scripting language. Python allows you to extend and enhance the basic functionality of the router through programming. The routers contain a Python interpreter you can invoke from the command line. This is useful for developing scripts. The more usual way to use Python is to write a script to implement a required function and to run this script autonomously. It is common practice for Python scripts to use the file extension **.py**, such as **myscript.py**. A Python script is a text file containing Python commands and may be created using a normal plain text editor. Python is a powerful language and obtains some of its power from the many modules that are available for it. A description of the Python language is outside the scope of this manual. For more information on Python programming see the [Digi Python Programmer's Guide](http://www.digi.com) on www.digi.com.



CAUTION! Avoid writing Python scripts, or taking any other kind of actions, that perform frequent flash writing. NAND flash typically accommodates a limited number of writes, up to **100,000**. Exceeding this limit can cause device failure.

Web

1. Go to **Applications > Python > Python Files**.

[Applications - Python > Python Files](#)

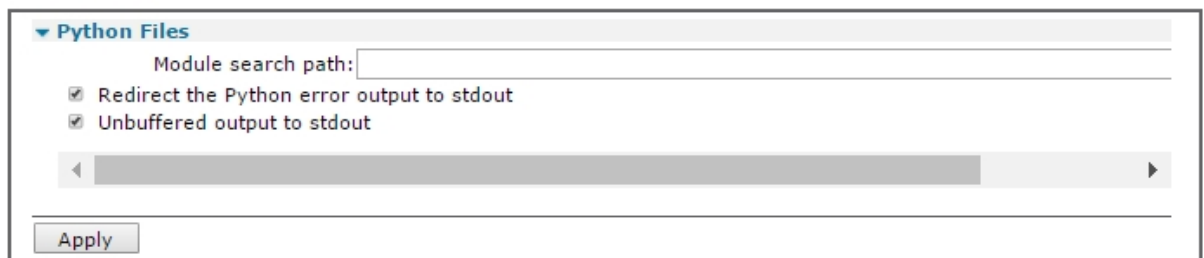

2. Enter the Python file management settings as needed:

Module search path

The search path for Python modules that are not in the default search path. Specify multiple locations by separating pathnames with colons, such as **pymod1.zip:python21.zip**. This causes the interpreter to search for two compressed files **pymod1.zip** and **python21.zip**. TransPort routers have a flat filing system structure that does not support subdirectories.

Redirect the Python output to debug

Allows the redirection of the **stdout** file handle to the debug output (**stderr**) file handle. The default for this parameter is **Off**. The easiest way to see this redirection in action is to issue the command to start the Python interpreter from a debug/CLI terminal. Note that the screen remains blank. Stop the interpreter (using the **exit()** command), set this parameter to **On**, and re-issue the command to start the interpreter. This time, the familiar Python welcome message and prompt should appear on the console.

Unbuffered output to stdout

Redirects unbuffered output to file handle to the debug output (**stderr**) file handle.

3. Click **Apply**.

Command line

Command	Instance	Parameter	Values	Equivalent web parameter
pycfg	0	modpath	valid search path, such as mymod.py	Module search path
pycfg	0	stderr2stdout	0, 1 0=Off 1=On	Redirect the Python output to debug

The following informational/debugging commands are helpful when developing Python scripts:

- **pycfg files:** Displays the status of any Python files.
- **pycfg mem:** Shows the memory usage for the router.
- **pycfg scripts:** Shows the status of any scripts and change count.

Managing networks and connections

There are several web pages and commands for viewing network status and managing connections for your TransPort router.

Show network interface status

You can view the current status and statistics for various interfaces from the web interface and command line.

Show Ethernet status and statistics

Web

Go to **Management > Network Status > Interfaces > Ethernet > ETH n**.

The **ETH n** page displays the current status and statistics of the selected Ethernet interface.

[Management - Network Status](#) > [Interfaces](#) > [Ethernet](#) > [ETH 0](#)

▼ Interfaces

 Ethernet

 ▼ ETH 0

 IP Address: 10.10.14.21

 Mask: 255.255.255.0

 DNS Server: 10.10.8.62

 Secondary DNS Server: 10.10.8.64

 Gateway: 10.10.14.1

 MAC Address: 00:04:2D:04:B4:4D

 Speed: 100 Mbps

 Duplex: Full

 Bytes Received: 1010862039

 Bytes Sent: 250538913

 Packets Received: 49934691

 Packets Sent: 2378907

 Rx Overruns: 0

 Collisions: 0

 Flood Protection: (Currently Off)

 Alignment Errors: 0

 Late Collisions: 0

 FCS Errors: 0

 Tx Deferred: 0

 Long Frames: 0

 Carrier Sense Errors: 0

 Rx MAC Errors: 0

 Tx MAC Errors: 0

 Other Errors: 0

Refresh Clear Stats

IP Address

The IP address of the Ethernet interface, which is either manually configured or assigned via DHCP.

Mask

The mask of the Ethernet interface, which is either manually configured or assigned via DHCP.

DNS Server / Secondary DNS Server

The primary and secondary DNS Server IP addresses of the Ethernet interface, which are either manually configured or assigned via DHCP.

Gateway

The IP gateway of the Ethernet interface, which is either manually configured or assigned via DHCP.

MAC Address

The Ethernet interface's MAC address.

Speed

The current speed of the Ethernet interface.

Duplex

The current duplex mode of the Ethernet interface.

Bytes Received

The number of bytes received on the Ethernet interface.

Bytes Sent

The number of bytes sent on the Ethernet interface.

Packets Received

The number of packets received on the Ethernet interface.

Packets Sent

The number of packets sent on the Ethernet interface.

Unicast Packets Received

The number of unicast packets received on the Ethernet interface.

Unicast Packets Sent

The number of unicast packets sent on the Ethernet interface.

Broadcast Packets Received

The number of broadcast packets received on the Ethernet interface.

Broadcast Packets Sent

The number of broadcast packets sent on the Ethernet interface.

Multicast Packets Received

The number of multicast packets received on the Ethernet interface.

Multicast Packets Sent

The number of multicast packets sent on the Ethernet interface.

Rx Overruns

The number of receive overruns that have occurred on the Ethernet interface. An Rx overrun occurs when there are not enough buffers to receive incoming packets which results in the received packets being dropped.

Collisions

The number of times the router has detected a packet collision on the Ethernet network when transmitting a packet.

Late Collisions

The number of times the router has detected a late packet collision on the Ethernet network when transmitting a packet.

Flood Protection

The number of times the router has detected an Ethernet packet flood on the network and has enabled the Flood Protection mechanism. Flood protection is designed to stop the router from being overwhelmed by the sudden large increase in packets on the Ethernet network.

Alignment Errors

The number of alignment errors that have been detected when receiving an Ethernet packet.

FCS Errors

The number of Ethernet packets that have been received but had an invalid FCS.

Tx Deferred

The Ethernet packets successfully transmitted after being initially deferred.

Long Frames

The number of Ethernet packets that have been received which are too long.

Carrier Sense Error

The number of carrier sense errors that have occurred. These errors occur when the router attempts to transmit an Ethernet packet but cannot detect the carrier sense condition on the Ethernet network.

Rx MAC Errors

The number of internal errors that have occurred when receiving an Ethernet packet.

Tx MAC Errors

The number of internal errors that have occurred when attempting to transmit an Ethernet packet.

Other Errors

The number of errors that have occurred that are not counted by the other statistics.

 **Command line**

Command	Instance	Parameter	Action
eth	n	status	Displays the current configuration and status of Ethernet interface n.
ethstat	n	n/a	Displays the statistics for Ethernet interface n.
at\mibclr=eth.n.stats	n/a	n/a	Clears the statistics for Ethernet interface n.

Show Wi-Fi status and statistics

Web

Go to **Management > Network Status > Interfaces > WiFi > WiFi n**.

Module Detected

Indicates that the Wi-Fi hardware has been detected by the router.

Admin Status

The current administrative state of the Wi-Fi interface. It indicates whether there is sufficient configuration to bring the Wi-Fi interface up. It can be either **Up** or **Down**.

Operational Status

The current operational state of the Wi-Fi interface. It can be either **Up** or **Down**.

Channel Mode

The Wi-Fi channel mode in use. The possible values for this parameter are **A, A/N, A/N/AC, B/G, B/G/N**.

Channel

The Wi-Fi channel in use.

Bytes Received

The number of bytes received on the Wi-Fi interface.

Bytes Sent

The number of bytes sent on the Wi-Fi interface.

Packets Received

The number of packets received on the Wi-Fi interface.

Packets Sent

The number of packets sent on the Wi-Fi interface.

Receive Errors

The number of receives errors that have occurred on the Wi-Fi interface.

Transmit Errors

The number of transmit errors that have occurred on the Wi-Fi interface.

Received Packets Dropped

The number of received packets that have been dropped on the Wi-Fi interface.

Wi-Fi Client Connections table

The **Wi-Fi Client Connections** table gives information on the Wi-Fi clients that are connected to the router's Wi-Fi Access Point interface.

Number of Connected Wi-Fi Clients: 2

Node	Wi-Fi Node	RSSI	Flags	Power Save	Mode	Neg. Rates (Mbps)	TX Rate (Mbps)	RX Rate (Mbps)	Capability Info
18:3D:A2:6E:78:BC	0	46	ERP,	Awake	N	6.5, 13.0, 19.5, 26.0, 39.0, 52.0, 58.5, 65.0, 13.0, 26.0, 39.0, 52.0, 78.0, 104.0, 117.0, 130.0	19.5	2.0	ESS, Privacy, Short Preamble, Short Slottime, <input type="button" value="Disconnect"/>
E0:9D:31:6A:D7:A0	0	51	ERP,	Sleep	N	6.5, 13.0, 19.5, 26.0, 39.0, 52.0, 58.5, 65.0, 13.0, 26.0, 39.0, 52.0, 78.0, 104.0, 117.0, 130.0	6.5	6.0	ESS, Privacy, Short Preamble, Short Slottime, <input type="button" value="Disconnect"/>

Node

The MAC address of the connected Wi-Fi client.

Wi-Fi Node

The Wi-Fi node on the router the client is connected to.

RSSI

The signal strength experienced by the Wi-Fi client.

Flags

The state information for the Wi-Fi client connection.

Power Save

The current power saving state of the Wi-Fi client. The possible values are **Awake** and **Sleep**.

Neg. Rates (Mbps)

The transmission rates that have been negotiated with the Wi-Fi client.

Capability Info

The capabilities the router has advertised to the Wi-Fi client.

Access Point Connections Table

This **Access Point Connections** table gives information on the Wi-Fi Access Points to which the router is connected.

Number of Access Point Connections: 1

Access Point	Wi-Fi Node	RSSI	Flags	Power Save	Neg. Rates (Mbps)	Capability Info
JPHOME (00:18:4d:67:c5:c8)	0	28	-	Awake	1.0, 2.0, 5.5, 6.0, 9.0, 11.0, 12.0, 18.0, 24.0, 36.0, 48.0, 54.0	ESS, Privacy, <input type="button" value="Disconnect"/>

Access Point

The name and MAC address of the Wi-Fi Access Point that the router is connected to.

Wi-Fi Node

The Wi-Fi node that for connecting to the Access Point.

RSSI

The signal strength experienced by the router when connected to the Wi-Fi Access Point.

Flags

The state information for the Wi-Fi Access Point connection.

Power Save

The current power saving state of the router. The possible values are **Awake** and **Sleep**.

Neg. Rates (Mbps)

The transmission rates that have been negotiated with the Wi-Fi Access Point.

Capability Info

The capabilities of the Access Point to which the router is connected.

Disconnect

Disconnects the specified client device.

Disconnect All Clients

Disconnects all client devices.

 **Command line**

Command	Options	Parameter	Equivalent web parameter
wificonn	n/a		Displays the Wi-Fi connection table.
wificonn	x	cscan	Performs wifi network scan
wifistat	n/a		Displays the Wi-Fi statistics.

Show mobile status and statistics

Web

Go to **Management > Network Status > Interfaces > Mobile**.

The **Mobile** status page displays the current mobile connection, network and module information.

[Management - Network Status > Interfaces > Mobile](#)

Mobile

The following information and statistics can be used to manage and monitor your mobile connection. This information may also be helpful in troubleshooting problems with the mobile network.

Mobile Connection

Registration Status: 1 (registered) tac:BE43 ci:02E90520
 Signal Strength: Fair (-107 dBm)
 Signal Quality: Excellent (-8 dB)
 Connection type: NDIS

Mobile Statistics

IP Address: 100.70.166.27
 Primary DNS Address: 198.224.149.135
 Secondary DNS Address: 198.224.148.135
 Data Received: 5.91 KB
 Data Sent: 7.89 KB

Mobile Information

Results of Last Module Status Poll at 30 May 2017 21:38:43
 Outcome: Got modem status OK

SIM status: Ready (PIN checking disabled)
 Signal strength: -79 dBm
 Radio technology: LTE
 Signal quality (LTE): RSSI -79 dBm, RSRP -107 dBm, RSRQ -8 dB, SINR 5.0 dB
 Radio band: E-UTRA Operating Band 4
 Channel: 2050
 Manufacturer: QUALCOMM INCORPORATED
 Model: LE910-SVG
 IMEI: 353238060001558
 ESN: 80250918
 IMSI: 311480210983654
 MDN: 6122485442
 ICCID: 89148000002090256071
 Firmware: 17.01.571 1 [Oct 16 2014 07:00:00]
 Hardware version: 30000
 APN in use: Context 3: VZWINTERNET
 Attachment status: Attached
 Registration State: 1 (registered) tac:BE43 ci:02E90520
 Network: V??, 311480
 Preferred system: Auto
 Network Technology: LTE
 Temperature: 37C

Refresh

Scan for networks

Unlock networks

Note: any network lock/unlock actions only take effect after next data disconnect/reconnect

Mobile Connection status

Registration Status

The GSM registration status of the mobile module with respect to the GSM network. It may be one of the following

- Not Registered, not searching
- Not registered, searching
- Registered, home network
- Registered, roaming
- Registration denied
- Unknown
- ERROR

The registration status may sometimes be followed by additional information about the **Location Area Code (LAC)** and the **Cell Identifier (CI)**.

Signal Strength

The signal strength in dBm being received by the mobile module. The range is **-113dBm** (min) to **-51dBm** (max). The signal strength bars should match the **Signal Strength LEDs** on the front of the router.

Signal Quality

A measure of the signal level of the cellular network, measured in dB.

Connection type

Cellular connection type.

Mobile Statistics

IP Address

The IP address of the mobile interface.

Primary DNS Address / Secondary DNS Address

The primary and secondary DNS addresses the mobile interface uses.

Data Received

The number of data bytes received on the mobile interface while it has been connected.

Data Sent

The number of data bytes sent on the mobile interface while it has been connected.

Mobile Information

The information in this section varies by cellular module type.

GSM networks

For GSM networks, the Mobile Information section can have the following items.

SIM Status

This indicates whether or not a valid SIM card has been installed in the router. It may be one of the following

- **READY:** SIM is OK.
- **SIM PIN:** PIN number required.
- **SIM PUK:** SIM blocked (unblocking code required).
- **ERROR:** SIM is not installed or is faulty.

Signal strength

The signal strength in dBm being received by the mobile module. The range is **-113dBm** (min) to **-51dBm** (max). The signal strength bars should match the **Signal Strength LEDs** on the front of the router.

Radio technology

The current network technology in use. It may be one of the following

- GSM
- GPRS
- EDGE
- UMTS
- HSDPA
- HSUPA
- CDMA

Signal quality

A measure of the signal level of the cellular network, measured in dB.

Radio band

The radio band on which the cellular modem is operating.

Channel

The radio channel on which the cellular modem is operating.

Manufacturer

The manufacturer of the mobile module.

Model

The model of the mobile module.

IMEI

The International Mobile Equipment Identification (IMEI) of the mobile module.

ESN

The Electronic Serial Number (ESN) of the mobile module.

MEID

The Mobile Equipment Identifier (MEID) of the mobile module.

IMSI

The International Mobile Subscriber Identity (IMSI) of the mobile module.

ICCID

This field specifies Integrated Circuit Card Identifier (ICCID) of the SIM card.

Firmware

This specifies firmware running on mobile module.

Bootcode

This field specifies bootcode firmware running on the mobile module.

Hardware version

The hardware version of the mobile module.

GPRS Attachment Status

The current status of the mobile module with respect to the Mobile service. It may be one of the following

- **Not attached:** The router has not connected to a mobile service.
- **Attached:** The router has connector to a mobile service.
- **ERROR:** Unknown response from the mobile module.

GPRS Registration

See the **Registration Status** description.

APN in use

The Access Point Name (APN) for the cellular interface being used by the cellular module.

Network

The name of the GSM network to which the mobile module is currently connected to or ERROR if no network is available.

Preferred system

The preferred technology. It can be one of following:

- Auto
- GSM only
- WCDMA only

CDMA networks

For CDMA networks, the Mobile Information can have the following items.

Network

The current network reported by the mobile module.

Signal strength 1xRTT

The signal strength in dBm being received by the mobile module from 1xRTT networks.

Signal strength EVDO

The signal strength in dBm being received by the mobile module from EVDO networks.

Manufacturer

The manufacturer of the mobile module.

Model

The model of the mobile module.

MDN

The Mobile Directory Number (MDN) of the mobile module.

MIN

The Mobile Identification Number (MIN) of the mobile module.

ESN

The Electronic Serial Number (ESN) of the mobile module.

MEID

The Mobile Equipment Identifier (MEID) of the mobile module.

Firmware

The firmware running on mobile module.

Bootcode

The bootcode firmware running on the mobile module.

Hardware version

The hardware version of the mobile module.

Registration State

See the **Registration Status** field.

Roaming status

The current roaming status of the mobile module.

Radio interfaces in use

Can be one of the following

- CDMA 1x
- EVDO
- No service
- Unknown

PRL version

The version of the Preferred Roaming List (PRL) loaded on the mobile module.

Activation status

The activation state of the mobile module. It can be of the following:

- 0-Not activated
- 1-Activated

**Command line**

Command	Option	Action
modemstat	?	Displays mobile status information.
modemstat	s	Scans for networks.
pppstat	n	Displays mobile statistics (where n is the PPP interface the mobile interface uses)
at\mibs=ppp.n.stats	n	Displays the current interface statistics.
at\mibclr=ppp.n.stats	n	Clears the current interface statistics.

Show DSL status and statistics

Web

Go to **Management > Network Status > Interfaces > DSL**. The **DSL** status page displays the current status and statistics of the DSL interface.

▼ DSL

Modem Status: Up
 Link Uptime: 0 Hrs 0 Mins 10 Secs
 Firmware Version: 2227:0
 Operational Mode: G.dmt Annex A
 Remote Vendor ID: TSTC

	Downstream	Upstream
Speed (kbps):	7808	832
Channel:	Interleave	Interleave
Relative Capacity (%):	87	71
Attenuation (dB):	29.0	13.0
Noise Margin (dB):	16.5	11.0
Output Power (dBm):	15.5	12.5
Indicator Bits:	0x0000	0x0000
Cells:	7	9
CRC:	1	0
HEC:	0	0
LOS:	0	0
SEF:	0	0
Corrected Blocks:	0	
Uncorrected Blocks:	0	
Overrun Cells:	0	
Idle Cells:	0	

Refresh
Clear Stats

Modem Status

The current status of the DSL modem. On the DR64 platform, the values can be one of the following:

- Idle
- Activating
- Ghs
- Training
- Up

Link Uptime

The amount of time the modem has been in the **Up** state.

Firmware Version

The version of the firmware running on DSL modem.

Operational Mode

The operational mode that the DSL modem is in when in the Up state. It is in the format of:

```
<Mode> Annex <A | B | M>
```

where the **<Mode>** can be one the following:

- ANSI
- ETSI
- G.dmt
- G.lite
- ADSL2
- ADSL2+

Remote Vendor ID

The remote vendor ID of the DSLAM that the DSL interface connected to.

Speed

The current speed the downstream and upstream DSL channels in Kbps.

Channel

The channel type in use. It can be either **Fast** or **Interleaved**.

Relative Capacity

The current relative capacity on the downstream and upstream DSL channels. The relative capacity is the percentage of your overall available bandwidth for obtaining your ATM service rate.

Attenuation

The current attenuation, in decibels, on the downstream and upstream DSL channels. Attenuation is the measure of how much the signal has degraded between the DSLAM and the DSL modem. The lower the attenuation, the better the performance will be.

Noise Margin

The current noise margin, in decibels, on the downstream and upstream DSL channels. The noise margin (aka Signal to Noise Ratio) is the relative strength of the DSL signal to noise. The larger the noise margin, the better the performance will do. In some instances, interleaving can help raise the noise margin.

Power Output

The current amount of power, in dBm, that the DSL modem (upstream) and DSLAM (downstream) are using. The lower the power output, the better the performance.

Indicator Bits

The indicator bit values in use on the downstream and upstream DSL channels.

Cells

The number of cells that have received (downstream) and transmitted (upstream).

CRC

The number of CRC errors that have occurred downstream and upstream.

HEC

The number of Header Error Controls (HEC) errors that have occurred downstream and upstream.

LOS

The number of Loss of Signal (LOS) errors that have occurred downstream and upstream.

SEF

The number of Severely Errored Frame (SEF) errors that have occurred downstream and upstream.

Corrected Blocks

The number of blocks received and corrected by the forward error correction (FEC) code.

Uncorrected Blocks

The number of blocks that were received and could not be corrected by the forward error correction (FEC) code.

Overrun Cells

The number of cells lost because of overrun errors.

Idle Cells

The number of idle cells received.



Command line

Command	Instance	Action
adslst	n/a	Displays the current DSL interface status.
at\mibs=adsl.0.stats	n/a	Displays the current DSL interface statistics.
at\mibclr=adsl.0.stats	n/a	Clears DSL statistics. Performs the equivalent of the web interface Clear Stats button
pppstat	n	Displays DSL statistics, where n is the PPP interface the DSL PVC is using.

Show GRE interface status

Web

Go to **Management > Network Status > Interfaces > GRE**. The **GRE** page displays a summary table of the configured GRE interfaces.

▼ GRE

#	Description	Oper. Status	IP Address	Mask	Source	Destination
0	Paris Office	Up	47.1.2.3	255.255.255.0	ETH 0 (10.1.47.30)	47.47.1.2
1	New York Office	Up	47.2.2.2	255.255.255.0	10.1.47.30	192.168.44.3

Refresh

#

The GRE interface number.

Description

The configured GRE interface description.

Oper. Status

The current operational status of the GRE interface. It can be one of the following values:

- **Up:** The GRE interface is up.
- **Lower Layer Down:** The GRE interface has keepalives enabled, but is not getting any response from the configured destination.

IP Address

The configured IP address for the GRE interface.

Mask

The configured IP subnet mask for the GRE interface.

Source

The configured source IP address or interface of the GRE interface.

Destination

The configured destination IP address or domain name of the GRE interface. Further information on particular GRE interfaces can be obtained by selecting the appropriate GRE interface submenu underneath the GRE summary table.

The following statistics are also displayed:

Bytes Received

The number of bytes received on the GRE interface.

Bytes Sent

The number of bytes sent on the GRE interface.

Packets Received

The number of packets received on the GRE interface.

Packets Sent

The number of packets sent on the GRE interface.

Keepalives Received

The number of GRE keepalive packets received on the GRE interface.

Keepalives Sent

The number of GRE keepalive packets sent on the GRE interface.

Rx Errors

The number of receive errors that have occurred on the GRE interface. These can include the received being an invalid GRE packet.

Tx Errors

The number of transmit errors that have occurred on the GRE interface. These can include an internal error due to no packet buffers being available.

Rx Unknown

The number of packets that have been received with an unknown IP protocol and have been dropped.

Tx Discards

The number of packets that have been discarded during transmission due to the GRE interface not being up or if a routing loop has been detected.

**Command line**

Command	Instance	Options	Action
tunstat	n	n/a	Displays the GRE interface specific status and statistics.
tunstat	n	clear	Clears the statistics for the GRE interface.

Show ISDN status and statistics

Web

Go to **Management > Network Status > Interfaces > ISDN**.

The ISDN parameters section contains the status information for the ISDN interface.

ISDN BRI

The status information is presented as a simple table having three or four columns as described below:

Channel

There are three supported channels; the D-channel, B1, and B2 channels that appear in this column. Each channel row has an associated status, protocol and (for data channels) action. The **Action** column will only appear when the associated channel becomes active.

Status

The status of each channel. The status is either **ON** or **OFF**.

Protocol

The protocol in use by the channel. This should be as set up in the configuration procedure. For D-channels, this will be **LAPD**. If the associated channel is not active, this entry will be blank.

Action

When the link becomes active, a button should appear in this column. The text on the button will be **Drop Link**. Clicking the button deactivates the channel.

Command line

If a PPP instance has been associated with a B-channel, display the statistics for that PPP instance using the normal **pppstat** command.

Show PSTN interface status and statistics

Web

Go to **Management > Network Status > Interfaces > ISDN**.

The **PTSN** section contains the network status information for the PSTN interface.

Link Name

A description of the interface, if one was assigned during the configuration.

This PSTN interface is using PPP n

When configuring the PSTN module, a PPP instance is assigned. This field is the instance number of the assigned PPP interface.

IP Address

The IP address assigned to the interface.

Mask

The subnet mask in use by the interface.

DNS Server

The IP address of the DNS server in use by the interface.

Bytes Received

The number of bytes received by the interface.

Bytes Sent

The number of bytes sent by the interface.

LCP Packets Received

The number of Link Control Protocol (LCP) packets received.

LCP Packets Sent

The number of LCP packets sent by the interface.

PAP Packets Received

The number of Password Authentication Protocol (PAP) packets sent by the interface.

PAP Packets Sent

The number of PAP packets sent by the interface.

IPCP Packets Received

The number of IP Control Protocol (IPCP) packets received by the interface.

IPCP Packets Sent

The number of IPCP packets sent by the interface.

Receive Errors

The number of frames received that contain an error (CRC etc).

Transmit Errors

The number of frames the interface attempted to transmit, but were found to contain an error.

Refresh

Updates the statistics on the page.

Clear PPP n Statistics

Reset the statistics to **0**.

**Command line**

The command to display the PPP status is:

```
pppstat <n>
```

where **<n>** is the interface number for the PPP interface assigned to the PSTN module and is shown at the top of the web page. For descriptions of the pppstat output, see [Show PPP status and statistics](#).

Show serial status and statistics

Web

Go to **Management > Network Status > Interfaces > Serial > Serial n.**

The **Serial** page displays the current status and statistics of the selected serial interface.

Serial			
Serial 0			
DTR:	Off		
Bytes Received:	170	Bytes Sent:	445
Rx Overruns:	0	Tx Underruns:	0
Breaks Received:	0	Tx Errors:	0
Framing Errors Received:	0	Tx Timeouts:	0
Parity Errors Received:	0		
Buffer Shortages:	0		
Message Shortages:	0		

Refresh Clear Stats

DTR

The current status of the Data Terminal Ready (DTR) signal.

Bytes Received

The number of bytes received on the serial interface.

Rx Overruns

The number of receive overruns that have occurred on the serial interface. A receive overrun occurs when there are not enough buffers to receive incoming data, resulting in dropping the received data being dropped.

Tx Underruns

The number of transmit underruns that have occurred on the serial interface. A transmit underrun occurs when there is not enough data available when it is about to be transmitted.

Breaks Received

The number of times a break signal has been received.

Framing Errors Received

The number of framing errors detected when receiving data on the serial interface.

Parity Errors Received

The number of parity errors detected when receiving data on the serial interface.

Buffer Shortages

The number of times data received on the serial interface was dropped because of a lack of system buffers.

Message Shortages

The number of times data received on the serial interface was dropped because of a lack of system messages.

**Command line**

Command	Instance	Parameter	Action
at\ <code>\mibs=asy.n</code>	n/a	n/a	Displays the statistics for serial interface n.
at\ <code>\mibclr=asy.n</code>	n/a	n/a	Clears the statistics for serial interface n.

Show PPP status and statistics

Web

Go to **Management > Network Status > Interfaces > Advanced > PPP > PPP n**.

The **PPP n** page displays the current status and statistics of the selected PPP interface.

▼ PPP 1 - W-WAN (LTE)

Uptime: 0 Hrs 39 Mins 33 Seconds

Option	Local	Remote
MRU:	1500	1500
ACCM:	0x0	0xffffffff
VJ Compression:	ON. 1 slots	OFF
Link Active With Entity: USBHOST 0		
IP Address: 100.107.165.53		
DNS Server IP Address: 198.224.149.135		
Secondary DNS Server IP Address: 198.224.148.135		
Outgoing Call To: *98*1#		

Total Data Transferred: 14144	Total Up Time Today (mins): 1082
Bytes Received: 6058	Bytes Sent: 8086
LCP Packets Received: 128	LCP Packets Sent: 128
PAP Packets Received: 44	PAP Packets Sent: 44
IPCP Packets Received: 68	IPCP Packets Sent: 117
BACP Packets Received: 0	BACP Packets Sent: 0
BAP Packets Received: 0	BAP Packets Sent: 0
Unknown Packets Received: 0	
Receive Errors: 0	Transmit Errors: 0
CRC Errors Received: 0	Framing Errors Received: 0

Raise Link

Activates the PPP interface.

Drop Link

Deactivates the PPP interface.

Note The PPP interface remains deactivated until you click the **Raise Link** button.

Name

The name assigned to the PPP interface.

Uptime

The amount of time the PPP interface has been up.

MRU

The maximum receive unit (MRU) that has been negotiated by each peer on the PPP connection.

ACCM

The Asynchronous Control Character Map (ACCM) that has been negotiated by each peer on the PPP connection.

VJ Compression

The Van Jacobson (VJ) compression that has been negotiated by each peer on the PPP connection.

Link with Active Entity

The entity this PPP interface is using for connectivity.

IP Address

The IP address assigned to this PPP interface. This could be either statically configured or assigned by the remote PPP peer.

DNS Server IP Address / Secondary DNS Server IP Address

The primary and secondary DNS server IP addresses the PPP interface is using.

Outgoing Call To

If this is dial-out PPP interface, this is the number for making the call.

Total Data Transferred

The total amount of data bytes received and transmitted on the PPP interface, including PPP headers and payload.

Total Up Time Today

The total amount of time, in minutes, the PPP interface has been connected in the current 24-hour period.

Bytes Received

The number of bytes received on the PPP interface.

Bytes Sent

The number of bytes sent on the PPP interface.

LCP Packets Received

The number of Link Control Protocol (LCP) packets received on the PPP interface.

LCP Packets Sent

The number of Link Control Protocol (LCP) packets sent on the PPP interface.

PAP Packets Received

The number of Password Authentication Protocol (PAP) packets received on the PPP interface.

PAP Packets Sent

The number of Password Authentication Protocol (PAP) packets sent on the PPP interface.

IPCP Packets Received

The number of IP Control Protocol (IPCP) packets received on the PPP interface.

IPCP Packets Sent

The number of IP Control Protocol (IPCP) packets sent on the PPP interface.

BACP Packets Received

The number of Bandwidth Allocation Control Protocol (BACP) packets received on the PPP interface.

BACP Packets Sent

The number of Bandwidth Allocation Control Protocol (BACP) packets sent on the PPP interface.

BAP Packets Received

The number of Bandwidth Allocation Protocol (BAP) packets received on the PPP interface.

BAP Packets Sent

The number of Bandwidth Allocation Protocol (BAP) packets sent on the PPP interface.

Unknown Packets Received

The number of packets received with an unknown or unsupported PPP protocol.

Receive Errors

The number of receive errors that have occurred on the PPP interface.

Transmit Errors

The number of transmit errors that have occurred on the PPP interface.

CRC Errors Received

The number of packets received on the PPP interface with invalid CRCs.

Framing Errors Received

The number of packets received on the PPP interface with invalid framing.

Transaction Statistics**Last Counter Reset Timestamp**

The time when the PPP transaction statistics were last reset.

Successful Transaction Count

The number of successful PPP transactions.

Dropped Transaction Count

The number of transactions sent but no response has been received.

Minimum Transaction Time

The shortest response time, in milliseconds, for a PPP transaction.

Maximum Transaction Time

The longest response time, in milliseconds, for a PPP transaction.

Average Transaction Time

The average response time, in milliseconds, for the successful PPP transactions.

Route OOS Count

The number of Route **Out Of Service** messages sent by the firewall to the routing code. These messages put routes out of service for a period of time and are sent when enough failed PPP transactions have occurred.

 **Command line**

Command	Instance	Parameter	Action
ppp	n	act_rq	Raises the PPP link.
ppp	n	deact_rq	Drops the PPP link.
ppp	n	status	Displays the current status of PPP interface n .
at\mibs=ppp.n.stats	n/a	n/a	Displays the statistics for PPP interface n .
at\mibclr=ppp.n.stats	n/a	n/a	Clears statistics for PPP interface n

Show IP statistics

Web

Go to **Management > Network Status > IP Statistics**.

Bytes Received

Number of bytes received.

Bytes Sent

Number of bytes sent.

Packets Received

Number of packets received.

Packets Sent

Number of packets sent.

Multicast Packets Received

Number of multicast packets received.

Multicast Packets Sent

Number of multicast packets sent.

Bytes Routed

Number of bytes that have passed through the routing table.

Packets Routed

Number of packets that have passed through the routing table.

Bytes NATed

Number of outgoing bytes that have passed through the Network Address Table (NAT) code.

Packets NATed

Number of outgoing packets that have passed through the NAT code.

Packets Filtered

The number of packets filtered by the filter rule set during the most recent collection interval.

TCP Retransmits

Number of TCP retransmits generated by local TCP sockets.

No Route

Number of received packets that have no routing information associated with them.

Failed to Route

Number of packets that have been routed to a route that is unavailable or out of service.

Packet Timeouts

Number of packets that have been dropped due to TTL reaching **0**.

NAT Shortages

Number of times the pool of NAT entries has been exhausted. When this happens, the entry that has been used least recently is used.

Checksum Errors

Number of packets that have not passed the checksum check.

Discards

Number of packets dropped for miscellaneous reasons.



Command line

Use the **ipstat** command.

Show the IP routing table

Web

Go to **Management > Network Status > IP Routing Table**.

The **IP Routing Table** page displays the IPv4 routing table.

▼ IP Routing Table

Destination	Gateway	Metric	Protocol	Idx	Interface	Status
10.10.14.0/24	10.10.14.21	1	Local	-	ETH 0	UP
100.70.166.24/29	100.70.166.27	1	Local	-	PPP 1	UP

Default Routes

Destination	Gateway	Metric	Protocol	Idx	Interface	Status
0.0.0.0/0	10.10.14.1	2	Static	0	ETH 0	UP

Refresh Toggle Src Addr

Destination

The destination IP network of the route. To use the route, the destination must match the destination IP address of an IP packet. For default routes, the destination IP network is always **0.0.0.0/0**. The router uses default routes when no other route matches the destination IP address of an IP packet.

Src Addr

When source address routing in use, to use the route, the **Src Addr** value must match the source IP address of an IP packet.

Gateway

The IP address of the next router to which the IP packet will be routed to reach the destination network. On **PPP** and **TUN** interfaces, and **ETH** interfaces that have the gateway configured, this parameter can be blank.

Metric

The route metric defines the cost of the route. If CIDR routing is enabled and there are two routes to the same destination, the router uses the route with the lower metric.

Protocol

The protocol that created the route. This setting can be one of the following:

Setting	Description
Local	The route is for a network connected directly to the router.
Remote	The route is for a remote network accessed via a PPP connection.
Static	The route is a static route.
Static/RIP	The route is a static route that has been updated by RIP.
RIP	The route is a RIP route.

Setting	Description
IBGP	The route is an interior BGP route.
EBGP	The route is an exterior BGP route.
OSPF	The route is an OSPF route.

Idx

Used for static routes only. The index of the configured static route.

Interface

The interface over which the IP packet will be routed when using the route.

Status

The current status of the route. This setting can be one of the following:

Setting	Description
UP	The route is up and is ready for use in routing.
DOWN	The interface that the route uses is currently down. The interface can be activated if the route is required.
OOS	The interface that the route uses is currently “Out of Service”.



Command line

Command	Options	Action
route	print	Displays the IPv4 routing table.
route	printsrc	Displays the IPv4 routing table with the src addr information.

Show the IP hash table

The router uses an IP routing hash table to improve IPv4 routing performance by reducing route lookup times.

Web

Go to **Management > Network Status > IP Hash Table**.

The **IP Hash Table** contains information on recently routed IP packets such as source and destination IP address, IP protocol, etc, plus information on the interface and gateway in use when routing the IP packet. When the router receives an IP packet to route, it looks in the IP hash table before looking in the IPv4 routing table. Whenever the IPv4 routing table changes (such as a route is added, deleted or modified), all entries in the IP hash table are flushed out. To flush the IP hash table manually, click the **Flush** button. If there is no use of the table for **10** seconds, the router deletes entries in the IP hash table.

▼ IP Hash Table

Src IP Address	Src Port	Dest IP Address	Dest Port	Next Hop	IP Protocol	Interface	Age	Idx	Usage
10.10.5.59	2727	10.10.5.211	2427	0.0.0.0	UDP	-	30	0	31
10.10.5.3	0	224.0.0.10	0	0.0.0.0	88	-	1	3	1482
10.10.13.150	123	10.10.5.99	1908	0.0.0.0	UDP	-	1	4	0
10.10.5.30	50238	255.255.255.255	111	0.0.0.0	UDP	-	30	4	0
10.10.5.2	0	224.0.0.10	0	0.0.0.0	88	-	1	5	1484
10.10.13.150	123	10.10.5.212	1908	0.0.0.0	UDP	-	1	11	0
10.10.5.58	2727	10.10.5.166	2427	0.0.0.0	UDP	-	28	11	0
10.10.14.29	17500	10.10.14.255	17500	0.0.0.0	UDP	-	5	12	1
10.10.14.62	67	255.255.255.255	68	0.0.0.0	UDP	-	22	13	1

Src IP Address

The source IP address of the routed IP packet.

Src Port

The source TCP/UDP port of the routed IP packet. If the IP protocol is not TCP or UDP, then this field is **0**.

Destination IP Address

The destination IP address of the routed IP packet.

Dest Port

The destination TCP/UDP port of the routed IP packet. If the IP protocol is not TCP or UDP, this field is **0**.

Next Hop

The next hop gateway to which the routed IP packet was sent.

IP Protocol

The IP protocol field in the routed IP packet.

Interface

The interface in use when the IP packet was routed.

Age

The age, in seconds, of the entry in the IP hash table.

Idx

The index in the IP hash table of the entry.

Usage

The number of times the entry was used.

**Command line**

Command	Options	Action
route	hash	Displays the IP hash table.
route	flush	Flushes the IP hash table.

Show the port forwarding table

Web

Go to **Management > Network Status > Port Forwarding Table**.

The **Port Forwarding Table** page displays the Port Forwarding / NAT table. The router uses this table to keep track of IP packets that have been modified via NAT or NAPT to be routed over a particular network. When the router receives a response to a previously modified IP packet, it looks up the matching entry in the Port Forwarding table to correctly modify the response IP packet.

▼ Port Forwarding Table

Src IP Address	Dest IP Address	IP Protocol	Src Port	NAPT Port	Dest Port	TTL
192.168.0.120	10.1.2.100	ICMP	512	512	0	10
10.1.48.17	10.1.48.255	UDP	138	57345	138	56

2 current entries
78 free entries

Src IP Address

The source IP address of the modified IP packet.

Dest IP Address

The destination IP address of the modified IP packet.

IP Protocol

The IP protocol field of the modified IP packet.

Src Port

The source TCP/UDP port of the modified IP packet. For ICMP packets, this defines the ICMP Echo identifier value.

NAPT Port

The new destination TCP/UDP of the modified IP packet. For ICMP packets, this defines the ICMP Echo identifier value.

Dest Port

The original destination TCP/UDP port of the modified IP packet.

TTL

The time to live, in seconds, for the Port Forwarding entry. The router deletes any entries not in use during this specified amount of time from the Port Forwarding table.

Command line

Command	Options	Action
nat	list	Displays the Port Forwarding / NAT table.

Show firewall statistics

Web

Go to **Management > Network Status > Firewall**.

The **Firewall** page displays the current firewall statistics and the Firewall Stateful Inspection table.

Passed Packets

The number of packets the firewall has passed.

Blocked Packets

The number of packets the firewall has blocked.

Logged Packets

The number of packets the firewall has logged.

Stateful Packets

The number of packets that have matched a stateful rule.

Undersized Packets

The number of packets received by the firewall that are too small.

Oversized Packets

The number of packets received by the firewall that are too large.

Return TCP RST

The number of times the firewall has returned a TCP Reset packet.

Return ICMP

The number of times the firewall has returned an ICMP packet.

Stateful rule shortages

The number of times there has been a shortage of entries stateful inspection table.

HASH table errors

The number of hashing errors when looking into the stateful inspection table.

In use stateful rules reused

The number of times an in-use stateful inspection table has been reused.

Firewall Stateful Inspection Table

The Firewall Stateful Inspection table is a sophisticated, scripted stateful firewall and route inspection engine. Stateful inspection is a powerful tool allowing the router to keep track of a TCP/UDP or ICMP session and match packets based on the state of the connection on which they are being carried.

The table contains a list of dynamic firewall rules that have been created when packets have matched a configured firewall with the **inspect-state** keyword specified. See the [\[inspect-state\]](#) keyword description for more information on stateful inspection.

▼ Firewall Stateful Inspection Table

TTL	Hits	Direction	Src IP Addr	Src Port	Dst IP Addr	Dst Port	Trans. Src IP Addr	Trans. Src Port	Trans. Dst IP Addr	Trans. Dst Port	Protocol	Interface
7	2	OUT	213.152.58.85	1093	212.104.130.9	53	0.0.0.0	0	0.0.0.0	0	UDP	PPP 1

TTL

The number of seconds for the table entry to live. When this reaches **0**, the entry is removed from the table.

Hits

The number of times an IP packet has been matched against the firewall rule.

Direction

The direction of the IP packets that match the firewall rule.

Src IP Addr

The source IP address of the IP packets that match the firewall rule.

Src Port

The source TCP/UDP port of the IP packets that match the firewall rule.

Dest IP Addr

The destination IP address of the IP packets that match the firewall rule.

Dest Port

The destination TCP/UDP port of the IP packets that match the firewall rule.

Trans. Src IP Addr

If the firewall is configured to modify (such as NAT or NAPT) the source IP address of the IP packets that match the firewall, this defines the new source IP address of the IP packets.

Trans. Src Port

If the firewall is configured to modify (such as NAPT) the source TCP/UDP port of the IP packets that match the firewall, this defines the new source TCP/UDP port of the IP packets.

Trans. Dest IP Addr

If the firewall is configured to modify (such as NAT or NAPT) the destination IP address of the IP packets that match the firewall, this defines the new destination IP address of the IP packets.

Trans. Dest Port

If the firewall is configured to modify (such as NAPT) the destination TCP/UDP port of the IP packets that match the firewall, this defines the new destination TCP/UDP port of the IP packets.

Protocol

The IP protocol of the IP packets that match the entry.

Interface

The interface over which the IP packets that match the entry are sent or received.

**Command line**

Command	Options	Action
fwall	show	Displays the firewall stateful inspection table.

Show firewall trace output

Using the **log** keyword in a firewall rule appends output to the firewall trace output. Typically, the last rule in the form block log break end uses the **log** keyword to log a summary of all packets not matching one of the allow rules. The **log** keyword provides more logging flexibility; see the **log** action description in [Use firewall scripts](#).

Here is example firewall trace output from a firewall rule, showing two logged packets. Output for the first packet is:

```

block log break end
----- 5-10-2009 23:12:08 -----
FW LOG Dir: IN Line: 37 Hits: 4730 IFACE: ETH 3
Source IP: 222.45.112.59 Dest IP: 217.34.133.21 ID: 256 TTL: 106 PROTO: TCP (6)
Src Port: 12200 Dst Port: 8118
block log break end
-----
----- 5-10-2009 23:13:15 -----
FW LOG Dir: IN Line: 37 Hits: 4731 IFACE: ETH 3
Source IP: 218.61.22.42 Dest IP: 217.34.133.21 ID: 35372 TTL: 136 PROTO: TCP (6)
Src Port: FTP CTL (21) Dst Port: 16794
block log break end
-----
    
```

Next is the time stamp of the blocked packet.

```

----- 5-10-2009 23:12:08 -----
FW LOG Dir: IN Line: 37 Hits: 4730 IFACE: ETH 3
Source IP: 222.45.112.59 Dest IP: 217.34.133.21 ID: 256 TTL: 106 PROTO: TCP (6)
Src Port: 12200 Dst Port: 8118
    
```

- **Dir** is the direction of the packet that was logged, either IN or OUT of the router.
- **Line** is the line number within the firewall rules that caused this packet to be logged.
- **Hits** is the number of packets that have matched this rule.
- **IFACE** is the interface which the packet was logged on.
- **Source IP** is the source IP address of the packet that was logged.
- **Dest IP** is the destination IP address of the packet that was logged.
- **ID** is the ID of the packet, this is taken from the packet header.
- **TTL** is the Time To Live value.
- **PROTO** is the layer 3 protocol of the logged packet.
- **Src Port** is the source TCP or UDP port number of the packet that was logged.
- **Dst Port** is the destination TCP or UDP port number of the packet that was logged.
- **block log break end** is the actual rule that caused the packet to be logged.

Command line

Command	Options	Action
type fwlog.txt	n/a	Displays the current firewall trace.

Show DHCP status

Web

Go to **Management > Network Status > DHCP**.

▼ DHCP Status

IP address	Hostname	Lease time left (mins)
192.168.0.101	IKY-CMS-JPINKNE	20154
192.168.0.102	MAZ	20159

IP Address

The IP address assigned to the hostname.

Hostname

The hostname to which the IP address has been assigned.

Lease time left (mins)

The length of time, in minutes, the IP address lease is valid for. After this time, the DHCP client will need to renew its IP address.

Mac Address

The MAC address.

Command line

Command	Instance	Parameter	Action
dhcp	0	status	Displays the current status of the DHCP table.
dhcp	0	clear	Deletes all the entries in the DHCP table.

Show DNS status

Web

Go to **Management > Network Status > DNS Status**.

▼ DNS Status

Hostname	IP Address	TTL
www.bbc.co.uk	212.58.244.70	18
www.google.com	173.194.36.104	282
www.digi.com	172.16.1.69	287

Hostname

The hostname that has been resolved.

IP Address

The IP address of the hostname.

TTL

The time to live, in seconds, for the DNS entry. When the TTL reaches **0**, the entry is deleted.

Command line

Command	Instance	Parameter	Action
dns	0	status	Displays the current status of the DNS table.
dns	0	clear	Deletes all the entries in the DNS table.

Show IGMP status



Go to **Management > Network Status > IGMP Status**.

Show Quality of Service (QoS) status

Web

Go to **Management > Network Status > QoS. Status.**

The **Ethernet** QoS status pages display the current Quality of Service (QoS) status table for a particular interface. The **Advanced** pages show the Quality of Service for any PPP interfaces. Both displays show the same type of information. For example:

▼ QoS
 ▼ Ethernet
 ▼ ETH 0
 QOS 8 Status

Priority Q	TX rate (kbps)	Limit	Weighted Q length	Q length
0	0	64	0	0
1	0	64	0	0
2	0	64	0	0
3	0	64	0	0
4	0	64	0	0
5	0	64	0	0
6	0	64	0	0
7	0	64	0	0
8	0	64	0	0
9	0	64	0	0

Priority Q

The priority queue in the table.

TX rate (kbps)

The current transmit rate in kbps of the queue.

Limit

The current transmit rate limit in kbps of the queue.

Weighted Q length

The weighted queue length using the Weighted Random Early Discard (WRED) algorithm.

Q length

The number of packets on the queue.

Show NTP status

Web

Go to **Management > Network Status > NTP Status**.

▼ NTP Status

```

Current system peer: None
                    Ref ID: 0.0.0.0
                    Leap bits: 3
                    Stratum: 15
                    Root Delay: 0.0000 seconds
                    Root Dispersion: 0.0000 seconds
                    Ref skew: 1.0000 seconds
                    Poll: 3
                    Time constant: 0
                    Last offset: 0.0000 seconds
                    Last interval: 0 seconds
                    Stability: 0 ppm
                    Drift compensation: 0 ppm
Time since last clock update: Never
Unapplied adjustment: 0.0000 seconds
Clock offset: 0.0000 seconds
Packets processed: 0
RX new version packets: 0
RX old version packets: 0
RX unknown version packets: 0
RX bad stratum: 0
RX bad length: 0

Software clock info
RTC source software
Clock frequency: 2000 Hz
Drift compensation: 0 ppm
Update direction: Faster
Primary ticks/update: 0
Secondary ticks/update: 0
Timezone offset: -21600 seconds
Had NTP update: Yes
Last NTP update: 17:21:56, 31 May
                  2017
    
```

Command line

To check the status of the NTP client, use the **ntpstat** command.

Show NTP system status information

```
ntpstat sys
```

Show NTP peer information

```
ntpstat peers
```

Reset system information and allow NTP to recalculate the drift compensation

```
ntpstat rst
```

Manage connections

There are several web interface pages and commands for viewing and managing connections for the TransPort router.

Show IP connections

Web

Go to **Manage > Connections > IP Connections**.

The **IP Connections** page displays the current status of the TCP sockets on the router.

The router has two types of sockets:

Socket type	Use
TCP Sockets	Reserved for WEB and FTP connections.
General Purpose Sockets	Any application for TCP connections can use this socket type.

TCP Sockets

▼ IP Connections

TCP Sockets

ID	SID	State	Local IP Addr	Local Port	Remote IP Addr	Remote Port
0	2	LISTEN	0.0.0.0	21	0.0.0.0	0
1	3	LISTEN	0.0.0.0	80	0.0.0.0	0
2	4	LISTEN	0.0.0.0	443	0.0.0.0	0
3	1622	ESTAB	10.10.14.21	80	10.10.13.34	64095
4	-1	CLOSED Closed (FW2)	10.10.14.21	80	10.10.13.34	64030
5	-1	CLOSED Closed (FW2)	10.10.14.21	80	10.10.13.34	64032
6	-1	CLOSED Closed (FW2)	10.10.14.21	80	10.10.13.34	63817
7	-1	CLOSED Closed (FW2)	10.10.14.21	80	10.10.13.34	63819
8	-1	CLOSED Closed (FW2)	10.10.14.21	80	10.10.13.34	63579
9	-1	CLOSED Closed (FW2)	10.10.14.21	80	10.10.13.34	63557
10	-1	CLOSED Closed (FW2)	10.10.14.21	80	10.10.13.34	63559
11	-1	CLOSED Closed (FW2)	10.10.14.21	80	10.10.13.34	62149
12	0	LISTEN	0.0.0.0	0	0.0.0.0	0
13	0	LISTEN	0.0.0.0	0	0.0.0.0	0
14	0	LISTEN	0.0.0.0	0	0.0.0.0	0

SYNs waiting : 0
Free SYN entries : 40, min 34

ID

The TCP socket identifier.

SID

An internal socket identifier.

State

The current state of the socket.

Local IP Addr

The IP address on the router in use for the TCP connection.

Local Port

The TCP port on the router in use for the TCP connection or which is being listened on.

Remote IP Address

The IP address of the remote device that has the TCP connection to the router.

Remote Port

The TCP port in use by the connected remote device.

SYNs Waiting

The number of TCP SYN packets that are currently being processed by the router.

Free SYN entries

The number of entries available to process an incoming TCP SYN packet.

General Purpose Sockets

 **Web**

General Purpose Sockets

ID	Owner	Protocol	Mode	State	Local Port	Remote IP Addr	Remote Port	Inactivity Timeout (secs)
0	ASY 0	TCP	Normal	Listening	4000			300
1	ASY 1	TCP	Normal	Listening	4001			300
2	ASY 2	TCP	Normal	Listening	4002			300
3	ASY 3	TCP	Normal	Listening	4003			300
4	ASY 4	TCP	Normal	Listening	4004			300
5	ASY 5	TCP	Normal	Listening	4005			300
6	ASY 6	TCP	Normal	Listening	4006			300
7	ASY 7	TCP	Normal	Listening	4007			300
8	ASY 8	TCP	Normal	Listening	4008			300
9	ASY 9	TCP	Normal	Listening	4009			300
10	ASY 10	TCP	Normal	Listening	4010			300
11	SSH 1	TCP	Normal	Listening	22			300
12	SSH 3	TCP	Normal	Listening	22			300
13	SSH 5	TCP	Normal	Listening	22			300
14	SSH 7	TCP	Normal	Listening	22			300
15	SSH 9	TCP	Normal	Listening	22			300
139	CMD	TCP	Normal	Listening	992			300
140	CMD	TCP	Normal	Listening	23			300

Total Number of Sockets : 141

Number of Free Sockets : 123

ID

The ID of the general purpose socket.

Owner

The software task that created the socket.

Protocol

The protocol in use by the socket.

Mode

The mode of operation of the socket.

State

The current state of the socket.

Local Port

The port of the router that in use by the socket.

Remote IP Addr

The IP address of the remote device that has a TCP connection with the socket.

Remote Port

The TCP port in use by the remote device.

Inactivity Timeout

The socket's inactivity timeout, in seconds. If the timer reaches **0** seconds, the TCP connection is closed.

Total Number of Sockets

The total number of general purpose sockets available on the router.

Number of Free Sockets

The number of free general purpose sockets available on the router.



Command line

Command	Options	Action
socks	None	Displays the current status of the TCP sockets.
gpstat	None	Displays the current status of the general purpose sockets.
gpstat	close <ID>	Closes the general purpose socket connection with the ID number specified.

Manage PPP connections

Web

Go to **Management > Connections > PPP Connections > PPP n**. PPP connection status fields and controls are as follows:

Raise Link

Activates the PPP connection.

Drop Link

Deactivates the PPP connection.

Link status

The current status of the PPP connection.

Uptime

The uptime for the PPP connection.

MRU

The maximum receive unit (MRU) for the local and remote ends of the PPP connection.

ACCM

The Asynchronous Control Character Map (ACCM) bit settings for the local and remote ends of the PPP connection.

VJ Compression

Whether Van Jacobson TCP/IP header data compression is on or off.

Link Active With Entity

The entity with which the PPP connection is active.

IP Address

The IP address of the local end of the PPP connection.

DNS Server IP Address

The IP address of the DNS server for the PPP connection.

Secondary DNS Server IP Address

The IP address of the secondary DNS server for the PPP connection, if any.

Outgoing Call To

Identifies the destination of the outgoing call for the PPP connection.



Command line

Use the **pppstat n** command, where **n** is the PPP interface number (**0-19**).

Show VPN connections

Web

Go to **Management > Connections > VPN**.

There are several sub-menus:

- **IPsec:** Displays IPsec tunnel connections
- **IPsec Peers:** Displays IPsec peers
- **IKE SAs:** Displays the current status of the Internet Key Exchange (IKE) Security Associations (SA)
- **OpenVPN:** Displays OpenVPN connections and their current status

Show IPsec tunnel connections

Go to **Management > Connections > VPN > IPsec > IPsec Tunnels**.

Outbound V1 SAs											
#	Peer IP Addr	Local Network	Remote Network	AH	ESP Auth	ESP Enc	IP Comp	KBytes Delivered	KBytes Left	Time Left (secs)	Interface
0	217.34.██████	1.1.1.1/32	1.1.1.2/32	N/A	SHA1	AES(128)	N/A	1	0	86188	PPP 3
<input type="button" value="Remove All"/>											
Inbound V1 SAs											
#	Peer IP Addr	Local Network	Remote Network	AH	ESP Auth	ESP Enc	IP Comp	KBytes Delivered	KBytes Left	Time Left (secs)	Interface
0	217.34.██████	1.1.1.1/32	1.1.1.2/32	N/A	SHA1	AES(128)	N/A	0	0	86188	PPP 3
<input type="button" value="Remove All"/>											
Outbound V2 SAs											
No Tunnels											
Inbound V2 SAs											
No Tunnels											
<input type="button" value="Refresh"/>											

#

IPsec tunnel number.

SPI

The Security Parameters Index (SPI) is a pointer that references the session key and algorithm for protecting the data in the IPsec tunnel.

Peer IP

The IP address of the remote device that is the other end of the IPsec tunnel.

Local Network

The local IP network of the IPsec tunnel that is connected to the router.

Remote Network

The remote IP network of the IPsec tunnel that is connected to the remote device.

First Rem. IP / Last Rem. IP

For IPsec tunnels that have been negotiated using IKEv2, this is the range IP addresses available on the remote IP network.

First Loc. IP / Last Loc. IP

For IPsec tunnels that have been negotiated using IKEv2, this is the range IP addresses available on the local IP network.

AH

The AH algorithm in use, if any.

ESP Auth

The ESP authentication algorithm in use, if any.

ESP Enc

The ESP encryption algorithm in use, if any.

IPComp

The data compression algorithm in use, if any.

KBytes Delivered

The total amount of data that has been transferred (in both directions) over this IPsec tunnel.

KBytes Left

The amount of data left to be transferred over the IPsec tunnel before the data duration limit is reached. The data duration is negotiated between the router and the remote device.

Time Left

The time left, in seconds, before the time duration limit is reached. The time duration is negotiated between the router and the remote device.

Interface

The interface over which the IPsec tunnel operates.

Show status of IPsec peers

Go to **Management > Connections > VPN > IPsec > IPsec Peers**. This page displays the current status of the IPsec peers. This is the list of remote devices that have successfully negotiated an IPsec tunnel with the router.

▼ IPsec Peers						
Peer IP Address	Our ID	Peer ID	Dead Peer Detection (DPD)	NATT Local Port	NATT Remote Port	
217.34.⊠⊠⊠⊠	REM-TEST	SARIAN-BG	Inactive. Next REQ in 119 secs	4500	4500	
<input type="button" value="Remove all unused"/>						

Peer IP Address

The IP address of the remote device.

Our ID

The ID of the router.

Peer ID

The ID of the remote device.

Dead Peer Detection (DPD)

The DPD status and the time until the next DPD request.

NATT Local Port

The local NAT-Traversal port.

NATT Remote Port

The remote NAT-Traversal port.

Show status of IKE SAs

Go to **Management > Connections > VPN > IPsec > IKE SAs** This page displays the current status of the IKE Security Associations (SA).

IKEv1 SAs

Our ID	Peer ID	Peer IP Address	Our IP Address	Time Left (secs)	Session ID	Internal ID
REM-TEST SARIAN-BG	217.34.00000000	10.94.60.189	85599	0x0	6	<input type="button" value="Remove"/>

IKEv2 SAs

No SAs

Our ID

The ID of the router.

Peer ID

The ID of the remote device with which the IKE SA has been negotiated.

Peer IP Address

The IP address of the remote device.

Our IP Address

The IP address the router uses to negotiate the IKE SA.

Time Left

The time remaining, in seconds, for the IKE SA to remain in force.

Session ID

The ID of the IKE SA.

Internal ID

An internal identifier for the IKE SA.

Show status of OpenVPN instances

Web

Go to **Management > Connections> VPN > OpenVPN > OVPN n.**

▼ Virtual Private Networking (VPN)

- ▶ IPsec
- ▼ OpenVPN
 - ▼ OVPN 0

Name:
Link Inactive

Bytes Received: 0	Bytes Sent: 0
Packets Received: 0	Packets Sent: 0
Pings Received: 0	Pings Sent: 0
Ping Timeouts: 0	Key Renegotiations: 0
Packet Replays Detected: 0	

Raise Link

Activates the OpenVPN connection.

Drop Link

Deactivates the OpenVPN connection.

Name

The name of the OpenVPN connection.

Link status field

The current status of the OpenVPN connection.

Bytes Received

The number of bytes received over the OpenVPN connection.

Bytes Sent

The number of bytes sent over the OpenVPN connection.

Packets Received

The number of packets received over the OpenVPN connection.

Packets Sent

The number of packets sent over the OpenVPN connection.

Pings Received

The number of pings received over the OpenVPN connection.

Pings Sent

The number of pings sent over the OpenVPN connection.

Ping Timeouts

The number of ping timeouts that have occurred over the OpenVPN connection.

Key Renegotiations

Number of times the OpenVPN encryption keys have been renegotiated on the connection.

Packet Replays Detected

The number of packet replays detected over the OpenVPN connection.

 **Command line**

Command	Instance	Parameter	Description
sastat	None	[dyn]	Displays the current status of all of the IPsec tunnels. You can use the optional dyn parameter to display the status of the dynamic IPsec tunnels.
sastat	None	[dyn] <first> <last>	Displays the current status of the IPsec tunnels in the range from <first> to <last>. such as sastat 0 49 or sastat dyn 0 49 .
sastat	None		Displays the current status of the IPsec tunnels that match the given peer. The <peer> value can contain the * wildcard character. such as sastat peer uk-north-* or sastat dyn peer uk-north-* .
ovpn	n	status	Displays status of an OpenVPN connection (equivalent of Management > Connections> VPN > OpenVPN > OVPN n).
ovpn	n	deact_rq	Disconnects an OpenVPN connection (equivalent of Drop Link button)
ovpn	n	act_rq	Connects an OpenVPN connection (equivalent of Raise Link button)

Show GPS data

Web

Go to **Management > Telemetry > GPS**.

The **GPS** page displays a summary of the most recent information received from the GPS module (if fitted) and the status of the IP connections.

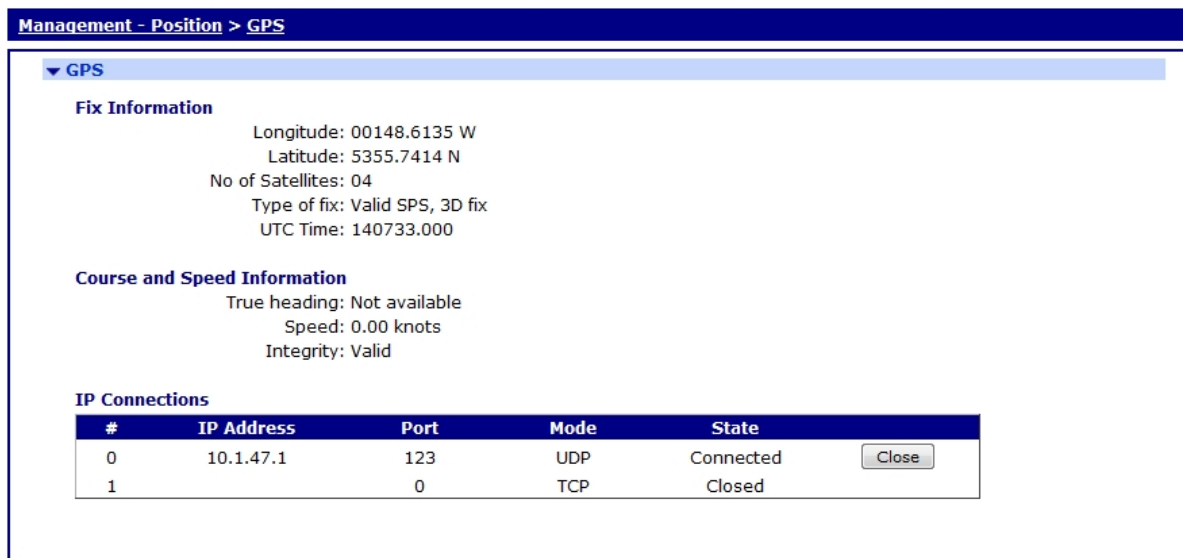

The screenshot shows a web interface for 'Management - Position > GPS'. It contains three sections: 'Fix Information', 'Course and Speed Information', and 'IP Connections'. The 'IP Connections' section features a table with columns for '#', 'IP Address', 'Port', 'Mode', and 'State'. A 'Close' button is located to the right of the table.

#	IP Address	Port	Mode	State
0	10.1.47.1	123	UDP	Connected
1		0	TCP	Closed

Copyright © Digi International, Inc. All rights reserved.

Longitude

The current longitude contained in the last GGA, GLL or RMC message from the GPS module.

Latitude

The current latitude contained in the last GGA, GLL or RMC message from the GPS module.

No of Satellites

The current number of satellites in use, as indicated in the last GGA message from the GPS module.

Type of fix

The current fix status as indicated in the last GGA, GLL or RMC message, followed by the type of fix (such as 2D, 3D or no fix) as indicated in the last GSA message.

UTC

The current UTC time as indicated in the last ZDA, GGA, GLL or RMC message from the GPS module.

True Heading

The current true heading as indicated in the last RMC message from the GPS module. If the router is not moving, this value is not available.

Speed

The current speed, as indicated in the last RMC message from the GPS module.

Integrity

The current data integrity as indicated in the last RMC message from the GPS module. It can be either **Valid** or **Not Valid**.

IP Connections

The current IP address, port number, connection type and status of the IP connections.

 **Command line**

Command	Options	Action
at\mibs=gps.0.stats		Displays the current status of the GPS receiver.

View and manage the event log

Web

Go to **Management > Event Log**.

The **Event Log** page displays the current contents of the event log on the router.

Management - Event Log

```

22:06:12, 30 May 2017,WEB Login OK by username lvl 0
22:05:41, 30 May 2017,Software Mon ETH 24 OAU:0
21:37:10, 30 May 2017,WEB Login OK by username lvl 0
21:36:34, 30 May 2017,Software Mon ETH 23 OAU:0
21:36:34, 30 May 2017,Software Mon ETH 24 OAU:0
20:44:07, 30 May 2017,WEB Login OK by username lvl 0
20:44:00, 30 May 2017,Software Mon ETH 23 OAU:0
20:44:00, 30 May 2017,Software Mon ETH 24 OAU:0
20:23:07, 30 May 2017,Network technology changed to LTE
20:23:06, 30 May 2017,PPP 1 up
20:23:06, 30 May 2017,PPP 1 Start
20:23:06, 30 May 2017,Modem connected on asy 5
20:23:04, 30 May 2017,Modem dialing on asy 5 #:*98*1#
20:22:59, 30 May 2017,GPRS Attachment On
20:22:54, 30 May 2017,PPP 1 down,LL disconnect
20:22:54, 30 May 2017,Modem disconnected on asy 5,18
20:22:52, 30 May 2017,QMI interface attached to MODEM:0
20:22:52, 30 May 2017,ASY 7 assigned to usb-1.1 (Android)
20:22:52, 30 May 2017,ASY 6 assigned to usb-1.1 (Android)
20:22:52, 30 May 2017,ASY 5 assigned to usb-1.1 (Android)
20:22:52, 30 May 2017,USB-1 device 3 connected: Android
20:22:52, 30 May 2017,Time set/changed OK
20:22:50, 30 May 2017,SNTP Client,Time Set Request
20:22:45, 30 May 2017,Modem dialing on asy 5 #:*98*1#
20:22:33, 30 May 2017,ETH 0 cable connect
20:22:32, 30 May 2017,USB-1 device 2 connected: product 0x2514
  
```

Refresh Clear Log Open in New Window

The event log is stored in a pseudo-file named **eventlog.txt**. It acts as a circular buffer, so when there is no space available for new entries, the oldest entries are overwritten.

Each entry in the log normally consists of a single line containing the date, time and a brief description of the event. In some case it may also identify:

- The type/number of the protocol instance the generated the message, such as **PPP 0**.
- A reason code.
- Additional information such as an X.25 address or ISDN telephone number.

The specific events that generate a log entry are pre-defined and cannot be altered although the text and priority of each event can be modified. This can be done via the **Configuration > Alarms > Event Logcodes** page.

 **Command line**

Command	Options	Action
type eventlog.txt	None	Displays the contents of the event log.
clear_ev	None	Clears the contents of the event log.

Analyze data traffic

Using the Analyser, you can configure the router to capture a trace of the data being transmitted and received on the various interfaces. The Analyser can capture the layer 1, 2, and 3 protocol data and present it in an easily readable format.

Capture data traffic

Web

1. Go to **Management > Analyser > Settings**.
2. Configure the Analyser to capture data traffic:

Enable Analyser

Enables or disables the Analyser.

Maximum packet capture size

The number of bytes that are captured and stored for each packet. If the packet is bigger than the configured size, the packet is truncated. Bear in mind that the larger this value, the quicker the pseudo file **ana.txt** will become full so that the effective length of the Analyser trace is reduced.

Log Size

The maximum size of the pseudo file **ana.txt** for storing the captured data packets. Once the maximum size is reached, the oldest captured data packets are overwritten when new packets are captured. The maximum value is **180** Kb, but since the data is compressed, more than **180** Kb of trace data will be captured.

Protocol layers

The check-boxes under this heading specify which protocol layers are captured and included in the Analyser trace. You can choose to capture **Layer 1** (physical / PPP), **Layer 2** (Layer protocol, the Network Layer (**Layer 3**) protocol or any combination, by checking or clearing the appropriate check-boxes. In addition, you may select **XOT** (X.25 over TCP/IP) tracing if this feature is included on the router.

Enable IKE debug

Enables or disables including IKE packets in the Analyser trace when using IPsec.

Enable QMI trace

Enables or disables including data from the Qualcomm Management Interface in the Analyser trace.

Enable SNAIP trace

Enables or disables including the SNAIP packet in the Analyser trace.

ISDN Sources

Selects the ISDN channels (**D**, **B1** and **B2**) over which packets will be captured and included in the Analyser trace.

LAPB Links

Selects the LAPB links over which packets are captured and included in the Analyser trace.

Serial Interfaces

Selects the serial interfaces over which packets will be captured and included in the Analyser trace. The list of available interfaces include the physical serial interfaces, internal virtual serial interfaces (if present), and interfaces the built-in WWAN and/or PSTN modems use.

Ethernet Interfaces

Selects the Ethernet interfaces over which packets are captured and included in the Analyser trace.

Raw SYNC Sources

Selects the synchronous sources over which packets are captured and included in the Analyser trace.

DSL PVC Sources

Selects the ADSL ATM PVCs over which packets are captured and included in the Analyser trace.

PPP Interfaces

Selects the PPP interfaces over which packets are captured and included in the Analyser trace.

IP Sources

Selects the IP sources over which packets are captured and included in the Analyser trace. These sources include IP packets transmitted and received over Ethernet, PPP and OpenVPN (OVPN) interfaces. It is also possible to select GRE Tunnels via the advanced sections of the individual GRE Tunnel configuration pages.

IP Options:**Trace discarded packets**

Enables or disables the capture of packets that are discarded by an interface, and displays a reason for why the packet was discarded.

Trace loopback packets

Enables or disables the capture of IP loopback packets.

IP Packet Filters / Discarded IP Packet Filters options**TCP/UDP Ports**

Filters out TCP or UDP packets with particular source or destination port numbers. The format of this parameter is a comma-separated list of port numbers. For example, suppose you want to exclude the capture of Telnet and HTTP traffic that would otherwise swamp the data of interest. To do this, enter **23,80** for this parameter. Conversely, to capture traffic on a specific source or destination port only, use a tilde (~) symbol before the list of ports. For example, to only capture Telnet and SSH packets, enter **~22,23** for this parameter.

IP Protocols

Filters out IP packets with particular IP protocol numbers. The format of this parameter is a comma-separated list of protocol numbers. For example, suppose you want to exclude the capture of TCP traffic that would otherwise swamp the data of interest. To do this, enter **6** for this parameter. Conversely, to capture traffic with a specific IP protocol number only, use a

tilde (~) symbol before the list of protocol numbers. For example, to only capture UDP traffic, enter ~17 for this parameter.

IP Addresses

Filters out IP packets with particular source or destination IP addresses. The format of this parameter is a comma-separated list of IP addresses. For example, you may want to exclude the capture of traffic from IP hosts 10.1.2.3 and 10.2.2.2. To do this, enter 10.1.2.3,10.2.2.2 for this parameter. Conversely, to capture traffic to and from particular IP hosts only, use a tilde (~) symbol before the list of IP addresses. For example, to only capture packets to and from IP host 192.168.47.1, enter ~192.168.47.1 for this parameter.

3. Click **Apply**.

 **Command line**

Command	Instance	Parameter	Values	Equivalent web parameter
ana	0	anon	on, off	Enable Analyser
ana	0	maxdata	16-2000	Maximum packet capture size
ana	0	logsize	3 -180	Log Size
ana	0	l1on	on, off	Protocol Layers / Layer 1
ana	0	l2on	on, off	Protocol Layers / Layer 2
ana	0	l3on	on, off	Protocol Layers / Layer 3
ana	0	xoton	on, off	Protocol Layers / XOT
ana	0	ikeon	on, off	Enable IKE debug
ana	0	qmion	on, off	Enable QMI trace
ana	0	snaipon	on, off	Enable SNAIP trace
ana	0	lapdon	0-7 See below	ISDN Sources
ana	0	lapbon	0-7 See below	LAPB Links
ana	0	asyon	Bitmap See below	Serial Interfaces
ana	0	syon	Bitmap See below	Raw SYNC Sources
ana	0	discardson	on, off	IP Options / Trace discarded packets
ana	0	loopon	on, off	IP Options / Trace loopback packets
ana	0	ipfilt	Comma-separated list	IP Packet Filters / TCP/UDP Ports

Command	Instance	Parameter	Values	Equivalent web parameter
ana	0	ipprotfilt	Comma-separated list	IP Packet Filters / IP Protocols
ana	0	ipaddfilt	Comma-separated list	IP Packet Filters / IP Addresses
ana	0	discportfilt	Comma-separated list	Discarded IP Packet Filters / TCP/UDP Ports
ana	0	discprotfilt	Comma-separated list	Discarded IP Packet Filters / IP Protocols
ana	0	discipaddfilt	Comma-separated list	Discarded IP Packet Filters / IP Addresses
eth	n	ethanon	on, off	Ethernet Interfaces
eth	n	ipanon	on, off	IP Sources
ovpn	n	ipanon	on, off	IP Sources
ppp	n	ipanon	on, off	IP Sources
ppp	n	pppanon	on, off	PPP Interfaces
tun	n	ipanon	on, off	GRE IP Sources
tun	n	tunanon	on, off	GRE Tunnel Interfaces

Related CLI commands not available via the web interface

Command	Instance	Parameter	Values	Action
ana	0	fcon	on, off	Enables serial flow control tracing.
ana	0	stopbufs	0-255	Stops Analyser when number of free system buffers matches this value.
ana	0	stopmsgs	0-255	Stops Analyser when number of free system messages matches this value.
ana	0	stopflood	0-1	Stops Analyser when Ethernet flood protection is activated.
ana	0	lowbufcmd	Command String	Run this command when the number of free system buffers match lowbuflevel .
ana	0	lowbuflev	Integer	Displays the free system buffer threshold that lowbufcmd uses.
ana	0	lowmsgcmd	Command String	Run this command when the number of free system messages match lowmsglevel .
ana	0	lowmsglev	Integer	Displays the free system message threshold that lowmsgcmd uses.

Command	Instance	Parameter	Values	Action
ana	0	logdrive	String	Specifies an alternate file system drive on which to store the Analyser trace. To use an external USB flash device, this should be set to u : If the router has an internal SDIO flash device, select it by specifying s :
ana	0	logfile	Filename	Stores the Analyser trace in the named file on an alternate drive.
ana	0	contfile	Filename	Stores the Analyser trace in the named file on an alternate drive once the file indicated by logfile is reaches its max size as specified by logsizek .
ana	0	logsizek	Value in Kbytes	Sets the maximum size in Kbytes of the file on the alternate drive. When set to 0 , the file size is only limited by the flash device.

ISDN Sources

LAPD2	LAPD1	LAPD0	Value
OFF	OFF	OFF	0
OFF	OFF	ON	1
OFF	ON	OFF	2
OFF	ON	ON	3
ON	OFF	OFF	4
ON	OFF	ON	5
ON	ON	OFF	6
ON	ON	ON	7

LAPB Links

LAPD1	LAPD0	Value
OFF	OFF	0
OFF	ON	1
ON	OFF	2
ON	ON	3

Serial Interfaces

Interface	Value
Serial 0	1
Serial 1	2
Serial 2	4
Serial 3	8
Serial 4	16
Serial 5	32
Serial 6	64
Serial 7	128
Serial 8	256
Serial 9	512
Serial 10	1024
Serial 11	2048
Serial 12	4096

To enable the Analyser on multiple serial interfaces, add the appropriate values together. For example, to enable the Analyser on serial interfaces **2** and **3**, the value should be **12 (4+8)**.

The number of serial interfaces can vary on different depending on which hardware and software options are available.

Raw Sync Interfaces

Interface	Value
ISDN D	1
ISDN B1	2
ISDN B2	4
Physical Port 0	8
Physical Port 1	16

To enable the Analyser on multiple serial interfaces, add the appropriate values together. For example, to enable the Analyser on Physical Ports **0** and **1**, the value should be **24 (8+16)**.

Show captured data traffic

Web

Go to **Management > Analyser > Trace** to view the current Analyser trace.

Management - Analyser > Trace

▶ Settings

▼ Trace

```

----- 15-12-2010 14:26:50.400 -----
45 00 00 28 24 15 00 00 FA 06 56 81 0A 01 2F 1E   E.....V....
0A 01 03 1A 03 03 FD 0D 1A CB C3 5C 74 4F E5 E8   .....EÄ.tOâè
50 10 20 00 11 2A 00 00                           P.....

IP (Final) From LOC TO REM   IFACE: ETH 0
45                          IP Ver:      4
                             Hdr Len:    20
00                          TOS:        Routine
                             Delay:        Normal
                             Throughput:    Normal
                             Reliability:    Normal
00 28                       Length:      40
24 15                       ID:          9237
00 00                       Frag Offset: 0
                             Congestion:   Normal
                             May Fragment
                             Last Fragment

FA                          TTL:        250
06                          Proto:      TCP
56 81                       Checksum:  22145
0A 01 2F 1E                 Src IP:    10.1.47.30
0A 01 03 1A                 Dst IP:    10.1.3.26
TCP:

```

▶ PCAP (e.g. Wireshark) traces

Copyright © Digi International, Inc. All rights reserved.

Command line

Command	Options	Action
type ana.txt	None	Displays the contents of the event log.
ana 0 anaclr	None	Clears the contents of the event log.

Set PCAP (such as Wireshark) traces

The traffic captured by the Analyzer is also available in PCAP format.

A network protocol analyzer, such as Wireshark, can read files in this PCAP format. This powerful feature allows you to diagnose network protocol issues with relative ease.

There are several PCAP files available to download. Each file contains a different set of captured packets.

Option	PCAP File	Contents
IP	anaip.pcap	IP traffic captured from all enabled IP sources.
Ethernet	anaeth.pcap	Ethernet traffic captured from all enabled Ethernet sources.
PPP	anappp.pcap	PPP traffic captured from all enabled PPP sources.
Wi-Fi	anawifi.pcap	Wi-Fi traffic captured from the enabled Wi-Fi source.

Wireshark is free software. To download, go to <http://www.wireshark.org>.

Web

1. Go to **Management > Analyser > PCAP (e.g. Wireshark) traces**.
2. Click the displayed links to download the desired PCAP-format file.

Following is an example of Analyzer traffic output viewed in Wireshark:

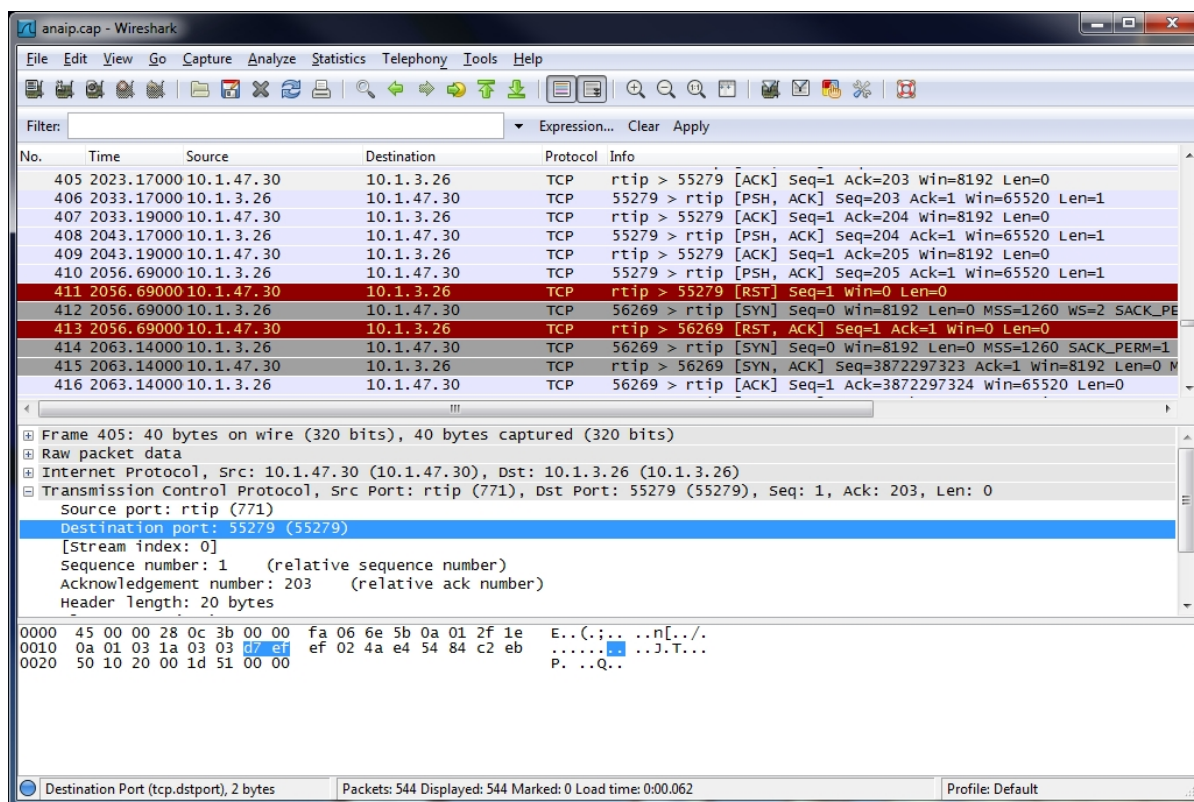

Use the Top Talkers monitor

The router can be configured to monitor the data being transmitted and received on the various interfaces. It is able to report which IP hosts are generating the most traffic over a period between **1** and **30** minutes.

Top Talkers also allows you to block particular IP traffic flows to stop them from using bandwidth. The **Management > Top Talkers** page has the following menu options:

Configure Top Talkers monitor

Web

1. Go to **Management > Top Talkers > Settings** .
2. Configure Top Talkers settings as desired:

Ethernet Interfaces

Selects the Ethernet interfaces Top Talkers will monitor.

PPP Interfaces

Selects the PPP interfaces Top Talkers will monitor.

3. Click **Apply**.

Command line

Entity	Instance	Parameter	Values	Equivalent web parameter
eth	n	ttalker	on, off	Ethernet Interfaces
ppp	n	ttalker	on, off	PPP Interfaces

Show the Top Talkers trace

Web

Go to **Management > Top Talkers > Trace** to show the current top talkers trace. For example:

Management - Top Talkers > Settings

Settings

Trace



Auto refresh off Refresh Resolve all addresses

Current rates

Interface	Control	Inbound IP	Outbound IP	Kbps In	Kbps Out
ETH 0	Block	? 255.255.255.255	? 0.0.0.0	 2	0 (0 bps)
ETH 0	Block	? 10.1.47.30	? 10.1.3.26 (iky-cms-jpinkne)	0 (346 bps)	0 (325 bps)
ETH 0	Block	? 255.255.255.255	? 10.1.51.1	0 (618 bps)	0 (0 bps)
ETH 0	Block	? 239.255.255.250	? 10.1.19.253	0 (392 bps)	0 (0 bps)
ETH 0	Block	? 239.255.255.250	? 10.1.51.1	0 (138 bps)	0 (0 bps)
ETH 0	Block	? 239.255.255.250	? 10.1.3.18	0 (138 bps)	0 (0 bps)
ETH 0	Block	? 10.1.255.255	? 10.1.255.112	0 (33 bps)	0 (0 bps)
ETH 0	Block	? 10.1.255.255	? 10.1.2.99	0 (5 bps)	0 (0 bps)
ETH 0	Block	? 10.1.255.255	? 10.1.3.35	0 (4 bps)	0 (0 bps)
ETH 0	Block	? 10.1.255.255	? 10.1.3.34	0 (4 bps)	0 (0 bps)

Total kbps IN: 3
Total kbps OUT: 0 (325 bps)

Previous minute average rates

Interface	Control	Inbound IP	Outbound IP	Kbps In	Kbps Out
ETH 0	Block	? 10.1.47.30	? 10.1.3.26 (iky-cms-jpinkne)	 4	 26
ETH 0	Block	? 255.255.255.255	? 0.0.0.0	 2	0 (0 bps)
ETH 0	Block	? 10.1.255.255	? 10.1.3.18	0 (136 bps)	0 (0 bps)
ETH 0	Block	? 239.255.255.250	? 10.1.51.1	0 (130 bps)	0 (0 bps)
ETH 0	Block	? 239.255.255.250	? 10.1.9.254	0 (130 bps)	0 (0 bps)

Performing device administration tasks

There are several administration tasks you may need to perform periodically on your TransPort router, such as displaying system information, managing files, managing certificates and keys, saving, backing up, and restoring the router's configuration, resetting or rebooting the router.

View system information

Web

Go to **Administration > System Information**.

The System Information provides an overview of router status.

Administration - System Information

Model: TransPort WR44v2
Part Number: WR44-U800-CE1-SU
Ethernet 0 MAC Address: 00:04:2D:04:B4:4D
Serial: 308301

Firmware Version: 5.2.18.3 (May 23 2017 09:40:45)
SBIOS Version: 7.61u
Build Version: LW
HW Version: 2202a

CPU Utilization: 1% (Min: 1%, Max: 33%, Avg: 1%)
Up Time: 2 hours 41 minutes 25 seconds
Date and Time: 30 May 2017 23:03:56
Total Memory: 65536 KB
Used Memory: 50275 KB
Free Memory: 15261 KB

Mobile Module: Telit LTE
SW Opts: 0x141 0x0
SW Cnts: 5 0 0 0 3 0 0 0 0 29 0 0 0 0 0 0 0 0 0 0
Switch Mode: Hub

Model

The model of the router.

Part Number

The Digi part number of the router.

Ethernet 0 MAC Address

The MAC address of the **Ethernet 0** interface.

Firmware Version

The firmware version that is currently running on the router.

SBIOS Version

The SBIOS firmware version that is currently running on the router.

Build Version

The build configuration of the firmware that is currently running on the router.

HW Version

The hardware version on the router. This item may be blank.

CPU Utilization

The current and historical CPU utilization since the router booted up.

Up Time

The amount of time since the router booted up.

Date and Time

The current date and time on the router.

Total Memory

The total amount of RAM that is fitted on the router.

Used Memory

The amount of RAM that is currently in use on the router.

Free Memory

The amount of RAM that is currently free on the router.

Mobile Module

Which mobile module is fitted on the router.

SW Opts

Which firmware options are enabled on the router.

SW Cnts

Configuration parameters in use by firmware.

Switch Mode

The current setting of the Ethernet switch on routers with multiple Ethernet interfaces. It can be either **Hub** or **Port Isolate**.

 **Command line**

Command	Options	Equivalent web parameter
ati5	n/a	Model Firmware Version SBIOS Version Build Version Mobile Module SW Opts
hw	n/a	Part Number Ethernet 0 MAC Address HW Version
cpu	n/a	CPU Utilization
uptime	n/a	Up Time
time	n/a	Date and Time
mem	n/a	Total Memory Used Memory Free Memory

Manage files

Web

To manage files, go to **Administration > File Management**.

FLASH directory

The **Administration > File Management > FLASH Directory** web page displays the files held on the router’s flash file system. The router has its own flash memory file system that uses DOS-like filenames of up to 12 characters long: **8** characters, followed by the **.** separator, and a **3-character** extension. The filing system stores the system software, web pages, configuration information, and statistics in a single root directory. Files appear as hyperlinks, which can be downloaded and displayed in the web browser as long as an appropriate viewer is installed and a file association with the viewer has been made. The directory listing of files on the FLASH directory also shows the file size, the access of **rw** (read write) or **ro** (read only) and the date the file was last modified. Below the file list is a summary of the FLASH file system, including the number of files, FLASH free, and FLASH used. For example:

Administration - File Management > FLASH Directory

FLASH Directory				
Action	File Name	Size	Access	Last Modified
	user	<DIR>		
	direct	101280 bytes	ro	13:10:36, 01 Feb 2015
	sbios	262144 bytes	ro	09:25:15, 20 Feb 2018
	mirror	101280 bytes	ro	13:10:36, 01 Feb 2015
<input type="checkbox"/>	image4	5661575 bytes	rw	09:25:13, 20 Feb 2018
<input type="checkbox"/>	image	5661575 bytes	rw	09:24:49, 20 Feb 2018
<input type="checkbox"/>	config_da0	17479 bytes	rw	07:45:27, 26 Feb 2018
<input type="checkbox"/>	logcodes.txt	20888 bytes	rw	09:24:58, 20 Feb 2018
<input type="checkbox"/>	sregs.dat	4096 bytes	rw	15:15:11, 21 Feb 2018
	sregs.fac	4096 bytes	ro	13:10:36, 01 Feb 2015
<input type="checkbox"/>	manual.sb	26114 bytes	rw	17:14:02, 25 Jan 2018
<input type="checkbox"/>	activate.sb	32636 bytes	rw	17:14:02, 25 Jan 2018
<input type="checkbox"/>	CAcert.cer	1371 bytes	rw	13:10:36, 01 Feb 2015
<input type="checkbox"/>	prlupdate.sb	30569 bytes	rw	17:14:02, 25 Jan 2018

Sub-directories are not supported. Depending on the router mode, you can store a maximum of **80-300** files including system files, providing there is sufficient memory remaining.

You can upload new files into the router from a local terminal or from a remote system over the WAN connection. Existing files can be renamed or deleted using DOS-like commands.

Although the file system will only store a limited number of files, all those files associated with the web interface are stored in a single file with the **.web** extension and extracted as required.

Action

Selects each read/write file for deletion.

File

The name of the file in the flash file system.

Size (bytes)

The size of the file, in bytes. This is not a fixed value. When downloaded, the size of the downloaded file will be different.

Access

This is the access settings for the file.

Setting	Description
rw	Read / Write access
ro	Read Only access

Last Modified

The date and time of when the file was last modified.

Delete Selected Files button

Deletes the selected files.

WEB Directory

The **WEB** directory contains a list of the files held within the active web file. The web file is shown on the FLASH file system as a single file. This file is compressed and holds approximately 300 files.

Direct access to these files by an engineer is not normally required.

Administration - File Management > WEB Directory

FLASH Directory		
WEB Directory		
File	Size (bytes)	Compressed Size (bytes)
aalstat.asp	2601	987
adslcfg.asp	26568	9429
advforms.js	18586	7063
advnetcfg.asp	17460	7645
ana.asp	618	479
anacfg.asp	21393	6880
anatop.asp	1218	856
animated-overlay.gif	1738	1724
asycfg.asp	11762	5138
asystat.asp	4032	1717
backup.asp	9380	4138
base_cfg.asp	3081	1716
basiccfg.asp	5776	2330
bg_highlight-soft 75 ccccc 1x100.png	280	261
bgpcfg.asp	10211	4730
blue.gif	41	43
cacert.asp	13905	6704
camcfg.asp	7167	3032
cell_countries.js	47092	12690
cert.asp	25900	10809
certlist.asp	104	93
cflt.asp	7583	3383
combobox.js	6109	2005
COMJ.JS	16598	7063
config.eml	158	120

File

The name of the file in web file.

Size (Bytes)

The size of the file, in bytes.

Compressed Size (Bytes)

The compressed size of the file, in bytes.

File Editor

Using the file editor, you can edit text files on the router.

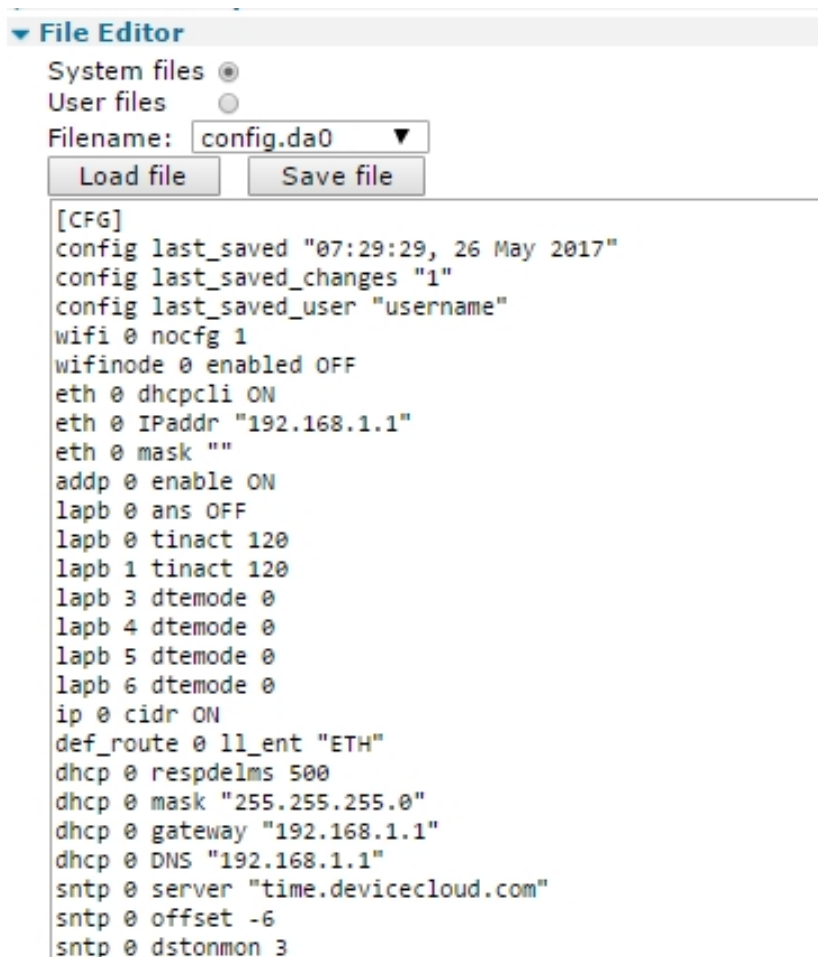

Filename

The name of the file to edit. In this field, you can create a new file by typing in the filename and clicking on the **Save File** button.

Load File

Load the file specified in the **Filename** field into the editor box.

Save File

Save the file to the flash file system.

Command line

copy command: Copy a file

The **copy** command makes a copy of a file. The format is:

```
copy <filename> <newfilename>
```

Where:

<filename>

The name of an existing file.

<newfilename>

The name of the new copy that will be created.

del command: Delete a file

The **del** command deletes files from the filing system. The format is:

```
del <filename>
```

<filename>

The name of an existing file.

You can also use wild cards in the filename in order to delete several files at once. The * character can represent one or more characters in the filename. For example, **del fw*.txt** will delete files **fw.txt** and **fwstat.txt**. The **del** command returns **OK** if files have been deleted, or **ERROR** if no matching files have been found.

dir command: List the file directory

The **dir** command displays the file directory. There are several command variants:

Command	Options	Equivalent web parameter
dir		Displays the entire contents of the router’s flash file system.
dir	<filter>	Displays a filtered view of the router’s flash file system. The filter can contain wildcards using the *. such as dir *.pem to display all the files ending in .pem .
dir	u:	Displays the contents of an USB flash stick if inserted into the USB port of the router.

For example:

```
dir
  direct    60720 ro   11:30:41, 31 Jan 2011 CRC   ???
  sbios     524288 ro   11:30:43, 31 Jan 2011 CRC  6ba8
  mirror    60720 ro   11:30:41, 31 Jan 2011 CRC   ???
  image     4300995 rw   15:22:23, 31 Jan 2011 CRC  ab19
  sregs.dat  4096 rw    11:30:41, 31 Jan 2011 CRC  08b2
  x3prof    4096 rw    11:30:41, 31 Jan 2011 CRC  bb5f
  CAcert.cer 1371 rw    11:30:41, 31 Jan 2011 CRC  6764
```

Each line shows:

- The file name and extension, if any
- The file size, in bytes

- The read/write status: **ro**=read only; **rw**=read/write
- The time/date of creation and the CRC value

Note File write operations are carried out as a background task and can be relatively slow due to the constraints of FLASH memory. As a result, the file directory may only be updated several seconds after a particular file operation has been carried out.

You can also use wildcards with the `dir` command in order to narrow your search. The `*` character can represent one or more characters in the filename. For example, `dir fw*.txt` will list only the `fw.txt` and `fwstat.txt` files, if they are present on the TransPort.

fattr command: Set or remove read only flag for a file

The **fattr** command adds or removes a read only flag for a file. Add a read only flag to set the file access permission to read only. Remove the read only flag to set the file access permission to read/write.



WARNING! Changing access permission for a system file can cause unexpected and undesired changes in system behavior. Do not use the **fattr** command to change access permissions on system files.

To set the file access permission to read/write, remove the read only flag for a file:

```
fattr -r <filename>
```

To set the access permission for a file to read only, add the read only flag for a file:

```
fattr +r <filename>
```

flock command: Lock files

The **flock** command prevents any further writing to the FLASH memory. This means that no files can be written to, added to or deleted from the filing system.

funlock command: Unlock files

The **funlock** command unlocks the FLASH memory if it had been locked using the `flock` command. Files can then be added, deleted, or copied to the filing system.

move command: Move a file

The **move** command replaces one file with another while retaining the original filename. The format is:

```
move <fromfile> <tofile>
```

For example, this command deletes the file called `fw.txt` and then rename the file called `fw-temp.txt` as `fw.txt`:

```
move fw-temp.txt fw.txt
```

ren command: Rename a file

The **ren** command renames files in the filing system. The format is:

```
ren <oldfilename> <newfilename>
```

scan/scanr command: Scan the file system

The **scan** command performs a diagnostic check on the file system and reports any errors. For example:

```
scan
Please wait...
  direct ....ok
  sbios ....ok
  mirror ....ok
  image ....ok, data ok
  sregs.dat ....ok
  x3prof ....ok
  CAcert.cer ....ok
```

The scanning process may take several seconds so you should not enter any other commands until the results are listed.

The **scanr** command works in a similar fashion, except that it returns **ERROR** if any file is in error. This is useful when using scripts that can look for the **ERROR** failure result.

type command: Display a text file

The **type** command displays the contents of a text file. The format is:

```
type <filename>
```

For example:

```
type config.da0
[CFG]
config last_saved "12:04:45, 31 Jan 2011"
config last_saved_changes "1"
config last_saved_user "ASY 0"
eth 0 descr "LAN 0"
eth 0 IPaddr "10.1.51.3"
eth 0 mask "255.255.0.0"
eth 0 bridge ON
eth 1 descr "LAN 1"
eth 2 descr "LAN 2"
eth 3 descr "LAN 3"
eth 4 descr "ATM PVC 0"
```

xmodem command: Initiate an XMODEM file upload

The **xmodem** command initiates an XMODEM file upload from the port at which the command is entered. The format is:

```
xmodem <filename>
```

Where:

<filename>

The name under which the file will be saved when the upload is complete.

After you enter the **xmodem** command, the router waits for your terminal program to start transmitting the file. When the upload is complete and the file has been saved, the router responds with the **OK** result code.

To initiate a remote XMODEM upload, establish a Telnet session over ISDN, and then issue the **xmodem** command from the remote terminal.

TransPort file system

A typical TransPort file directory includes the following files:

Filename	Description
ana.txt	Pseudo file for Protocol Analyser output
config.da0	Data file containing Config.0 settings
direct	File directory
eventlog.txt	Pseudo file for Event Log output
fw.txt	Firewall script file
fwstat.txt	Firewall script status file
image	Main system image
*.web	File containing compressed Web pages for your model
logcodes.txt	Text file containing Event Log config. info.
pwds.da0	File containing obfuscated passwords
sbios	TransPort BIOS and bootloader
sregs.dat	Data file containing AT command & S register settings
x3prof	X.25 PAD profile parameters

Once you have configured the router, you must save the chosen settings to non-volatile memory to avoid losing them when the power is removed.

- Application command settings are stored in one of two **CONFIG** files.
- AT command and S register settings are stored in one file named **SREGS.DAT**.

Configuration files

Most configuration information is stored in one of two files called **config.da0** and **config.da1**. This allows two different sets of configuration information to be stored using the **Save** option in the directory tree at the left of the web interface, or by using the **config** command from the command line.

The **Save All** button saves the following files:

File name	Configuration held in file
config.da0	Main configuration parameters
pwds.da0	Encrypted passwords
fw.txt	Firewall rules
sregs.dat	Serial port S registers
x3prof	X.25 PAD profiles

You can select which of the two config files is loaded when the router is powered-up or rebooted by setting the **Use Config n** parameter on the **Configuration > System > General > Miscellaneous** page when the router powers up as required, or by using the **config n powerup** CLI command.

Note The **config.da0** and **config.da1** files only contain details of settings that have been changed from the default values.

***sregs.dat* file**

A combined set of AT command and S register settings are called a profile. Two such profiles, profile **0** and profile **1**, can be stored for each **ASY** port in a file called **sregs.dat**. To save the file, use the **Save Profile** button on the relevant Configuration > Network > Interfaces > Serial > Serial Port n web page, or use the **AT&W** command.

Saving the settings for one ASY port does not save the settings for the other ports. You must save the settings for each port individually.

For each ASY port, the profile to be loaded at reboot or power-up is specified in the **Power-up Profile** setting on the relevant **Configuration > Network > Interfaces > Serial > Serial Port 0** web page, or use the **AT&Y** command).

You can load a profile for a particular **ASY** port to take immediate effect, using the **Load Profile** button on the ASY port's web page, the **ATZ** command.

***pwds.da0* file**

As of firmware version **4981**, the encrypted forms of passwords entered into the configuration are stored in a separate file named **pwds.da0**. This file can only be accessed by users with **Super** level privileges. The file can be read with the type command, such as, type **pwds.da0**.

The **pwds.da0** file is only created when a password is changed from default and the configuration is saved. The router then removes encrypted versions of the default passwords from the **config.da0** file and instead creates and uses a new **pwds.da0** file.

If you delete a **pwds.da0** file, all remote access to the router that requires authentication will fail. In such a case, you will need a serial cable connection to re-configure passwords to gain access to the router. If both the **pwds.da0** file exists and the **config.da0** contains passwords also, the passwords in the **config.da0** take precedence and overwrite the passwords in the **pwds.da0** when a **save** command is issued.

Manage files using USB storage devices

Most TransPort routers are equipped with USB ports that you can use to connect Mass Storage Devices (MSDs) such as external hard drives or flash-memory pen drives. All the files on the USB device are listed under the **USB Directory Listing** heading on the **Administration > File Management > FLASH Directory** page.

The USB storage device must be formatted using the FAT16 or FAT32 file system.



WARNING! For the TransPort WR31, the USB port is for use in a normal location only, not a hazardous location.

When the USB storage device is first inserted into the router, the operating system looks for a file named **autoexec.bat**, and if found, executes it. To execute other batch files, press the Reset button one or more times. The batch file to execute must be called **pb<n>.bat**, where **<n>** is the number of times the Reset button must be pressed to execute the file.

SD memory card support

Some TransPort routers are available with internal SD memory card. The drive letter assigned to this card is **s:**. To access the SD memory using an FTP client, the subdirectory assigned is **sdmnc**. You can use the SD card in the same way as USB MSDs. The SD card is internal and cannot be removed.

Batch control commands

Batch files can contain one of the following two control lines: **ERROR_EXIT** or **ERROR_RUN**. **ERROR_EXIT** causes any commands run after that point in the file to terminate the batch file if that command causes an error; for example, attempting to delete a file that does not exist. **ERROR_RUN** returns the operation to default, which is to continue executing batch file commands.

Use USB filing system commands

Command line

The USB storage device responds to any of the standard filing system commands. For all filing system commands, the USB storage device is regarded as drive **u:**.

Note The router does not support subdirectories. Any subdirectories on the USB device display with a size of **0 bytes** on the **Administration > File Management > FLASH Directory** page.

Display contents of the USB storage device

Enter the command:

```
dir u:
SERIALS.TXT 1843
EVENTL~1.TXT 1449
USB.TXT 4278
MASSR1~1.TXT 1255
OK
```

If the USB storage device is empty, the following message is displayed:

```
No files
```

If no USB device is present, the following message is displayed:

```
No USB flash directory
```

Copy a file

To copy a file named **image** from the main flash memory onto the USB device, enter the command:

```
copy image u:image
```

To copy a file named **Logcodes.TXT** from the USB device to the main flash memory, enter the command:

```
copy u:Logcodes.TXT Logcodes.TXT
```

or

```
copy u:Logcodes.TXT
```

If no destination file is specified, the destination is set to the FLASH directory and the file name remains the same.

Use a USB device to upgrade firmware

The following functionality is available from firmware version 4891 onwards.

The TransPort firmware can be upgraded using the USB storage device. To perform an upgrade:

1. Create a simple batch file named **pb2.bat**.
2. Place the relevant firmware upgrade files into the **root** directory of the USB storage device.
3. Insert the USB device into the TransPort router.
4. Press the router's reset button twice. The firmware upgrade will begin. You will see output similar to the following:

```
ERROR_EXIT
del *.web
copy u:sbios1 sbios1
copy u:logcodes.txt logcodes.txt
copy u:image image
copy u:image4.c3 image4.c3
copy u:Y4890wVS.web Y4890wVS.web
move sbios1 sbios
scanr
flashleds
```

5. When the LEDs on the TransPort start flashing, the upgrade is complete.
6. Reboot the TransPort router to activate the new firmware.

Use USB devices with .all files

The following functionality is available from firmware version 4910 onwards.

A **.all** file is a special file that contains all of the firmware and configuration files in a single file that has the file extension **.all** and is an exact copy of the TransPort router in its current state. This **.all** file can then be applied to another TransPort router, as long as it is the same model.

1. To extract a **.all** file, use the Digi Flash Writer software.
2. Copy the extracted **.all** file to a USB storage device and insert the device into the TransPort router.
3. Issue the command **dir u:** to confirm that the TransPort can access the USB device.
4. To copy the **.all** file onto the TransPort router, from the command line enter this **copy** command:

```
copy u:mr4110.all t.all
```

Replace **mr4110.all** with the correct **.all** file name. The **t.all** destination name can be any destination. The source file (in this example, **mr4110.all**) must adhere to the 8.3 filename convention, owing to limits of the FAT file system, or the process will fail.

Prevent unauthorized access from a USB storage device

You can prevent unauthorized access to a TransPort router using a USB storage device, such as inserting a USB storage device with an **autoexec.bat** file designed to copy usernames and passwords, etc. Several commands prevent unauthorized access via the USB port:

Command line

1. Use the **usbcon** command to define an access key. If the **.bat** file does not contain the matching key, it will not be allowed to execute.
2. Use the **uflash** command's **put** parameter to encode the matching key onto the file.

Note When using the **uflash** command, do not prefix the filename with **u:** as the **uflash** command can only act on files stored on a USB storage device.

For example:

- Create a key:

```
usbcon 0 flashkey
```

- Encode this key onto a file called **autoexec.bat** on the USB storage device:

```
uflash autoexec.bat put
```

- Remove a key from a file using the **uflash** command parameter **clr**:

```
uflash autoexec.bat clr
```

Note To use the **uflash** command, you must be logged onto the router with **Super** access level.

Execute alternate batch files when a USB drive is inserted

By default, an **autoexec.bat** file executes when a USB drive is inserted. You can execute other batch files. To control this behavior, enter:

```
>usbcon 0 batfile <off|on>
```

Disable or enable the USB ports

If required, you can disable the external USB ports. Disabling the USB ports prevents any unauthorized copying of files to or from the router, or unauthorized use of flash drives or serial devices connected to the USB ports.

Command line

To disable the USB ports, use the **usbcon** command. The parameters to use on the **usbcon** command are:

dislist

Disables the USB port.

enalist

Explicitly enables a list of USB drivers. The driver list can be comma-separated to specify more than one driver if required.

The format of the **usbcon** command to disable the USB port is:

```
usbcon 0 usb-x-p<.p>.<DRIVER>
```

Where:

- **x=1** for the bottom USB port and 2 for the top port.
- **p=<port #>** (if connected to a USB hub the port numbers can increase).
- **DRIVER=MSD** for Mass Storage Device, **SERIAL** for serial devices, or **HUB** for hub devices.

For example:

- Disable a Flash stick on the top port only:

```
usbcon 0 dislist usb-2-2.MSD
```

- Use wildcards to disable flash devices entirely:

```
usbcon 0 dislist usb-*.MSD
```

This will match on ALL MSD devices even if in another HUB.

- Disable both external USB ports on a DR64x0, enter the following commands:

```
usbcon 0 dislist "usb-1-2*,usb-2-2*"
```

or

```
usbcon 0 dislist "usb-?-2*"
```

The final **-2** is important in both cases. Otherwise, the command disables the internal USB devices, which could include connections to the wireless module or other components.

- To disable serial devices from using either external USB port on a DR64x0, or on a port connected to a hub on either these ports:

```
usbcon 0 dislist "usb-1-2*.SERIAL,usb-2-2*.SERIAL"
```

or

```
usbcon 0 dislist usb-?-2*.SERIAL
```

- The **enalist** takes the same format, but when matches occur, it enables the device. If a device matches the enable list as well as the disable list, the enable list takes preference. When a device matches a list an event is written to the event log of the form:

```
"USB device usb-1-2.4.MSD disabled"
```

or, if the device matches the **enalist**:

```
USB device usb-1-2.4.MSD enabled"
```

- You can use these events to debug the correct matching string to match on when trying to configure these parameters.
- If both lists are left blank, all drivers are enabled and no extra events appear in the event log.

Create a universal config.da0 file using tags

The **config.da0** contains a list of commands, one per line that are parsed at boot. The commands in this file differ, depending on the model of the router, the firmware in use and the hardware options installed.

You can create a single universal configuration file using tags, defining sections that only relate to a specific hardware type or firmware version.

The tag values you can use are:

- The base model, for example: **DR6410**
- The complete model, for example: **DR6410-H0A**
- The platform build string, for example: **8W**
- The type of DSL, for example: **DSL2, 2+**
- The type of WWAN module detected, for example: **E** (Edge), **C** (CDMA)
- The complete WWAN module string, for example: **MOTO_G24SIEMENS_GPRS, SIEMENS_MC75, NOVATEL_3G, SIERRA_3G, OPTION_3G, NOVATEL_CDMA, CMOTECH_CDMA, SIERRA_CDMA**
- PSTN or ISDN module, for example: **PSTN, ISDN**

Enclose the tags within angle brackets. Open and close the configuration sections with the relevant tag. For example, to open: **<DR6410>**

To close: **</DR6410>**

Note use of the **/** in the closing tag.

To view a list of defined tags on a router, use the command **tags**. Here is example output of the **tags** command:

```
Router>tags
tags defined:..
TransPort
DR64
dr6410
8W
OPTION_3G
ISDN
DSL
61690
OK
```

Example scenario

Suppose a single configuration file is required for a range of DR6410 routers. There is a mix of three types of 3G WWAN modules and some have GPRS modules installed. Different W-WAN modules need different modemcc commands to correctly configure the **ASY** ports. All these modules can have their own specific commands in one config file.

Use comments in configuration files

You can use comments in configuration files to make them easier to read. The shaded comments are prefixed with a # symbol. In the example below, the **info_asy_add** parameters are for illustration purposes only and are not the actual ASY port numbers in use.

```
<DR6410-H0A>
#Start of DR6410-H0A config
<NOVATEL_3G>
#Start of Novatel specific config
modemcc 0 asy_add 7
modemcc 0 info_asy_add 8
#End of Novatel specific config
</NOVATEL_3G>
<OPTION_3G>
#Start of Option specific config
modemcc 0 asy_add 7
modemcc 0 info_asy_add 9
#End of Option specific config
</OPTION_3G>
<SIERRA_3G>
#Start of Sierra specific config
modemcc 0 asy_add 7
modemcc 0 info_asy_add 10
#End of Sierra specific config
</SIERRA_3G>

#End of DR6410-H0A config
</DR6410-H0A>
<DR6410-E0A>
#Start of DR6410-E0A config
modemcc 0 asy_add 7
modemcc 0 info_asy_add 11
#End of DR6410-E0A config
</DR6410-E0A>
#Rest of generic config goes below here
modemcc 0 apn internet"
eth 0 ipaddr 192.168.0.99
```

Manage X.509 certificates and host key pairs

The X.509 Certificate Management pages are for loading and managing X.509 certificates and public/private host key pairs that are public key infrastructure (PKI) based security.

Manage Certificate Authorities (CAs)

A certificate authority (CA) is a trusted third party that issues digital certificates for use by other parties. digital certificates issued by the CA contain a public key.

The certificate also contains information about the individual or organization to which the public key belongs.

A CA verifies digital certificate applicant’s credentials.

The CA certificate allows verification of digital certificates and the information contained therein, issued by that CA.

Web

Go to **Administration > X.509 Certificate Management > Certificate Authorities**.

Installed Certificate Authority Certificates

Installed Certificate Authority Certificates

Subject	Issuer	Expiration	Filename	
Digi International Server CA	Digi International Server CA	May 13 16:32:25 2111 GMT	cadc.pem	<input type="button" value="View"/> <input type="button" value="Delete"/>

This table lists the current CA certificates that have been installed onto the router. Use the **View** button to view the contents of each certificate.

Upload CA Certificates

Upload CA Certificates

Upload certificate authority (CA) certificates. Files may be in ASN.1 DER or PEM Base64 encoded formats.

Upload File: No file chosen

Use the **Choose File** and **Upload** buttons to upload CA Certificates from a host PC onto the router.

Obtain CA certificates from a SCEP Server

The Simple Certificate Enrollment Protocol (SCEP) allows the user to request and enroll CA certificates from a CA server.

The CA certificate files are automatically stored with the name **CA<n>.pem**, where **n** increments with each certificate.

SCEP Server IP address

The IP address of the SCEP server/CA server.

Port

The port on which SCEP server is listening. If the port is **0**, the router uses default port of **80**.

Path

The path on the server to the SCEP application. The path can either be entered manually if known, or select from **cgi-bin** or **Microsoft SCEP** from the drop-down list.

Application

The SCEP application running on the server.

CA identifier

The identifier for the CA server. The CA identifier to use to identify a particular CA when multiple CAs might be running on the server.

 **Command line**

Command	Instance	Parameter	Values	Equivalent web parameter
scep	0	host	IP Address	SCEP Server IP address
scep	0	port	0-65535	Port
scep	0	path	String	Path
scep	0	app	String	Application
scep	0	caident	String	CA Identifier

Manage IPsec/SSH/HTTPS certificates

The **IPsec/SSH/HTTPS certificates** page contains fields that required when sending a certificate request to a Certificate Authority (CA).

This information forms part of the certificate request, and thus part of the signed public key certificate.

The router can use certificates to establish IPsec tunnels with other routers and support SSH and HTTPS connections. For more information on using certificates with the router,

See [Application Note 22, IPsec VPN tunnel between two Digi Routers using Certificates and SCEP](#).

Web

Go to **Administration > X.509 Certificate Management > IPsec/SSH/HTTPS Certificates**.

Installed certificates

This table lists the current certificates that have been installed onto the router. It is possible to view the contents of each certificate using the **View** button.

Installed Certificates

Subject	Issuer	Expiration	Key Size	Filename		
		Mar 22 15:36:06 2025 GMT	2048	cert01.pem	<input type="button" value="View"/>	<input type="button" value="Delete"/>

Upload certificate or private keys

In the **Upload Certificate or Private Keys** section, you can upload certificates and private key files from a host PC onto the router using the **Choose File** and **Upload** buttons.

Upload Certificate or Private Keys

Upload RSA keys and certificates. Certificate and key files may be in ASN.1 DER or PEM Base64 encoded formats.

Upload File: No file chosen

Create, enroll, and install certificate requests

The **Enrollment** section of the page has parameters to create a certificate request, enroll the certificate, and install the certificates on the router.

Enrollment

Automatically re-enroll aging certificates

SCEP Server IP address: Port:

Path: ▼

Application:

CA identifier:

CA certificate: ▼

CA encryption certificate: ▼

CA signature certificate: ▼

RSA Private Key: Use Existing Key
 Generate new key with size bits

Private key filename: ▼

Enrollment Password:

Common Name (CN):

Country Code (C):

State or Province (ST):

Locality (L):

Organisation (O):

Organisational unit (OU):

E-mail:

Unstructured name: (Optional)

Digest Algorithm: ▼

Ignore NONCE in SCEP response

Automatically re-enroll aging certificates

Select to make sure any aging certificates are re-enrolled.

SCEP Server IP address

The IP address of the SCEP server / CA server.

Port

The port on which the SCEP server is listening. If the port is **0**, the router uses the default port of **80**.

Path

The path on the server to the SCEP application. You can either enter your own path or select from cgi-bin or Microsoft SCEP from the drop-down list.

Application

The SCEP application running on the server.

CA identifier

The identifier for the CA server. The CA identifier to use to identify a particular CA when multiple CAs might be running on the server.

CA certificate

The filename of the CA certificate.

CA encryption certificate

Sometimes when you get a CA certificate, a CA encryption certificate is installed on the router at the same time. You can identify a CA encryption certificate by looking at the **X.509 Key Usage** section in the certificate. It should display something like the following:

```
X509v3 Key Usage: critical
                Key Encipherment, Data Encipherment
```

If a CA encryption certificate has been installed by the CA you wish to use for the certificate request, enter the CA encryption certificate. If no CA encryption certificate has been installed for the CA, leave this file blank.

CA signature certificate

Sometimes when you get a CA certificate, a CA signature certificate is installed on the router at the same time. You can identify a CA signature certificate by looking at the **X.509 Key Usage** section in the certificate. It should say something like the following

```
X509v3 Key Usage: critical
                Digital Signature, Non Repudiation
```

If a CA signature certificate has been installed by the CA you wish to use for the certificate request, enter the CA signature certificate. If no CA signature certificate has been installed for the CA, leave this file blank.

RSA Private key

Selects either using an existing private key or generating a private key for each certificate request.

Private key filename

The filename of the private key file to use.

Enrollment Password

Before you can create a certificate request you must first obtain a challenge password from the Certificate Authority Server. This password is generally obtained from the SCEP CA server by way of a WEB server or a phone call to the CA Server Administrator. For the Microsoft® SCEP server, you browse to a web interface. If the server requires a challenge password, it will be displayed on the page along with the CA certificate fingerprint. This challenge password is usually only valid once and for a short period of time, in this case 60 minutes, meaning a certificate request must be created after retrieving the challenge password.

Common Name (CN)

A name for the router. This parameter is important, as the router will use the common name as the router's ID for IKE negotiations.

Country Code (C)

The two-character county code of where the router is located. A list of valid country codes can be found at http://www.iso.org/iso/english_country_names_and_code_elements.

State or Province (ST)

The state, county, or province of where the router is located.

Locality (L)

The town or city of where the router is located.

Organisation (O)

The company to whom the router belongs to.

Organisational unit (OU)

The company department maintaining the router.

E-mail

An appropriate email address of a contact for the router.

Unstructured name

This parameter is optional. It can contain some descriptive to help identify the certificate.

Digest Algorithm

The digest algorithm (MD5 or SHA1) when signing the certificate request.

Ignore NONCE in SCEP response

The parameter instructs the router to ignore the **NONCE** field in the SCEP response. Use the **NONCE** field to prevent replay attacks.

Enroll button

Sends the enrollment request to the SCEP server.

 **Command line**

Command	Instance	Parameter	Values	Equivalent web parameter
scep	0	host	IP Address	SCEP Server IP address
scep	0	port	0-65535	Port
scep	0	path	String	Path
scep	0	app	String	Application
scep	0	caident	String	CA Identifier
scep	0	cafile	Filename	CA certificate
scep	0	caencfile	Filename	CA encryption certificate
scep	0	casigfile	Filename	CA signature certificate
creq	0	challenge_pwd	String	Enrolment Password
creq	0	commonname	String	Common Name (CN)
creq	0	country	String	Country Code (C)
creq	0	state	String	State or Province (ST)

Command	Instance	Parameter	Values	Equivalent web parameter
creq	0	locality	String	Locality (L)
creq	0	orgname	String	Organisation (O)
creq	0	org_unit	String	Organisational Unit (OU)
creq	0	email	Email Address	E-Mail
creq	0	unstructname	String	Unstructured Name
creq	0	digest	MD5 or SHA1	Digest Algorithm

creq command

Use the **creq** command to generate the certificate request using the configured parameters. If the private key does not already exist and you enter the appropriate parameters, the private key is generated at the same time.

To generate a certificate request, enter:

```
creq new -k<priv key file> -o<cert request file>
```

To generate a private key and a certificate request, enter:

```
creq new -b<priv key length> -k<priv key file> -o<cert req file>
```

To generate a certificate request file called **request.pem** from a private key called **priv001.pem**, enter:

```
creq new -kpriv001.pem -o request.pem
```

To generate a 512-bit private key named **private.pem**, and a certificate request named **certreq.pem** using that file, enter:

```
creq new -b512 -kprivate.pem -ocertreq.pem
```

Manage RSA key files

Web

1. Go to **Administration > X.509 Certificate Management > Key files**.
2. Use the **Choose File** button to browse for and select the RSA key file to upload, or enter the filename in the **Filename** field.
3. Enter the passphrase for the RSA key file in the **Passphrase** and **Confirm Passphrase** fields.
4. Click **Upload**.

Generate private keys

You must create a private key before a certificate can be requested, as the request uses this private key.

Web

Go to **Administration > X.509 Certificate Management > Key Generation**.

The **Key Generation** settings generate a private key. Fields in this section are as follows:

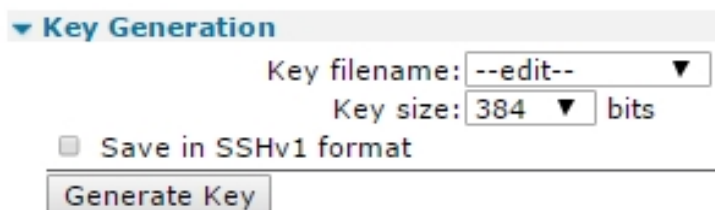

Key filename

A name for the private key. The filename must be prefixed with **priv** and have a **.pem** extension.

Key size

The size of the private key, in bits. The larger the key, the more secure the connection. But also, the larger the key, the slower the connection. The key size can be one of the following: **384, 512, 768, 1024, 1536, 2048**.

Save in SSHv1 format

If enabled, generates the private key in SSH version 1 format. If disabled, generates the private key in SSH version 2 format.

Generate Key button

Generates the private key.

Command line

Use the **genkey** command to generate a private key file.

```
genkey 0 <keysize> <filename> <-ssh1>
```

where:

- **<keysize>** is the size of the key in bits.
- **<filename>** is the name of the private key file.
- **<-ssh1>** is optional, and will generate the private key file in SSH version 1 format.

Note IPsec requires SSH version 2 private keys.

For example, to generate a **1024**-bit SSH version 2 key called **privkey.pem**, enter:

```
genkey 1024 privkey.pem
```

Command output is:

```
OK
Starting 1024 bit key generation. Please wait. This may take some time...
Key generated, saving to FLASH file privkey.pem
Closing file
Private key file created
All tasks completed
```

Split a private key

For increased security, you can split the private key file between the router flash and an USB memory stick. Once a private key has been split and stored in two parts, the USB memory stick must be present for any successful IKE negotiations that involve the private key. Because the USB memory stick only contains a part of the private key, you cannot use it in another router. For more information on using a USB memory stick, see [Manage files using USB storage devices](#).



Command line

The command to split a private key is:

```
privsplit <certificate filename>
```

Back up and restore configuration settings

There are several mechanisms available to backup device configurations, and later restore them on your TransPort router. It is important to understand the Digi TransPort file system and which files should be backed up.

Configuration files associated with your TransPort router

The TransPort router file system includes several configuration files:

File name	Purpose and contents
config.da0	Primary configuration file. This is where all feature configuration settings are written when a configuration is saved. You can also use the file named config.da1 to create and save an alternate configuration.
pwds.da0	Obfuscated passwords file.
fw.txt	Firewall rules.
sregs.dat	Serial port configuration settings, if the serial settings were changed from their defaults.
x3prof	X.25 PAD profile. Rarely used.
logcodes.dif	Event handler logcodes updates; may or may not be present.

For more information on these and other TransPort configuration and data files, see [TransPort file system](#).

Methods for saving configuration files

You can save these files in several ways:

- From the web interface: Go to **Administration > Backup/Restore**. All selected files are stored in Zip format for easy storage and restoration to this same or different unit.
- FTP the files to a file using an FTP client.
- Save the files from the web interface: Go to **Administration > File Management > FLASH directory**.
- Copy the files to a USB storage device (U:)
- Use a remote management platform such as Digi Remote Manager, which can save configurations, restore them, and do other system maintenance on scheduled basis.

Web

Backup and restore are available in the web interface only.

Back up the configuration to a file on your PC or a server

1. Go to **Administration > Backup/Restore**.
2. Select optional information to include in the backup file: passwords, CA certificates, certificates and keys, the MySQL database file, routing protocol configuration files, debug.txt file.
3. Click **Backup**.

Restore the configuration to a file on your PC or a server

1. Go to **Administration > Backup/Restore**.
2. Select the file from which the settings should be restored.
3. Click **Restore**.

Update firmware

The **Administration > Update Firmware** page updates firmware. During the firmware update process, the router downloads a **.zip** file onto the router, uncompresses it, validates each file within the zip file, then updates the files in its flash file system.

The **.zip** file containing the latest firmware version is available from the Digi website (<http://transport.digi.com/digi/firmware/ftp/>).

Web

Firmware update is available in the web interface only.

1. Download the **.zip** file to your PC before starting the firmware update. The Update Firmware web page has a link for doing so.
2. Go to **Administration > Update Firmware**.

Administration - Update Firmware

You can obtain the latest firmware ZIP file for this unit from the Digi website [here](#).
 Model: TransPort WR44v2
 Firmware Version: 5.2.18.3

Select Firmware

Select Firmware: No file chosen

Do not navigate away from this page while the update is in progress.

Model

The model of the router.

Firmware Version

The current firmware version running on the router.

3. Click the **Choose File** button to browse for and select the **.zip** file on your PC containing the firmware version to which you wish to update.
4. Click **Update**. The firmware update begins.



CAUTION! Do not remove the power from the router while an update is in progress, as it can corrupt the router's flash file system and might leave the router unable to boot up.

Do not navigate away from the **Update Firmware** page while an update is in progress,



as that action can cause the update to abort prematurely.

5. Once the firmware update is complete, reboot the router.

Reset the router to factory defaults

Using the web interface

Web

1. Go to **Administration > Factory Default Settings**.

Administration - Factory Default Settings

Caution: Restoring the factory default settings will clear all current settings and automatically reboot the unit.

Keep network settings

2. (Optional) Select **Keep network settings option** to preserve certain network settings after the reset, including:
 - Ethernet 0 IP address
 - Ethernet 0 Mask
 - Ethernet 0 Gateway
 - Ethernet 0 DHCP Client
 - Ethernet 0 DNS Server
 - Default Route 0 Interface
 - PPP 1 Username
 - PPP 1 Password
 - PPP 3 Username
 - PPP 3 Password
 - Mobile APN
 - Mobile SIM PIN
3. Click **Restore**.



CAUTION! To avoid corrupting flash memory, do not remove power from the router during this operation.

4. Click **Reboot** to reboot the router.

Using the reset button on the router

Most TransPort routers have a reset button.

- **TransPort WR11:** The reset button is on the far right of the front side panel. See [TransPort WR11 hardware features](#).
- **TransPort WR21:** The reset button is on the front panel, to the right of the **Signal** LEDs. See [TransPort WR21 hardware features](#).
- **TransPort WR31:** The reset button is above the USB connector. See [TransPort WR31 hardware features](#).
- **TransPort WR41:** The reset button is on the underside of the unit. See [TransPort WR41 hardware features](#).
- **TransPort WR44:** The reset button is on the underside of the unit. See [TransPort WR44 / WR44 R hardware features](#).
- **TransPort WR44 RR** does not have a physical reset button.

To reset the router to factory defaults:

1. If the router is not already on, turn the router on and wait **15** seconds for the router to complete its initialization process.
2. Press and hold the reset button for **5** seconds. The router's LEDs will flash to indicate a factory reset is in progress. Once the reset is complete, the router automatically reboots.



CAUTION! To avoid corrupting flash memory, do not remove power from the router during this operation.

Save configuration settings to a file

Once you have configured the router, save the settings to non-volatile memory to avoid losing them when the power is removed.

You have two choices on saving configuration settings: saving the current configuration or saving the router's entire configuration.

Save the current configuration

The **Save** button in the web interface and the **config** command save the current configuration to the specified configuration file, **config.da0** or **config.da1**. The default power-up configuration profile is **profile 0**. The extension ***.da0** indicates that the configuration profile in use is **profile 0**. An extension of ***.da1** indicates that configuration **profile 1** is in use. Not every configuration setting is saved, however. See the Save All option.

Save All: Save the entire configuration

The **Save All** button in the web interface and **saveall** command save the router's entire configuration. This operation performs the following actions:

- Saves the current configuration parameters to the file **config.da0** or **config.da1**. The default power-up configuration profile is **profile 0**. The extension ***.da0** indicates that the configuration profile in use is **profile 0**. An extension of ***.da1** indicates that configuration **profile 1** is in use.
- Saves the ciphered versions of the passwords to the file **pwds.da0** or **pwds.da1** file**.
- Saves the firewall configuration to the file **fw.txt**.
- Saves the serial port configuration to **profile0** of the **sregs.dat**.
- Saves the PAD parameters on all the PADs to **profile 0** of the file **x3prof**.

Web

1. Go to **Administration - Save configuration**.

[Administration - Save configuration](#)

Save current configuration to Config

Save all configuration. This includes the following

- Save the current configuration to config 0
- Save the current firewall
- Save all sregisters on all ports to profile 0
- Save all PAD parameters on all PADs to profile 0

2. Select the configuration file to which the current configuration will be saved when the **Save** button is clicked. There are two options: **profile 0** and **profile 1**. The configuration profile in use when the router powers up is indicated in the selection box. The default power-up profile is **profile 0**.
3. Click **Save** or **Save All**.

 **Command line**

Parameter	Options	Equivalent web parameter
config	save	Save current configuration to Config n
saveall	n/a	Save all configuration

Execute a command from the web interface

Web

1. To enter TransPort CLI commands from the web interface, go to **Administration > Execute a Command**.

A majority of the commands mentioned in this User Guide can be entered using this feature.

2. Enter the command name and click **Execute**.

The command output displays, for example:



Administration - Execute a command

Command:

Command: uptime
Command result

Uptime 3 Hrs 34 Mins 45 Seconds
OK

Reboot the router

You can reboot the router immediately or at a scheduled time.

The router performs a reboot after any FLASH write operations are completed. There is an allowance of one second each for the following operations to be completed before reboot will occur:

- Create and send IPSec SA delete notifications are created and sent
- Close TCP sockets
- Disconnect PPP interfaces

Note To schedule reboots on a recurring basis, use Digi Remote Manager's device tasks feature and its schedule options. See the [Digi Remote Manager User Guide](#).

Web

1. Go to **Administration > Reboot**.

Administration - Reboot

Rebooting the unit will take a minute. Remember to [save the configuration](#) if necessary before rebooting.

Immediately
 In hrs mins secs

2. Enter the reboot options:

Immediately

Causes the router to reboot after a few seconds. The router cleanly terminates any TCP and VPN connections before rebooting.

In h hrs m mins s secs

Schedules a reboot to occur after the configured period of time. To cancel a scheduled reboot, enter the **reboot cancel** command from the command line.

3. Click **Reboot** to reboot the router or set the scheduled reboot to occur.

Command line

Command	Options	Equivalent web parameter
reboot	n/a	Immediately
reboot	0-86400	In h hrs m mins s secs. This CLI value is entered in minutes only.
reboot	cancel	Cancel reboot

Troubleshooting

Troubleshooting resources	942
Download the debug.txt file	943
Cannot open the web interface	945
Cannot log into the web interface	946
Troubleshoot the LTE-MIMO antenna orientation	947
Network start verbose call end reasons	947

Troubleshooting resources

There are several resources available to you for support of your Digi product or resolving configuration difficulties at [Digi Support site](#). On this site, you can access Digi's support knowledge base and other support documents.

If the knowledge base or support forums do not have the information, make an online support request at [Digi's Support site](#). You will need to create a user account if one is not already set up.

When submitting a support request, include a copy of the **debug.txt** file from the device's flash. This will greatly improve the quality of the initial response you receive. It will help the Digi Support team to provide accurate answers to your queries.

Download the debug.txt file

To download the **debug.txt** file from your Digi TransPort device:

1. Browse to the router's IP address to connect to the web interface.
2. Navigate to **Administration > File Management > FLASH Directory**.
3. Scroll to the **debug.txt** file. It is usually near the end of the file list.
4. Right-click on **debug.txt** and choose the available option on your operating system to save the file, such as **Save link as**.

Administration - File Management > FLASH Directory

<input type="checkbox"/>	car_7455.txt	136 bytes	rw	09:41:15, 23 May 2017
<input type="checkbox"/>	config.da0	2052 bytes	rw	07:28:32, 26 May 2017
	config.fac	16655 bytes	ro	09:41:15, 23 May 2017
<input type="checkbox"/>	fw.txt	762 bytes	rw	09:41:15, 23 May 2017
	fw.fac	762 bytes	ro	09:41:15, 23 May 2017
<input type="checkbox"/>	x3prof	4096 bytes	rw	13:10:36, 01 Feb 2015
<input type="checkbox"/>	fpga.rbf	392109 bytes	rw	09:41:15, 23 May 2017
<input type="checkbox"/>	cert01.pem	1371 bytes	rw	09:41:15, 23 May 2017
<input type="checkbox"/>	privrsa.pem	1679 bytes	rw	09:41:15, 23 May 2017
<input type="checkbox"/>	cadc.pem	1472 bytes	rw	09:41:15, 23 May 2017
	templog.c1	131072 bytes	ro	15:18:53, 25 May 2017
<input type="checkbox"/>	privSSH.pem	887 bytes	rw	15:19:30, 25 May 2017
<input type="checkbox"/>	pwds.da0	158 bytes	rw	15:22:19, 25 May 2017
	fwstat.txt	1800 bytes	ro	00:10:06, 31 May 2017
	fwstat.htm	10500 bytes	ro	00:10:06, 31 May 2017
	fwrules.htm	10500 bytes	ro	00:10:06, 31 May 2017
	fwlog.txt	2100 bytes	ro	00:10:06, 31 May 2017
	evstat.txt	10200 bytes	ro	00:10:06, 31 May 2017
	evstat.j			
	privpv.j			
	eventlo			
	statbin.			
	ana.txt			
	anaeth.			
	anappp			
	anaip.c			
	anawifi			
	debug.txt	1000000 bytes	ro	00:10:06, 31 May 2017
	wr44v2-U.mib	1000000 bytes	ro	00:10:06, 31 May 2017

- Open link in new tab
- Open link in new window
- Open link in incognito window
- Save link as...
- Copy link address
- Inspect Ctrl+Shift+I

50 Files, Flash Used: 15795375 Bytes, Flash Free: 113967104 Bytes

Delete selected files

5. Once **debug.txt** is downloaded, send it to Digi Technical Support as file attachment.

Note For Digi TransPort WR44 RR, there are several ways to download the **debug.txt** file. For information on the other methods, see [Quick Note 24 - Extracting the debug.txt file from a TransPort](#).

Cannot open the web interface

If you cannot open the web interface:

1. Make sure the LAN cable is properly connected to the LAN port and that the **LAN** status indicator on the front of the device is illuminated.
2. If it is not, there is a problem with either the LAN cable or the device to which the TransPort device is connected. If the status indicator is illuminated, check that the PC can communicate with the device. To do this, open the Command Prompt window on your PC and enter the command **ping192.168.1.1**. If you do not get a response, you may have a connection problem.
3. Try one or more of the following methods to establish a connection:
 - Use the Digi Device Discovery Utility. The IP address of the device may have been changed from its default IP address of **192.168.1.1**. The Digi Device Discovery Utility can usually discover the device on a network, unless your system's firewall is enabled.
 - Check the PC's IP configuration. Make sure it is set to obtain an IP address automatically. If not, configure it to automatically obtain the IP address.
 - Refresh the PC's IP settings by opening a command window and entering the commands **ipconfig/release** and **ipconfig/renew**
 - Check the PC's LAN connection and any LAN device (such as an Ethernet switch) that connects to the router. Make sure the PC is connected to the network.
 - Clear the PC's ARP cache with the command **arp -d ***, then retry the **ping** command. If you do get a response but are unable to view the web interface, then there is most likely a problem with your web browser configuration.

Cannot log into the web interface

If you cannot log in to the web interface, you will need to access the device via Telnet or SSH in order to configure it using the Command Line Interface (CLI). See [Using the command-line interface](#) for more information.

Troubleshoot the LTE-MIMO antenna orientation

Separate the two LTE antennas at the maximum distance possible, taking into consideration the available space of the installation. There should be a minimum distance of **1.5** inches between two antennas.

Network start verbose call end reasons

The event log for your TransPort WR router may include cellular network start logging messages that provide information about why a call was ended. These messages will look similar to the following:

```
12:16:57, 07 Feb 2019,GPRS: Network start verbose call end reason 209
12:16:57, 07 Feb 2019,GPRS: Network start verbose call end reason type 2
```

The following tables provides details about the call end reason type and the specific reason.

Call end reason type	Component	Description of specific reason
1	Mobile	See Call end reason type 1 .
2	Internal	See Call end reason type 2 .
3	Call manager	See Call end reason type 3 .
6	3rd Generation Partnership Project (3GPP) specification	See Call end reason type 6 .
7	Point-to-Point Protocol (PPP)	See Call end reason type 7 .

Reason number	Reason
Call end reason type 1	
64	The foreign agent rejected Mobile IP (MIP) registration for an unspecified reason.
65	The foreign agent administratively prohibited Mobile IP (MIP) registration.
66	The foreign agent rejected Mobile IP (MIP) registration because of inefficient resources.
67	The foreign agent rejected Mobile IP (MIP) registration because the mobile node authentication (MM-AAA) authenticator was wrong.
68	The foreign agent rejected Mobile IP (MIP) registration because of home agent authentication failure.
69	The foreign agent rejected Mobile IP (MIP) registration because the requested lifetime was too long.
70	The foreign agent rejected Mobile IP (MIP) registration because of a malformed request.
71	The foreign agent rejected Mobile IP (MIP) registration because of a malformed reply.

Reason number	Reason
72	The foreign agent rejected Mobile IP (MIP) registration because the requested encapsulation was unavailable.
73	The foreign agent rejected Mobile IP (MIP) registration because VJ Header Compression was unavailable.
74	The foreign agent rejected Mobile IP (MIP) registration because reverse tunnel was unavailable.
75	The foreign agent rejected Mobile IP (MIP) registration because reverse tunnel is mandatory, but the T bit is not set.
79	The foreign agent rejected Mobile IP (MIP) registration because the delivery style is not supported.
97	The foreign agent rejected Mobile IP (MIP) registration because the Network Access Identifier (NAI) was missing.
98	The foreign agent rejected Mobile IP (MIP) registration because the home agent was missing.
99	The foreign agent rejected Mobile IP (MIP) registration because the home address is missing.
104	The foreign agent rejected Mobile IP (MIP) registration because of an unknown challenge.
105	The foreign agent rejected Mobile IP (MIP) registration because of a missing challenge.
106	The foreign agent rejected Mobile IP (MIP) registration because of a stale challenge.
128	The home agent rejected Mobile IP (MIP) registration for an unspecified reason.
129	The home agent administratively prohibited Mobile IP (MIP) registration.
130	The home agent rejected Mobile IP (MIP) registration because of insufficient resources.
131	The home agent rejected Mobile IP (MIP) registration because of a mobile node (MM-HA) authentication failure.
132	The home agent rejected Mobile IP (MIP) registration because of a foreign agent authentication failure.
133	The home agent rejected Mobile IP (MIP) registration because of a registration ID mismatch.
134	The home agent rejected Mobile IP (MIP) registration because of a malformed request.
136	The home agent rejected Mobile IP (MIP) registration because of an unknown home agent address.
137	The home agent rejected Mobile IP (MIP) registration because reverse tunnel was unavailable.
138	The home agent rejected Mobile IP (MIP) registration because reverse tunnel was mandatory, but the T bit was not set.

Reason number	Reason
139	The home agent rejected Mobile IP (MIP) registration because the requested encapsulation was unavailable.
-1	Unknown reason.
Call end reason type 2	
201	Internal error.
202	The call ended.
203	Unknown internal cause code.
204	Unknown cause code.
205	A close operation was in progress.
206	Network-initiated termination.
207	Another application in modem preempted the data call.
208	IPv4 Packet Data Network (PDN) call was not allowed due to the network providing only IPv6 addresses when the Vendor-Specific Network Control Protocol (VSNCP) was last brought up.
209	IPv4 PDN call was throttled due to previous failure(s) when the VSNCP was last brought up.
210	IPv6 PDN call was not allowed due to the network providing only IPv4 addresses when the VSNCP was last brought up.
211	IPv6 PDN call was throttled due to previous failure(s) when the VSNCP was last brought up.
212	Modem was restarted.
213	Packet Data Protocol (PDP) Point-to-Point Protocol (PPP) calls are not supported.
214	Radio Access Technology (RAT) on which the call was attempted or connected is no longer the preferred RAT.
215	The physical link was in the process of closing.
216	The APN being used has not yet been handed over to the target RAT.
217	The APN bearer type in the profile does not match the preferred network mode.
218	The SIM card was refreshed or removed.
219	The device was going into lower power mode or powering down.
220	The APN has been disabled.
221	The maximum PPP inactivity timer expired.
222	IPv6 address transfer failed.

Reason number	Reason
223	Target Radio Access Technology (RAT) swap failed.
Call end reason type 3	
500	The device is in a Code-Division Multiple Access (CDMA) locked state.
501	An intercept order was received from the base station.
502	A reorder was received from the base station.
503	Received a release from the base station with a Service Option (SO) Reject reason.
504	Received an incoming call from the base station.
505	Received an alert stop from the base station.
506	There was an activation error.
507	The maximum number of access probes were transmitted.
508	Concurrent service is not supported by the base station.
509	No response was received from the base station.
510	The base station rejected the call.
511	The concurrent services requested were not compatible.
512	Already in the traffic channel.
515	Device does not have CDMA service.
516	MC was aborted.
517	Unknown error.
518	User Identity Module (UIM) is not present.
519	Received a retry order from the base station.
520	Access was blocked by the base station.
521	Access is blocked by the base station for all mobile devices.
522	The maximum number of access probes reached for the IS-707B call.
523	Put the device in a thermal emergency.
1000	Configuration failed.
1002	No gateway service.
1003	No General Packet Radio Services (GPRS) context.
1004	Network refused service to the mobile station, because either an identity of the mobile station is not acceptable to the network or the mobile station does not pass the authentication check.

Reason number	Reason
1005	The mobile equipment could not be authenticated and the mobile equipment used is not acceptable to the network.
1006	Operation of either GPRS or non-GPRS services is not allowed.
1007	Operation of GPRS services is not allowed.
1008	No matching identity or context was found in the network.
1009	Mobile reachable timer has expired, or the GPRS Mobility Management (GMM) context data related to the subscription does not exist in the Serving GPRS Support Node (SGSN).
1010	The user equipment requested GPRS service, or the network initiated a detach request, in a Public Land Mobile Network (PLMN) which does not offer roaming for GPRS services to that mobile station.
1011	The mobile station requested service, or the network initiated a detach request, in a location area where the Home Public Land Mobile Network (PLMN) determines that the mobile station, by subscription, is not allowed to operate.
1012	The user equipment requested GPRS service, or the network initiated a detach request, in a PLMN that does not offer roaming for GPRS services.
1013	PDP context already exists.
1014	There was a Radio Access Technology (RAT) change on the user equipment.
1015	The network could not serve a request from the mobile station due to congestion.
1016	The mobile station requested an establishment of the radio access bearers for all active PDP contexts by sending a service request message indicating data to the network, but the SGSN does not have any active PDP context.
1017	Access class blocked restrictions for the current camped cell.
1500	CD is generating or busy.
5001	CD bill or authorization.
5002	Changed HDR.
5003	Exited HDR.
5004	No HDR session.
5005	HDR originated during a GPS fix.
5006	HDR CS timeout.
5007	HDR released by the call manager.
5010	No hybrid HDR service.
2000	Client ended the data call.
2001	Device had no service.

Reason number	Reason
2002	Device lost the system due to fade.
2003	Received a release from the base station with no reason.
2004	Access attempt is already in progress.
2005	Access attempt failed.
2006	The device is in the process of redirecting or handing off to a different target system.
2500	The device is offline.
2501	The device is operating in emergency mode.
2502	The device is in use (for example, a voice call).
2503	The device's operational mode is different from the mode requested in the traffic channel bring up.
2504	The SIM was marked by the network as invalid.
2505	There is no co-located HDR.
2506	Call control was rejected.
Call end reason type 6	
8	The call was not allowed because of Operator Determined Barring (ODB).
25	Logical Link Control (LLC) Sub Network Dependent Convergence Protocol (SNDCCP) failure.
26	Insufficient resources.
27	Unknown APN.
28	Unknown PDP
29	Authentication failure.
30	Activation was rejected by Gateway GPRS Support Node (GGSN), Serving Gateway, or PDN Gateway.
31	Activation was rejected for an unspecified reason.
32	Requested service option is not supported.
33	Requested service option is unsubscribed.
34	Service option temporarily out of order.
35	Network Service Access Point Identifier (NSAPI) is already in used.
36	Regular deactivation.
37	Quality of service (QoS) was not accepted.
38	Network failure.

Reason number	Reason
39	Universal Mobile Telecommunications System (UMTS) reactivation request.
40	Feature not supported.
41	There was a semantic error in the Traffic flow templates (TFT) operation.
42	There was a syntax error in the Traffic flow templates (TFT) operation.
43	Unknown PDP content.
44	There were semantic errors in the packet filter.
45	There were syntax errors in the packet filter.
46	Packet Data Protocol (PDP) was used without an active Traffic Flow Template (TFT).
81	There was an invalid transaction ID.
95	A message was semantically incorrect.
96	There was invalid mandatory information.
97	There was an unsupported message type.
98	There was an incompatible message type.
99	There was an unknown information element.
100	There was a conditional information element error.
101	The message and protocol state was incompatible.
111	There was a protocol error.
112	There was an APN type conflict.
50	Only a PDP of IPv4 is allowed.
51	Only a PDP of IPv6 is allowed
52	Only single address bearers are allowed.
53	Evolved Packet System (EPS) Session Management (ESM) information was not received.
54	The PDN connection does not exist.
55	Multiple connections to the same PDN are not allowed.
Call end reason type 7	
1	A timeout occurred.
2	Authentication failed.
3	An option mismatch occurred.
31	A Push Access Protocol (PAP) failure occurred.
32	A Challenge Handshake Authentication Protocol (CHAP) failure occurred.
-1	Unknown cause.