

2020 | Leak Test Catalog

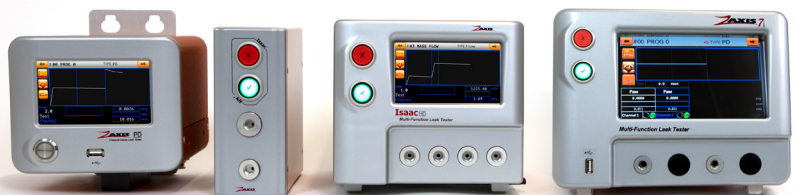

The Natural Selection in Leak Testing Since 1984 |

Configure a Leak Tester	4
Products	8
Options & Accessories	16
Fixtures	21
Engineering	22
Test Types	25
Service	30



The Natural Selection in Leak Testing Since 1984



Located in the heart of Salt Lake City, Utah we have maintained a culture of innovation and success. Still a privately-owned company, we continue to engineer the world's finest leak testing and precision pumping technologies used by household name companies around the world. We are excited about our growth and the amazing people who have helped us along the way. Stay tuned to Zaxisinc.com to be the first to know what new technologies we are developing.

We came from humble beginnings. We were literally working out of a garage. Today, our little garage company has grown into an industry leader. That small company heritage is something we take pride in. We try to act as small as we can when it comes to our customers. We're not interested in the sell-and-forget business. We want to deliver precision products to exceptional customers and build lasting relationships.

Since our humble beginnings, we have come a long way. In the Fall of 2014, we expanded into a 26,000+ SQFT facility to manage our future growth. We are excited to innovate new technologies with the growing Zaxis force and we look forward to meeting you soon. We hope that you find all of your solutions here with us and if not, we hope to provide them for you in the near future.

Configure a Leak Tester

The modular design of Zaxis leak testers enables us to meet the demands of a wide variety of applications.

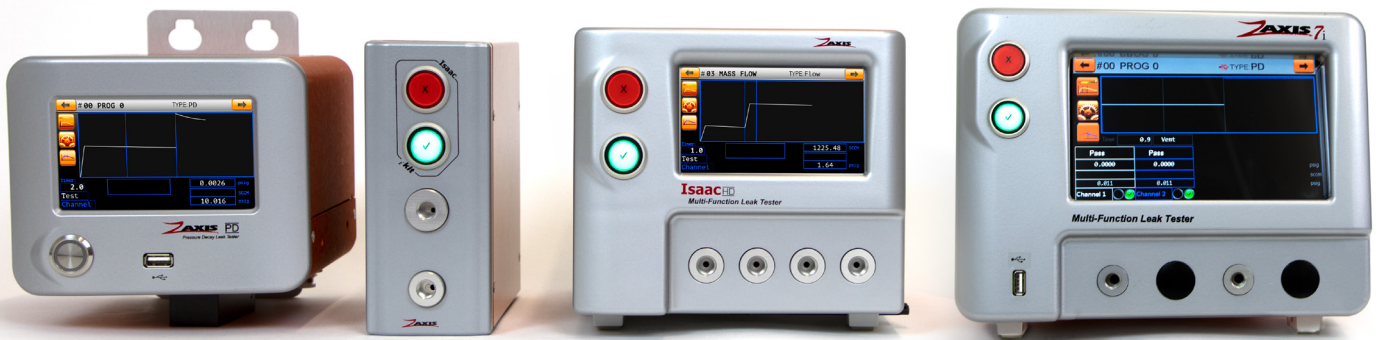

Step 1 - Test Types

The test type is dependent upon your product and its application. For example, only a chamber test can be run on an enclosed object whereas objects with a single opening may use multiple other tests. The most common tests include Pressure Decay (PD), Vacuum Decay (VD), Occlusion (Occ), Mass Flow (F), Burst (B), Pressure Cracking (C), and Chamber (PR). For information on how each test works, see Test Types on page 25.

	Test Types							Ports
	PD	VD	Occ	F	B	C	PR	
Zaxis PD	✓	✓	✗	✗	✗	✗	✗	1
iKit	✓	✓	✓	✓	✗	✗	✓*	1
Isaac HD	✓	✓	✓	✓	✓	✓	✓	4
Zaxis 7i	✓	✓	✓	✓	✓	✓	✓	4

* Limited Volume

Step 2 - Specifications

Zaxis leak testers are configured to your application. Determine your test pressure, test volume, test type, and test time, to help us configure a leak tester for your application.

Step 3 - Options

All testers come with a standard manual pressure regulator or an optional electronic regulator. Concurrent and sequential test sequencers are available in the Isaac HD and 7i. For more on these options please refer to the options section starting on page 16.

Regulators

Standard Manual	Single test pressure, highly stable, ideal for automation
Electronic	Multiple test pressures, extreme versatility

Channels *if applicable

Concurrent	Multiple channels at once
Sequential	One channel at a time in series

Step 4 - Fixture *if applicable

If your product requires a chamber test a fixture is required. For more information on chamber tests see page 28. Occasionally a custom fixture can be suggested for testers built for automation. For more on fixtures please refer to the fixtures section of this catalog on page 21.

Speak to a Sales Representative

For questions about tester configuration please contact us at sales@zaxisinc.com or 801.264.1000.

Configure a Leak Tester



	Zaxis PD	iKit	Isaac HD	Zaxis 7i
Display	4.3"	4.3" Detachable	4.3"	7"
Dimensions	6" W, 7" H, 6.5" D	3" W, 6" H, 6" D	6" W, 7" H, 6" D	10" W, 8" H, 9" D
Max Pressure	100 psi positive/ -14.7 psi vacuum	500 psi positive/ -14.7 psi vacuum	1,000 psi positive/ -14.7 psi vacuum	1,000 psi positive/ -14.7 psi vacuum
Regulator	Built in Electronic	External Manual or built in Electronic	Built in Manual or Electronic	Built in Manual or Electronic
Connectivity	USB, I/O, Ethernet (TCP/IP)	RS232, I/O, Ethernet (TCP/IP or EtherNet/IP)	USB, I/O, RS232, Ethernet (TCP/IP or EtherNet/IP)	USB, I/O, RS232, Ethernet (TCP/IP or EtherNet/IP)
Valves*	Type 1	Types 1-3	Types 1-4	Types 1-4
# of Test Types	1	1	Up to 5	Up to 5
Test Types [§]	PD, VD	PD, VD, Occ, F, PR [†]	PD, VD, Occ, F, B, C, PR	PD, VD, Occ, F, B, C, PR
Multichannel	No	No	Concurrent or Sequential	Concurrent or Sequential
Stored Programs	4	100	100	100
Resolution	0.0001 PSI	0.0001 PSI	0.0001 PSI	0.0001 PSI
Leak Standard	Optional	Optional	Optional	Optional
Fast Fill	Yes	Not Available	Optional	Optional
Power	120/230 VAC, 50/60 Hz 100 Watts	Optional External 24 VDC 60 Watts	120/230 VAC, 50/60 Hz 100 Watts	120/230 VAC, 50/60 Hz 100 Watts

* Valve Selection is based on pressure and flow requirements. Please contact a Zaxis sales representative for more information.

[§] Pressure Decay (PD), Vacuum Decay (VD), Occlusion (Occ), Mass Flow (F), Burst (B), Pressure Cracking (C), and Chamber (PR). See page 25 for more information on the different test types.

[†] Limited Volume.

Leak Tester Configuration Worksheet

Use the information gathered in the three build steps to configure your leak tester.

1. Select Application

Benchtop

Automation

2. Select Test Types *select one or more

Pressure Decay (PD)

Downstream Occlusion (DO)

Crack (C)

Vacuum Decay (VD)

Mass Flow (F)

Chamber (PR)

Occlusion (Occ)

Burst (B)

3. Define Parameters

Pressure Range: _____ psi - _____ psi

Internal Part Volume: _____

Object Dimensions:

Height: _____

Width: _____

Depth: _____

Port Diameter: _____

Desired Test Speed: _____

4. Select Number of Ports

1

2

3

4

5. Select Regulator

Manual

Electronic

6. Select Channels *if applicable

Concurrent

Sequential

7. Communication

PLC I/O

RS232

USB

Ethernet (TCP/IP)

Ethernet (EtherNet/IP)

Zaxis PD

The compact size and mounting orientation of the Zaxis PD enable close proximity to leak test fixtures, thereby reducing connection volume. Reducing test connection volume increases test sensitivity and decreases test times, yielding superior performance. All Zaxis leak testers have a small internal test volume. This optimized small internal test volume combined with integrated sensors and a 24-bit A/D converter enable Zaxis' unparalleled performance. For multi-channel applications, consider purchasing multiple Zaxis PDs or look at the multi-channel Isaac HD.



Benefits:

- Intuitive interface makes test setup quick and easy, no need for a lengthy training session
- Compact size saves valuable manufacturing space
- 4.3" Color Touchscreen
- Lower cost fits more testers into your budget which increases test throughput
- Automatic pressure control allows multiple tests to run at varying pressures without having to adjust the tester
- Wall mountable to free up counter space
- Bottom mounted connectors minimize internal test volume and simplify connectivity
- Onboard processing shows simple statistics without requiring export to a computer
- USB port for easily accessible data collection

	Test Types							Ports
	PD	VD	Occ	F	B	C	PR	
Zaxis PD	✓	✓	✗	✗	✗	✗	✗	1

Zaxis PD Design

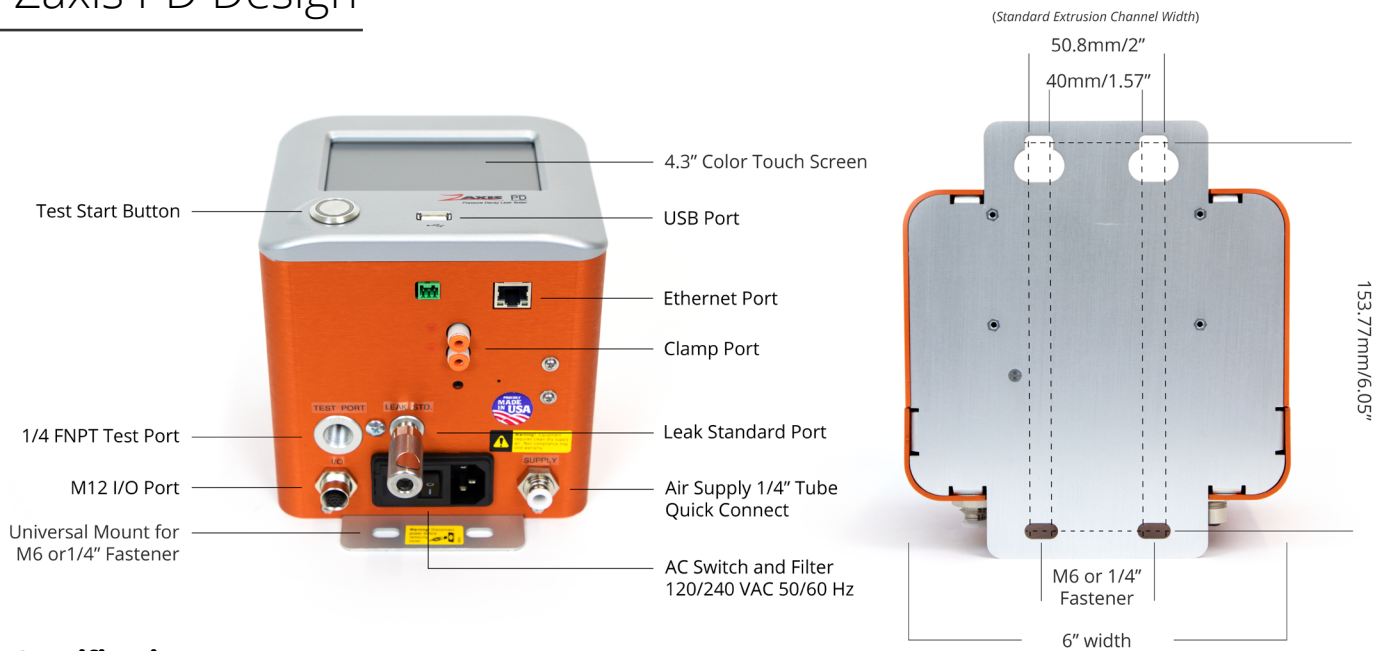

Specifications

Max Pressure	100 PSI of Positive Pressure or -14.7 PSI of Vacuum
Power	120/230 VAC, 50/60 Hz, 100 Watts
Test Port Fitting	1/4 FNPT female bulkhead
Connectivity	USB, RS232, I/O, Ethernet TCP/IP - see page 20
Dimensions	6" wide, 7" high, 6.5" deep
Display	4.3" Color Touchscreen
Regulator	Built in Electronic - see page 18
Leak Standard	Optional tool to test your system - see page 20
Stored Programs	4 - allows you to run multiple parameters through a single port
Time	0.1-999.9 seconds
Resolution	Pressure: 0.0001 PSI

Tester Customization pg. 04

Build a Zaxis PD leak tester to meet your application's specifications.

To learn more about customizing a Zaxis leak tester please contact a sales representative at sales@zaxisinc.com or 801.264.1000.

iKit

The compact size and mounting orientation of the iKit enable it to be utilized in close proximity to test fixtures. By reducing the test connection volume, the test sensitivity increases, and test times can be decreased. Designed to meet today's quality assurance demands the small internal volume combined with integrated sensors and a 24-bit analog to digital converter allow Zaxis to offer a leak tester with the highest sensitivity on the market. The iKit is available for pressure and vacuum decay applications and is configured with one channel. For multiple channel applications multiple iKits can be cascaded for truly synchronous operation.



Benefits:

- Compatible with EtherNet/IP
- Compatible with Zaxis Human-Machine Interface (zHmi) - see page 20
- **Detachable** Intuitive user interface for easy set up and space saving interface removal
- Slim design developed for close connection to the product which increases test sensitivity and decreases the tester's footprint
- Small internal volume (*less than 1 cm³*) increases sensitivity and decreases cycle time
- 24-bit analog to digital converter allows the tester to have ultra-high pressure sensitivity
- Lower cost fits more testers into your budget which increases test throughput
- Onboard processing shows simple statistics without requiring export to a computer

	Test Types							Ports
	PD	VD	Occ	F	B	C	PR	
iKit	✓	✓	✓	✓	✗	✗	✓*	1

* Limited Volume.

iKit Design

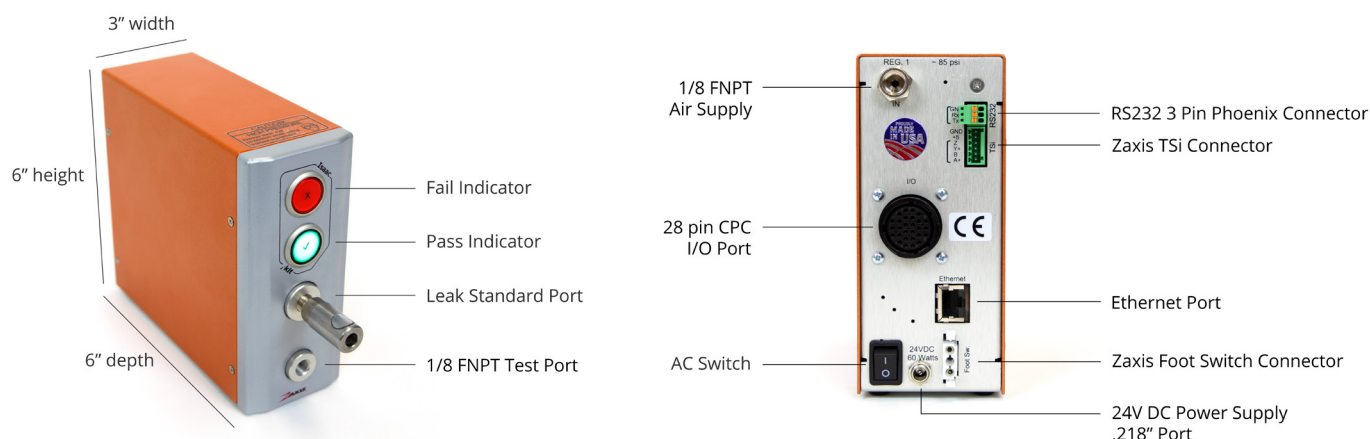

Specifications

Max Pressure	500 PSI of Positive Pressure or -14.7 PSI of Vacuum
Power	24 VDC, 60 Watts
Test Port Fitting	1/8 FNPT female bulkhead
Connectivity	RS232, I/O, Ethernet TCP/IP, EtherNet/IP - see page 20
Dimensions	3" wide, 6" high, 6" deep
Display	4.3" Detachable touchscreen for simple set up and removal
Regulator	External Manual or Electronic, allowing you to use air from your own system or add a regulator to the tester as an option - see page 18
Leak Standard	Optional tool to test your system - see page 20
Stored Programs	100 - allows you to run multiple parameters through a single port
Time	0.1-999.9 seconds
Resolution	Pressure: 0.0001 PSI

Tester Customization pg. 04

Build an iKit leak tester to meet your application's specifications.

To learn more about customizing a Zaxis leak tester please contact a sales representative at sales@zaxisinc.com or 801.264.1000.

Isaac HD

The Isaac HD offers unparalleled test stability and repeatability. It features a large full-color display that makes test setup and execution simple and fast. A small internal volume is often overlooked when purchasing a leak tester, but it is one of the most important specifications. A small internal volume minimizes testing variability such as thermal drift. With a wide range of pressures, you can tailor your leak tester to fit your specific application. Multiple test pressures on the same unit are available. Each tester can be configured for a multitude of different test types, enabling you to minimize your leak testing expenses and maximize your floor space.



Benefits:

- Intuitive interface makes test setup quick and easy, no need for a lengthy training session
- Modular design for custom configurations
- Can run up to 4 test ports and 4 test types at a time
- 4.3" Color Touchscreen
- High Sensitivity thanks to the 24 bit Analog to Digital Converter
- Store up to 100 different test programs for easy transition when testing multiple parts
- Multiple communication options to accommodate any automated system
- Wide pressure range allows for large variation in stored test programs
- Customizable cycle time tailored to your needs
- Small internal test volume, less than 1 cc
- Multiple test types can be configured on the same device

	Test Types							Ports
	PD	VD	Occ	F	B	C	PR	
Isaac HD	✓	✓	✓	✓	✓	✓	✓	Up to 4

Isaac HD Design

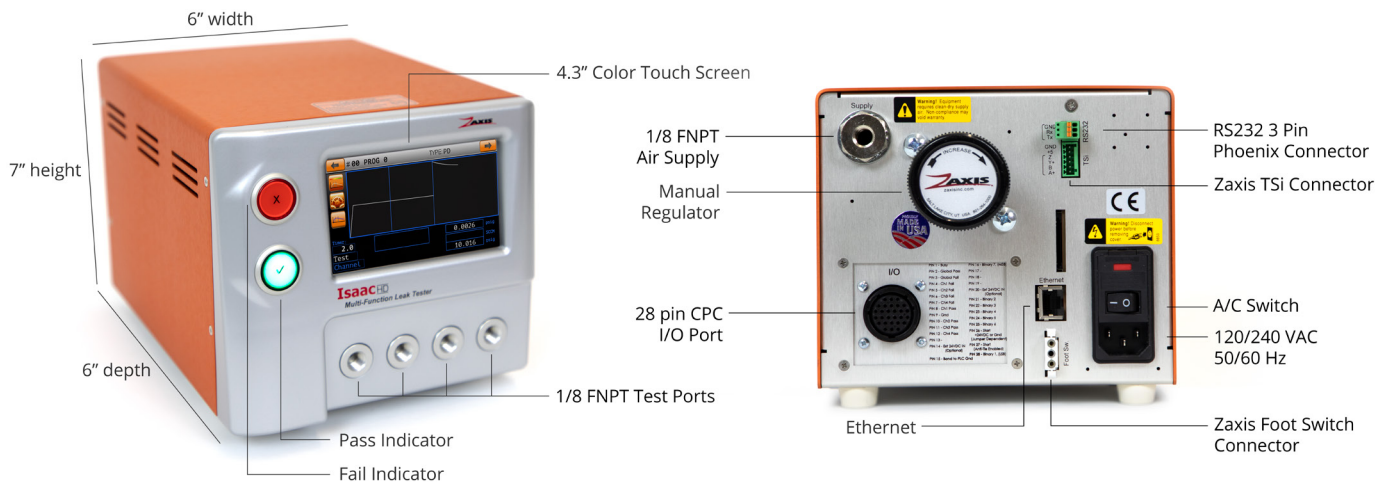

Specifications

Max Pressure	1,000 PSI of Positive Pressure or -14.7 PSI of Vacuum
Power	115/230 VAC, 50/60 Hz auto sensing, 100 Watts
Test Port Fitting	1/8 FNPT female bulkhead
Connectivity	USB, I/O, RS232, Ethernet TCP/IP, EtherNet/IP - see page 20
Dimensions	6" wide, 7" high, 9" deep
Display	4.3" Color Touchscreen
Regulator	Built in manual, built in electronic, or both - see page 18
Leak Standard	Optional tool to test your system - see page 20
Stored Programs	100 - allows you to run multiple parameters through a single port
Time	0.1-999.9 seconds
Resolution	Pressure: 0.0001 PSI

Tester Customization pg. 04

Build an Isaac HD leak tester to meet your application's specifications.

To learn more about customizing a Zaxis leak tester please contact a sales representative at sales@zaxisinc.com or 801.264.1000.

Zaxis 7i

The most sizable leak tester in the Zaxis family is the 7i. Featuring a broad 7 inch touch screen for ease of use, a larger internal capacity, and USB port the Zaxis 7i is the big brother of our leak tester family. Its internal capacity allows for larger valves, resulting in faster test times for applications with larger test volumes.



Benefits:

- Intuitive interface makes test setup quick and easy, no need for a lengthy training session
- Modular design for custom configurations
- Can run up to 4 test ports and 4 test types at a time
- 7" Color Touchscreen
- High Sensitivity thanks to the 24 bit analog to digital converter
- Store up to 100 different test programs for easy transition when testing multiple parts
- Multiple communication options to accommodate any automated system
- Wide pressure range allows for large variation in stored test programs
- Customizable cycle time tailored to your needs
- Multiple test types can be configured on the same device

	Test Types							Ports
	PD	VD	Occ	F	B	C	PR	
Zaxis 7i	✓	✓	✓	✓	✓	✓	✓	Up to 4

Zaxis 7i Design

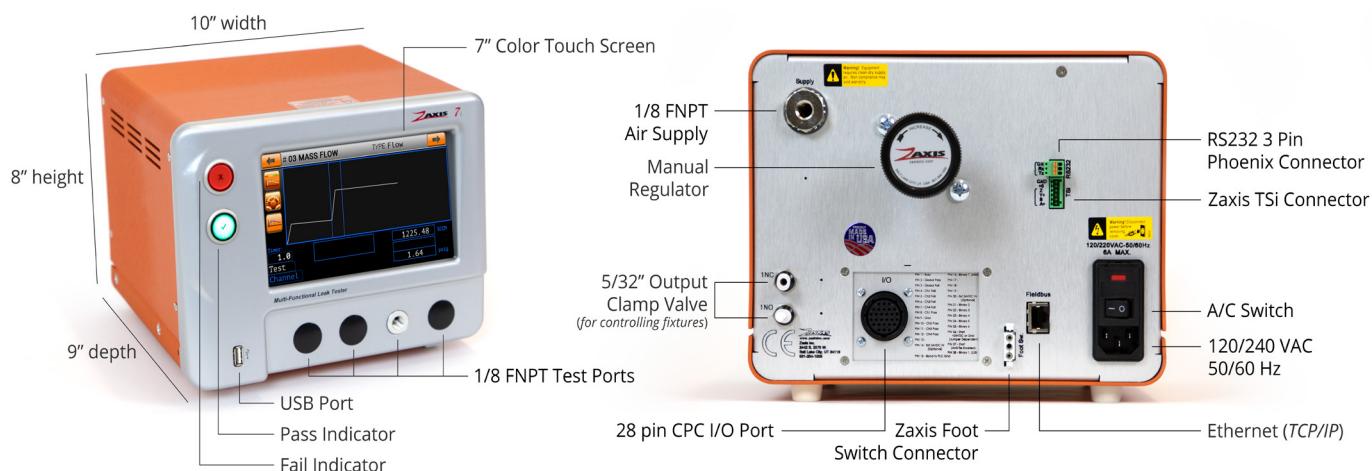

Specifications

Max Pressure	1,000 PSI of Positive Pressure or -14.7 PSI of Vacuum
Power	115/230 VAC, 50/60 Hz auto sensing, 100 Watts
Test Port Fitting	1/8 FNPT female bulkhead
Connectivity	USB, I/O, RS232, Ethernet TCP/IP, EtherNet/IP - see page 20
Dimensions	10" wide, 8" high, 9" deep
Display	7" large touch screen for high readability and ease of use
Regulator	Built in manual, built in electronic, or both - see page 18
Leak Standard	Optional tool to test your system - see page 20
Stored Programes	100 - allows you to run multiple parameters through a single port
Time	0.1-999.9 seconds
Resolution	Pressure: 0.0001 PSI

Tester Customization pg. 04

Build a Zaxis 7i leak tester to meet your application's specifications.

To learn more about customizing a Zaxis leak tester please contact a sales representative at sales@zaxisinc.com or 801.264.1000.

Options & Accessories

The range of applications that can be leak tested is tremendous. These options and accessories can help adapt any Zaxis leak tester to perfectly suit your application.

Channel Sequencers



Concurrent testers run a single test on multiple channel outputs. Each channel has an independent set of test pneumatics and pressure sensors. Pressure and Vacuum Decay can be used on concurrent models.

Sequential testers have a single sensor that is routed to test through one of four channel outputs, testing only one output at a time. The channels that are idle during test are naturally vented to atmosphere, allowing for cross-wall or inter-lumen inspection. All test types except Crack can be ran sequentially.

The iKit and Zaxis PD are single channel type only testers.

Concurrent	Multiple channels at once	Isaac HD, Zaxis 7i
Sequential	One channel at a time	Isaac HD, Zaxis 7i

Concurrent Channel Diagram:

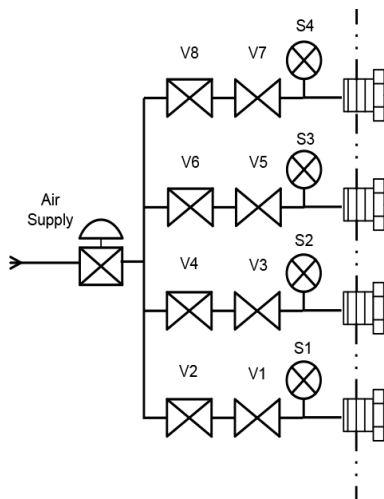

Sequential Channel Diagram:

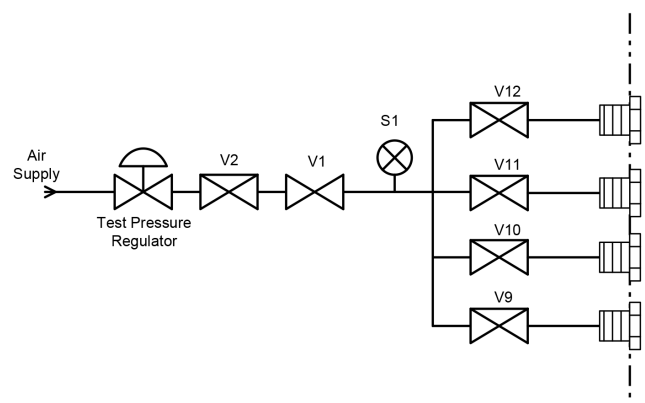

Valves

Zaxis uses the highest quality thermally isolated aseptic valves, excellent for use in clean room applications such as can be found in the medical field. Knowing your test specification such as test pressure, test volume, and desired speed/flow rate will help determine which valves to use for your application.

The graph below illustrates the fill time difference between the Type 1H, Type 1L, Type 1X, and Type 2A valves each filling 92 cc of volume and 229 cc of volume at 10 psi.

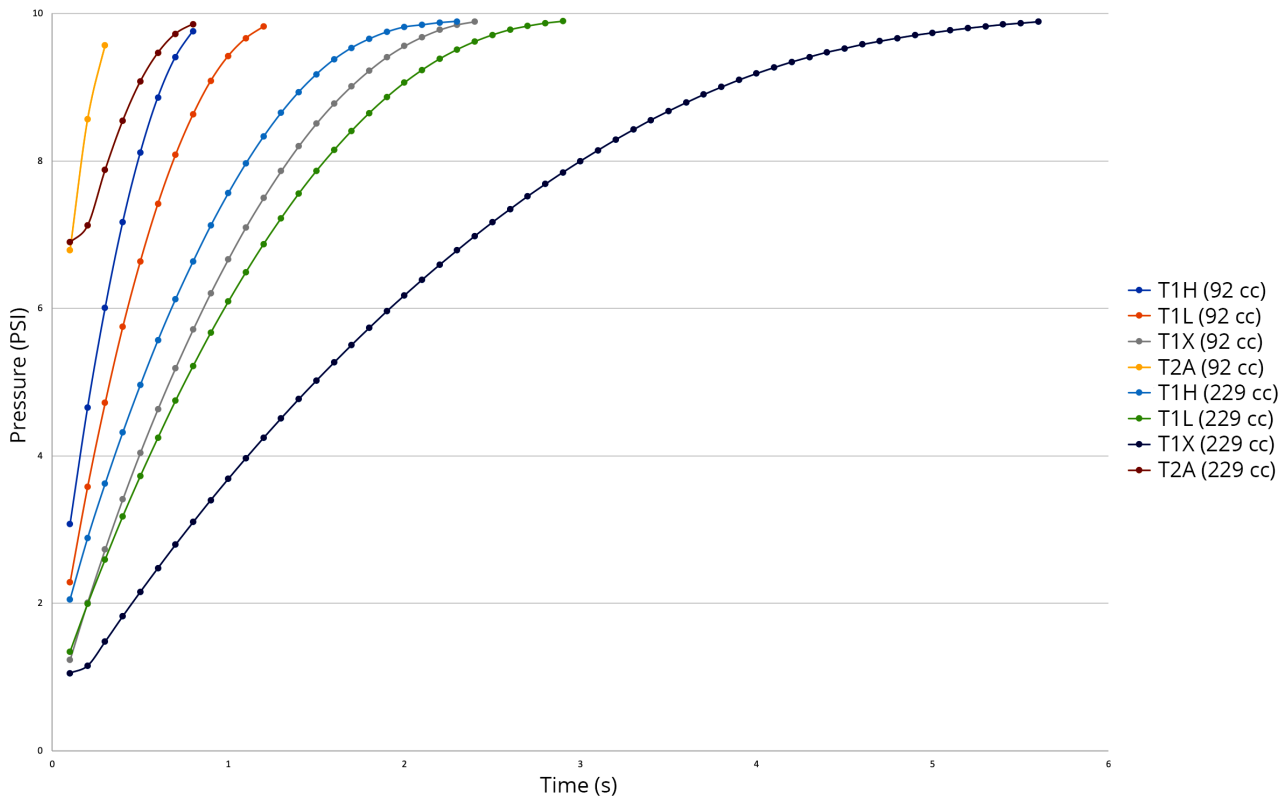

Valve Type	Max PSI	Flow: Liters Per Minute at 10 psi*	Compatible Testers
Type 1H	25 psi	7.4 SLPM	All
Type 1L	50psi	4.6 SLPM	All
Type 1X	107 psi	2.8 SLPM	All
Type 2	300 psi	25 SLPM	iKit, Isaac HD, Zaxis 7i
Type 2 B	130 psi	55 SLPM	iKit, Isaac HD, Zaxis 7i
Type 3	600 psi	4 SLPM	iKit, Isaac HD, Zaxis 7i
Type 4	1000 psi	13.4 SLPM	Isaac HD, Zaxis 7i
High Flow A	30 psi		Isaac HD, Zaxis 7i
High Flow F	60 psi		Isaac HD, Zaxis 7i

* Flow readings determined off a specific test set up, readings may vary.

Regulators



A pressure regulator is a control valve that reduces house air pressure to the designated test pressure. Zaxis testers can use either electronic or manual regulator(s). A combination of regulators may be used for multiple test pressures in a single unit.

Regulator Type	Description	Compatible Testers
Manual	Highly stable single pressure setting	iKit (external), Isaac HD, Zaxis 7i
Second Manual	Allows for two stable pressure settings	Isaac HD, Zaxis 7i
Electronic	Push button calibration with multiple stored settings	Zaxis PD, iKit (external), Isaac HD, Zaxis 7i
Vacuum	Necessary for Vacuum Decay tests	Zaxis PD, iKit (external), Isaac HD, Zaxis 7i
Electronic High Bleed	Helps regulate the difference between high and low pressure settings	All

Fast Fill

Fast Fill is an option for the Isaac HD and Zaxis 7i that allows the product under test to be filled at a quicker rate. Typically, this requires the use of a second port, aside from the test port, with its own pressure regulator.



*Fast Fill of a 30 Gallon Drum

NEMA Box

The Isaac HD multi-tester in a NEMA 13 enclosure offers the same functionality as the Isaac HD or Zaxis 7i leak tester in a larger sealed enclosure. Excellent for use in large industrial areas, the orientation of the NEMA enclosure's fittings can be customized to suit your environment.

Features:

- Tightly sealed enclosure to help reduce dust accumulation in warehouse environments
- Several size options
- Large internal capacity allowing for larger valves
- All the same features and capabilities of the Isaac HD

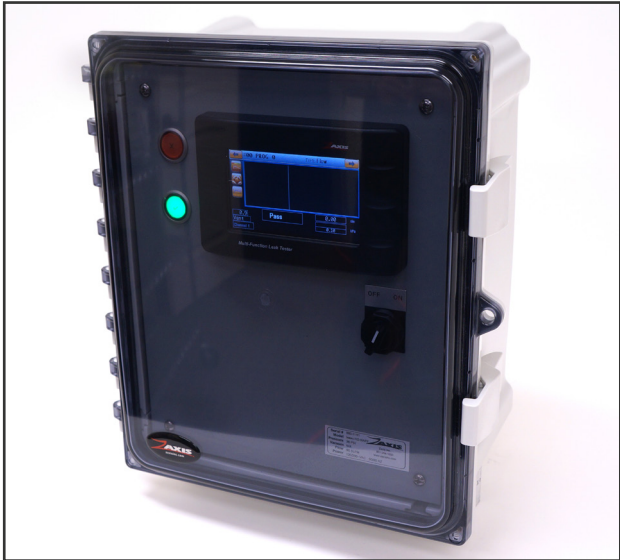

Fittings

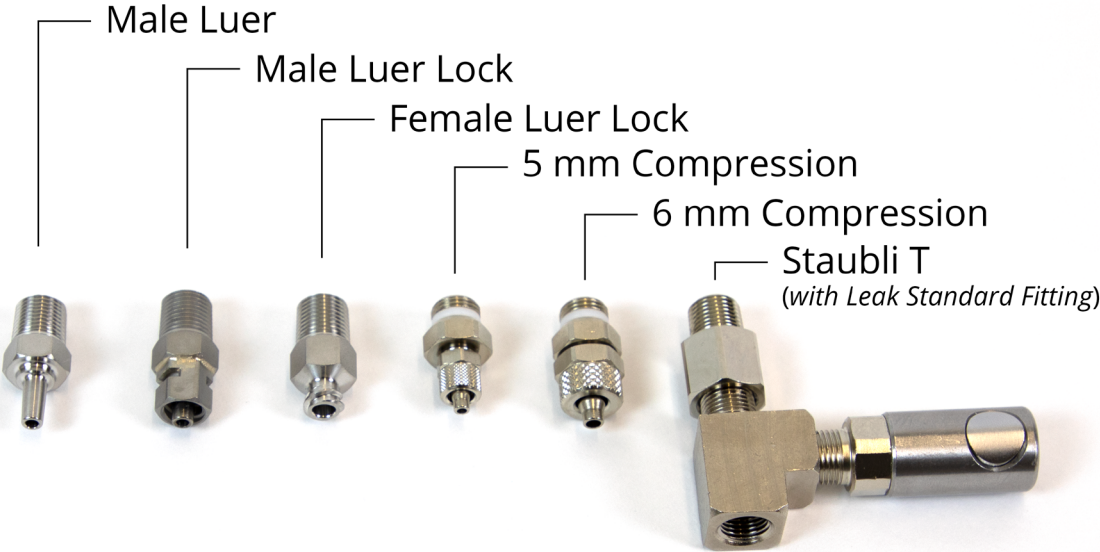

The port on the Zaxis PD is a female 1/4 NPT. The port on the iKit, Issac HD, and Zaxis 7i is a female 1/8 NPT. Any compatible fitting may be used. The most common fittings are the Male Luer, Male Luer Lock, Female Luer Lock, 5 mm compression, 6 mm compression and the Staubli T. Please contact a sales representative with any fitting compatibility questions.

Male Luer	Male Luer taper fitting with slip tip (no threads)
Male Luer Lock	One-piece male Luer taper fitting with threaded sleeve
Female Luer Lock	Threaded female Luer lock fitting that attaches to a tapered male Luer lock fitting
Compression Fitting	Available for 5 mm or 6 mm tubing, other sizes available upon request
Staubli T	Allows for incorporation of a leak standards in circuit

Communication

Flexible communication options allow you to connect your Zaxis leak tester to automation network in the way that works best for you.

The Zaxis testers utilize the latest in industrial network protocols including distributed I/O, USB, Ethernet-TCP/IP or EtherNet/IP™. Legacy connectivity is also available in the form of RS232.

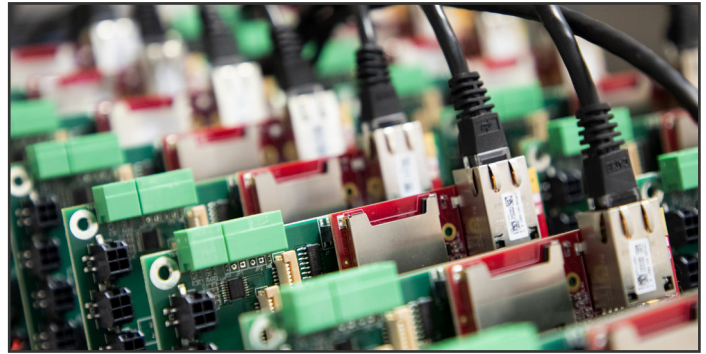

24 VDC I/O	Memory mapped banks with Programmable Logic Controllers
EtherNet/IP™	Real time communication between all devices, not just those connected to controllers
Ethernet TCP/IP	Safe and fast connection with less overhead than a wireless network
RS232	Simple legacy system to system communication with long supported distance
USB	Common and reliable interface with auto-configuration

Quick Connect Pneumatic Sealer



Instant pneumatic connections for smooth or threaded external tubes of various sizes. Optional medical grade materials including FDA approved neoprene seals and clear anodized aluminum construction are available. For questions or quotes on quick connect pneumatic sealers, please speak to a sales representative.

Leak Standard

A leak standard is a calibrated, simulated leak that can be used in circuit with the part under test. A leak standard can be used during test setup to help you determine the parameters for your leak test. It can also be used to challenge your system by comparing multiple leak systems to each other.



Fixtures

When a challenging application cannot be solved by our standard products, we utilize our specialized design, manufacturing, and assembly team. This specialized engineering team may include mechanical engineers, electrical engineers, software engineers, machinists, and assemblers. Zaxis Inc. operates in a 26,000 square foot manufacturing facility optimized for developing custom products for challenging applications. We like being challenged by our customers, because it provides a natural well for innovation.

Clamp Valves

To operate a fixture, a Clamp Valve must be installed on your leak tester. These valves consist of NO (Normally Open) and NC (Normally Closed) air output ports which activate/deactivate the attached fixture. A clamp valve can be seen in the Zaxis 7i design schematic on page 15.

Drawer Fixtures

Specially designed for chamber tests, the Zaxis drawer fixtures come in a variety of sizes to fit your application. Each drawer is built in house and specific to the dimensions of the product being tested. We aim for a snug fit with very little room/volume around your product to achieve the most sensitive test results.

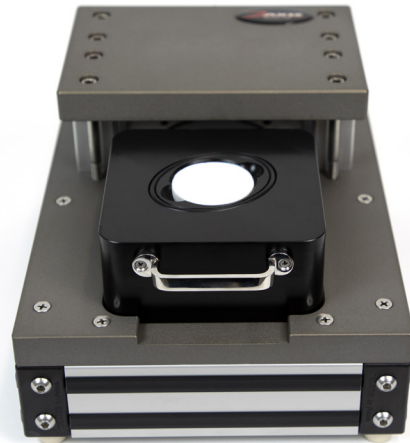

Tombstone

Specially designed to hold the quick connect pneumatic sealers (page 20). These fixtures are made in-house to custom fit a pneumatic sealer of any size, offering safety and stability for your environment.

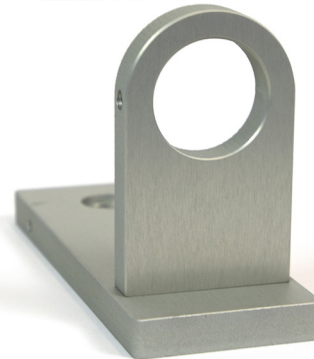

Custom Fixtures

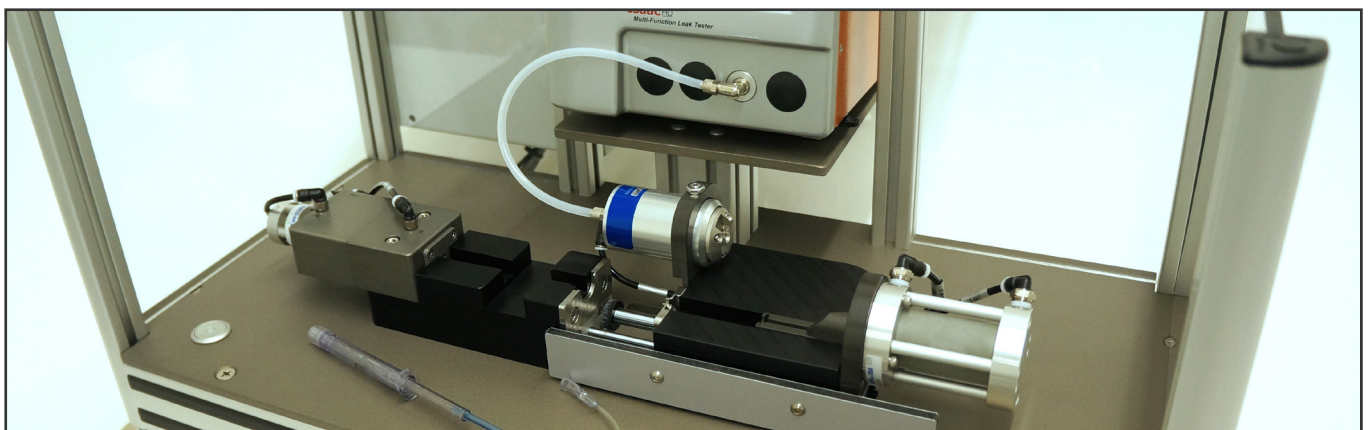

Need to fit a leak test into your automation process? Once you decide which Zaxis tester works best for your application, tell us about your automation process and safety requirements. We will design something perfect for your environment.

Engineering

Zaxis' instruments are built to meet a dynamic manufacturing environment. Quality, speed, and repeatability are at the forefront of the Zaxis design process. The compact size of the Zaxis testers enables them to be utilized in close proximity to test fixtures. By reducing the test cavity volume, the test sensitivity increases, and test times can be decreased. A small internal volume, when combined with integrated sensors and a 24-bit analog to digital converter, allow Zaxis to offer the highest sensitivity on the market.

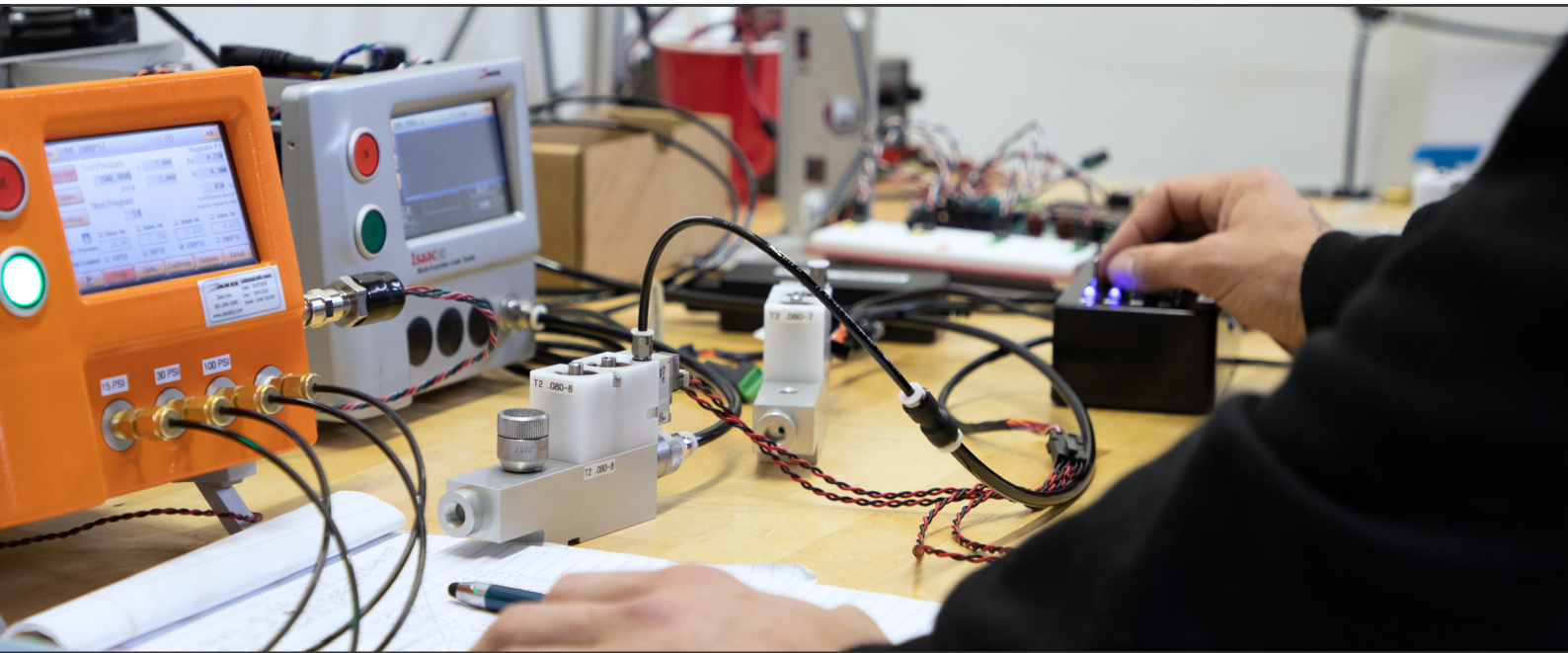

Features:

- < 1 cm³ internal test volume
- Lock up to 3 screens (*setup, calibration, program selection*) for different users
- Intuitive user interface – same interface across all products
- Media compatibility: clean, dry, noncorrosive gasses compatible with anodized aluminum and 316 stainless steel
- Resolution: 0.00001 PSI, Resolution selectable
- Time: 0.1 – 999.9 seconds
- Storage: -20 to 70° C
- 24 VDC PLC I/O, Ethernet (*TCP/IP, EtherNet IP*)
- Onboard stored programs and statistical data
- Engineering units available: PSI, in of H₂O, kPa, mbar, mmHg, cmH₂O
- Graphical touch screen interface, 22.5 mm NEMA 13 lighted push buttons and indicators

Interface







The TSi (Touch Screen Interface) is a built-in or detachable liquid crystal touch screen display, designed for test adaptability and ease of use. Interface options include: Touchscreen Calibration, Clock, I/O Setup, Data Logging, Lock tester, Change PIN, Serial Port, Ethernet Settings.

- Easily programmable parameters (*test times and limits*)
- Two test displays; Large Numeric or Graphic Trend Line
- Six selectable engineering units (*psig, mbar, mmHg, inH₂O, kPa, cmH₂O, inHg*)
- Simple calibration
- Data Logging
- Lock tester parameters, calibration, or current program (*physical barrel key is optional*)
- Included Stylus for ease and accuracy of touch screen interaction

Easy Set-up and Operation

One of the key benefits to the Zaxis family of leak testers is ease of use. Just a few quick steps will get any Zaxis leak tester from out of box to fully operational.



1. The first thing you see when turning on your tester is the About screen which contains important information such as the serial number. After about 5 seconds the About screen will automatically change to the Run screen.
2. On the Run screen select the  Parameters button.
3. On the Parameters Pressure screen  set your test type (*in the top bar*) and your test pressure.
4. Select the Parameters Settings screen  to set your test timers and limits.
5. If applicable, select the Parameters Fixture screen  to set the timer for your fixture clamps.
6. Press the  Play button or the  Green Start button to initiate your test.

zHmi

The Zaxis Human Machine Interface (zHMI) allows you to operate any Zaxis leak tester from any workstation. Through the use of EtherNet/IP communication and operation of leak tests can be done from an office rather than the factory floor. This eliminates the need to leave a desk and gown up just to collect data or change tests.



Valves

Zaxis carries a wide variety of valves to support multiple applications. Most notable are our proprietary Type 2 valves, designed for sensitivity, speed, and thermal stability. Zaxis valves and valve manifolds are aseptic and made with the highest quality materials, perfect for use in testing medical products. The internal test volume held within the test manifold is as small as possible, at less than 1 cubic centimeter. Pilot air actuates the Type 2 valves, which eliminates much of the heat transfer created by standard solenoid/poppet valves. Excess heat transferred into a small sensitive part can adversely affect the test pressure, causing lower test sensitivity and longer test times.

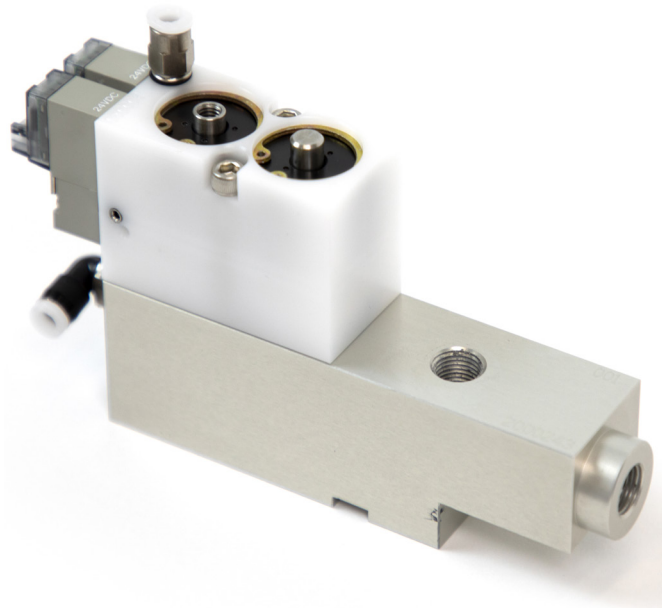

- Air Actuated (*Type 2 valves only*)
- Low Wattage (*less than 1 watt*)
- Aseptic
- Low Internal Volume (*less than 1 cc*)
- High Quality Materials

Calibration

Zaxis offers NIST traceable calibration for all Zaxis Inc. products. To learn more about calibrating your Zaxis leak tester, see the Service section of this catalog on page 31.

To schedule an annual calibration with Zaxis, email us at service@zaxisinc.com or call us at 801.264.1000

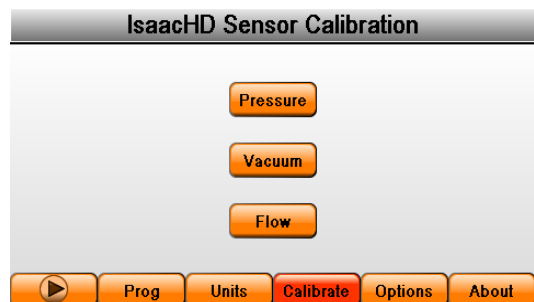

Speak to a Sales Representative

For questions about leak testers or test types please contact us at sales@zaxisinc.com or 801.264.1000.

Test Types

A leak test is used to determine if an object, product, or system functions within a specified leak limit. Leaks occur when gas or liquid flow through an object via an imperfection or manufacturing defect such as holes, cracks, weak seals, etc. Leaks always flow from higher pressure to lower pressure; leak testers use pressure to generate and monitor that flow.

A Leak rate is expressed as a volume per unit time. The rate is found by measuring the change in pressure multiplied by the volume and dividing that by the change in time multiplied by surrounding atmospheric pressure.

atm = Atmospheric pressure (psia)
V = Test volume (cm³)
Δp = The decay in pressure during test time (psi)
Δt = The amount of decay time (min.)
sccm = Standard Cubic Centimeters per Minute

$$\text{Leak rate (sccm)} = \frac{\Delta p * V}{\Delta t * atm}$$

For example:
 Leak rate = .02psi/0.05min * 50cm³/14.7psia
 Leak rate = 0.4 * 3.401
 Leak rate = 1.36 sccm

Note: For proper use of this equation the change in pressure and the atmospheric pressure need to be expressed in the same unit measurements.

Pressure and Vacuum Decay

Pressure decay is one of the most widely used methods of leak testing in manufacturing and is ideal for a sealed component with an access port. In this test, a product is attached to a leak tester and filled with air. Once pressurized, the air supply is shut off and the pressure is allowed to settle. During the test any decrease in air pressure over time signifies a leak. If the part does not leak/decay past its predetermined reject value, it is a good part. The sensitivity of this test is dependent upon the product's size and the time interval of the test. Larger objects require a longer cycle time to reach a high enough sensitivity for a quality test. Smaller objects with small internal volumes will require very low cycle time, allowing a high throughput of production.

Vacuum Decay:

Vacuum Decay tests are the inverse of the same principle, simply creating a negative pressure instead of a positive pressure.

Sample Applications:

- Catheters
- IV Set
- Tubing
- Needleless Injection
- Bag
- Implantable Device
- Infusion Set
- Metering Device
- Sensors/Indicators

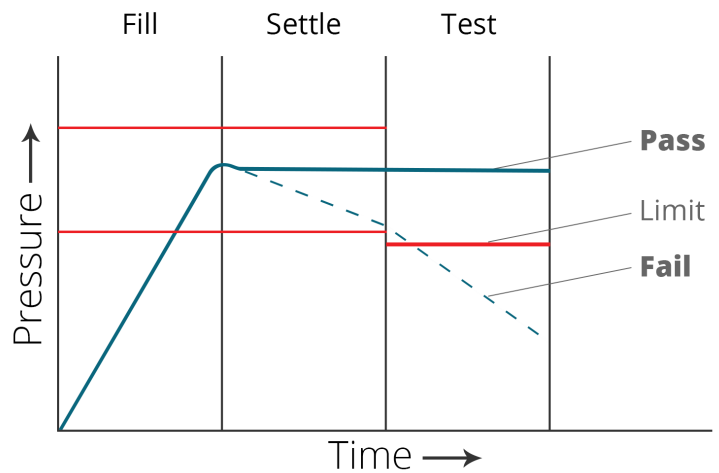

Pressure Decay Diagram:

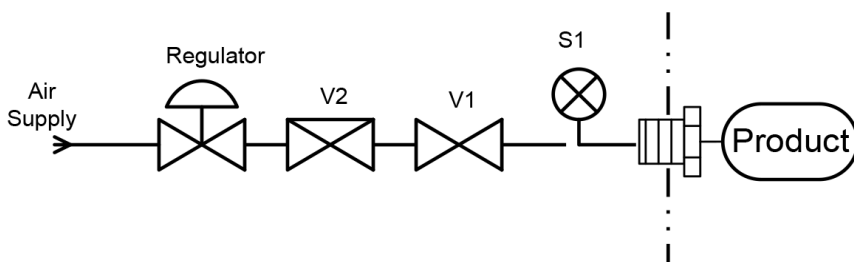

*Vacuum Decay Test



Occlusion

An occlusion test measures the passage of air through an object and signifies if the object's passage is clear or occluded/blocked. This test is an estimated flow using delta pressure. The estimated flow is due to the applied pressure dropping in the test cavity during the test time. To run this test, the product is attached to the test port and filled with regulated air. Once the desired pressure is obtained, all valves are closed off. The air is not allowed to settle, and the test begins immediately after the fill stage. The downstream port is opened to atmosphere during the test and the loss of pressure is measured. If the product exceeds the programed reject value, it is considered a pass. If pressure does not decay past the reject value, it is occluded, and the product does not pass.

Downstream Occlusion:

For proper operation of this test, a downstream release is required. The iKit, Isaac HD, and Zaxis 7i allow for these release valves to be built in, or you can use a clamp (*seal/pinch*) valve with any tester to activate an external release.

Sample Applications:

- Catheters
- Check Valve
- IV Set
- Tubing

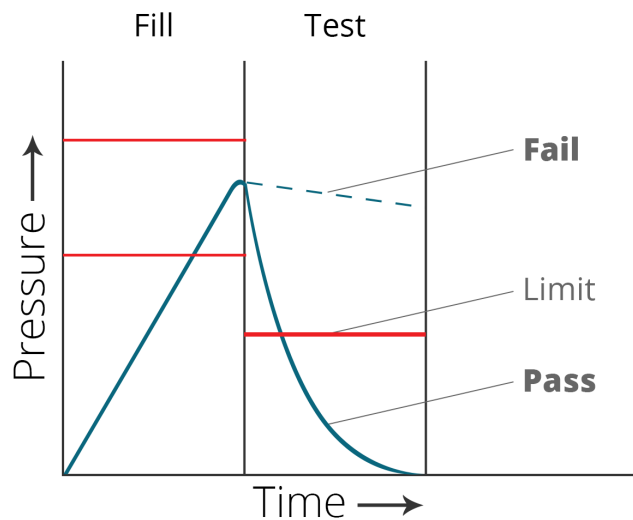

Occlusion Diagram:

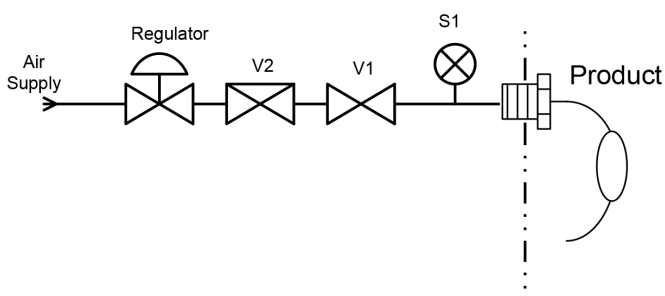

Downstream Occlusion Diagram:

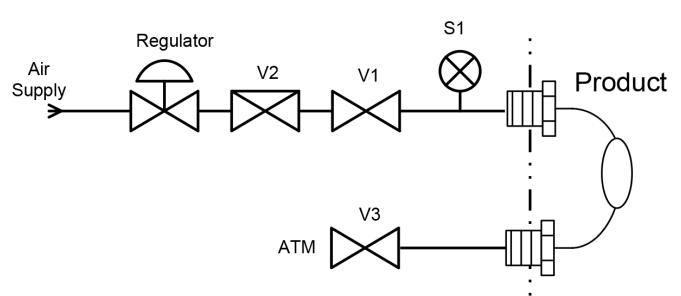

Mass Flow

The Mass Flow test measures flow rate through an object. Once the object is attached to the test port it is pressurized with regulated air. The test pressure is compared to the programmed tolerance using a pressure sensor. During the test, the flow is measured with a Mass Flow Sensor. Objects that have a flow rate that falls between the max flow value and the min flow value pass while those that do not, fail.

Sample Applications:

- Catheter
- IV Set
- Check Valve
- Tubing
- Needleless Injection
- Infusion Set
- Metering Device

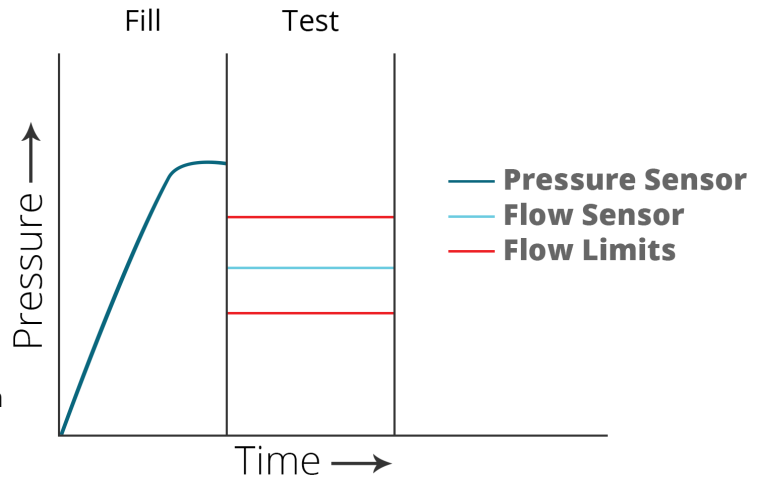

Mass Flow Diagram:

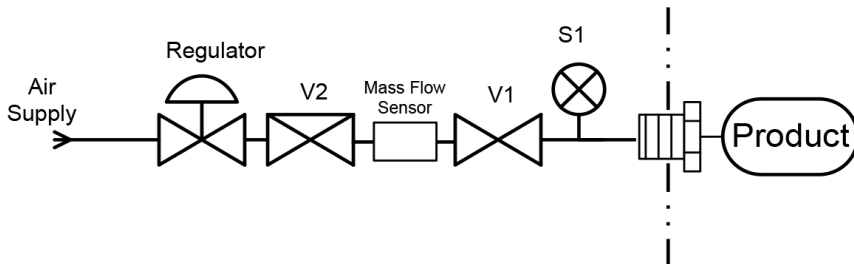

Burst

A Burst test is a destructive pressure test that will measure the maximum pressure at which an object will catastrophically fail or "burst." During this test, an object is attached to a test port and pressurized with regulated air. Pressure sensors measure the pressure ramp rate and burst event, then compare them to predetermined limits for pass or fail. A leak tester with an electronic regulator allows for a programmable ramp rate. This test type is of particular use to design engineers. It can assist with things like material selection and component geometry. A burst test can also be a non-destructive test when run on products such as check valves.

Sample Applications:

- Catheter
- IV Set
- Check Valve
- Tubing
- Bag

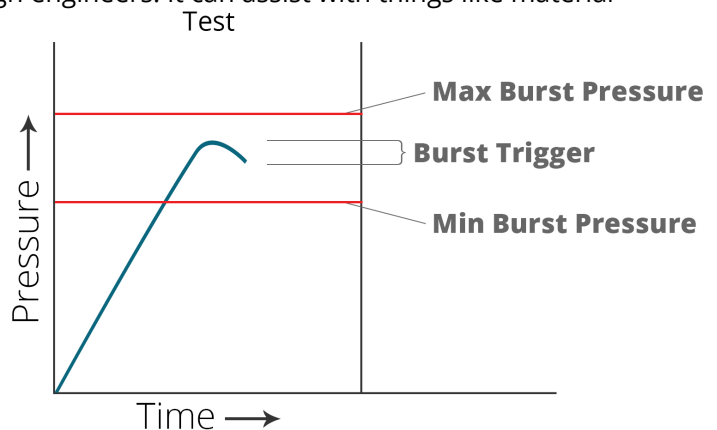

Burst Diagram:

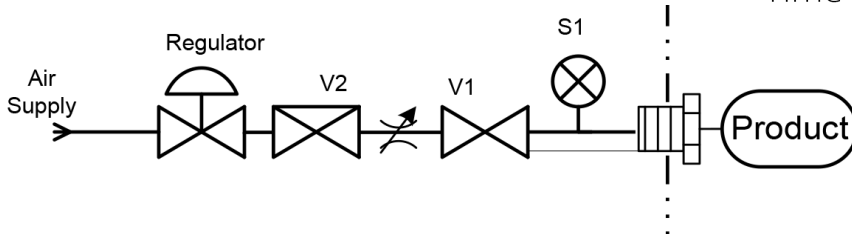

Chamber Test

A chamber test is used to find leaks in sealed packaging or sealed devices that do not include an opening to use for filling. The best technique to test this kind of product is called metered volume fill. In this test, the product will be placed inside a sealed chamber, ideally a chamber close in volume to the product in order to produce the most precise results. The chamber is then pressurized with a measured amount of regulated air. Once the designated pressure has been reached, the test begins. If the pressure holds, the product passes. If the pressure drops then there is a leak in the product, indicating a failed product.

Some applications call for the use of a vacuum chamber test. A vacuum test allows for less sealing pressure due to the automatic sealing of the fixture.

Sample Applications:

- Implantable Device
- Electronic Enclosure
- Sensor/indicator
- Radio
- Cell Phone
- Watch

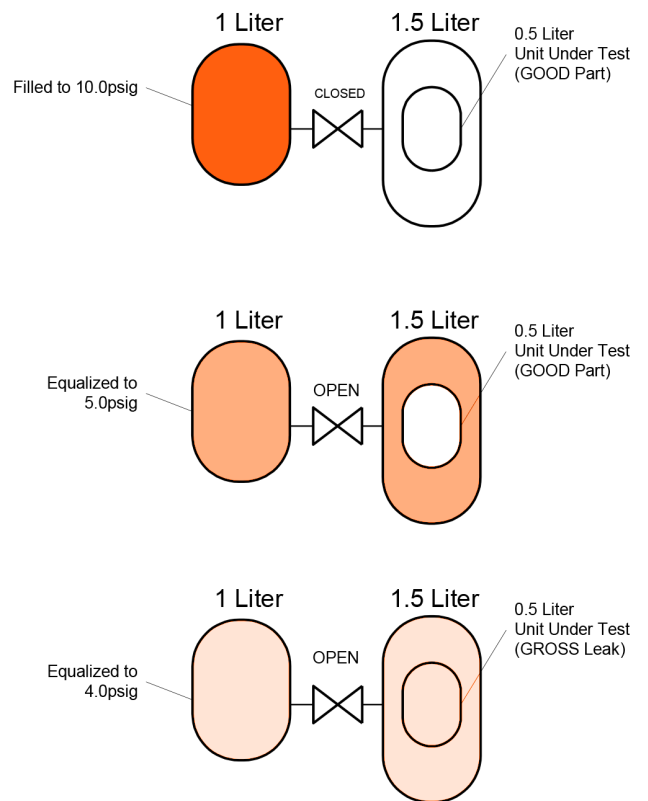

Note: For proper operation, chamber test fixture is required. Please see Drawer Fixtures on page 21 for details.

*Chamber Test with custom drawer fixture

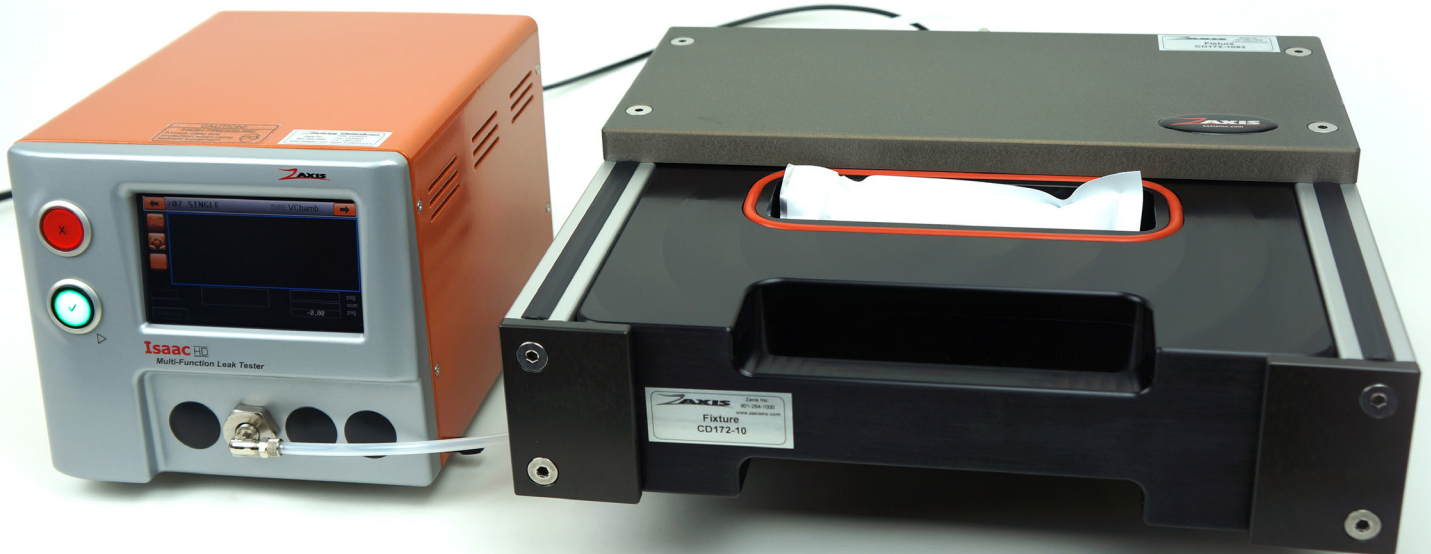

Pressure Cracking

The pressure cracking test is similar to the burst test, in that it detects an event such as a valve opening. The crack test is more sensitive to smaller opening pressures, or parts that weep open. A second pressure sensor is set on the downstream side of the part and monitors for the crack event. The downstream sensor can be a pressure or flow sensor.

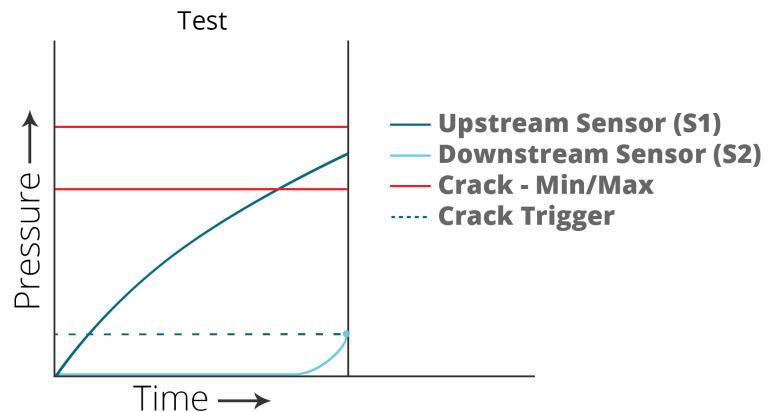

Sample Applications:

- Check Valve
- Needleless Injection Site

Crack Test Diagram:

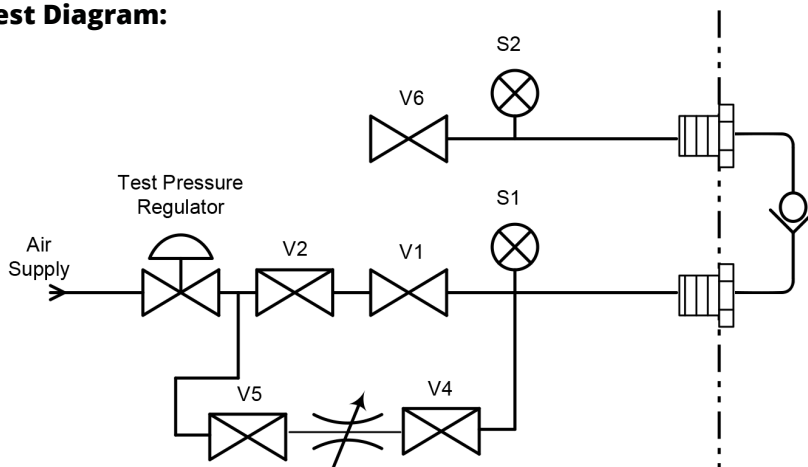

Specialty Tests

In some cases, the standard leak tests are not enough. At Zaxis, we offer several high precision specialty tests to ensure product viability. Using one or more specialty tests, in concert with standard leak tests, can provide the highest level of quality assurance for the development and manufacturing of any product.

Specialty Tests Include:

- Backpressure Flow - While holding the flow rate constant, measure the back pressure created by the part
- Pressure Increase - Pressurize one side of a multichambered part and inspect for an increase on the adjacent side
- Valve Reseat - Measure the amount of pressure at a check valve closure (*used in conjunction with the Crack test that will find the opening pressure*)
- Creep (*Ramping Fill*) - Ramping fill pressure decay test that can be set for multiple stages. Similar to a burst test, with allowances for expansion of the part material
- Pressure Exercise - Exercise a check valve with positive pressure prior to a crack test
- Vacuum Exercise - Exercise a check valve with vacuum pressure prior to a crack test

Service

We stand behind our products and they are built to last. This makes the relationships we build with our customers just as important as the products themselves. With over 35 years of leak testing experience, our service team is ready to troubleshoot and address all of your concerns.



Returns for Repair/Service

All Zaxis leak testers can be returned for repair/service or calibration with written return authorization (case#). Every returned product goes through an extensive evaluation to ensure the tester runs at peak efficiency. To speak to a service specialist or request a return authorization case number, email us at service@zaxisinc.com or call us at 801.264.1000.

Upgrades

Our products are built to last but that doesn't mean our development team sits back on their heels. Innovation is a driving force at Zaxis. Send us your legacy Classic Isaac leak tester and receive a discount and FREE calibration when you upgrade to any new leak tester!

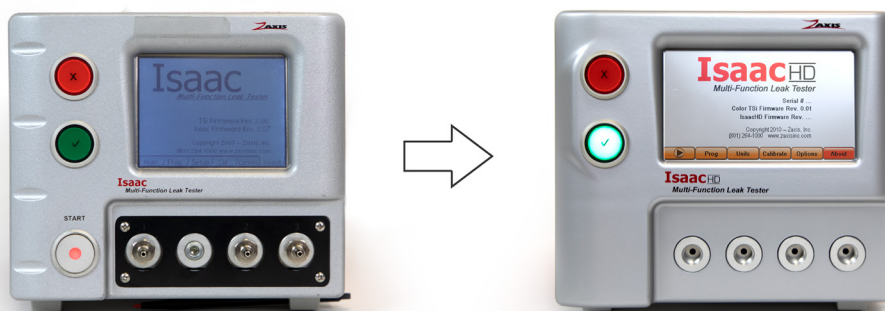

Calibration

Annual sensor calibration is crucial for proper sensor function and accuracy.

In order to precisely calibrate a sensor, you need a pre-calibrated instrument to test against. This instrument must be calibrated according to the National Institute for Standards and Technology (NIST) and achieve an accuracy at least four times higher than that of the sensor you are calibrating.

The sensors in your Zaxis tester should be calibrated annually. If you do not have a calibration instrument to test against you can send your Zaxis tester into our service department for proper calibration. If you are located outside the US, a local calibration house may be a more practical solution.



Speak to a Service Specialist

Email us at service@zaxisinc.com or call us between 8am and 5pm (MST)
Monday through Friday at 801.264.1000.

THREE YEAR LIMITED WARRANTY

Zaxis, Inc. Limited Warranty

ZAXIS INC. products are manufactured to a very high standard, however when located in physically hostile environments or when operated under non-specification voltage or pressure conditions, warranty may be voided. Please refer to your user manual for more detailed information. ZAXIS INC., therefore, warrants only as follows: Supply clean dry air only to the unit.

Each unit is identified by serial number in a permanent record of the company. If at any time with-in three years after any ZAXIS INC. product has been shipped to a customer (user), it fails to perform according to ZAXIS INC. literature, the product, with written explanation of the problem, may be returned, freight prepaid, to ZAXIS INC. for examination, repair or replacement at ZAXIS INC. expense (labor and material). All such returns must have prior ZAXIS INC. customer service authorization before returning. If, upon examination, ZAXIS INC. determines that abusive practices, non-filtered and dried air or destructive environment of operation or a combination of these factors is responsible for improper performance of the product, all labor and materials costs involved shall be at the expense of the customer.

ZAXIS INC. is not liable for special, indirect or consequential damages that may result from use, failure or malfunction of the product and any recovery against ZAXIS INC. may not be greater than the purchase price paid for the product.

No person is authorized to change the terms of this warranty.

Terms and Conditions:

10% prepaid discount included in the quote when Zaxis Terms are met. After credit approval 50% down payment upon receipt of order, balance net 10 days. Down payment must be received prior to shipment of order. Credit Cards accepted; 3% surcharge applies. Zaxis Terms Prevail.

QA Form:

We hereby certify that all materials and processes supplied herein conform to the specifications, drawings approved samples and/or other descriptions.

F.O.B. Zaxis, Inc. Salt Lake City, Utah. Pre pay and add. (Please Specify shipping priority)

The transfer of products to a common carrier constitutes delivery to the buyer and any risk of loss for products shall pass to the buyer at such time.

Delivery:

Standard product (testers and pumps) delivery time is 4-6 weeks (ARO). Non-standard products (fixtures) can range from 8-12 weeks (ARO) but is contingent upon the volume of product purchased. Please check with your sales representative for a shipping timeline. To expedite shipping please place a PO and 50% down deposit as soon as possible.

For full terms and conditions please go to www.zaxisinc.com/terms-conditions.

TESSOL

경기도 용인시 기흥구 흥덕1로 13
흥덕IT밸리 타워동 807호

www.tessol.com
sales@tessol.com
031.713.5988



2442 South 2570 West
Salt Lake City, UT 84119
+1.801.264.1000
zaxisinc.com

