

R4700SD

REED INSTRUMENTS

Data Logging Environmental Meter



Instruction Manual

REED Instruments

1-877-849-2127 | info@reedinstruments.com | www.reedinstruments.com

Table of Contents

Introduction	3
Product Quality.....	4
Safety	4
Features.....	4
Included.....	4
Specifications	5-6
Instrument Description	7
Display Description	8
Operating Instructions.....	9-13
<i>Power ON/OFF</i>	9
<i>Selecting Measurement Modes</i>	9
<i>Air Velocity/Temperature Measurement</i>	9
<i>Humidity/Temperature Mode (rH/tA)</i>	10
<i>Changing the Air Velocity Unit of Measure</i>	10
<i>Type K/J Thermocouple Measurement Mode</i>	10
<i>Light Measurement</i>	11
<i>Changing the Light Meter unit of Measure</i>	11
<i>Zero Adjustment</i>	11
<i>Sound Level Measurement</i> <i>(Requires optional R4700SD-SOUND probe)</i>	12
<i>Data Hold</i>	12
<i>Recording Maximum and Minimum Readings</i>	13
<i>Backlight</i>	13
Setup Mode.....	14-17
<i>Setting the Time and Date (dAtE)</i>	14
<i>Setting Data Decimal Format (dEC)</i>	15
<i>Enabling/Disabling Auto Power Off (PoFF)</i>	15
<i>Enabling/Disabling the Beeper (bEEP)</i>	15

continued...

REED Instruments

1-877-849-2127 | info@reedinstruments.com | www.reedinstruments.com

<i>Selecting Thermocouple Type (tYPE)</i>	16
<i>Setting the Data Logging Sampling Rate (SP-t)</i>	16
<i>Formatting the SD Card (Sd F)</i>	16-17
<i>Verify Set Time and Date</i>	17
<i>Verify Sampling Rate</i>	17
Data Logging.....	17-21
<i>Data Recording Modes</i>	17
<i>Manual Data Logging Mode</i>	17-18
<i>Automatic Data Logging Mode</i>	18
<i>Transferring Data from the SD Memory Card to a Computer</i>	19-21
Data Stream Output.....	22
<i>3.5mm Terminal to RS-232 Serial Connection</i>	22
System Reset.....	23
Battery Replacement.....	23
Applications.....	23
Accessories and Replacement Parts.....	23-24
Frequently Asked Questions (FAQ's).....	24
Product Care.....	25
Product Warranty.....	25
Product Disposal and Recycling.....	26
Product Support.....	26

Introduction

Thank you for purchasing your REED R4700SD Data Logging Environmental Meter. Please read the following instructions carefully before using your instrument. By following the steps outlined in this manual your meter will provide years of reliable service.

Product Quality

This product has been manufactured in an ISO9001 facility and has been calibrated during the manufacturing process to meet the stated product specifications. If a certificate of calibration is required please contact the nearest authorized REED distributor or authorized Service Center. Please note an additional fee for this service will apply.

Safety

Never attempt to repair or modify your instrument. Dismantling your product, other than for the purpose of replacing batteries, may cause damage that will not be covered under the manufacturer's warranty. Servicing should only be provided by an authorized service center.

Features

- Measures air velocity/temperature, ambient temperature, relative humidity, light, and contact temperature
- Measures sound level (dB) with R4700SD-SOUND (sold separately)
- Air velocity is measured in m/s, ft/min, km/h, mph or knots
- Light levels are measured in foot-candles or lux
- Temperature is measured in °C or °F
- Data hold and Max/Min functions
- Real-time datalogger with integrated SD memory card
- User selectable sampling rate from 1 to 3600 seconds
- Easy-to-read backlit LCD display
- Tripod mount for long-term monitoring
- Low battery indicator and auto shut off

Included

- Multi-Function Probe
- Hard Carrying Case
- Batteries

Specifications

Air Velocity

Measuring Ranges:

m/s: 0.4 to 30.0
km/h: 1.4 to 108
mph: 0.9 to 67.1
fpm: 79 to 5906
knots: 0.8 to 58.3

Accuracy:

$\pm 2\% + 0.2$ m/s
(0.8 km/h; 0.4 mph; 40 fpm; 0.4 knot)

Resolution:

0.1 m/s, km/h, mph, knot
1 fpm

Temperature

Measuring Ranges

Air Temperature: 32 to 122.0°F
(0 to 50°C)

Contact Temperature:

Type K Temperature: -148 to 2372°F
(-100 to 1300°C)

Type J Temperature: -148 to 2192°F
(-100 to 1200°C)

Accuracy:

Air Temperature: $\pm 0.8^\circ\text{C}$ ($\pm 1.5^\circ\text{F}$)
Contact Temperature: $\geq -58^\circ\text{F}$ (-50°C)
 $\pm(0.4\% + 1.5^\circ\text{F}$ (0.8°C))
 $\leq -58^\circ\text{F}$ (-50°C) $\pm(0.4\% + 1.8^\circ\text{F}$ (1°C))
0.1°F/°C

Resolution:

Humidity

Measuring Range:

5 to 95% RH

Accuracy:

$>70\%RH$: $\pm(3\% \text{ rdg} + 1\%RH)$
 $<70\%RH$: $\pm 3\%RH$

Resolution:

0.1% RH

Light

Measuring Ranges:

0 to 20,000 Lux (0 to 1,860 Ft-cd)

Accuracy:

$\pm(5\% \text{ rdg} \pm 8 \text{ dgt})$

Resolution:

1 Lux/0.1 Ft-cd

Sound (Optional, R4700SD-SOUND Adapter Sold Separately)

Measuring Ranges:

30 to 80dB
50 to 100dB
80 to 130dB

continued...

REED Instruments

1-877-849-2127 | info@reedinstruments.com | www.reedinstruments.com

Accuracy:	Basic Accuracy of ± 3.5 dB
Resolution:	1 dB
General Specifications	
Response Time:	1 second
Display:	4-digit dual LCD
Backlit Display:	Yes
Data Hold:	Yes
Min:	Yes
Max:	Yes
Zero Adjustment:	Yes (for Light)
Datalogging Capabilities:	Yes
Real-Time Clock and Date Stamp:	Yes
Selectable Sampling Rate:	Yes (1, 2, 5, 10, 30, 60, 120, 300, 600, 1800, 3600 seconds)
External Memory:	Yes, expandable up to 16GB with SD card (optional)
Auto Shut-off:	Yes (after 10 minutes/off)
Kick Stand:	Yes
Tripod Mountable:	Yes
Low Battery Indicator:	Yes
Power Supply:	6 x AA batteries or AC Adapter (optional)
Data Output:	Yes (RS-232)
Product Certifications:	CE
Operating Temperature:	0 to 122°F (0 to 50°C)
Storage Temperature:	14 to 140°F (-10 to 60°C)
Operating Humidity Range:	10 to 85%
Dimensions:	Instrument: 5.3 x 2.4 x 1.3" (135 x 60 x 33mm) Probe: 4.1 x 1.8 x 1.1" (105 x 46 x 29mm)
Weight:	1.1lb (515g)

Instrument Description

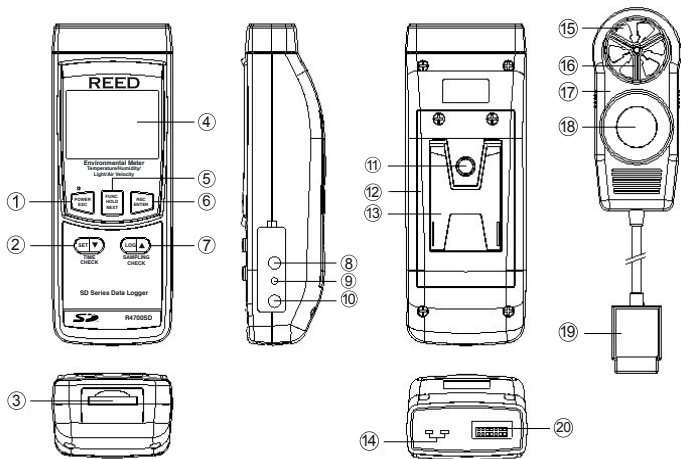

1. POWER/Backlight/ESC Button
2. SET/Down/TIME CHECK Button
3. SD Card Slot
4. LCD Display
5. HOLD/FUNCTION/NEXT Button
6. REC/ENTER Button
7. LOG/Up/SAMPLING CHECK Button
8. RS-232 Output Jack
9. Reset Pin
10. Power Adapter Input
11. Tripod Mounting Screw
12. Battery Cover
13. Kickstand
14. Type K/J Thermocouple Input Jack
15. Anemometer Vane
16. Humidity/Temperature Sensor
17. Environmental Probe Head
18. Light Sensor
19. Environmental Probe Plug
20. Probe Input Socket

REED Instruments

1-877-849-2127 | info@reedinstruments.com | www.reedinstruments.com

Display Description

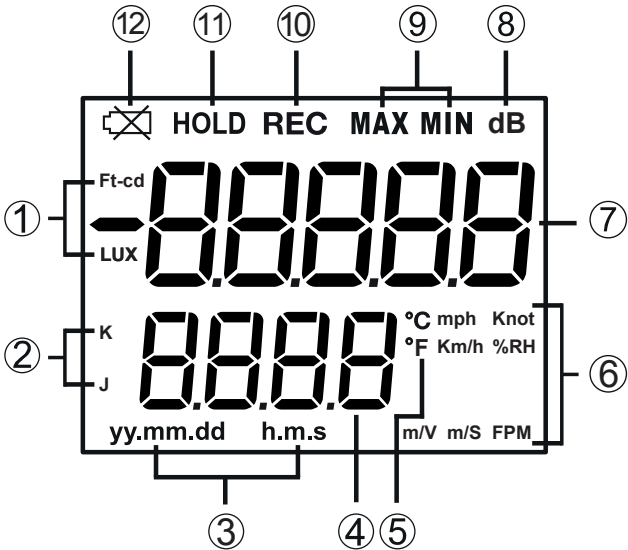

- | | |
|---|-----------------------------------|
| 1. Light Unit of Measure | 7. Measurement Reading Indicator |
| 2. Thermocouple Type Indicator | 8. Sound Unit of Measure |
| 3. Date/Time Stamp | 9. Maximum and Minimum Indicators |
| 4. Date & Time Values/
Temperature Measurement Reading | 10. Record Mode Indicator |
| 5. Temperature Unit of Measure | 11. Data Hold Indicator |
| 6. Units of Measure | 12. Low Battery Indicator |

Operating Instructions

Power ON/OFF

Turn the meter on by pressing the **POWER** button. To turn the meter off, press and hold the **POWER** button for 2 seconds.

Note: This meter can be powered by either six (6) "AA" batteries or AC adapter (sold separately).

Selecting Measurement Modes

The R4700SD offers 4 types of measurement modes:

- Air Velocity/Temperature
 - Humidity/Temperature
 - Type K/J Thermocouple Temperature
 - Light Meter
1. When the meter is on, press and hold the **FUNCTION** button to scroll through the measuring modes. The display will flash "An" (for air velocity/temperature measurements), "rH" (for humidity/temperature measurements), "tP" (for type K/J thermocouple temperature measurements), "LIgHT" (for light measurements).
 2. Release the **FUNCTION** button to confirm selection.

Air Velocity/Temperature Measurement

1. Plug the environmental probe into the probe input socket while the meter is off.
2. Once the meter is powered up, select "An" function (see *Selecting Measurement Modes* for details).
3. Hold the probe handle and face the anemometer head towards the direction of the airflow. The top part of the display will indicate the air velocity, and the lower part of the display will indicate the air temperature value as shown above.

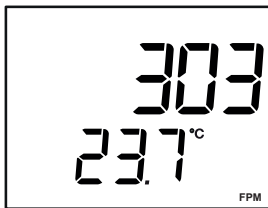

continued...

REED Instruments

1-877-849-2127 | info@reedinstruments.com | www.reedinstruments.com

Humidity/Temperature Mode (rH/tA)

1. Plug the environmental probe into the probe input socket while the meter is off.
2. Select the "rH" function (see *Selecting Measurement Modes* for details).
3. The top part of the display will indicate the humidity value while the lower part of the display will indicate the air temperature value as shown.

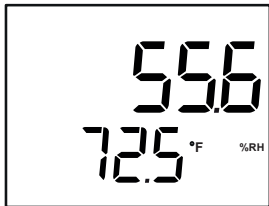

Changing the Air Velocity Unit of Measure

To change the air velocity unit of measure, press and hold the UNIT button. The display will scroll through each unit (m/S, Km/h, mph, Knot, & FPM). Release the UNIT button to select the displayed unit. The selected unit will be saved as the new default unit of measure.

Type K/J Thermocouple Measurement Mode

1. Select the "tP" function (see *Selecting Measurement Modes* for details).
2. Plug the optional Type K or J Thermocouple Probe into the Type K/J thermocouple input jack.

Note: Make sure to remove the environmental probe before inserting the thermocouple probe.

3. The screen will display a "K", confirming that it is configured by default to a Type K thermocouple probe. The measured temperature will now be displayed on the LCD screen.

Note: If using a type J thermocouple probe, see *Selecting Thermocouple Type* for details.



continued...

Light Measurement

1. Plug the environmental probe into the probe input socket while the meter is off.
2. Select the "LlGht" measurement mode (see *Selecting Measurement Modes* for details).
3. Hold the probe handle and face the probe head against the measuring light source.
4. The display will show the light measurement value as shown below.

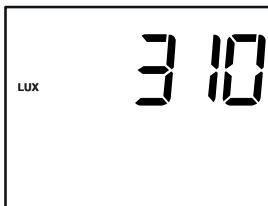

Changing the Light Meter unit of Measure

1. Press and hold the UNIT button, while in the Light Meter measurement mode.
2. The LCD display will toggle between the units LUX and Ft-cd.
3. Release the UNIT button to select the displayed unit.
4. The selected unit will be saved as the new default.

Zero Adjustment

1. While taking a light measurement, completely cover the light sensor.
2. If the LCD display does not show value of zero, hold the **LOG** button until the LCD display shows a zero value.

Sound Level Measurement (Requires optional R4700SD-SOUND probe)

1. Plug the optional sound probe into the Probe Input Socket while the meter is off.
2. When the meter is powered on, the LCD display will indicate "Sound" confirming it is now in sound measurement mode.
3. There are three manual dB ranges to select from:
Range 1: 30 - 80 dB range
Range 2: 50 - 100 dB range
Range 3: 80 - 130 dB range
4. When the appropriate dB range is selected, hold the probe comfortably in one hand (away from your body). Point the microphone in the direction of the noise to take a measurement.

Note: Direct contact with strong winds or blowing air on the microphone may cause measurement errors. These effects can be reduced by using the optional windscreen (REED-WB).

5. The display will show the sound measurement value as shown below.

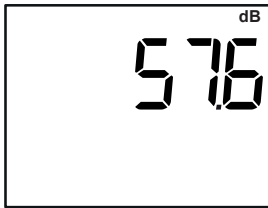

Data Hold

1. While taking a measurement, press the **HOLD** button to freeze the current readings on the display.
2. While in this mode a HOLD symbol will appear.
3. Press the **HOLD** button again to resume normal operation.

Note: When the Data Hold feature is active all buttons except the **POWER** button are disabled.

continued...

REED Instruments

1-877-849-2127 | info@reedinstruments.com | www.reedinstruments.com

Recording Maximum and Minimum Readings

1. Press the **REC** button to enter recording mode as indicated by "REC" on the LCD. The meter will now begin recording maximum and minimum readings.
2. While in recording mode;
 - A) Press the **REC** button once and the maximum value will appear on the display as indicated by "REC MAX".
 - B) Press the **REC** button again and the minimum value will appear on the display as indicated by "REC MIN".
 - C) To exit recording mode and resume normal operation, press and hold the **REC** button for two seconds.

When in recording mode the **POWER** button is disabled and the meter cannot be turned off.

Backlight

After powering the meter ON, the LCD Backlight will turn on automatically. Press the BACKLIGHT button to turn the LCD Backlight on or off.

Setup Mode

1. Press and hold the **SET** button for 2 seconds to enter Setup Mode.
2. Press the **NEXT** button continuously to scroll through the following parameters.

Parameter	Description
dAtE	Set the time and date
dEC	Set the decimal format (USA (20.00) or European (20,00))
PoFF	Enable or disable the auto-power off function
bEEP	Turn the beeper on or off
tYPE	Select thermocouple type (K or J)
t-CF	Select the temperature unit of measure (°C or °F)
SP-t	Set the data logging sampling rate
Sd F	Format the SD memory card

3. Once the appropriate parameter has been selected, follow the instructions below.

Note: The meter automatically exits out of the Setup mode if no key is pressed within 7 seconds.

Setting the Time and Date (dAtE)

1. Press the **ENTER** button when "dAtE" appears on the LCD.
2. Press the **▲** and **▼** buttons to adjust the year as indicated by "YY."
3. Press the **ENTER** button to confirm selection.
4. Repeat steps 1 and 2 for month, day, hour, minute and seconds as indicated by (mm/dd/h/m/s).
5. After each value has been selected and confirmed, it will automatically skip to the next parameter.

Note: At any time, you can press the **ESC** button to exit the Setup mode and resume normal operation. The internal clock will keep accurate time when the meter is powered off. When new batteries are installed the clock will have to be reset.

continued...

Setting Data Decimal Format (dEC)

Numeric formats vary in different countries. By default the meter is set to bASIC mode where a decimal point is used to separate units, (i.e. 20.00). The European format uses a comma (i.e. 20,00) to separate units. To change this setting, follow steps 1 and 2 when the "dEC" parameter appears on the LCD.

1. Press the ▲ and ▼ buttons to select between bASIC and Euro.
2. Press the **ENTER** button to confirm selection and skip to next parameter.

Note: At any time, you can press the **ESC** button to exit the Setup mode and resume normal operation.

Enabling/Disabling Auto Power Off (PoFF)

Follow steps 1 and 2 when "PoFF" appears on the LCD.

1. Press the ▲ and ▼ buttons to select between ON (enabled) or OFF (disabled). With the Auto Power OFF feature enabled, the meter will automatically switch OFF after 10 minutes of inactivity to preserve battery life.
2. Press the **ENTER** button to confirm selection and skip to next parameter.

Note: At any time, you can press the **ESC** button to exit the Setup mode and resume normal operation.

Enabling/Disabling the Beeper (bEEP)

Follow steps 1 and 2 when "bEEP" appears on the LCD.

1. Press the ▲ and ▼ buttons to select between ON (enabled) or OFF (disabled).
2. Press the **ENTER** button to confirm selection and skip to next parameter.

Note: At any time, you can press the **ESC** button to exit the Setup mode and resume normal operation.

continued...

Selecting Thermocouple Type (tYPE)

Follow steps 1 and 2 when "tYPE" appears on the LCD.

1. Press the ▲ and ▼ buttons to select between type K and J.
2. Press the **ENTER** button to confirm selection and skip to next parameter.

Note: At any time, you can press the **ESC** button to exit the Setup mode and resume normal operation.

Selecting the Temperature Unit of Measure (t-CF)

Follow steps 1 and 2 when "t-CF" appears on the LCD.

1. Press the ▲ and ▼ buttons to select between °C and °F.
2. Press the **ENTER** button to confirm selection and skip to next parameter.

Note: At any time, you can press the **ESC** button to exit the Setup mode and resume normal operation.

Setting the Data Logging Sampling Rate (SP-t)

Follow steps 1 and 2 when "SP-t" appears on the LCD.

1. Press the ▲ and ▼ buttons to adjust the sampling rate between 0, 1, 2, 5, 10, 30, 60, 120, 300, 600, 1800, and 3600 seconds.
2. Press the **ENTER** button to confirm selection and skip to next parameter.

Note: At any time, you can press the **ESC** button to exit the Setup mode and resume normal operation.

Formatting the SD Card (Sd F)

Follow steps 1 through 5 when "Sd F" appears on the LCD.

1. Press the ▲ and ▼ buttons to select "YES" to format the card. Select "NO" to abort.
2. Press the **ENTER** button to confirm selection.
3. Press the **ENTER** button again to re-confirm.
4. The meter will format the SD card and automatically return to the Setup menu when formatting is complete.
5. Press the **ESC** button to exit the Setup mode and resume normal operation.

continued...

Note: It is recommended that new SD cards should be formatted prior to first use. If the formatting process fails, the meter will display -E-.

Verify Set Time and Date

During normal operation press the TIME CHECK button to display the year, month, day, hour and minutes.

Verify Sampling Rate

During normal operation, press the SAMPLING CHECK button to view the selected sampling rate.

Data Logging

Data Recording Modes

Manual Data Logging: Press the **LOG** button to manually log up to 99 readings on a SD memory card (see *Manual Data Logging Mode* section for full setup instructions).

Automatic Data Logging: Setup the meter parameters in order to automatically log data on a SD memory card. The number of data points is limited by the size of the memory card.

Note: It is recommended to use a class 4 SDHC memory card between 1Gb and 16Gb. Insert the SD memory card in the slot at the bottom of the meter. The card must be inserted with the label side facing the rear of the meter.

Manual Data Logging Mode

In manual mode, the **LOG** button is pressed to manually log a reading on the inserted SD card at any time. In order to setup the meter for manual data logging, follow steps 1 through 8 below.

1. Set the data logging sampling rate to "0" seconds (see Setting the Data Logging Sampling Rate section for details).
2. Press the **REC** button and "REC" will appear on the LCD.
3. The meter will also display P-X (X = memory position number between 1 and 99).
4. Press the **SET** button to enter the data memory positions selection.
5. Press the **▲** and **▼** buttons to select one of the 99 data memory positions in which to record.

continued...

6. Press the **ENTER** button to confirm selection.
7. Press the **LOG** button to save a reading to memory. "SCAn Card" will flash each time a data point is stored.

Note: If a card is not inserted or the card is defective, the meter will flash "CArD -E-". In this case, power the meter OFF and try again with another SD memory card or verify that the card is correctly inserted.

8. To exit manual data logging mode, press and hold the **REC** button 2 seconds to resume normal operation.

Automatic Data Logging Mode

In automatic mode the desired data logging sampling rate is set to 1, 2, 5, 10, 30, 60, 120, 300, 600, 1800 or 3600 seconds prior to recording (see *Setting the Data Logging Sampling Rate* section for details). In order to setup the meter for automatic data logging, follow steps 1 through 5 below.

1. To begin a data logging session, press the **REC** button and "REC" will appear on the LCD.
2. Press the **LOG** button. The meter will scan for a SD memory card.

Note: If a card is not inserted or the card is defective, the meter will flash "CArD -E-" indefinitely. In this case, power the meter OFF and try again with another SD memory card or verify that the card is correctly inserted.

3. The "REC" icon will appear on the LCD and will continuously flash while in a data logging session.
4. To pause the data logging session press the **LOG** button and "REC" will stop flashing. To resume press the **LOG** button again.
5. To end the current data logging session pause the data logging session and hold the **REC** button until "REC" disappears.

continued...

Transferring Data from the SD Memory Card to a Computer

1. While the meter is powered Off remove the SD memory card from the SD card slot.
2. Insert the SD memory card into the computer.
3. Open the file(s) with Excel. See sample below for a Light measurement:

Place	Date	Time	Value	Unit
1	19-07-10	12:18:28	275	LUX
2	19-07-10	12:18:30	341	LUX
3	19-07-10	12:18:32	293	LUX
4	19-07-10	12:18:34	417	LUX
5	19-07-10	12:18:36	398	LUX
6	19-07-10	12:18:38	358	LUX
7	19-07-10	12:18:40	361	LUX

The raw data can be used to create a graph in Excel. See sample below:

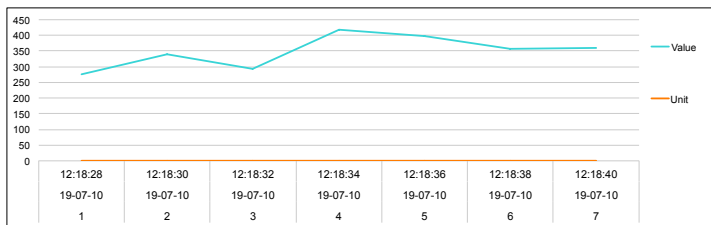

continued...

See sample below for a Humidity/Temperature measurement:

Place	Date	Time	Value	Unit	Value	Unit
1	19-07-10	12:19:00	15.4	%RH	22.8	RHTemp C
2	19-07-10	12:19:02	15.4	%RH	22.7	RHTemp C
3	19-07-10	12:19:04	20	%RH	22.7	RHTemp C
4	19-07-10	12:19:06	45	%RH	30	RHTemp C
5	19-07-10	12:19:08	14.6	%RH	22.7	RHTemp C
6	19-07-10	12:19:10	14.5	%RH	22.7	RHTemp C
7	19-07-10	12:19:12	35	%RH	35	RHTemp C
8	19-07-10	12:19:14	14.3	%RH	22.7	RHTemp C
9	19-07-10	12:19:16	14.3	%RH	22.7	RHTemp C
10	19-07-10	12:19:18	60	%RH	35	RHTemp C
11	19-07-10	12:19:20	14.2	%RH	22.7	RHTemp C
12	19-07-10	12:19:22	14.1	%RH	22.7	RHTemp C
13	19-07-10	12:19:24	45	%RH	30	RHTemp C
14	19-07-10	12:19:26	14	%RH	22.7	RHTemp C
15	19-07-10	12:19:28	13.9	%RH	22.7	RHTemp C
16	19-07-10	12:19:30	55	%RH	35	RHTemp C
17	19-07-10	12:19:32	13.9	%RH	22.7	RHTemp C
18	19-07-10	12:19:34	13.9	%RH	22.7	RHTemp C
19	19-07-10	12:19:36	13.9	%RH	22.7	RHTemp C

The raw data can be used to create a graph in Excel. See sample below:

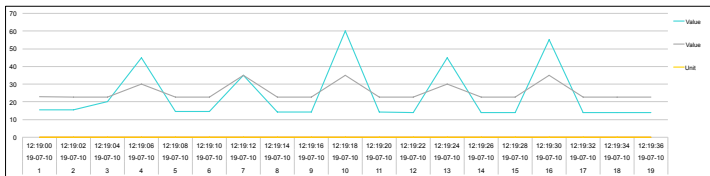

continued...

REED Instruments

1-877-849-2127 | info@reedinstruments.com | www.reedinstruments.com

See sample below for a Air Velocity/Temperature measurement:

Place	Date	Time	Value	Unit	Value	Unit
1	19-07-10	12:39:51	0	m/S	22.4	AMTemp C
2	19-07-10	12:39:53	0	m/S	22.4	AMTemp C
3	19-07-10	12:39:55	2.2	m/S	22.4	AMTemp C
4	19-07-10	12:39:57	2.4	m/S	22.4	AMTemp C
5	19-07-10	12:39:59	10	m/S	25	AMTemp C
6	19-07-10	12:40:01	5.6	m/S	22.5	AMTemp C
7	19-07-10	12:40:03	2.4	m/S	22.6	AMTemp C
8	19-07-10	12:40:05	1.1	m/S	22.6	AMTemp C
9	19-07-10	12:40:07	15	m/S	30	AMTemp C
10	19-07-10	12:40:09	2	m/S	22.7	AMTemp C
11	19-07-10	12:40:11	1.1	m/S	22.7	AMTemp C
12	19-07-10	12:40:13	0	m/S	22.7	AMTemp C
13	19-07-10	12:40:15	10	m/S	25	AMTemp C
14	19-07-10	12:40:17	0	m/S	22.6	AMTemp C
15	19-07-10	12:40:19	0	m/S	22.6	AMTemp C
16	19-07-10	12:40:21	0.9	m/S	22.6	AMTemp C
17	19-07-10	12:40:23	10	m/S	30	AMTemp C
18	19-07-10	12:40:25	3.4	m/S	22.6	AMTemp C
19	19-07-10	12:40:27	1.8	m/S	22.7	AMTemp C
20	19-07-10	12:40:29	0.9	m/S	22.7	AMTemp C

The raw data can be used to create a graph in Excel. See sample below:

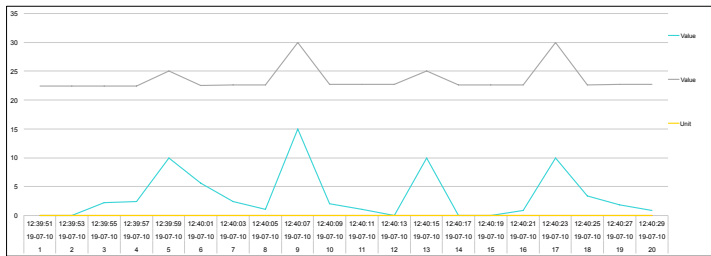

Data Stream Output

Using Terminal application, a data stream can be viewed from the RS-232 output, connect RS-232/USB cable between the product and terminal/PC and use the following setting to view the data stream.

Terminal Settings:

- Bits per second: 9600
- Data bits: 8
- Parity: None
- Stop bits: 1

41110000000335 = Upper Value, 335 FPM

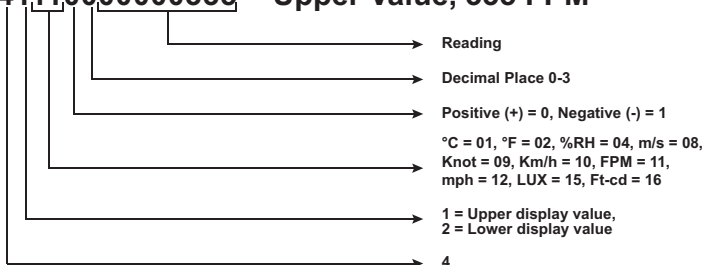

3.5mm Terminal to RS-232 Serial Connection

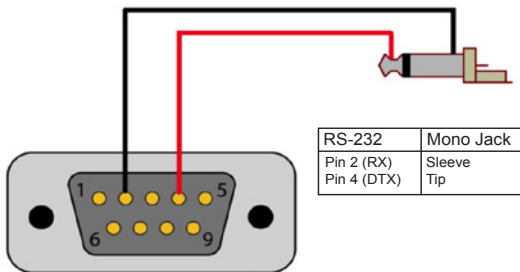

REED Instruments

1-877-849-2127 | info@reedinstruments.com | www.reedinstruments.com

System Reset

If the meter becomes unresponsive or if the display freezes, the Reset pin button can be used to reset the instrument.

1. Use a paper clip or any similar small object to press the Reset pin.
2. After pressing the Reset pin, power the meter back up by holding the **POWER** button for 2 seconds.
3. If resetting the meter does not resolve the issue, please return the meter to the nearest authorized REED distributor or authorized Service Center for repair.

Battery Replacement

When the low battery icon  appears on the LCD, the batteries must be replaced.

1. Remove the two (2) Phillips screws on the back of the meter directly located above the top of the kickstand.
2. Remove the battery cover.
3. Replace 6 x "AA" batteries.
4. Secure the battery cover with the two (2) Phillips screws.

Applications

- Meteorological Stations
- Environmental Monitoring

Accessories and Replacement Parts

R4700SD-PROBE Replacement Probe for R4700SD

R4700SD-SOUND Sound Level Adaptor

R2920 Surface Thermocouple Probe

R2930 Right Angle Thermocouple Probe

R2940 Air/Gas Thermocouple Probe

R2950 Immersion Thermocouple Probe

R2960 Needle Tip Thermocouple Probe

continued...

REED Instruments

1-877-849-2127 | info@reedinstruments.com | www.reedinstruments.com

TP-01 Beaded Thermocouple

R1500 Tripod

RSD-ADP-NA Power Supply, 110V

RSD-ADP-EU Power Supply, 220V

CA-05A Soft Carrying Case

R8888 Deluxe Hard Carrying Case

SD-4GB 4GB Class 4 SDHC Memory Card

RSD-16GB 16GB Micro SD Memory Card w/ Adapter

Don't see your part listed here? For a complete list of all accessories and replacement parts visit your product page on www.reedinstruments.com.

Frequently Asked Questions (FAQ's)

I cannot turn off my meter, do you know why?

Often times, the meter cannot be turned off because it is in recording mode ("REC" mode). Make sure to exit that function by holding down the **REC** button before attempting to turn the meter off.

How long can I record for?

Battery life will depend on a number of factors:

- Quality of Battery
- Whether the beeper is ON or OFF
- Whether the backlight is ON or OFF
- Environmental Conditions during data logging

As a reference, using alkaline batteries with both the backlight and beeper on while automatic data logging at a 2 second sampling rate; the batteries lasted approx. 14 hours.

Product Care

To keep your instrument in good working order we recommend the following:

- Store your product in a clean, dry place.
- Change the battery as needed.
- If your instrument isn't being used for a period of one month or longer please remove the battery.
- Clean your product and accessories with biodegradable cleaner. Do not spray the cleaner directly on the instrument. Use on external parts only.

Product Warranty

REED Instruments guarantees this instrument to be free of defects in material or workmanship for a period of one (1) year from date of shipment. During the warranty period, REED Instruments will repair or replace, at no charge, products or parts of a product that proves to be defective because of improper material or workmanship, under normal use and maintenance. REED Instruments total liability is limited to repair or replacement of the product. REED Instruments shall not be liable for damages to goods, property, or persons due to improper use or through attempts to utilize the instrument under conditions which exceed the designed capabilities. In order to begin the warranty service process, please contact us by email at 1-877-849-2127 or info@reedinstruments.com to discuss the claim and determine the appropriate steps to process the warranty.

Product Disposal and Recycling



Please follow local laws and regulations when disposing or recycling your instrument. Your product contains electronic components and must be disposed of separately from standard waste products.

Product Support

If you have any questions on your product, please contact your authorized REED distributor or REED Instruments Customer Service by phone at 1-877-849-2127 or by email at info@reedinstruments.com.

Please visit www.REEDINSTRUMENTS.com for the most up-to-date manuals, datasheets, product guides and software.

Product specifications subject to change without notice.

All rights reserved. Any unauthorized copying or reproduction of this manual is strictly prohibited without prior written permission from REED Instruments.

REED

INSTRUMENTS

TEST & MEASURE WITH CONFIDENCE



CHECK OUT OUR LATEST PRODUCTS!

REED Instruments

1-877-849-2127 | info@reedinstruments.com | www.reedinstruments.com

REED INSTRUMENTS

TEMPERATURE
& HUMIDITY



SOUND



MOISTURE



AIR VELOCITY



ELECTRICAL



REED Instruments

1-877-849-2127 | info@reedinstruments.com | www.reedinstruments.com