

Note

This manual applies to version 1.01f and higher.

PPCH

Hydraulic Pressure Controller/Calibrator

Operation and Maintenance Manual



High pressure liquids and gases are potentially hazardous. Energy stored in these liquids and gases can be released unexpectedly and with extreme force. High pressure systems should be assembled and operated only by personnel who have been instructed in proper safety practices.



This instrument is not to be operated in any other manner than that specified by the manufacturer.

TABLE OF CONTENTS

TABLE OF CONTENTS	I
TABLES	V
FIGURES	VI
ABOUT THIS MANUAL	VII
1. INTRODUCTION	1
1.1 PRODUCT OVERVIEW	1
1.2 SPECIFICATIONS	2
1.2.1 GENERAL SPECIFICATIONS	2
1.2.2 PRESSURE MEASUREMENT SPECIFICATIONS.....	3
1.2.2.1 QUARTZ REFERENCE PRESSURE TRANSDUCER (Q-RPT)	3
1.2.2.2 UTILITY SENSOR.....	4
1.2.2.3 ON-BOARD BAROMETER	4
1.2.3 PRESSURE CONTROL SPECIFICATIONS	4
2. INSTALLATION	5
2.1 UNPACKING AND INSPECTION	5
2.1.1 REMOVING FROM PACKAGING.....	5
2.1.2 INSPECTING CONTENTS.....	5
2.2 SITE REQUIREMENTS.....	6
2.2.1 INSTALLATION IN A 19 IN. RACK MOUNT	6
2.3 INITIAL SETUP	7
2.3.1 PREPARING FOR OPERATION	7
2.3.2 FRONT AND REAR PANELS	7
2.3.2.1 FRONT PANEL	7
2.3.2.2 REAR PANEL.....	8
2.3.3 POWER CONNECTION.....	8
2.3.4 REMOTE [ENTER/SET P] CONNECTION (FOOTSWITCH OR OTHER SWITCH)	8
2.3.5 CONNECTING PNEUMATIC POWER (DRIVE PORT)	9
2.3.6 SETTING UP AND FILLING THE FLUID RESERVOIR	9
2.3.6.1 INTERNAL RESERVOIR.....	9
2.3.6.2 EXTERNAL RESERVOIR	11
2.3.7 RESERVOIR RETURN SETTINGS	12
2.3.8 INSTALLING PUMP DRIVE OUT GAS EXHAUST FILTER.....	13
2.3.9 CONNECTING TO OTHER DEVICES	14
2.3.9.1 INSTALLING A LINE FILTER TO PROTECT THE PPCH	14
2.3.9.2 CONNECTING TO AN RPM4 TO BE USED AS AN EXTERNAL REFERENCE DEVICE	14
2.3.9.3 CONNECTING TO A PG7302 PISTON GAUGE	16
2.3.9.4 CONNECTING TO A DEVICE UNDER TEST (TEST PORT)	17
2.3.10 CHECK/SET SECURITY LEVEL	17
2.3.11 TURN OFF ABSOLUTE MEASUREMENT MODE.....	18
2.4 POWER-UP AND VERIFICATION	18
2.4.1 SWITCH POWER ON	18
2.4.2 APPLY PNEUMATIC POWER (DRIVE AIR)	18
2.4.3 CHECK PRESSURE MEASUREMENT OPERATION.....	18
2.4.3.1 CHECKING ABSOLUTE MODE PRESSURE MEASUREMENT.....	18
2.4.3.2 CHECKING GAUGE MODE PRESSURE MEASUREMENT	19
2.4.4 PRIME AND PURGE TEST SYSTEM.....	19
2.4.5 LEAK CHECK	19
2.4.6 CHECK PRESSURE CONTROL OPERATION	19
2.5 STORAGE AND SHIPPING	20
2.5.1 SHORT TERM STORAGE	20
2.5.2 LONG TERM STORAGE	20
2.5.3 PREPARATION FOR SHIPPING.....	20

3.	OPERATION	21
3.1	USER INTERFACE	21
3.1.1	MAIN RUN SCREEN.....	21
3.1.2	FUNCTION / DATA KEYPAD LAYOUT AND PROTOCOL.....	23
3.1.3	DIRECT PRESSURE CONTROL KEYS.....	24
3.1.4	REMOTE [ENT/SET P] (FOOT)SWITCH.....	25
3.1.5	SOUNDS.....	25
3.2	GENERAL OPERATING PRINCIPLES	25
3.2.1	PRESSURE CONTROL PRINCIPLES	25
3.2.2	AUTOMATED PRESSURE CONTROL	28
3.2.2.1	IDLE, NO AUTOMATED CONTROL (MEASURE MODE).....	28
3.2.2.2	DYNAMIC CONTROL	29
3.2.2.3	STATIC CONTROL	30
3.2.2.4	MONOTONIC CONTROL.....	31
3.2.2.5	RAMP CONTROL.....	32
3.2.3	PRESSURE READY/NOT READY	34
3.2.4	GAUGE MEASUREMENT MODE, DYNAMIC COMPENSATION FOR ATMOSPHERIC PRESSURE.....	34
3.2.5	MULTIPLE INTERNAL AND EXTERNAL Q-RPTS	35
3.2.6	MULTI RANGES (Q-RPTS, AUTORANGE AND INFINITE RANGING)	36
3.2.7	FLUID RESERVOIR LOW LEVEL WARNING	37
3.2.8	OPERATION WITH A PG7000 PISTON GAUGE.....	38
3.2.9	DIRECT FUNCTION KEYS SUMMARY	38
3.3	DIRECT FUNCTION KEYS.....	39
3.3.1	[RANGE]	39
3.3.2	[UNIT]	40
3.3.3	[MODE]	41
3.3.4	[AUTORANGE]	42
3.3.5	[RPT].....	44
3.3.6	[AUTOTEST].....	46
3.3.6.1	QUICK AUTOTEST	47
3.3.6.2	QDUT AUTOTEST	49
3.3.7	[HEAD]	52
3.3.8	[PRIME].....	54
3.3.8.1	<1PRIME>.....	55
3.3.8.2	<2PURGE>	56
3.3.9	[LEAK CK]	56
3.3.10	[ENT/SET P] (SET PRESSURE AUTOMATICALLY).....	58
3.3.10.1	DYNAMIC CONTROL MODE, [ENT/SET P].....	58
3.3.10.2	STATIC CONTROL MODE, [ENT/SET P].....	59
3.3.10.3	MONOTONIC CONTROL MODE, [ENT/SET P]	61
3.3.10.4	RAMP CONTROL MODE, [ENT/SET P].....	62
3.3.10.5	INTERRUPTING AUTOMATED PRESSURE CONTROL.....	63
3.3.10.6	AUTOMATED PRESSURE COMMANDS FOR ZERO PRESSURE	63
3.4	[SETUP].....	64
3.4.1	<1RANGE>	64
3.4.1.1	SAVING AN AUTORANGE RANGE	64
3.4.1.2	DELETING AUTORANGE RANGES.....	65
3.4.2	<2RES> (RESOLUTION)	65
3.4.3	<3JOG>	66
3.4.4	<4UL> (UPPER LIMIT)	67
3.4.4.1	OVER PRESSURE FUNCTION	68
3.4.5	<5ATEST>.....	68
3.4.6	<6CONTROL>.....	69
3.4.6.1	<1LIMITS> (CUSTOM CONTROL PARAMETERS)	70
3.4.6.2	<2MODE>	72
3.4.6.3	TURNING-OFF CUSTOM CONTROL PARAMETERS	73
3.4.7	<7DRV> (DRIVERS)	73
3.5	[SPECIAL]	74
3.5.1	<1AUTOZ>	74
3.5.1.1	EDIT AUTOZ	77
3.5.1.2	RUN AUTOZ.....	78
3.5.2	<2REMOTE>.....	79
3.5.2.1	<1COM1, 2COM2>.....	80
3.5.2.2	<3IEEE-488>	80
3.5.2.3	<4FORMAT>	80
3.5.2.4	<5RS232 SELF-TEST>.....	81
3.5.3	<3HEAD>	81
3.5.4	<4RESET>	82
3.5.4.1	<1SETS>.....	82
3.5.4.2	<2UNITS>	83

3.5.4.3	<3ATEST>	83
3.5.4.4	<4CAL>	83
3.5.4.5	<5ALL>	84
3.5.5	<5PREF>	84
3.5.5.1	<1SCRSVR>	85
3.5.5.2	<2SOUND>	85
3.5.5.3	<3TIME>	86
3.5.5.4	<4ID>	86
3.5.5.5	<5LEVEL> (SECURITY)	87
3.5.6	<6PUNIT>	89
3.5.7	<7INTERNAL>	91
3.5.7.1	<1CONFIG>	91
3.5.7.2	<2BARO>	91
3.5.7.3	<3PUMP>	92
3.5.8	<8CAL>	94
3.5.9	<9LOG>	94
4.	REMOTE OPERATION	97
4.1	OVERVIEW	97
4.2	INTERFACING	97
4.2.1	RS232 INTERFACE	97
4.2.1.1	COM1	97
4.2.1.2	IEEE-488	98
4.2.1.3	COM2	98
4.3	PROGRAMMING FORMATS	98
4.3.1	CLASSIC PROGRAM MESSAGE FORMAT	99
4.3.2	ENHANCED PROGRAM MESSAGE FORMAT	99
4.3.2.1	USING COMMAND TYPE COMMANDS	99
4.3.2.2	USING QUERY TYPE COMMANDS	100
4.4	COMMANDS	101
4.4.1	PROGRAMMING MESSAGES	101
4.4.2	ERROR MESSAGES	102
4.4.3	PROGRAM MESSAGE DESCRIPTION OVERVIEW	103
4.4.4	PROGRAM MESSAGE DESCRIPTIONS	104
4.5	STATUS REPORTING SYSTEM	128
4.5.1	ERROR QUEUE	128
4.5.2	STATUS BYTE REGISTER	128
4.5.3	STANDARD EVENT REGISTER	130
4.5.4	READY STATUS REGISTER	130
4.6	IEEE STD. 488.2 COMMON AND STATUS PROGRAM MESSAGES	131
4.6.1	PROGRAM MESSAGE DESCRIPTIONS	131
5.	MAINTENANCE, ADJUSTMENTS AND CALIBRATION	135
5.1	OVERVIEW	135
5.2	PREVENTIVE MAINTENANCE	135
5.3	CALIBRATION OF QUARTZ REFERENCE PRESSURE TRANSDUCERS (Q-RPTS)	137
5.3.1	PRINCIPLE	137
5.3.1.1	PA AND PM COEFFICIENTS	137
5.3.1.2	AS RECEIVED AND AS LEFT DATA	138
5.3.2	EQUIPMENT REQUIRED	139
5.3.3	SET UP AND PREPARATION	139
5.3.4	RECOMMENDED CALIBRATION POINT SEQUENCE	139
5.3.5	TURNING OFF ABSOLUTE MEASUREMENT MODE FOR A Q-RPT	140
5.3.6	Q-RPT CALIBRATION USING CALTOOL FOR RPTS SOFTWARE	141
5.3.7	EDITING AND VIEWING Q-RPT CALIBRATION INFORMATION	141
5.3.8	Q-RPT CALIBRATION/ADJUSTMENT WITHOUT CALTOOL FOR RPTS SOFTWARE	143
5.4	ADJUSTMENT OF ON-BOARD BAROMETER	144
5.5	ADJUSTMENT OF UTILITY SENSOR	144
5.6	FILLING AND DRAINING THE FLUID RESERVOIR	145
5.6.1	INTERNAL RESERVOIR	145
5.6.1.1	FILLING THE INTERNAL RESERVOIR	145
5.6.1.2	DRAINING THE INTERNAL RESERVOIR	146
5.6.2	EXTERNAL RESERVOIR	146
5.6.2.1	FILLING THE EXTERNAL RESERVOIR	146
5.6.2.2	DRAINING THE EXTERNAL RESERVOIR	147

5.6.3	PURGING CONTAMINATED FLUID FROM THE PPCH.....	148
5.7	VOLUME CONFIGURATION.....	148
5.8	VALVE OPENING POINT CONFIGURATION.....	150
5.9	ACCESSING PPCH MECHANICAL MODULE.....	151
5.10	HYDROPNEUMATIC PUMP.....	152
5.10.1	PRIMING THE PUMP.....	152
5.10.1.1	PRIMING THE PUMP CHECK VALVE.....	153
5.10.2	PUMP REPLACEMENT.....	154
5.10.3	PUMP SPOOL VALVE INSPECTION OR REPAIR.....	156
5.10.4	PUMP INLET FILTER (LIQUID) REPLACEMENT.....	158
5.11	LEAK CHECKING.....	159
5.11.1	PRESSURE DECAY LEAK TESTING METHOD.....	159
5.11.2	LOCALIZING A LEAK WITHIN THE PPCH.....	160
5.11.2.1	HIGH PRESSURE VENT VALVE LEAK.....	161
5.11.2.2	LOW PRESSURE ISOLATION VALVE LEAK.....	163
5.11.2.3	LOW PRESSURE VENT VALVE LEAK.....	163
5.12	VALVE REPLACEMENT OR REPAIR.....	165
5.12.1	SHUTOFF VALVE REPLACEMENT.....	165
5.12.2	CONTROL VALVE SERVICE.....	166
5.13	RELOADING EMBEDDED SOFTWARE INTO FLASH MEMORY.....	166
5.14	SUBASSEMBLY DESCRIPTION AND LOCATION.....	167
5.14.1	ELECTRONIC MODULE.....	167
5.14.1.1	POWER ENTRY AND FUSE.....	167
5.14.1.2	POWER SUPPLIES.....	167
5.14.1.3	DRIVER BOARD.....	168
5.14.1.4	MINI MICRO BOARD.....	168
5.14.1.5	ON-BOARD BAROMETER.....	168
5.14.2	MECHANICAL MODULE.....	169
5.14.2.1	PUMP DRIVE AIR PRESSURE TRANSDUCER.....	169
5.14.2.2	HI Q-RPT OR UTILITY SENSOR.....	169
5.14.2.3	TEST VENT VALVE.....	170
5.14.2.4	LO Q-RPT SHUTOFF VALVE.....	170
5.14.2.5	LO Q-RPT.....	170
5.14.2.6	LO Q-RPT VENT VALVE.....	170
5.14.2.7	PUMP ACCUMULATOR.....	170
5.14.2.8	FRONT PANEL.....	170
5.14.2.9	ELECTRICAL CABLE TRACK.....	170
5.14.2.10	HYDROPNEUMATIC PUMP.....	170
5.14.2.11	INLET CONTROL VALVE.....	170
5.14.2.12	OUTLET CONTROL VALVE.....	171
5.14.2.13	FLUID RESERVOIR.....	171
5.14.2.14	RESERVOIR OVERFLOW/EXTERNAL RESERVOIR RETURN TUBE.....	171
5.14.2.15	THERMAL PRESSURE CONTROL UNIT (TPCU).....	171
5.14.2.16	DRIVE PRESSURE REGULATOR.....	171
6.	TROUBLESHOOTING.....	173
7.	APPENDIX.....	177
7.1	DRIVERS.....	177
7.2	UNIT CONVERSION.....	178
7.2.1	PRESSURE.....	178
7.3	REMOTE [ENT].....	178
8.	WARRANTY.....	179
8.1	OVERVIEW.....	179
9.	GLOSSARY.....	181

TABLES

Table 1. Reference pressure transducer (Q-RPT) designations and ranges	3
Table 2. PPCH packing list	5
Table 3. Drive air requirements.....	9
Table 4. Reservoir return settings for internal or external reservoir	13
Table 5. MAIN RUN screen display fields.....	22
Table 6. Position designators of Q-RPTs in a PPCH system	36
Table 7. Settings and to what they are specific (range, measurement mode, Q-RPT, system)	37
Table 8. Summary of PPCH function key operation	38
Table 9. Settings made by AutoRange	43
Table 10. Default pressure control parameters	70
Table 11. AutoZ ON and OFF	76
Table 12. Reset – Sets.....	83
Table 13. Reset – Cal	84
Table 14. Reset – All.....	84
Table 15. Security levels	88
Table 16. UNIT function - available units of measure.....	90
Table 17. COM1 pin designations and connections	97
Table 18. COM2 DB-9F pin designations	98
Table 19. Program message list	101
Table 20. Error numbers (#) and descriptions	102
Table 21. 8 Bit status byte register	128
Table 22. 8 bit standard event register	130
Table 23. 8 bit ready status register.....	130
Table 24. Program message list	131
Table 25. PPCH maintenance parts	136
Table 26. Calibration point sequence, standard class, Q-RPTs.....	140
Table 27. Troubleshooting guide	173
Table 28. External drivers current output.....	177
Table 29. External drivers pin outs	177
Table 30. Pressure unit of measure conversion coefficients.....	178
Table 31. DHI Authorized Service Providers	179

FIGURES

Figure 1. Front panel.....	7
Figure 2. Rear panel	8
Figure 3. Internal reservoir setup	11
Figure 4. External reservoir setup.....	12
Figure 5. Installing the exhaust filter/muffler	13
Figure 6. Connecting PPCH to an RPM4 or PG7302 using the standard PPCH interconnection accessories	16
Figure 7. Keypad layout	23
Figure 8. Direct pressure control keys	24
Figure 9. Pressure control system schematic.....	27
Figure 10. Dynamic pressure control operation.....	29
Figure 11. <i>Ready/Not Ready</i> in dynamic pressure control mode	30
Figure 12. Static pressure control operation.....	30
Figure 13. <i>Ready/Not Ready</i> in static control mode	31
Figure 14. Monotonic pressure control operation	32
Figure 15. <i>Ready/Not Ready</i> in monotonic pressure control mode.....	32
Figure 16. Ramp pressure control operation	33
Figure 17. <i>Ready/Not Ready</i> in ramp pressure control mode	33
Figure 18. Status register schematic	129
Figure 19. Internal reservoir schematic	146
Figure 20. External reservoir schematic	147
Figure 21. Electronic module, internal view	167
Figure 22. Mechanical module, internal view.....	169
Figure 23. Drivers connector schematic	177
Figure 24. Remote [ENT/SET P] connector schematic	178

ABOUT THIS MANUAL

This manual is intended to provide the user with the basic information necessary to operate a PPCH pressure controller/calibrator. It also includes a great deal of additional information provided to allow you to optimize PPCH use and take full advantage of its many features and functions.

Before using the manual, take a moment to familiarize yourself with the Table of Contents structure: Sections 1, 2 and 3 should be read by all first time PPCH users. Section 3 is most important for those using the local front panel interface but should be read over by all users to familiarize themselves with general PPCH operating principles. Section 4 is for remote operation from an external computer. Section 5 provides maintenance and calibration information. Section 6 is a quick troubleshooting guide. Use it to troubleshoot unexpected PPCH behavior based on the symptom of that behavior. Certain words and expressions have specific meaning as they pertain to PPCH. The Glossary, Section 9, is useful as a quick reference for exact definition of specific words and expressions as they are used in the manual.



For those of you who “don’t read manuals”, go directly to Section 2.3 to set up your PPCH and then go to Section 2.4 for power-up and verification. This will get you up and running quickly with a minimal risk of causing damage to yourself or your new PPCH. THEN... when you have questions or start to wonder about all the great features you might be missing, get into the manual!



(CAUTION) is used in throughout the manual to identify user warnings and cautions.



(NOTE) is used throughout the manual to identify operating and applications advice and additional explanations.

[] indicates direct function keys (e.g., **[RANGE]**).
< > indicates PPCH screen displays (e.g., <1yes>).

NOTES

1. INTRODUCTION

1.1 PRODUCT OVERVIEW

PPCH is a stand-alone, pressure controller intended to precisely generate, adjust and control hydraulic pressure into a closed volume as is commonly needed for the calibration and testing of pressure measuring instruments. It has been designed to provide very high performance combined with maximum versatility and ease of use.

PPCH can be equipped with a low cost utility sensor for pressure monitoring or one or two Quartz Reference Pressure Transducers (Q-RPTs) to allow it to set and measure pressure with higher precision and very low measurement uncertainty. Up to four external Q-RPTs in one or two external Reference Pressure Monitors (RPM4s), can also be integrated into a PPCH system. A barometer is also included for atmospheric pressure compensation of gauge mode measurements and as a reference for AutoZero in absolute measurement mode.

PPCH generates high liquid pressure internally using a hydropneumatic pump driven by a drive air supply. Pressure control is achieved by servo-motor controlled, high pressure needle valves and a thermal pressure control system.

PPCH is controlled locally by the operator using a front panel display, keypad and function keys or remotely by a computer using ASCII character command strings over an RS232 or IEEE-488.2 interface.

PPCH models are available to measure and control pressure in ranges from as low as 20 MPa (3 000 psi) to 200 MPa (30 000 psi) in absolute and gauge measurement modes.

1.2 SPECIFICATIONS

1.2.1 GENERAL SPECIFICATIONS

Power Requirements	85 to 264 VAC, 50/60 Hz, 75 W max consumption
Operating Temperature Range	15 to 35 °C
Storage Temperature Range	- 20 to 70 °C
Vibration	Meets MIL-T-28800D
Weight	50 kg (110 lb) approx
Dimensions	Without optional enclosure: 26 cm H x 44 cm W x 55.5 cm D (10.2 in. x 17.3 in. x 21.9 in.) Front panel is 19" wide X 6U high with mounting holes for standard 19 in. rack mount systems With optional enclosure: 30 cm H x 52 cm W x 55.5 cm D (11.8 in. x 20.5 in. x 21.9 in.)
Ventilation	To prevent product overheating, provide proper ventilation. Allow 10 cm (4 in.) clearance from rear panel cooling fan.
Communication Ports	RS232 (COM1), RS232 (COM2), IEEE-488.2
Fuses	1 A, 250 VAC fuse, 5 x 20 mm, time lag type fuse Internal power supply fuse not replaceable by operator: 2A, 250 V (UV 440-2 power supply), 3.15A, 250 V (NFS40-7612 power supply)
Pressure Ranges	Four controller models from 70 MPa (10 000 psi max to 200 MPa (30 000 psi) max. Low uncertainty measurement provided by selection of Quartz Reference Pressure transducer(s) (Q-RPTs)
Operating Medium	Di-2-Ethyl Hexyl Sebacate (other fluids optional)
Internal Reservoir Capacity	300 cc
Pressure Connections	DRIVE: 1/8 in. NPT F TEST: DH500 F <i>NOTE: DH500 is a gland and collar type fitting for 1/4 in. (6.35 mm) coned and left hand threaded tube. DH500 is equivalent to AE F250C, HIP HF4, etc.</i> EXTERNAL: 1/8 in. NPT F OVERFLOW: 1/8 in. NPT F FILL/DRAIN: 1/4 in. swage M ATM: 10-32 UNF
Pressure Limits	Maximum Working Test Pressure: Controller or Hi Q-RPT maximum Maximum Test Pressure without Damage: 115 % controller or Hi Q-RPT maximum Required Drive Air Pressure Supply: H-70M: 500 kPa (75 psi) min, 850 kPa (120 psi) max; 330 l/m (10 cfm) H-100M: 700 kPa (100 psi) min, 850 kPa (120 psi) max; 330 l/m (10 cfm) H-140M: 500 kPa (75 psi) min, 850 kPa (120 psi) max; 450 l/m (15 cfm) H-200M: 700 kPa (100 psi) min, 850 kPa (120 psi) max; 450 l/m (15 cfm)

1.2.2 PRESSURE MEASUREMENT SPECIFICATIONS

1.2.2.1 QUARTZ REFERENCE PRESSURE TRANSDUCER (Q-RPT)

Quartz reference pressure transducers (Q-RPTs) can be installed in PPCH to obtain high precision and low uncertainty pressure measurement. One or two Q-RPTs can be included in the PPCH and/or additional Q-RPTs can be used externally mounted in **DHI RPM4 Reference Pressure Monitors** (see Section 3.2.5).

All PPCH Q-RPTs are of the absolute pressure type (Axxx) using an evacuated, permanently sealed reference. Axxx Q-RPTs used in PPCH can measure absolute and gauge pressure. Gauge pressure with an Axxx (absolute) Q-RPT is obtained by offsetting atmospheric pressure and applying dynamic compensation for atmospheric changes using the on-board barometer (see Section 3.2.4). See Section 3.3.3, ○ PRINCIPLE, for additional information on absolute and gauge measurement modes.

PPCHs configured with two Q-RPT modules have only one **TEST** port. PPCH internal valves and logic handle switching between the two Q-RPTs as needed.

Table 1. Reference pressure transducer (Q-RPT) designations and ranges

RPT DESIGNATION	SI VERSION	US VERSION
	MAXIMUM PRESSURE Absolute and Gauge [MPa]	MAXIMUM PRESSURE Absolute and Gauge [psi]
A200M	200	30 000
A140M	140	20 000
A100M	100	15 000
A70M	70	10 000
A40M	40	6 000
A20M	20	3 000

Warm Up Time 30 minute temperature stabilization recommended for best performance from cold power up.

Resolution To 1 ppm, user adjustable

Compensated Temperature Range 5 to 35 °C

Acceleration Affect ± 0.008 % /g maximum, worst axis
Allows operation at ± 20° from reference plane without significant effect

	<A200M	A200M
Precision¹	± 0.012 % of reading ⁵	± 0.015 % of reading ⁵
Predicted Stability²	± 0.005 % of reading ⁵	± 0.005 % of reading ⁵
Measurement Uncertainty³	± 0.013 % of reading ⁵	± 0.018 % of reading ⁵
Delivered Pressure Uncertainty⁴	± 0.015 % of reading ⁵	± 0.020 % of reading ⁵

1. Combined linearity, hysteresis, repeatability.

2. Predicted Q-RPT measurement stability limit (k=2) over one year assuming regular use of AutoZero function. AutoZero occurs automatically in gauge mode whenever vented, by comparison with barometric reference in absolute mode. Absolute mode predicted one year stability without AutoZ is ± (0.005 % Q-RPT span + 0.005 % of reading).

3. Maximum deviation of the Q-RPT indication from the true value of applied pressure including precision, predicted one year stability limit, temperature effect and calibration uncertainty, combined and expanded (k=2) following the ISO "Guide to the Expression of Uncertainty in Measurement."

4. Maximum deviation of the PPCH controlled pressure from the true value including measurement uncertainty and dynamic control hold limit.

5. % of reading applies to 30 to 100 % of Q-RPT span. Under 30 % of Q-RPT span, the value is a constant which is the % of reading value times 30 %.

1.2.2.2 UTILITY SENSOR

Base PPCH pressure controllers include a utility sensor. If a Hi Q-RPT (see Section 3.2.5) is installed, there is no utility sensor.

Utility sensors are used for pressure control, system monitoring and safety functions. They are intended for indication only, not to provide reference pressure measurement. Q-RPTs (see Section 1.2.2.1) are used for reference measurement.

Warm Up Time	None required
Range	PPCH-70M: 70 MPa (10 000 psi) absolute and gauge PPCH-100M: 100 MPa (15 000 psi) absolute and gauge PPCH-140M: 140 MPa (15 000 psi) absolute and gauge PPCH-200M: 200 MPa (30 000 psi) absolute and gauge
Resolution	0.001 % of span
Precision	0.1 % of span

1.2.2.3 ON-BOARD BAROMETER

The on-board barometer is used only to measure changes in atmospheric pressure to provide dynamic compensation of the Q-RPT's atmospheric pressure offset when operating in gauge measurement mode. If calibrated, it can also be used as an AutoZ reference for AutoZeroing in absolute measurement mode.

Warm Up Time	None required
Range	70 to 110 kPa (10 to 16 psi)
Resolution	0.001 % of span
Precision	0.1 % of span
Predicted Stability	0.05 kPa/yr (0.008 psi/yr)

1.2.3 PRESSURE CONTROL SPECIFICATIONS

	ALL MODELS
Control Precision (Standard Dynamic Mode)	to ± 0.003 % of Q-RPT span
Default Dynamic Control Hold Limit	± 0.01 % of AutoRanged range
Lowest Controllable Pressure (absolute, gauge modes)	1 MPa (150 psi)
Typical Control Ready Time (Dynamic Mode)	60 to 120 seconds.
Slew Rate (0 to FS)	60 seconds
TEST Volume	0 to 100 cc, 50 cc optimum (operates in larger volumes but pressure stabilizing time increases)

2. INSTALLATION

2.1 UNPACKING AND INSPECTION

2.1.1 REMOVING FROM PACKAGING

PPCH is delivered in a wooden crate with high density polyethylene inserts to hold it in place. Remove the PPCH and its accessories from the shipping container and remove each element from its protective plastic bag.



PPCH weighs more than 50 kg (110 lb). Take appropriate precautions to lift and place it safely.

2.1.2 INSPECTING CONTENTS

Check that all items are present and have no visible damage. A standard PPCH includes all items indicated in Table 2.

Table 2. PPCH packing list

DESCRIPTION		PART #
1 ea.	PPCH Pressure Controller/Calibrator	FAM0010
1 ea.	PPCH Enclosure (optional)	06-01
ACCESSORIES:		402038 (402038-CE)
1 ea.	Operation and Maintenance Manual	550132
1 ea.	Calibration Report	550100
1 ea.	Test Report	550200
1 ea.	Power Cord (7.5 ft.)	100770 (100770-CE)
1 ea.	Reservoir fill tube assembly	402039
1 ea.	Reservoir fill tube bracket	123832
2 ea.	Bolts, SHC, M3 x 8	101010-Z
1 ea.	Funnel	123959
1 ea.	Filter/muffler, pump drive exhaust, 1/4. in. NPT M	103897
1 ea.	Gland, DH200	100272
1 ea.	Plug, DH200	100279
1 qt.	Sebacate (synthetic oil). If PPCH is delivered filled with a fluid other than Sebacate, this item is not included.	400503 or none
1 ea.	Drivers Connector	401382
1 ea.	General Accessories Disk (white CD)	102987
INTERCONNECTIONS KIT:		401536
2 ea.	Nipple, 2.75 in., DH500	100207
1 ea.	Nipple, 6 in., DH500	100208
2 ea.	Nipple, 12 in., DH500	100209
1 ea.	Union, DH500	100295
1 ea.	Elbow, DH500	100168
1 ea.	Tee, DH500	100291
2 ea.	Gland, DH500	100271
3 ea.	Plug, DH500	100285
5 ea.	Collar, DH500	101201
1 ea.	Nipple, 5 in. x 1/8 in., DH500 tips	123019
2 ea.	Adaptor, DH500 F x 1/8 in. NPT M	102819
1 ea.	Adaptor, DH500 F x 1/4 in. NPT F	102820

2.2 SITE REQUIREMENTS



PPCH weighs more than 50 kg (110 lb). Be sure that the location in which it's installed is adequate to support the load.

The PPCH can be installed on any **flat, stable surface** at a convenient height. The PPCH can also be mounted in a standard 19 in. rack (see Section 2.2.1).

Minimizing the distance between the PPCH and the device or system under test will enhance control performance and reduce pressure setting times.

Ready access to the PPCH rear panel should be considered to facilitate making and breaking pressure connections.

Also consider:

- Access to the internal reservoir **FILL/DRAIN** port if an external reservoir is not being used (see Section 2.3.6).
- Location and connections to an external reservoir, if used (see Section 2.3.6.2).
- Hydraulic and RS-232 connections to an external RPM4 should be considered if RPM4 is to be used as an external reference pressure measurement device (see Section 2.3.9.1).
- Location and connections to the device or system into which pressure is to be controlled (see Section 2.3.9.4).

Support facilities required include:

- **An electrical power source** of 85 to 264 VAC, 50/60 Hz.
 - **A pneumatic power supply**, of “drive air” to be connected to the PPCH **DRIVE** port. Required pressure varies with PPCH model (see Section 2.4.2).
-



ALWAYS use external tubing and fittings rated for pressures equal to or greater than the maximum pressure PPCH will generate.

2.2.1 INSTALLATION IN A 19 IN. RACK MOUNT

PPCH is dimensioned to be ready for direct mounting in a standard 19 in. rack mount system.

If PPCH was delivered in the optional enclosure, it must be removed from the enclosure prior to rack mounting.

The front panel is 6U (10.5 in.) high.

Install PPCH into the rack mount system using heavy duty front panel bolts provided by the rack vendor. Due to PPCH's weight, it is imperative that a rail system also be used to support it along the sides and/or rear. These are also supplied by the rack mount system vendor.



PPCH weighs more than 50 kg (110 lb). Take appropriate precautions to lift and place it safely. It is the user's responsibility to support PPCH adequately on the sides and/or rear when installing it in a rack mount system.

2.3 INITIAL SETUP

2.3.1 PREPARING FOR OPERATION

To prepare PPCH for check out and operation:

- ❶ Remove the plastic caps from the PPCH rear panel pressure connections.
- ❷ Remove the protective plastic sheet from the front panel display.
- ❸ Familiarize yourself briefly with the front and rear panel (see Section 2.3.2).

Then proceed with Sections 2.3.3 to 2.3.11.

2.3.2 FRONT AND REAR PANELS

2.3.2.1 FRONT PANEL

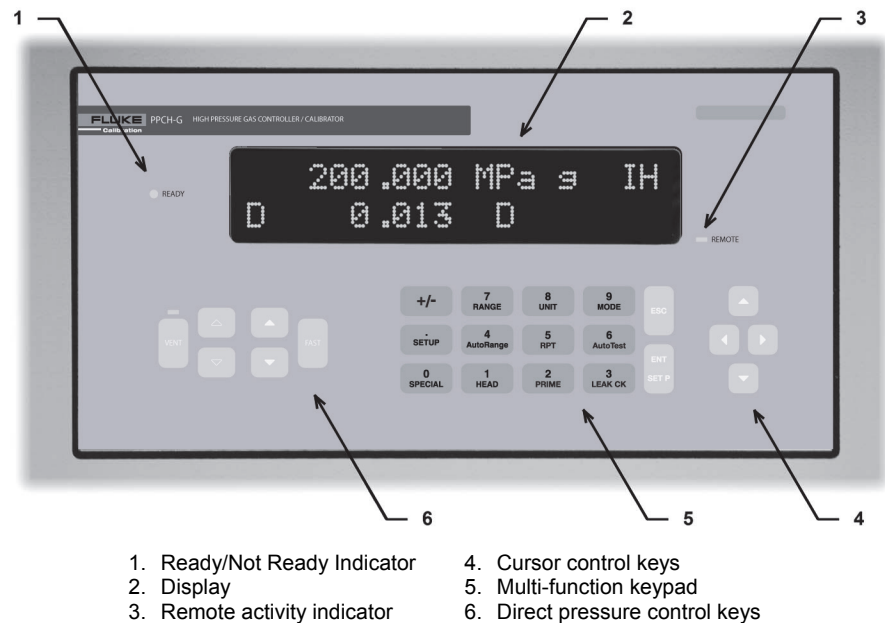

Figure 1. Front panel

2.3.2.2 REAR PANEL

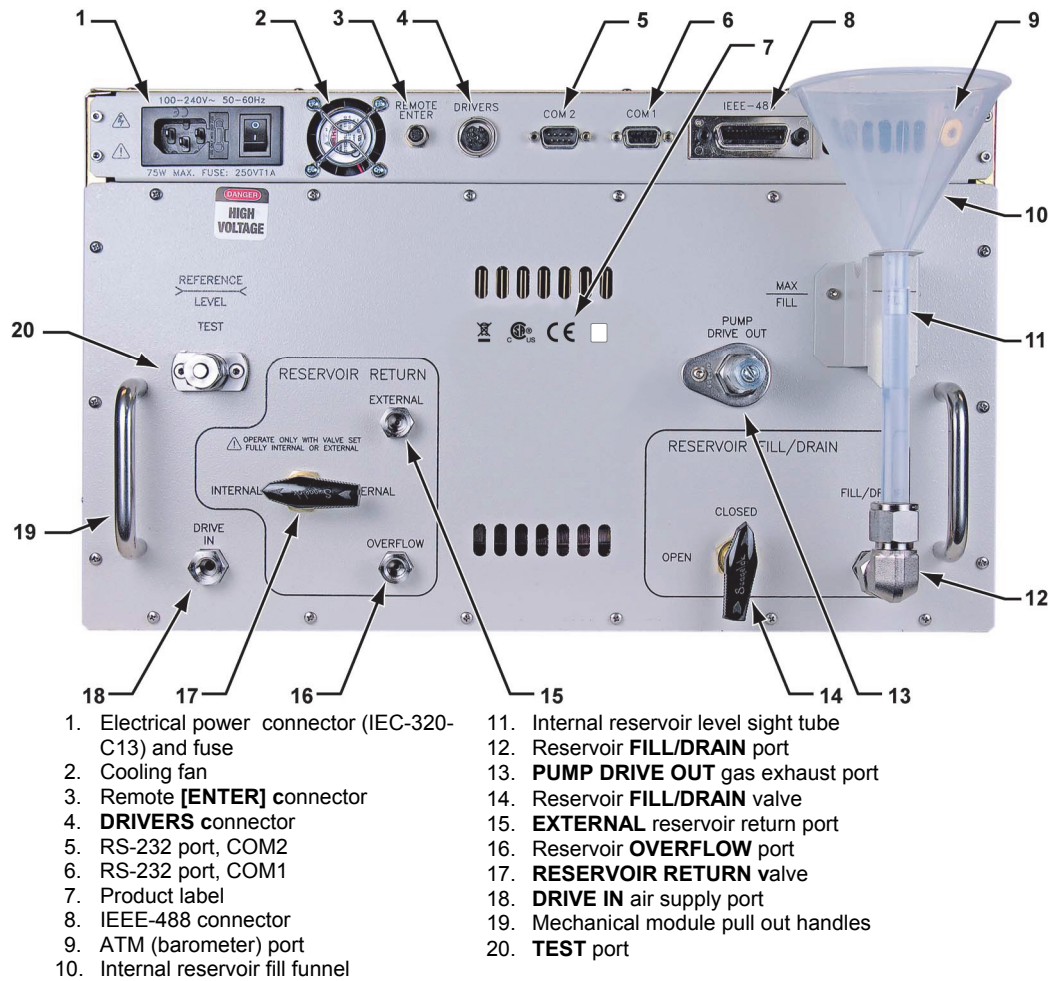

Figure 2. Rear panel

2.3.3 POWER CONNECTION

- ❶ Check that the PPCH power switch is OFF.
- ❷ Connect the supplied power cable to the rear panel power input module.
- ❸ Connect the other end of the power cable to an electrical supply of 85 to 264 VAC, 50/60 Hz.

2.3.4 REMOTE [ENTER/SET P] CONNECTION (FOOTSWITCH OR OTHER SWITCH)

Connect the optional remote ENTER footswitch, if available or a user supplied switch fitted to the optional cable (see Section 7.3). Connect the cable to the PPCH rear panel connection labeled **REMOTE ENTER**. Activating the switch is equivalent to pressing the **[ENT/SET P]** key on the front panel (see Section 3.1.4).

2.3.5 CONNECTING PNEUMATIC POWER (DRIVE PORT)

Using a pressure connecting hose or tube of appropriate pressure rating, connect drive air supply to the **DRIVE** port on the rear panel of PPCH. It is important to proper PPCH pressure control that the supply connection not excessively restrict flow. The tube should have an ID of at least 3 mm (1/8 in.) and not be more than 2 m (6 ft) long. Generally, a 3 mm ID tube has OD of at least 6.35 mm (1/4 in.). The **DRIVE** port connection is **1/8 in. NPT female**.

The drive air supply is regulated internally by PPCH. Drive air requirements for the different PPCH models are listed in Table 3.

Table 3. Drive air requirements

MODEL	MINIMUM DRIVE AIR PRESSURE	MAXIMUM DRIVE AIR PRESSURE	MINIMUM UNINTERRUPTED FLOW
PPCH-70M	500 kPa (75 psi)	850 kPa (120 psi)	330 l/m (10 cfm)
PPCH-100M	700 kPa (100 psi)		
PPCH-140M	500 kPa (75 psi)		450 l/m (15 cfm)
PPCH-200M	700 kPa (100 psi)		

2.3.6 SETTING UP AND FILLING THE FLUID RESERVOIR

The PPCH fluid reservoir holds the fluid that supplies PPCH's hydropneumatic pump and returns from its exhaust valve.

PPCH has an internal reservoir with a capacity of 300 cc that is filled from and whose level can be viewed on the rear panel of the instrument. If greater capacity and/or remote reservoir filling and level viewing are needed, external reservoir (part number 402102) may be installed.

See Section 2.3.6.1 to set up and fill the internal reservoir.

See Section 2.3.6.2 to set up and fill an external reservoir.

 *Take care not to let the PPCH reservoir become empty. Operating PPCH with an empty reservoir will cause the hydropneumatic pump to draw air and lose its prime. A pump that has lost its prime must be reprimed using a special procedure (see Section 5.10.1). PPCH has a low fluid level warning displayed on the front panel that can be also checked by remote command (see Section 3.5.7.3).*

 *The system connected to the TEST port is connected to the reservoir when the PPCH is vented ([VENT] LED ON). If there is an open point in the system below the fluid level in the reservoir, liquid will run from the reservoir and out of the open point.*

2.3.6.1 INTERNAL RESERVOIR

The PPCH is shipped with its internal reservoir filled with PPCH's working fluid.

To operate without an external reservoir, the internal reservoir attachments must be installed on the PPCH rear panel. These are included with the PPCH accessories (see Table 2).

The internal reservoir attachments include:

- Reservoir fill tube bracket, p/n 123832 (grey painted bracket)
- (2) M3 x 8 bolts, p/n 101010-Z
- Reservoir fill tube assembly, p/n 402039 (1/2 in. PFA tube with fittings attached)
- Funnel p/n 123959



To prevent draining the reservoir accidentally, leave the **RESERVOIR FILL/DRAIN** valve in the **CLOSED** position whenever the internal reservoir or external reservoir attachments are not installed. Opening the **FILL/DRAIN** valve opens the **FILL/DRAIN** port to the reservoir.

To set up to use the internal reservoir without an external reservoir, proceed as follows (numeric references refer to Figure 3):

- ❶ Install the reservoir fill tube bracket(1) to the PPCH rear panel using 2 ea. M3 x 8 bolts(3).
- ❷ Install the reservoir fill tube assembly(4) by connecting the 1/4 in. swage female on the assembly to the 1/4 in. swage male **FILL/DRAIN** connection. Remove and retain the stainless steel cap that is installed on the connection as delivered. Orient the PFA tube vertically. Bend the tube slightly to extend through the reservoir fill bracket.
- ❸ There is a red plug with a center pull tab in the end of the PFA tube. This should be left in place when the funnel is not being used to prevent contamination and/or evaporation of the fluid. The funnel(2) can be stored in the holder just behind the tube.
- ❹ Open the **FILL/DRAIN** valve(5). Fluid may enter the fill drain tube(4).
- ❺ Check that the **EXTERNAL** port(6) is plugged. It is plugged when delivered. If it is not, use a 1/8 in. NPT M plug with Teflon® tape on the threads to plug it. Not plugging the **EXTERNAL** port when using the internal reservoir only will cause the fluid exhausted from the PPCH to leak out rather than returning to the reservoir.
- ❻ Check that the **OVERFLOW** port(7) is open to atmosphere and unobstructed. This assures the reservoir is open to atmosphere so proper system venting and zeroing can occur.
- ❼ Be sure the **RESERVOIR RETURN** valve(8) is on the **INTERNAL** position.
- ❽ Check the level of the fluid in the fill/drain tube. If the level is below the **MAX FILL** position, top off the tank. See Section 5.6.1 for information on filling and draining the PPCH internal reservoir.



The PFA reservoir fill tube is delivered with a red plug with a center pull tab installed. This plug can be used after the tube is installed to cover the opening and reduce evaporation of the fluid. The plug is vented.

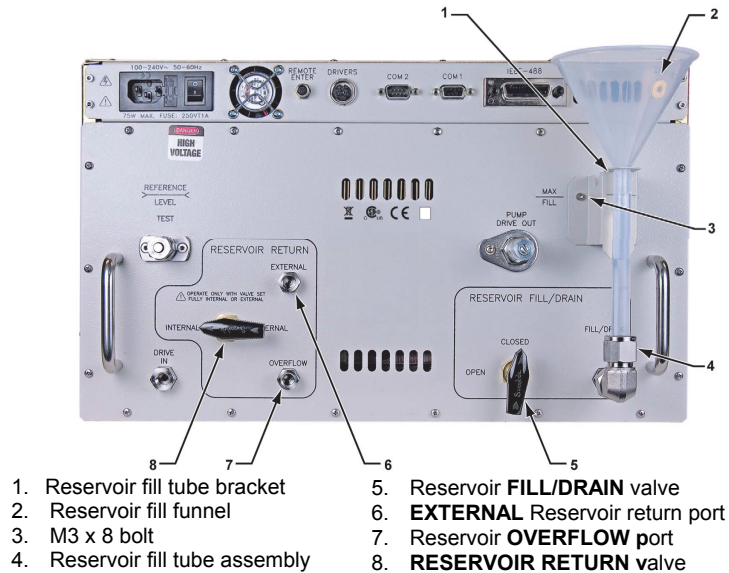

Figure 3. Internal reservoir setup

2.3.6.2 EXTERNAL RESERVOIR

The PPCH is shipped with its internal reservoir filled with PPCH's working fluid.

An external reservoir, if desired, is connected in series to supply the internal reservoir so that the internal reservoir's features are still available.

When using an external reservoir the internal reservoir attachments are NOT installed. If they have been installed, remove them prior to setting up the external reservoir (see Section 2.3.6.1). Be sure to put the **FILL/DRAIN** valve in the **CLOSED** position before removing the fill/drain tube assembly.



To prevent draining the reservoir accidentally, leave the **RESERVOIR FILL/DRAIN** valve in the **CLOSED** position if the internal or external reservoir attachments are not installed. Opening the **FILL/DRAIN** valve opens the **FILL/DRAIN** port to the internal reservoir.

When installing an external reservoir, the bottom of the reservoir should be higher than the PPCH instrument. Avoid low points in the tubing between the PPCH and the external reservoir.

To set up to use an external reservoir, proceed as follows (numerical references refer to Figure 4):

- ❶ With the reservoir **FILL/DRAIN** valve in the **CLOSED** position, connect a tube coming from the bottom of the external reservoir to the **FILL/DRAIN** port(1). The **FILL/DRAIN** port is 1/4 in. M swage.
- ❷ Connect an external reservoir return tube from the **EXTERNAL** port(3) to the inside of the reservoir. Remove and retain the 1/8 in. NPT plug installed in **EXTERNAL** port as shipped. The reservoir return tube returns fluid exhausted by PPCH to the external reservoir. The top of the tube should extend vertically to a level slightly higher than the top surface of the fluid in the reservoir. The top of the tube defines the fluid head applied to the PPCH Q-RPT when the PPCH is vented (see Section 5.6.2, Figure 20).

- ③ Fill the external reservoir with fluid. This should be the same fluid that is in the PPCH. PPCH will not operate properly with a fluid other than the liquid with which it was filled when delivered. The **MAX FILL** label on the rear of the PPCH does not apply when using an external reservoir.
- ④ Purge air from the internal reservoir and overflow circuit:
 - a. Prepare an 1/8 in. NPT plug (one was delivered installed in the **EXTERNAL** port) by wrapping its threads with Teflon tape.
 - b. While watching the **OVERFLOW** port(4), slowly turn the **RESERVOIR FILL/DRAIN** valve(2) to the **OPEN** position.
 - c. When air free fluid begins to flow from the **OVERFLOW** port, plug the port with the 1/8 in. NPT plug.
- ⑤ Be sure the **RESERVOIR RETURN** valve(5) is in the **EXTERNAL** position.
- ⑥ Be sure the external reservoir is open to atmosphere so proper system venting and zeroing can occur.
- ⑦ Fill the reservoir return tube connected between the reservoir and the **EXTERNAL** port with fluid. See Section 5.6.2 for additional information in filling and draining an external reservoir.

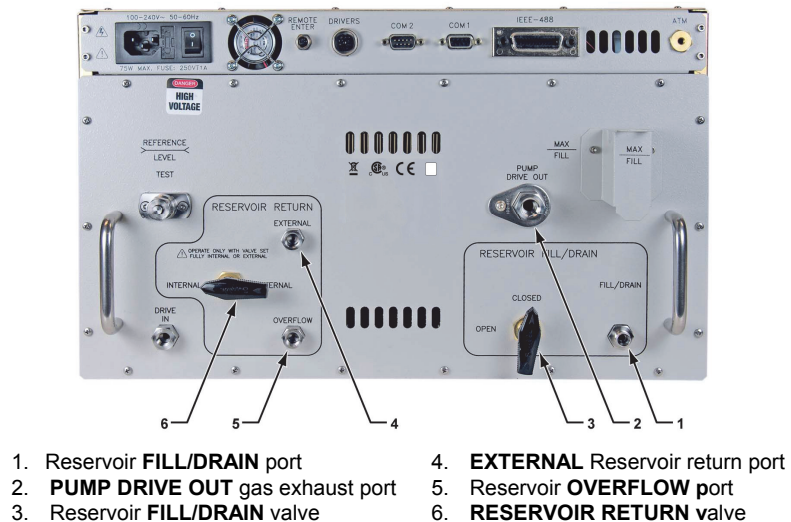



Figure 4. External reservoir setup

 When the PPCH is vented ([YENT] LED ON), the system connected to the TEST port is connected to the reservoir. If there is an open point in the system below the fluid level in the reservoir, liquid will run out of the reservoir through the open point.

2.3.7 RESERVOIR RETURN SETTINGS

The PPCH rear panel has a section labeled **RESERVOIR RETURN**. The settings and connections in this panel vary depending on whether the internal reservoir is being used alone or an external reservoir is being used.

Refer to Table 4 for correct reservoir return settings and other conditions when using the internal reservoir alone or an external reservoir. Also see Section 2.3.6 for internal and external reservoir setups.

Table 4. Reservoir return settings for internal or external reservoir

RESERVOIR	RESERVOIR RETURN VALVE POSITION	OVERFLOW PORT	EXTERNAL PORT
Internal only	INTERNAL	Open to atmosphere	Plugged
External	EXTERNAL	Plugged	Connected to external reservoir return tube



See Section 5.6, Figure 19 and Figure 20 for schematics of the PPCH reservoir system.



Incorrect settings or port conditions in the RESERVOIR RETURN panel may lead to fluid leaks and faulty measurements.

2.3.8 INSTALLING PUMP DRIVE OUT GAS EXHAUST FILTER/MUFFLER

A stainless steel filter (P/N 103897) is supplied in the PPCH accessory kit. The filter dampens the sound of supply gas being exhausted from the hydro-pneumatic pump. To install the filter, first wrap 1 to 2 turns of teflon tape around the threads then insert the threaded end of the muffler into the Pump Drive Out port using a 9/16" wrench as shown in Figure 5. Do not overtighten.



It is important to use a wrench to install the filter instead of a screwdriver. The button head screw on the end of the filter adjusts the conductance of the muffler. If the muffler is too restrictive then the hydropneumatic pump will stall and the PPCH may not be able to increase pressure.



The filter/muffler is adjusted for conductance at the factory. If the filter adjustment is altered it can be returned to the factory setting by using a screwdriver to turn the button head screw clockwise until it stops then turning it one and half turns counterclockwise.



Figure 5. Installing the exhaust filter/muffler

2.3.9 CONNECTING TO OTHER DEVICES



ALWAYS use external tubing and fittings rated for pressure equal to or greater than the maximum pressure PPCH will be used to generate.

The PPCH **TEST** port is a DH500 female fitting.



DH500 is a gland and collar type fitting for 1/4 in. (6.35 mm) coned and left hand threaded tube. DH500 is equivalent to AE F250C, HIP HF4, etc.

DH500 fittings are rated for working pressure up to 500 MPa (72 500 psi). Be sure to use stainless steel tubing rated for your maximum operating pressure with the DH500 fittings.

2.3.9.1 INSTALLING A LINE FILTER TO PROTECT THE PPCH

PPCH uses pressure shutoff valves that are needle valves that close by the metal to metal contact of the needle in its seat. These valves can be damaged by hard particles. If the test system to which PPCH will be connected may contain hard particles, such as metal shavings from a production process, a line filter should be installed on the PPCH test port to prevent the particles from entering the PPCH when reducing pressure. The filter should not be smaller than 40 micron. DHI recommends high pressure filter kit p/n 402376.

2.3.9.2 CONNECTING TO AN RPM4 TO BE USED AS AN EXTERNAL REFERENCE DEVICE



ALWAYS use external tubing and fittings rated for pressure equal to or greater than the maximum pressure PPCH will be used to generate.

PPCH can be connected hydraulically and by RS-232 to one or two RPM4 reference pressure monitors to use up to four external Q-RPTs (two in each RPM4) as external reference pressure measurement devices (see Section 3.2.5).

The PPCH then manages communications and other RPM4 functions to integrate the RPM4 measurement capabilities into the PPCH system. **The user is responsible for setting up hardware and following procedures to isolate lower pressure Q-RPTs from possible overpressure if pressures higher than the Q-RPT maximum are generated..** PPCH and RPM4 do not have hardware provisions for isolating external Q-RPTs from the **TEST** circuit.



As a general rule, making the hydraulic connection between the PPCH TEST port and the remote Q-RPT as direct as possible favors good pressure control. As distance, volumes and restrictions between the PPCH TEST port and the remote Q-RPT increase, the possibility of difficulty with pressure control when using the external Q-RPT increases.

To connect a PPCH to an RPM4 to be used as part of the PPCH system proceed as follows:



Set up the RPM4 for use as a PPCH external device following the instructions in the RRPM4 Operation and Maintenance Manual, Using RPM4 With a PPC3 Controller/Calibrator Section.

- 1 Using tubing of appropriate pressure rating and a tee fitting, connect the RPM4 Q-RPT **TEST(+)** port to the PPCH **TEST** port (see Figure 6 for instructions on making this connection using the standard interconnection accessories supplied with the PPCH). The third leg of the tee is for the connection to the device or system under test.



When external Q-RPTs are used with PPCH, the maximum set pressure is the maximum pressure of the PPCH controller/calibrator. The maximum pressure of the PPCH is determined by the PPCH controller model or the Hi Q-RPT if one is installed (see Section 1.2.1).

- 2 Using a standard pin-to-pin DB-9M to DB-9F RS232 cable, connect COM2 of the PPCH to COM1 of the RPM4 (see Section 4.2.1.3).
- 3 Turn ON the RPM4 and the PPCH.
- 4 Press **[RPT]** on the PPCH key pad. This causes PPCH to execute the Q-RPT search function (see Section 3.3.5). Following the search, Q-RPTs with whom communication is established are shown on the PPCH display, identified by their position (see Table 6).



For PPCH to identify external RPM4s, the RPM4 COM port settings must be:

Baud rate: between 1200 and 19200

Parity: Even

Data bits: 7

Stop bits: 1

If PPCH is not able to establish communications with an RPM4 and its Q-RPTs, check that the RPM4 COM1 port settings conform to the requirements above. If the COM1 port settings are correct, check that the correct communications cable is being used (standard pin-to-pin DB-9M to DB-9F RS232) and is connected to the correct communications ports.

PPCH COM2 > 1st RPM4 COM1; 1st RPM4 COM2 > 2nd RPM4 COM1

See the RPM4 Operation and Maintenance Manual for additional information on RPM4 RS232 communications and COM port settings.

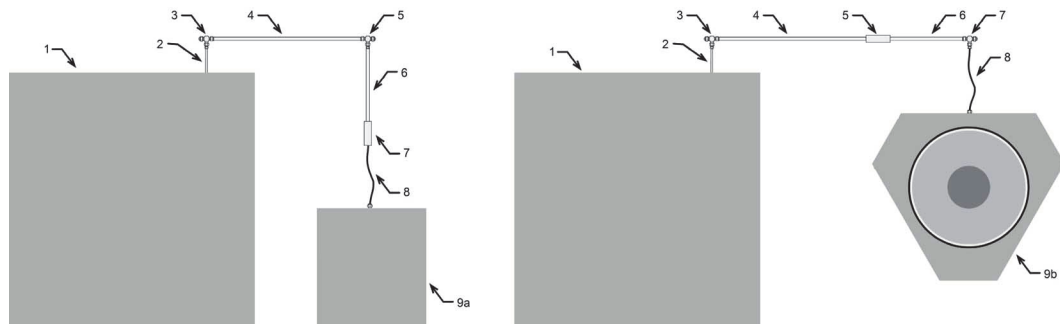

- | | |
|---------------------------------------|--|
| 1. PPCH | 7. DH500 union (RPM4) or tee (PG7000) |
| 2. 2.75 in. (70 mm) DH 500 nipple | 8. 5 in. (127 mm) DH500 x 1/8 in. tube weld nipple (slightly flexible) |
| 3. DH500 tee | 9a. RPM4 or RPM3 |
| 4. 12 in. (305 mm) DH500 nipple | 9b. PG7000 |
| 5. DH500 tee (RPM4) or union (PG7000) | |
| 6. 6 in. (152 mm) DH500 nipple | |

Figure 6. Connecting PPCH to an RPM4 or PG7302 using the standard PPCH interconnection accessories

2.3.9.3 CONNECTING TO A PG7302 PISTON GAUGE

 **ALWAYS** use external tubing and fittings rated for pressure equal to or greater than the maximum pressure PPCH will be used to generate.

PPCH is frequently used as the automated pressure generation and control component in a PG7302 oil operated piston gauge system. To do so, it must be connected hydraulically and by RS-232 to the PG7302.

The PG7302 puts the PPCH into remote mode and manages its operation.

To connect a PPCH to a PG7302 to be used as an automated pressure generation and control component in the PG7302 system, proceed as follows:

- ❶ Using tubing of appropriate pressure rating and a tee fitting, connect the PG7302 **TEST** port to the PPCH **TEST** port (see Figure 6 for instructions on making this connection using the standard interconnections accessories supplied with the PPCH). The third leg of the tee is for the connection to the device or system under test.
- ❷ Using a standard pin-to-pin DB-9M to DB-9F RS232 cable, connect COM1 of the PPCH to COM3 of the PG7302.
- ❸ See the PG7000 Operation and Maintenance Manual for information on operating the PG7302 with an automated pressure controlling device.

 For PPCH to be identified by a PG7302 platform, the PPCH-COM1 port settings must be the same as the PG7302 COM3 settings (baud rate, parity, data bits, stop bits). If the PG7000 is not able to establish communications with PPCH, check that the PPCH COM1 port settings are the same as the PG7302 COM3 settings. If the COM port settings are correct, check that the correct communications cable is being used (standard pin-to-pin DB-9M to DB-9F RS232) and is connected to the correct communications ports.

See the PG7302 Operation and Maintenance Manual for additional information on PG7302 RS232 communications and COM port settings.

2.3.9.4 CONNECTING TO A DEVICE UNDER TEST (TEST PORT)



ALWAYS use external tubing and fittings rated for pressure equal to or greater than the maximum pressure PPCH will be used to generate.

Using a pressure connecting hose or tube of appropriate pressure rating, connect the device or system to be tested to the PPCH **TEST** port. The PPCH **TEST** connection is **DH500 female**.



DH500 is a gland and collar type fitting for 1/4 in. (6.35 mm) coned and left hand threaded tube. DH500 is equivalent to AE F250C, HIP HF4, etc.



Minimizing the length of the test connection tubing will enhance control performance and reduce pressure setting time. For normal operation, the optimum total volume of the device or system under test including connecting tubing is 50 cc (3 in³) and should be less than 100 cc (6 in³).



PPCH pressure control will not operate properly if there are excessive leaks in the system connected to its TEST port. In general, the maximum acceptable leak rate for optimal PPCH automated pressure control operation and to assure in tolerance measurements with default pressure control parameters is 0.005 % of reading/second. In DYNAMIC CONTROL mode, to handle higher test system leak rates, increase the hold limit using CUSTOM CONTROL (see Section 3.4.6.1) or use HI VOLUME DYNAMIC CONTROL (see Section 3.2.2.2).



When the PPCH is vented ([VENT] LED ON), the system connected to the TEST port is connected to the reservoir. If there is an open point in the system below the fluid level in the reservoir, liquid will run out of the reservoir through the open point.

2.3.10 CHECK/SET SECURITY LEVEL

PPCH has a security system based on user levels. By default, the security system is set to "low", which includes certain access restrictions, and there is no password required to change the security level. See Section 3.5.5.5 for information on the security level system. As part of the PPCH startup, determine the security level that is appropriate for the PPCH and set a password if desired.



PPCH is delivered with the security level set to "low" to avoid inadvertent altering of critical internal settings but with access to changing security levels unrestricted. It is recommended that the low security level be maintained at all times and password protection be implemented if control over setting of security levels is desired.

2.3.11 TURN OFF ABSOLUTE MEASUREMENT MODE

PPCH Q-RPTs can operate in both absolute and gauge measurement modes (see Section 3.3.3). If the PPCH will only be used in gauge mode, absolute measurement mode may be turned off for its Q-RPT(s) so it is no longer accessible. This can avoid confusion and/or accidental use of the wrong measurement mode. See Section 5.3.5 for complete information on turning off absolute measurement mode.

2.4 POWER-UP AND VERIFICATION

2.4.1 SWITCH POWER ON

Actuate the power switch on the PPCH rear panel. Observe the front panel display as PPCH initializes, error checks and goes to the MAIN RUN screen (see Section 3.1.1).

PPCH power-up condition is Internal, Hi Q-RPT or utility sensor active, VENT ON unless the pressure measured by the Hi Q-RPT is more than 100 kPa (15 psi) away from standard atmospheric pressure.

If the PPCH fails to reach the MAIN RUN screen, service is required. Record the sequence of operations and displays observed. Contact a DHI Authorized Service Provider (see Table 31).

2.4.2 APPLY PNEUMATIC POWER (DRIVE AIR)

Apply pneumatic power of the appropriate pressure and flow rate to the PPCH **DRIVE** port (see Section 2.3.5). It is normal for the hydropneumatic pump to cycle a few times when drive air is applied.

2.4.3 CHECK PRESSURE MEASUREMENT OPERATION

2.4.3.1 CHECKING ABSOLUTE MODE PRESSURE MEASUREMENT

Check that the PPCH operates properly in **absolute** mode.

If the PPCH is not vented (VENT LED ON), press the **[VENT]** direct pressure control key (see Section 3.1.3).

Use the **[RANGE]** function key to change ranges if necessary and select the Q-RPT's DF range (see Section 3.3.1). Press the **[MODE]** function key and select **<absolute>** (see Section 3.3.3). Use **[UNIT]** to change the pressure unit if desired (see Section 3.3.2).

Observe the current value of atmospheric pressure. Check that the value agrees with the local value of atmospheric pressure. Repeat this process for all the Q-RPTs and or the utility sensor in the PPCH system. Check that the values of atmospheric pressure measured by the different devices agree with each other within PPCH or RPM4 measurement tolerances as applicable (see Section 1.2.2.1, 1.2.2.2). Remember to consider that head pressures can be significant with liquids (see Section 3.3.7). If the Q-RPTs do not agree within tolerances, the PPCH or RPM4 Q-RPT may need calibration or repair.

2.4.3.2 CHECKING GAUGE MODE PRESSURE MEASUREMENT

If the PPCH is not vented (VENT LED ON), press the **[VENT]** direct pressure control key to vent it (see Section 3.1.3).

Use the **[RANGE]** function key to change ranges if necessary and select the Q-RPT's DF range (see Section 3.3.1). Press the **[MODE]** function key and select **<gauge>** mode (see Section 3.3.3). Use **[UNIT]** to change the pressure unit if desired (see Section 3.3.2).

It is normal for PPCH to indicate a value other than zero for up to thirty seconds when first entering **gauge** mode. After ten to thirty seconds, the VENT LED should flash and zero should be indicated. If this does not occur, check that the AUTOZERO function is ON (see Section 3.5.1). If AUTOZERO is ON and the displayed pressure will not zero when vented in gauge or bi-directional gauge measurement mode, PPCH may need repair.



*If a non-zero head correction value is active, PPCH will not indicate zero when vented in gauge mode. Use **[HEAD]** to set the head height to zero (see Section 3.3.7).*

Using the **[RANGE]** function key to change ranges, observe that zero is indicated for each Q-RPT within 10 to 30 seconds.

2.4.4 PRIME AND PURGE TEST SYSTEM

For PPCH pressure control to operate properly, it is important to minimize the amount of gas present in the system connected to the **TEST** port. The prime and purge functions are intended to assist in removing gas from the test system before starting a test.

Prior to controlling pressure with PPCH, it is recommended that a priming and/or purging procedure be completed (see Section 3.3.8).

2.4.5 LEAK CHECK

PPCH cannot control pressure properly if the system connected to the **TEST** port has excessive leaks. See Section 3.3.9 or information on the PPCH leak test function.

For PPCH to operate properly, the leak rate in the test system after stabilization should not exceed 0.005% of reading/second.



Verify the maximum pressure rating of the system connected to the PPCH TEST port before entering a purge pressure value. Do not enter a purge pressure greater than the pressure rating of the system or instruments connected to the PPCH TEST port.

2.4.6 CHECK PRESSURE CONTROL OPERATION

Select a pressure range using **[RANGE]** (see Section 3.3.1).

Press **[SETUP]**, **<6control>**, **<2mode>**, **<1dynamic>**, **<1standard>** (see Section 3.4.6). If PCH was not already set to dynamic control mode, wait 5 minutes for the thermal pressure controller to stabilize.

Press **[ENT]**. Key in a target pressure within the active range and press **[ENT]** again (see Section 3.3.10).



Verify the maximum pressure rating of the system connected to the PPCH TEST port before entering a target pressure. Do not enter a target pressure greater than the pressure rating of the system or instruments connected to the PPCH TEST port.

PPCH should set the target pressure and indicate *Ready* (see Section 3.2.3) continuously in 60 to 120 seconds. If it does not, see Section 6 to troubleshoot.

2.5 STORAGE AND SHIPPING

2.5.1 SHORT TERM STORAGE

The following procedure is recommended for short term storage of PPCH:

- 1 Vent the PPCH test pressure.



If the PPCH TEST port is open to a point lower than the reservoir, when PPCH is vented ([VENT] LED ON), the liquid contained in the reservoir may leak out through the opening.

- 2 Turn the power OFF using the rear panel power switch.
- 3 Shut OFF or disconnect the drive air pressure supply.

2.5.2 LONG TERM STORAGE

The following procedure is recommended for long term storage of PPCH:

- 1 Complete the short term storage procedure (see Section 2.5.1).
- 2 Plug the **TEST** port with a DH500 steel plug.
- 3 Set the **RESERVOIR FILL/DRAIN** valve to **CLOSED** and the **RESERVOIR RETURN** valve to **INTERNAL**.

2.5.3 PREPARATION FOR SHIPPING

The following procedure is recommended to prepare PPCH for shipment:

- 1 Complete the long term storage procedure (see Section 2.5.2).
- 2 Remove the internal reservoir accessories if they have been installed (see Section 2.3.6.1).
- 3 Pack PPCH carefully being sure to use packing materials appropriate for shipment of a delicate instrument weighing approximately 50 kg (110 lb.). If available, use the original packing materials.

3. OPERATION

3.1 USER INTERFACE

PPCH is designed to offer a practical balance between simple, straight forward operation and the availability of a wide variety of advanced functions with a high level of operator discretion. The local operator interface is through a 2 x 20 display, a function/data keypad, a cursor control pad and direct pressure control keys.

Remote communication is by RS232 (COM1) or IEEE-488. See Section 4 for information on remote communication.

3.1.1 MAIN RUN SCREEN

The PPCH MAIN RUN screen is its home display that is reached on power-up and from which other functions and menus are accessed. It is the very top level of all menu structures.

The MAIN RUN screen is where the operator works with PPCH to set and read pressures. It provides complete information on the system's current configuration and operating status.

Table 5 summarizes the PPCH MAIN RUN screen fields and their functions.



PPCH has a screen saver function which causes the display to dim if no key is pressed for 10 minutes. Pressing a key restores full power to the display. The screen saver time can be changed or screen saving can be completely suppressed (see Section 3.5.5.1).

Table 5. MAIN RUN screen display fields

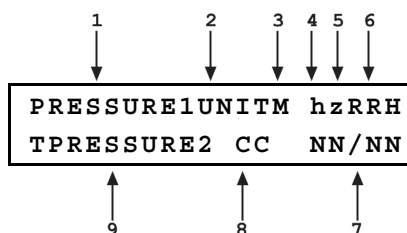

DISPLAY FIELD	NAME	PURPOSE	CONTENTS	SECTION
1. PRESSURE1	Measured pressure	Displays pressure measured by active Q-RPT or utility sensor	Numerical pressure value and sign	1.2.2.1 1.2.2.2 3.3.10
2. UNIT	Unit of measure	Identifies unit of measure in which PRESSURE1 and PRESSURE2 are displayed	Pressure unit of measure abbreviation	3.3.2
3. M	Measurement mode	Identifies measurement mode of displayed pressure	<a>: absolute <g>: gauge	3.3.3
4. h	Head pressure indicator	Indicates whether a fluid head correction is applied to PRESSURE1	<h>: the fluid head is not zero <blank>: fluid head is zero	3.3.7
5. z	AutoZero indicator	Indicates whether the AutoZero function is ON or OFF	<z>: AutoZ is ON <blank>: AutoZ is OFF	3.5.1
6. RRH	Active Q-RPT position indicator	Indicates the position in the PPCH system of the active Q-RPT or utility sensor	<IH>: Internal Hi <luH>: Internal Hi (utility sensor) <IL>: Internal Lo <X1H>: External 1 Hi <X1L>: External 1 Lo <X2H>: External 2 Hi <X2L>: External 2 Lo	3.2.5
7. NN/NN	Sequence progress indicator	Indicates progress of an ATest sequence, during test execution	<NN/NN>: Number of this point over total number of points in the sequence	3.3.6
8. CC	Pressure control indicator	Indicates type of pressure control, whether control is currently active and whether custom control limits are in use	<D>: Control mode is standard dynamic <d>: Control mode is hi volume dynamic <S>: Control mode is static <M>: Control mode is monotonic <R>: Control mode is rate <C> is appended to the control character if control limits are custom Control character(s) flash when PPCH is actively controlling	3.2.1 3.4.6

DISPLAY FIELD	NAME	PURPOSE	CONTENTS	SECTION
9. TPRESSURE2	Pressure information indicator	Pressure indication depending on current PPCH function. Leading character identifies the value.	<p><R>: Pressure rate of change in current pressure unit/second</p> <p><T>: Pressure control target</p> <p><D>: Deviation from the pressure control target</p> <p><Reservoir level low>: Indicates that the reservoir needs to be filled urgently.</p>	3.3.10 3.5.7.3.2

3.1.2 FUNCTION / DATA KEYPAD LAYOUT AND PROTOCOL

The PPCH has a function/data keypad for local operator access to direct functions, function menus and for data entry.

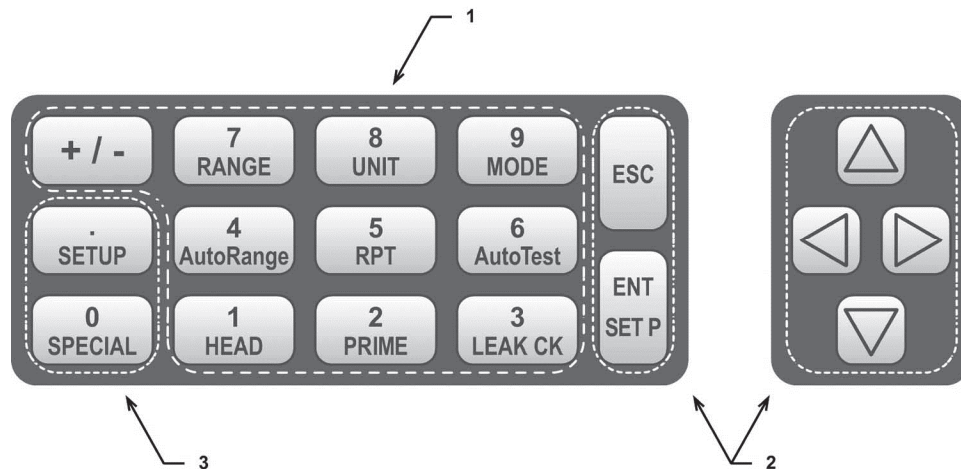

1. The **Function/Data keys** allow very commonly used functions to be accessed directly by a single keystroke when pressed from the MAIN RUN screen (see Section 3.1.1). The name of the function is on the bottom half of the key. These keys enter numerical values when editing.
2. The **Editing and Execution keys** are for starting and suspending command execution, cursor control in menus and editing entries.
3. The **Menu/Data keys** provide access to function menus when pressed from the MAIN RUN screen. The menu name is on the bottom half of the key. The SETUP menu is for more frequently used functions (see Section 3.4). The SPECIAL menu is for functions that are not generally used as a part of day to day operation (see Section 3.5). These keys enter numerical values when editing.

Figure 7. Keypad layout

Pressing the **[ENT/SET P]** key generally causes execution or forward movement in the menu tree. Pressing **[ENT/SET P]** from the MAIN RUN screen allows an automated pressure control command to be given.

Pressing the **[ESC]** key moves back in the menu tree and/or causes execution to cease or suspend. Pressing **[ESC]** repeatedly eventually returns to the MAIN RUN screen and, from there, allows momentary viewing of the PPCH introduction screen.

Pressing the **[+/-]** key changes a numerical sign when editing. It also toggles through multiple screens when available and is a shortcut to a momentary display of the active RANGE from the MAIN RUN screen.

Pressing the **[△]**, **[▽]**, **[◀]** and **[▶]** keys allows reverse, forward and up, down cursor movement when editing data entry or moving in menus.



Some screens go beyond the two lines provided by the display. This is indicated by a flashing down arrow in the second line of the display. Press the cursor control keys to move the cursor to access the lines that are not visible or directly enter the number of the hidden menu choice if you know it.

3.1.3 DIRECT PRESSURE CONTROL KEYS



Figure 8. Direct pressure control keys

The direct pressure control keys provide direct manual control of pressure increase, decrease, jog and vent. They can be useful in adjusting pressure when automated pressure control to a target pressure or rate is not needed. The jog keys are also used to adjust the target pressure during active dynamic pressure control.

Pressing the **[VENT]** key aborts automated pressure control if active and causes PPCH to control pressure to near atmospheric pressure and then open the system vent valve (see Figure 9). On-going execution of the vent function is indicated by lighting a RED LED just above the **[VENT]** key. Completion of the vent process is indicated by the *Ready/Not Ready* indicator light becoming GREEN with the vent RED vent LED still lighted. The vent valve remains open until the **[VENT]** key is pressed again, another direct pressure control key is pressed, or an automated pressure control command is given. Removing electrical power also closes the vent valve.

Pressing the **[▲]** and **[▼]** direct pressure control keys aborts automated pressure control if active and causes pressure to increase or decrease at the slow slew rate. Holding the **[FAST]** key pressed while pressing the **[▲]** or **[▼]** key causes the pressure increase or decrease speed to change from slow to fast.

Pressing the **[▲]** and **[▼]** direct pressure control keys has a different effect depending on the PPCH's current activity:

- **Pressure control idle:** Causes the pressure to jog or step by a fixed amount which is set automatically depending on the range (see Section 3.4.6, Table 10). The amount can be adjusted using **[SETUP]**, **<3jog>** or by pressing both the up and down jog keys simultaneously (see Section 3.4.3).
- **Dynamic pressure control active:** Causes the target pressure to be changed by a fixed amount which is set automatically depending on the range. One press causes one step. The step value can be adjusted using **[SETUP]**, **<3jog>** or by pressing both the up and down jog keys simultaneously (see Section 3.4.3).
- **Static pressure control active:** No effect while pressure is actively controlled, changes pressure by jog amount when pressure is in hold limit waiting for stability.
- **Monotonic pressure control active:** No effect.
- **Ramp control active:** No effect.



Pressing the up and down pressure jog keys (**[▲]** and **[▼]**) simultaneously is a shortcut to the jog step size adjustment menu.

3.1.4 REMOTE [ENT/SET P] (FOOT)SWITCH

The optional remote ENTER function is a switch that duplicates the function of the front panel [ENT] key. The remote ENTER function is serviced by a connector on the PPCH rear panel labeled **REMOTE ENTER**. An optional footswitch is available to activate remote entry hands free or a user supplied switch may be used. See Section 7.3 for information on remote ENTER switch wiring.

The remote ENTER feature can be particularly convenient when running AutoTests (see Section 3.3.6) in which using a footswitch to [ENT] allows hands free operation.

3.1.5 SOUNDS

PPCH is equipped with a variable frequency tone device to provide audible feedback and alarms. The beeper is used for the following indications.

Valid key press	Brief beep. Choice between three frequencies or NO sound is available (see Section 3.5.5.2).
Invalid key press	Descending two tone “blurp”.
Leak check completed	Three two second beeps (see Section 3.3.9).
Purge routine completed	Three two second beeps (see Section 3.3.8.2).
Upper limit exceeded	Intermittent one second beeps (see Section 3.4.4)
Active external device not connected	Eight second high frequency beep (see Section 3.2.5)
Pmax! (overpressure limit) exceeded	Eight second high frequency beep (see Section 3.4.4.1).
AutoTest reading in tolerance/out of tolerance reading	Ascending triad/descending triad (see Section 3.3.6).
Reservoir level low	Ten brief beeps (see Section 3.5.7.3.2).

3.2 GENERAL OPERATING PRINCIPLES

3.2.1 PRESSURE CONTROL PRINCIPLES

Numerical references in this section refer to Figure 9.

PPCH is designed to precisely generate, measure and control liquid pressure into a volume connected to its **TEST** port (13). Pressure is measured by a utility sensor or one or two Quartz Reference Pressure Transducers (Q-RPT)(15, 18).

Pressure is generated internally using a hydropneumatic pump(19). The hydropneumatic pump uses the ratio of two pistons to transform low pressure drive air into high pressure liquid output. The drive air pressure is controlled by an internal pressure regulator(3).

The liquid supply to the pump is from an internal or external reservoir. Liquid returned from the test system when reducing pressure is returned to the internal or external reservoir via a return tube that provides a constant fluid level when the system is vented. Provision is made for filling, draining, returning liquid to and viewing the level of the internal or external reservoir (6, 7,8,9,10) (see Section 5.6). Should the system be run with the reservoir empty causing the pump to draw air and lose its prime, the internal reservoir can be pressurized to reprime the pump(4, 5) (see Section 5.10.1).

The hydropneumatic pump high pressure output supplies a servo-controlled inlet valve(17). The inlet valve is a pressure balanced needle valve whose needle position is controller by a stepper motor and belt drive. The inlet valve provides very high precision control of the liquid

admitted to the test system from the hydropneumatic pump to the test system. An outlet valve(11) of the same type as the inlet valve precisely controls liquid exhaust.

The inlet and exhaust valve can adjust and maintain pressure rates of change very precisely.

When conditions are appropriate, a second stage of pressure control is used to maintain a target pressure value within very narrow hold limits in dynamic control mode. The second stage is thermal pressure control (TPC). TPC, uses a pressurized volume in which there is a heating element and around which there is a forced air cooling system(14). Heating and cooling the fluid in the volume causes it to expand or contract, increasing or decreasing pressure. This pressure control system allows extremely fine pressure control without hysteresis or wear of mechanical parts.

The TPC system response is dependent on the operating liquid and the volume connected to the **TEST** port. It is minimally effective when there are leaks in the test system or the test volume is large. PPCH automatically determines whether conditions are appropriate to use TPC and runs an automated routine to determine the test volume. This routine is initiated automatically when needed.

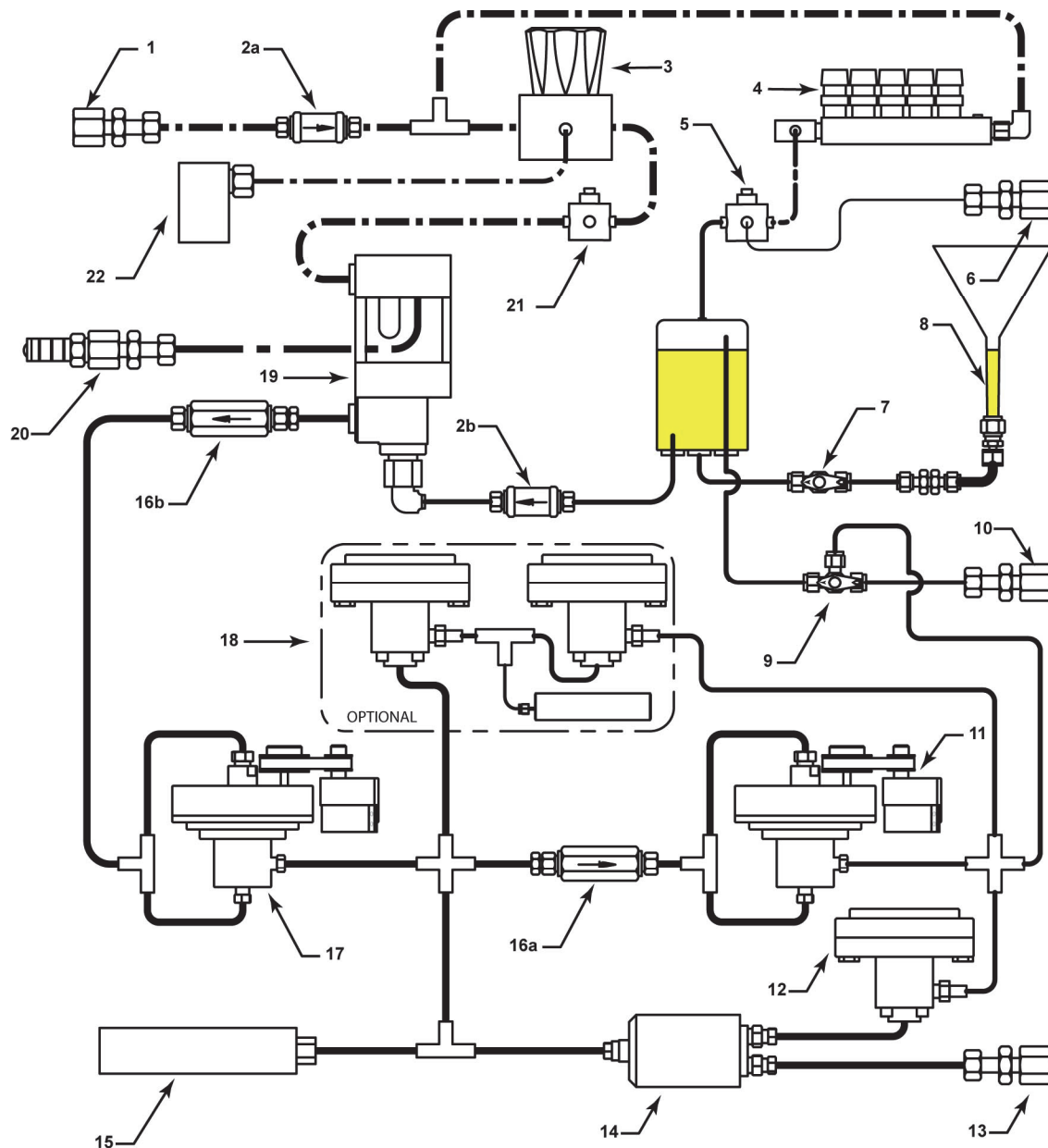

- | | |
|---------------------------------------|---|
| 1. DRIVE air port | 12. Vent valve, pneumatically controlled |
| 2a. Drive air supply filter | 13. TEST port |
| 2b. Pump inlet filter (liquid) | 14. Thermal pressure control unit (TPCU) |
| 3. Drive air regulator | 15. Hi Q-RPT |
| 4. Drive air control manifold | 16. High pressure filter(s) |
| 5. Three-way reservoir pressure valve | 17. Inlet valve, servo-controlled |
| 6. OVERFLOW port | 18. Lo Q-RPT, shutoff valve, vent valve, pneumatically controlled |
| 7. Reservoir fill/drain valve | 19. Hydropneumatic pump |
| 8. Reservoir fill/drain/level tube | 20. Pump drive out vent port and filter/muffler |
| 9. Reservoir return valve | 21. Two-way hydropneumatic pump cutoff valve |
| 10. EXTERNAL return port | 22. Pump drive air pressure transducer |
| 11. Outlet valve, servo-controlled | |

Figure 9. Pressure control system schematic

3.2.2 AUTOMATED PRESSURE CONTROL

PPCH automated pressure control provides automated generation and control of pressure to a user designated target value or ramp rate.



See Section 3.3.10 for information on using [ENT/SET P] to set pressure automatically and abort automated pressure control.

PPCH supports four pressure control modes to meet different pressure setting and controlling requirements: dynamic, static, monotonic and ramp. Pressure control parameters for each control mode are automatically set to optimal default values for the operating PPCH range when the range is selected or AutoRange is used (see Section 3.3.4). Control parameters can be customized using the [SETUP], <6control> function (see Section 3.4.6.1).

Control parameters:

Target Value	The pressure set point or ramp rate specified by the operator (dynamic, static, monotonic, ramp modes).
Target Limit	Setting short of the target value (monotonic mode).
Hold Limit	A symmetrical positive and negative control limit around a target value within which the controlled pressure or rate is maintained (dynamic, static, ramp modes).
Rate Limit	A rate of change of pressure limit in the same sign as the direction in which pressure is controlled in units of pressure/second (monotonic mode).
Stability Limit	An absolute value rate of change of pressure limit in units of pressure/second (static mode and control not active).



See this Section 3.2.2 and Sections 3.2.2.1 to 3.2.2.5 for a detailed explanation of each control mode and its advantages, the default control parameters and the control customization options.

3.2.2.1 IDLE, NO AUTOMATED CONTROL (MEASURE MODE)

In any control mode, PPCH pressure control can be interrupted so that no control occurs. Control inactive is indicated by the pressure control indicator characters on the MAIN RUN screen NOT flashing. The control character(s) is/are the two characters in the center of the bottom line of the display (see Section 3.1.1).

To abort control when control is active press [ENT/Set P], [ESC], [VENT], [△] or [▽]. [ENT/Set P] does NOT abort control in monotonic mode.

When control is idle (measure mode), a *Ready* condition occurs any time the pressure stability test is met (see Section 3.2.3).

3.2.2.2 DYNAMIC CONTROL

Dynamic control mode is designed to set the pressure to the target value and control continuously to keep pressure within the hold limit and as close to the target value as possible (see Figure 10).

The advantage of this control mode is that the final pressure achieved is the same as the target value. The maximum value of the control error is equal to the hold limit. The average value of the control error is generally much smaller than the hold limit.

During dynamic pressure control, the hold limit is active. If the pressure goes outside of the hold limit, a *Not Ready* condition occurs. See Table 10 for default hold limit values and Section 3.4.6 to customize the hold limit.

There are two types of dynamic control. *Standard* dynamic control is the default type of dynamic control used in most situations. *Hi volume* dynamic control is also available for situations in which standard dynamic control cannot achieve a *Ready* condition in a reasonable amount of time and/or cannot maintain the *Ready* condition once achieved. *Hi volume* dynamic control may be necessary when the test volume connected to the PPCH is greater than 100 cc. The difference between *standard* and *hi volume* dynamic pressure control is in the use of the thermal pressure controller (TPCU). In *standard* dynamic control, control transitions from the control valves to the TPCU before *Ready* occurs and the target pressure is reached. In *hi volume* dynamic control, control is by the valves only unless they valves are unable to maintain the *Ready* condition.

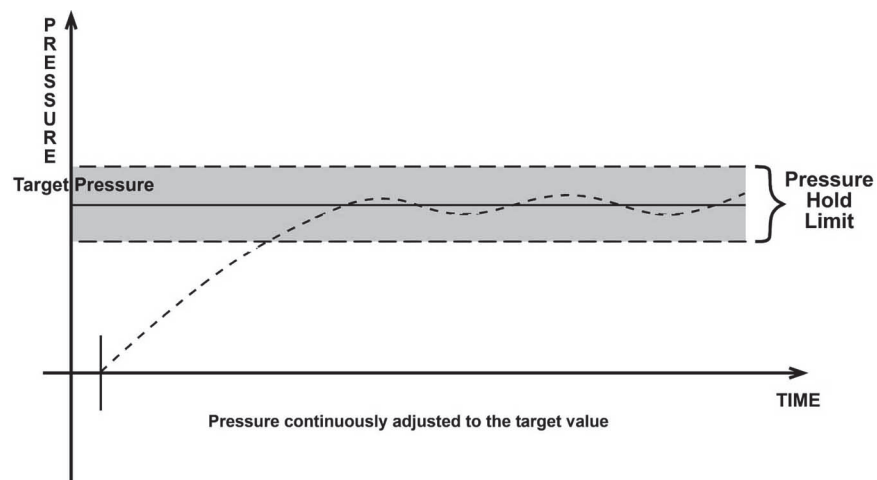

Figure 10. Dynamic pressure control operation

PPCH includes a *Ready/Not Ready* feature that indicates when current pressure control requirements have been met (see Section 3.2.3).

With dynamic pressure control active, a *Ready* condition occurs whenever:

- The current measured pressure is inside the hold limit.

Figure 11 illustrates *Ready/Not Ready* operation in dynamic control mode.



In dynamic control mode, normal procedure is to assume that when a *Ready* condition occurs (pressure inside the control hold limit), the measured pressure equals the target pressure. For this reason, when the pressure is *Ready* in dynamic control mode, the measured pressure display is equal to the target pressure.

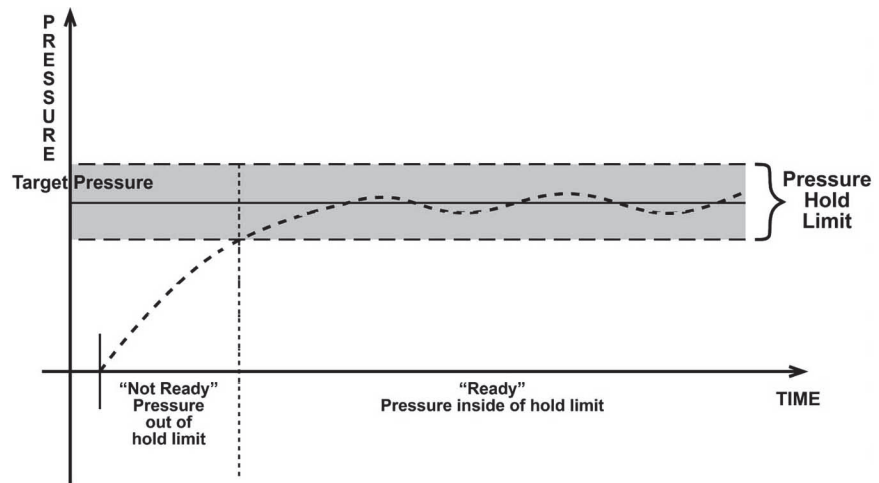

Figure 11. Ready/Not Ready in dynamic pressure control mode

3.2.2.3 STATIC CONTROL

Static control mode is designed to set the pressure near the target value and then interrupt active control to allow pressure to stabilize naturally within the hold limit (Figure 12).

The advantage of this control mode is that pressure can be set and/or measured within a defined limit of a target without interference from the pressure control system. In a system without excessive leaks, the pressure stability achieved may be greater than the stability with which the pressure control system can actively control pressure. Using static control to control pressure near the desired set point and then measuring back the stabilized pressure without interference of the control function can allow control errors to be completely eliminated. However, the final pressure achieved is not equal to the target value and the time required to achieve sufficiently stable pressure is dependent on the characteristics of the test volume and may be longer than in other modes.

During static pressure control, the hold limit is active. If the pressure goes outside of the hold limit, pressure is readjusted to the target value. See Table 10 for default hold limit values and Section 3.4.6 to customize the hold limit.

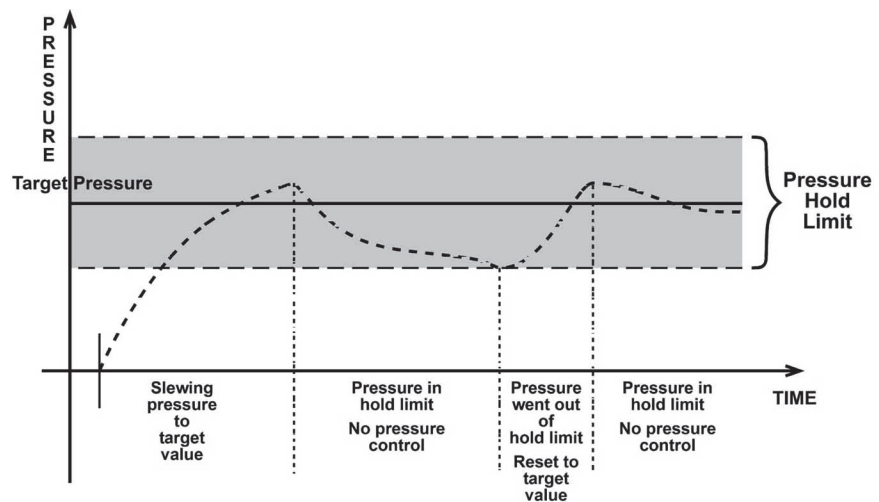

Figure 12. Static pressure control operation

PPCH includes a *Ready/Not Ready* feature that indicates when current pressure control requirements have been met (see Section 3.2.3).

With static pressure control active a *Ready* condition occurs whenever:

- NO control valve is operating.
- The current measured pressure is at the target value within the hold limit.
- The rate of change of pressure is less than the current stability limit.

Figure 13 illustrates *Ready/Not Ready* operation in Static control mode.

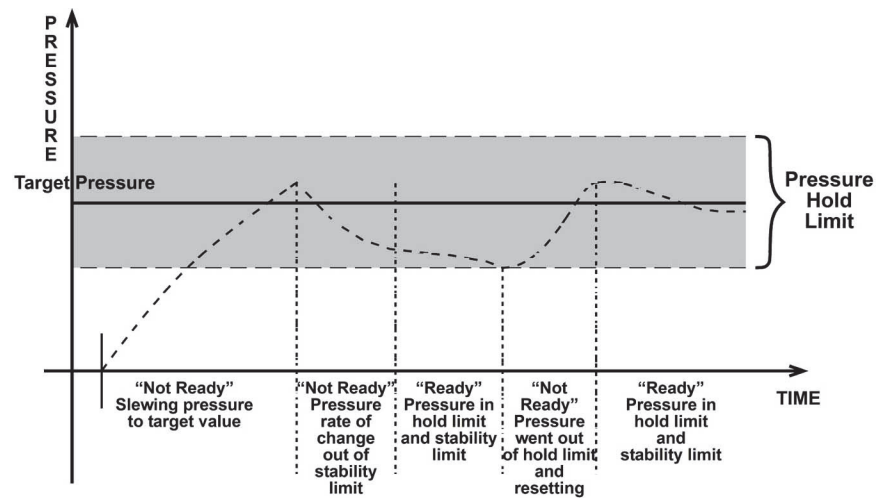

Figure 13. *Ready/Not Ready* in static control mode

3.2.2.4 MONOTONIC CONTROL

Monotonic control mode is designed to set pressure increments and take data from a device under test while assuring the evolution of pressure is always in the same direction (ascending for ascending increments, descending for descending increments). In monotonic control mode the pressure is set near the target value and then controlled at a low rate of change in the same direction as the target pressure approach (see Figure 14). Measured pressure data is taken from the PPCH and output from the device under test during the slow ramp near the target pressure.

The advantage of this control mode is that in a sequence of pressures, ascending or descending increments are set without overshoot or oscillation as is desirable when determining the hysteresis of a device under test (DUT). This method also tends to achieve a ready condition more quickly than dynamic or static control. However, the final pressure achieved is not equal to the target value and for best results it is necessary to average alternating PPCH and DUT readings to compensate for possible timing differences in the readings.

When setting a monotonic pressure point, PPCH attempts to set a ramp rate less than the rate limit at the near end of the pressure target limit and then maintains the ramp rate until a new pressure target value is entered or the range “upper limit” (UL) is reached (see Section 3.4.4). If the ramp rate exceeds the specified target rate or changes sign, a *Not Ready* condition occurs. See Table 10 for default pressure and ramp rate target limit values and Section 3.4.6 to customize the limits.

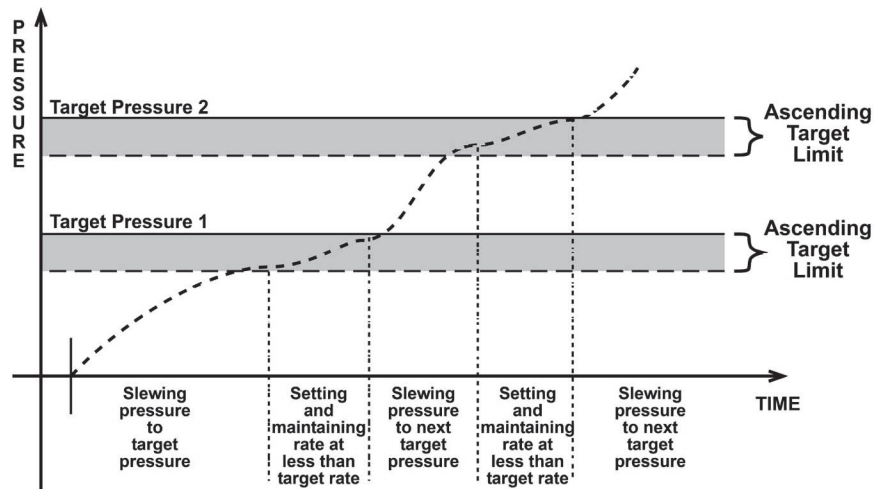

Figure 14. Monotonic pressure control operation

PPCH includes a *Ready/Not Ready* feature that indicates when current pressure control requirements have been met (see Section 3.2.3).

With monotonic pressure control active, a *Ready* condition occurs whenever:

- PPCH has reached the target pressure has passed the target limit and is controlling ramp rate at less than the rate limit.

Figure 15 illustrates *Ready/Not Ready* operation in monotonic control mode.

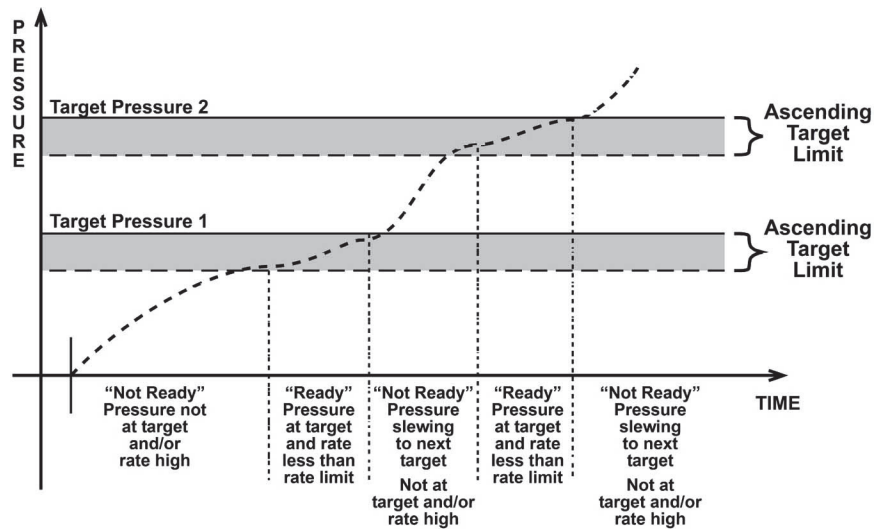

Figure 15. *Ready/Not Ready* in monotonic pressure control mode

3.2.2.5 RAMP CONTROL

Ramp control is designed to set a pressure ramp at a target rate and maintain the rate within a rate hold limit (see Figure 16). This control mode can be used for a variety of calibration and testing functions.

When setting a ramp, PPCH attempts to establish the target rate within the rate hold limit as quickly as possible and then maintains the rate until a new command is given or the active range “upper limit” is reached (see Section 3.4.4). If the rate is outside of the rate hold limit, a *Not Ready* condition occurs. See Table 10 for default target rate and hold limit values and Section 3.4.6 to customize the hold limit.

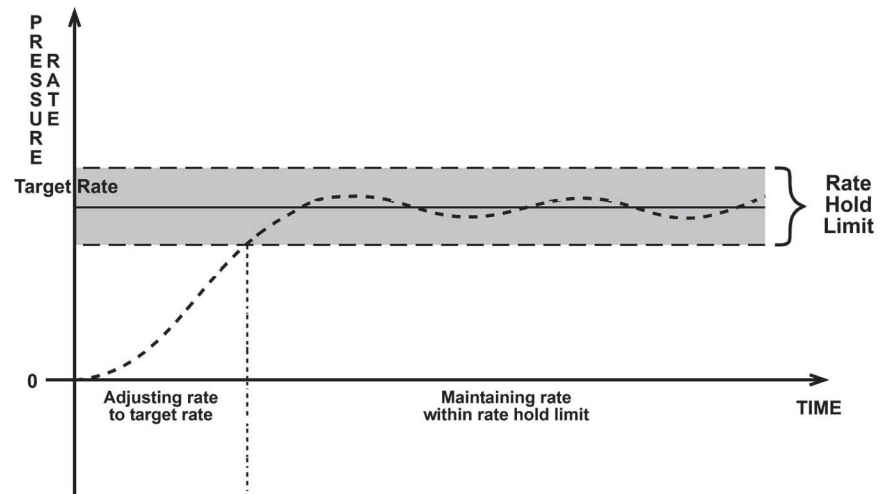

Figure 16. Ramp pressure control operation

*Note that Figure 15 plots rate of change of pressure, not pressure.

PPCH includes a *Ready/Not Ready* feature that indicates when current pressure control requirements have been met (see Section 3.2.3).

With ramp pressure control active, a **Ready** condition occurs whenever:

- PPCH is controlling rate at the target rate value within the rate hold limit.

Figure 17 illustrates *Ready/Not Ready* operation in ramp control mode.

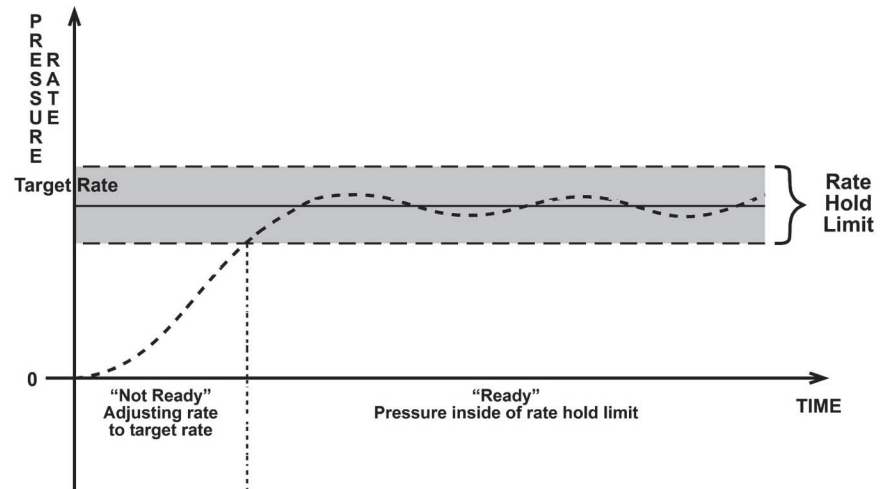

Figure 17. *Ready/Not Ready* in ramp pressure control mode

*Note that Figure 16 plots rate of change of pressure, not pressure.

3.2.3 PRESSURE READY/NOT READY

There is a *Ready/Not Ready* indication LED on the PPCH front panel. *Ready/Not Ready* status is also available remotely. This indication is intended to provide the operator with a clear and objective criterion for determining when a valid pressure measurement can be made.

The *Ready/Not Ready* LED indications are:

- <Green, no flash> Pressure **Ready**, control idle. PPCH is NOT actively controlling the pressure. This indicates no control is occurring and the pressure stability is within the stability limit.
- <Green, slow flash> Pressure **Ready**, control active. PPCH is actively controlling the pressure and the criteria for a **Ready** condition to occur in the active control mode have been met.
- <Red > Pressure **Not Ready**. Either PPCH is idle and pressure does not meet the stability limit or PPCH is actively controlling the pressure and **Ready** conditions have not yet been met. The control characters in the middle of the second line of the MAIN RUN screen flash if control is active (see Section 3.1.1).

When automated pressure control is idle (measure mode): A **Ready** condition occurs any time the pressure rate of change is inside the stability limit. The stability limit is defined in terms of rate of change of pressure in current pressure units per second. The stability limit is set by default (see Table 10) and can be customized (see Section 3.4.6).

When pressure control is active: The criteria for determining the *Ready/Not Ready* condition depend on whether the current control mode is static, dynamic, monotonic or ramp (see Sections 3.2.2.2, 3.2.2.3, 3.2.2.4, 3.2.2.5). Pressure **Ready/Not Ready** parameters are set by default when AutoRange is used, or a control mode is selected (see Table 10). The parameters can be customized if desired (see Section 3.4.6).

3.2.4 GAUGE MEASUREMENT MODE, DYNAMIC COMPENSATION FOR ATMOSPHERIC PRESSURE

PPCH utility sensors and Q-RPTs are intrinsically absolute but they are also used in gauge measurement mode (difference from atmosphere) (see Section 3.3.3, ○ PRINCIPLE). Gauge measurement mode is achieved by subtracting the value of atmospheric pressure, $P_{\text{offset,G}}$, from the Q-RPT's absolute reading using AutoZ (see Section 3.5.1). In gauge measurement mode, the AutoZ routine that measures $P_{\text{offset,G}}$, is run automatically whenever the PPCH is in the vented condition. This assures the continuous automated updating of the $P_{\text{offset,G}}$ value corresponding to atmospheric pressure. Gauge pressure is the measured absolute pressure, P_u , minus the atmospheric offset.

$$P_{\text{gauge}} = P_u - P_{\text{offset,G}}$$

However, atmospheric pressure can change between opportunities to run AutoZ and update the value of $P_{\text{offset,G}}$, for example when running an extended test without venting. PPCH uses **dynamic compensation for atmospheric pressure** to correct for these changes in atmospheric pressure. When AutoZ executes, and $P_{\text{offset,G}}$ is determined, the reading of PPCH's on board barometer, $P_{\text{atm,0}}$, is also recorded. Later, when no longer vented, the change in atmospheric pressure, ΔP_{atm} , since $P_{\text{offset,G}}$ was updated, is the difference between the current barometer reading, P_{atm} , and the barometer reading at the time of AutoZ execution, $P_{\text{atm,0}}$:

$$\Delta P_{\text{atm}} = P_{\text{atm}} - P_{\text{atm,0}}$$

Dynamic compensation for atmospheric pressure uses ΔP_{atm} to correct the value of $P_{\text{offset,G}}$, thus always compensating real time for changes in atmospheric pressure:

$$P_{\text{gauge}} = P_u - P_{\text{offset,G}} - \Delta P_{\text{atm}}$$

PPCH Q-RPTs allow instantaneous switching between gauge and absolute measurements modes. Any additional uncertainty in gauge measurement mode due to the dynamic compensation for atmospheric pressure technique is a function of the resolution and short term stability of the on-board barometer, not its absolute measurement uncertainty. This additional uncertainty, ± 1 Pa (0.00015 psi), is insignificant in the pressure ranges covered by PPCH.

3.2.5 MULTIPLE INTERNAL AND EXTERNAL Q-RPTS

A base PPCH pressure controller includes a high precision, utility pressure sensor whose range is equal to the controller's range. The utility sensor is not intended to serve as a pressure reference for low uncertainty measurement. It is for indication, pressure control, system safety and maintenance functions only.

To obtain low uncertainty, traceable pressure measurement, PPCH uses Quartz Reference Pressure Transducers (Q-RPT). Up to six Q-RPTs can be included in a PPCH pressure controller/calibrator system. One or two Q-RPTs can be built into the PPCH, up to two may be located outside the PPCH enclosure in RPM4 reference pressure monitors (one or two per RPM4). Once the Q-RPTs available to a PPCH system have been set up and identified, communication with them is managed by PPCH transparently to the operator. However, setting up hardware and following procedures to protect lower pressure Q-RPTs from overpressure when higher pressure Q-RPTs are used is the responsibility of the user.

 *Take precautions not to overpressure external Q-RPTs when using them with a PPCH. When using external Q-RPTs in RPM4s as reference pressure measurement devices with a PPCH, the user is responsible to setting up hardware and following procedures to protect lower range Q-RPTs from overpressure. Only the Lo Q-RPT (IL) built-into the PPCH is protected automatically.*

Communication between RPM4s and a PPCH controller is by daisy chained RS232 connections from PPCH's COM2 port.

The PPCH RPT function (see Section 3.3.5) is used to identify Q-RPTs available to the PPCH. The PPCH then manages communication with the internal and external Q-RPTs transparently to the operator, selecting the appropriate Q-RPT for the range of operation and configuring it as specified.

Each Q-RPT has a default range, which is its maximum range. It can also be downranged using PPCH's AutoRange function.

 *Before operating PPCH with an external Q-RPT, check carefully that the RPM4's Q-RPT TEST(+) port is connected to the PPCH TEST port. If an external Q-RPT is NOT connected to the PPCH TEST port, it will NOT measure the pressure generated by PPCH and PPCH may reach a pressure higher than the target pressure before its watchdog function recognizes that the external Q-RPT is not connected (see Section 3.4.4.1). The PPCH watchdog function monitors differences in the change in pressure indicated by an active, external Q-RPT and the PPCH Hi utility sensor or Q-RPT (watchdog). If the difference becomes excessive, control is aborted, an audible warning sounds and a warning is displayed.*

If this occurs, make sure the PPCH and RPM4 Q-RPT TEST(+) ports are connected together and try again.

Position Identification of Q-RPTs In a PPCH System

Position identification of the currently active Q-RPT or utility sensor in the PPCH system is continuously displayed in the upper right hand corner of the PPCH's MAIN RUN screen and most other screens (see Section 3.1.1). See Table 6 for position designation protocol for the Q-RPTs available in a PPCH system.

See Table 1 for a complete listing of Q-RPTs available and their default ranges.

Table 6. Position designators of Q-RPTs in a PPCH system

Q-RPT POSITION	IDENTIFICATION	DISPLAY SYMBOL*
Internal to PPCH, utility sensor, if present	Internal Utility, Hi	IuH
Internal to PPCH, Q-RPT of maximum range	Internal, Hi	IH
Internal to PPCH, Q-RPT with lower maximum range in PPCH with two Q-RPTs or a utility sensor and Q-RPT.	Internal, Lo	IL
External to PPCH, Q-RPT of higher maximum range in 1 st RPM4 on PPCH/RPM4 communications daisy chain	External 1, Hi	X1H
External to PPCH, Q-RPT with lower maximum range in dual Q-RPT RPM4 that is the 1 st RPM4 on the PPCH/RPM4 communications daisy chain	External 1, Lo	X1L
External to PPCH, Q-RPT of higher maximum range in 2 nd RPM4 on PPCH/RPM4 communications daisy chain	External 2, Hi	X2H
External to PPCH, Q-RPT with lower maximum range in dual Q-RPT RPM4 that is the 2 nd RPM4 on the PC3/RPM4 communications daisy chain	External 2, Lo	X2L

* The display symbol is included in the upper, right hand corner of most PPCH displays and menus as a convenient indicator of the active Q-RPT.

3.2.6 MULTIPLE RANGES (Q-RPTS, AUTORANGE AND INFINITE RANGING)

A PPCH range is defined as a pressure span and associated settings.

A PPCH may have multiple ranges. Each Q-RPT (and the utility sensor, if present) available to the PPCH system has a default range which is its maximum span. Additional ranges, lower than the Q-RPT's maximum span, may be created using AutoRange (see Section 3.3.4). Ranges created using AutoRange may be saved with all their settings for reactivation later (see Section 3.4.1).

A PPCH range is identified by a range screen showing the Q-RPT used by the range, its current unit of measure and its full scale pressure in gauge and absolute (if available) measurement modes. The range screen is viewed by pressing [RANGE] or [+/-] from the MAIN RUN screen.

1. Q-RPT or utility sensor designator.
2. Type of range. <DF> for the Q-RPT's default range; <AR> for a range created by AutoRange.
3. Q-RPT or utility sensor position designator.
4. Current pressure unit of measure.
5. Full scale pressure in current unit of measure in gauge and/or absolute measurement mode depending on the measurement modes available.

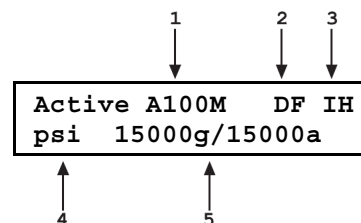

Most settings made in a PPCH range, such as unit of measure, measurement mode, display resolution, control mode and control parameters are specific to the range. The range specific settings are stored with the range and recalled whenever the range is made active. This makes setting up and saving ranges a convenient way to store and recall frequently used operating configurations. See Table 7 for a listing of PPCH adjustments and settings and whether they are range, Q-RPT or system specific.

The ranges available on a PPCH system are accessed using **[RANGE]** (see Section 3.3.1) and/or created using **[AutoRange]** (see Section 3.3.4). External Q-RPTs connected to the PPCH (see Section 3.2.5) are initialized using **[RPT]** (see Section 3.3.5).

Table 7. Settings and to what they are specific (range, measurement mode, Q-RPT, system)

SETTING	PURPOSE	SPECIFIC TO	SECTION
Unit	Set pressure unit of measure	Range	3.3.2
Mode	Set pressure measurement mode (absolute, gauge)	Range	3.3.3
Resolution	Set pressure display resolution	Range	3.4.2
Jog	Set jog step size	Range	3.4.3
Control	Set pressure control mode and parameters	Range	3.4.6
Upper Limit	Set upper limit alarm	Range and measurement mode	3.4.4
AutoZ	Run AutoZ, ON/OFF, set and view value	Range and measurement mode	3.5.1
Screen Saver, Sound, Time, ID, Level	Set system user preferences	System	3.5.5
Head	Set fluid head correction height, fluid, unit of measure	System	3.3.7 3.5.3
Valve Drivers	Set status of external valve drivers	System	3.4.7
Cal	Various Q-RPT and utility sensor calibration functions	Q-RPT, utility sensor or barometer	3.5.8

3.2.7 FLUID RESERVOIR LOW LEVEL WARNING

If PPCH's fluid reservoir is allowed to become empty, air may be drawn into the hydropneumatic pump (see Figure 9) causing it to lose its prime. If this occurs, operation is interrupted until the pump is reprimed using an on-board pump priming routine (see Section 5.10.1).

To prevent against allowing the reservoir to become empty, PPCH's internal reservoir is equipped with a float switch to provide a warning when the level is low. The warning system is active when using the internal reservoir or the external reservoir if it is connected as recommended in Section 2.3.6.2.

A low fluid level condition is indicated by:

- Ten rapid beeps when the low level is first observed during operation or on power up.
- Intermittent display of **<Reservoir level low>** on the bottom left of the MAIN RUN screen.

By default, when a low level condition is determined, PPCH pressure generation capability is stopped. This is to avoid running the PPCH internal hydropneumatic pump dry for extended periods if the reservoir becomes empty without an operator present. It is also possible to set the PPCH so that operation will not stop when a low level condition is determined (see Section 3.5.7.3.2).

The status of the reservoir low level warning may also be viewed using **[SPECIAL]**, **<7internal>**, **<3pump>**, **<2level>** (see Section 3.5.7.3.2).

The status of the reservoir low level warning can be determined by remote command over the IEEE-488 or RS232 interface (see Section 4.4.3).

3.2.8 OPERATION WITH A PG7000 PISTON GAUGE

PPCH can act as a pressure control component for automatically setting pressure and floating the piston of a PG7302 oil operated piston gauge.

For automated operation, the PPCH communicates with the PG7000 through an RS232 connection from the PG7000 COM3 port to the PPCH COM1 port. Pressure control commands are sent from the PG7000 when it is in “AutoGen” mode (see the PG7000 Operation and Maintenance Manual).

The PPCH may also be operated manually using its direct pressure control keys (see Section 3.1.3).

3.2.9 DIRECT FUNCTION KEYS SUMMARY

Local operation of PPCH is through the front panel keypad. To minimize menu layers, the keypad numerical keys also provide direct access to the most commonly used functions. The function accessed is labeled on the bottom half of the key. Direct function keys are active whenever PPCH is in its MAIN RUN screen. Table 8 summarizes the operation of the direct function keys and Sections 3.3.1 through 3.3.10 detail their operation.













 Table 8 provides a brief summary of direct function key operation. It may be useful to keep a copy of this summary near the PPCH, especially when first becoming acquainted with the instrument's operation.

Table 8. Summary of PPCH function key operation

DIRECT FUNCTION KEYS ARE ACTIVE FROM THE MAIN RUN SCREEN See corresponding manual Sections 3.3.1 through 3.3.10 for full detail.			
	Adjust DUT fluid head height. Set to zero for no fluid head correction.		View active range and toggle through available ranges. [ENT] on a range activates it.
	Run automated test system prime and/or purge routine.		Select pressure unit of measure for the active range. Choice of units available in this menu can be customized.
	Run an automated leak check at the current pressure.		Select the pressure measurement mode for the active range (absolute, gauge).
	Set up and optimize all aspects of PPCH measurement, control and displays for a specific operating range and measurement mode.		Menu of less commonly used internal functions and settings.
	Search for and initialize internal and external Q-RPTs available to the PPCH system.		Menu of commonly used setup features including save/delete AutoRange ranges, set display resolution, adjust jog step size, set upper/lower limit, view AutoTest data, select pressure control mode and adjust control limits, set status of external 12V drivers
	Set up and run automated test sequences.		Input a pressure control set point command from the run screen. ENTER values when editing.

3.3 DIRECT FUNCTION KEYS

3.3.1 [RANGE]

○ PURPOSE

To view and/or change the active pressure measurement range and associated settings.



[RANGE] selects from existing ranges. [AutoRange] creates new ranges (see Section 3.3.4).

○ PRINCIPLE

A PPCH range is defined as a pressure span and associated settings (see Section 3.2.6).

A PPCH may have multiple ranges. Each Q-RPT (and the utility sensor if present) available to the PPCH system has a default range which is its maximum full scale. Additional ranges, lower than the Q-RPT's full scale, may also be created using AutoRange (see Section 3.3.4). Ranges created using AutoRange may be saved with all their settings for reactivation (see Section 3.4.1).

The [RANGE] function key allows the active PPCH range and available ranges to be viewed and selected.

○ OPERATION

Pressing the [RANGE] function key activates the range viewing and selecting function. When the [RANGE] function key is first pressed, the range identification screen for the active range is displayed. For example:

1. Q-RPT or utility sensor designator.
2. Type of range. <DF> for the Q-RPT's default range; <AR> for a range created by AutoRange.
3. Q-RPT or utility sensor position designator.
4. Current pressure unit of measure.
5. Full scale pressure in current unit of measure in gauge and/or absolute measurement mode depending on the measurement modes available.

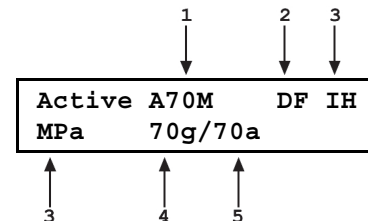

Pressing the [+/-] key or the [RANGE] key again while in the RANGE function toggles through displays of the other available ranges, from lowest range to highest range.

To select a range to become the active range, press [ENT] while the desired range is displayed. PPCH must be vented for the range change to occur. Press [VENT] if necessary to complete the range change.

When selecting a range, if the range's Q-RPT is an external Q-RPT and the PPCH cannot communicate with it, PPCH displays <Cannot find range's external Q-RPT (Xn)> (where <Xn> is the Q-RPT position designator). Use [ENT] or [ESC] to return to the range selection screen. For information on setting up and communicating with external Q-RPTs see Section 2.3.9.1.

Pressing [ESC] while in the RANGE function returns to the MAIN RUN screen with no range change having been made.



Range full scale limits are given in the pressure unit that is currently active for that range. Change the active unit (see Section 3.3.1) to display the range limits in a different unit.



Pressing [+/-] from the MAIN RUN screen provides a shortcut to a momentary view of the range identification screen for the active range.



PPCH saved AutoRange ranges that use Q-RPTs in external RPM4s are available for selection from the [RANGE] key. AutoRange ranges saved locally on the RPM4, are not available on the PPCH [RANGE] key.



Many PPCH settings and functions are range specific. See Table 7 for identification of range specific settings.



To protect against overpressure situations and for maximum measurement performance, the active range can only be changed when the system is vented. If [ENT] is pressed while in the RANGE function when PPCH is NOT vented, the display indicates <Vent system fully to change range>. Pressing the [VENT] key causes PPCH to vent and complete the range change.



Before operating PPCH with external Q-RPTs, check carefully that the external Q-RPT TEST(+) port is connected to the PPCH TEST port. If the external Q-RPT is NOT connected to the PPCH TEST port, it will not measure the pressure generated by PPCH and PPCH may reach a pressure higher than the target pressure before its watchdog function recognizes that the external Q-RPT is not connected.



Take care not to overpressure external Q-RPTs when using them with a PPCH. When using external Q-RPTs in RPM4s as reference pressure measurement devices with a PPCH, the user is responsible to setting up hardware and following procedures to protect lower range Q-RPTs from overpressure. Only the Lo Q-RPT (IL) built-into the PPCH is protected automatically.

3.3.2 [UNIT]

○ PURPOSE

To select the unit of pressure in which PPCH displays pressure values.



For information on selecting the measurement mode (absolute, gauge), see Section 3.3.3.

○ PRINCIPLE

PPCH allows the unit of measure in which pressure values are displayed to be changed.

PPCH supports 15 different pressure units of measure as well as user defined units. To simplify operation, quick access to six unit choices is made available under the [UNIT] key. The default units available depend on whether the PPCH was originally configured as an SI or US version. The [UNIT] key contents can be customized by the user to any configuration of six units (see Section 3.5.6).



Internally, PPCH always operates in Pascal (Pa), the SI unit of pressure. Values of pressure are represented in other units by the application of conversion factors to convert from Pa (see Section 7.2.1).

○ OPERATION

To change the pressure unit of measure for the active range, press **[UNIT]** from the MAIN RUN screen while the range is active. The display is:

1MPa	2kPa	3hPa
4bar	5mbar	6psi

The cursor is on the number corresponding to the pressure unit of measure active for the current range.

To change the pressure unit of measure, select the desired unit. Making the selection returns to the MAIN RUN screen with the selected unit active.



The pressure measurement unit selected is range specific. When in a given range, all functions and settings are represented in the current measurement unit for that range. However, certain internal and/or metrological functions (e.g., Q-RPT calibration coefficients) are always represented in Pa regardless of the active range unit of measure.



See Section 7.2.1 for tables of the conversion factors used by PPCH.



If the pressure unit selected is inWa (inches of water), the reference temperature for water density must be specified in a separate menu (choices are 4°C, 20°C 60°F). No reference temperature selection is necessary for the unit mmWa as the only reference temperature commonly used for mmWa is 4 °C.



The default pressure units of measure available under the UNIT function depend on whether the PPCH has been set up as an SI or US version (indicated by SI or US at bottom right of introduction screen). The choice of six units available under the UNIT function can be customized from a wider selection by the user (see Section 3.5.6). The units available under the UNIT function can be reset to default by reset (see Section 3.5.4.2).

3.3.3 [MODE]

○ PURPOSE

To set the measurement mode (absolute or gauge) for the active range.



For information on selecting the unit of measure, see Section 3.3.2.

○ PRINCIPLE

PPCH supports simple, one-step switching between two measurement modes:

Absolute Measures pressure relative to vacuum (zero is hard vacuum). Range is from zero absolute to full scale. Minimum set pressure is atmospheric pressure (vented).

Gauge Measures pressure relative to atmosphere (zero is ambient pressure) using PPCH's automated offsetting of atmospheric pressure with dynamic compensation for atmospheric pressure changes (see Section 3.2.4). Range is from zero gauge to full scale.

The maximum pressure of each Q-RPT is the same in absolute and gauge measurement modes.

If the Q-RPT will not be used in absolute mode, absolute mode can be turned off to avoid using it unintentionally (see Section 5.3.5).

○ OPERATION

To change the active measurement mode for a range, press **[MODE]** from the MAIN RUN screen while the range is active. The display is:

Measurement mode: 1abs 2gage

Only gauge mode is available if absolute mode is OFF (see Section 5.3.5).

 Certain PPCH settings, including AutoZ ON/OFF (see Section 3.5.1) are range AND measurement mode specific. See Table 7 for a listing of settings and what they are specific to.

 Absolute mode on an PPCH Q-RPT can be turned OFF in the calibration function (see Section 5.3.5). When absolute mode is turned OFF, only gauge mode can be activated. <Gauge mode only, abs mode OFF> is displayed when [MODE] is pressed.

3.3.4 [AUTORANGE]

○ PURPOSE

To automatically set up PPCH to optimize its measurement and control characteristics and other features to cover a specific pressure range.

 [AutoRange] creates new ranges. See [Range] to select from existing ranges (see Section 3.3.1).

○ PRINCIPLE

PPCH is designed to support the calibration and test of a very wide variety of test ranges in various measurement modes with a single pressure controller system.

The AutoRange function simplifies the task of selecting the Q-RPT best suited to cover a specific test range and setting measurement and control parameters appropriately for the range. These are set automatically based on operator entry of desired measurement mode, pressure unit of measure and range full scale. The selections and settings made by AutoRange are summarized in Table 9.

A range set up using AutoRange and all its range specific settings, may be saved for later recall using **[SETUP]**, <1range> (see Section 3.4.1). Saved ranges are available for selection using **[RANGE]** (see Section 3.3.1). If a range created by AutoRange is not saved, it is overwritten by the next AutoRange or erased when another range is selected or PPCH power is turned OFF.

 Use [AutoTest], <1QDUT> to AutoRange PPCH based on DUT tolerance (see Section 3.3.6.2).

Table 9. Settings made by AutoRange

SETTING/SELECTION	PURPOSE	SET TO	SECTION
Unit	Set pressure unit of measure	Operator specified during AutoRange	3.3.2
Mode	Set pressure measurement mode (absolute, gauge)	Operator specified during AutoRange	3.3.3
Full scale	Establish span maximum	Operator specified during AutoRange	None
Q-RPT	Select most appropriate Q-RPT to cover range NOTE: User is responsible for connecting and disconnecting external Q-RPTs, including protecting them from overpressure when using a higher range	Q-PRT with lowest default full scale that is greater than the AutoRange full scale	3.2.5
Upper limit	Set maximum pressure control limit	Upper limit: 105 % of AutoRange range or 102% of Q-RPT default range, whichever is lower	3.4.4
Resolution	Set pressure display resolution	10 ppm of AutoRange span or 1 ppm of default Q-RPT range, whichever is larger.	3.4.2
Control mode	Select dynamic, static, monotonic or ramp pressure control	Standard dynamic control	3.2.2
Control parameters	Set dynamic, static, monotonic and ramp control mode control limits	See Table 10	3.2.2 3.4.6.1
Jog step	Set jog step size	100 ppm of AutoRange span	3.4.3

○ OPERATION

To use the AutoRange function, press **[AutoRange]** and respond to PPCH's prompts.

- ❶ **Select measurement mode:** The screen is identical in appearance and function to the **[MODE]** screen (see Section 3.3.3). Absolute mode is not available if absolute mode is turned off on all available Q-RPTs (see Section 5.3.5).
- ❷ **Select pressure unit of measure:** The screen is identical in appearance and function to the **[UNIT]** screen (see Section 3.3.2).
- ❸ **Enter the AutoRange full scale pressure:** Enter the desired full scale pressure value in the <-----> entry field and press **[ENT]**. If the full scale pressure entered cannot be covered by any of the Q-RPTs available, an error message is displayed. If the full scale pressure can be covered by an available Q-RPT, AutoRange proceeds to the range display.
- ❹ **View proposed AutoRange range:** The proposed AutoRange range screen is:

1. Indication that this is a screen of the proposed AutoRange range.
2. Designator and position of the Q-RPT that AutoRange has selected to cover the AutoRange full scale and measurement mode.
3. Pressure unit of measure specified in AutoRange.
4. AutoRange full scale pressure in gauge mode and absolute mode if available. Shows gauge mode if absolute is OFF for the Q-RPT.

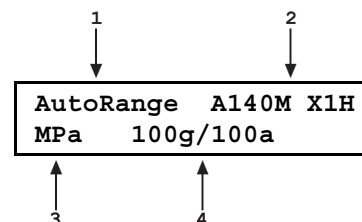



If an external Q-RPT that should be available is not being selected by AutoRange, use [RPT] to search for Q-RPTs and determine whether external Q-RPTs have been properly connected and initialized (see Section 3.3.5). The PPCH utility sensor (luH) cannot be AutoRanged.

⑤ **Accept proposed AutoRange:** To accept the proposed AutoRange and go the MAIN RUN screen with the AutoRanged range active, press [ENT] or [AutoRange]. To modify the AutoRange full scale, measurement mode or pressure unit of measure, use [ESC] to back up through the AutoRange screens and make changes.

If you would like to use a Q-RPT other than the one selected by AutoRange, use [RPT] or the cursor control keys to toggle through the choices available. Only Q-RPTs that can cover the specified full scale and measurement mode are offered. Press [ENT] or [AutoRange] when the desired Q-RPT is displayed.



Before operating PPCH with external Q-RPTs, check carefully that the Q-RPT TEST(+) port is connected to the PPCH TEST port. If the external Q-RPT is NOT connected to the PPCH TEST port, it will not measure the pressure generated by PPCH and PPCH may reach a pressure higher than the target pressure before its watchdog function recognizes that the external RPT is not connected.



Take care not to overpressure external Q-RPTs when using them with a PPCH. When using external Q-RPTs in RPM4s as reference pressure measurement devices with a PPCH, the user is responsible to setting up hardware and following procedures to protect lower range Q-RPTs from overpressure. Only the Lo Q-RPT (IL) built-into the PPCH is protected automatically.



To verify or confirm the active range from the MAIN RUN screen, use [+/-] or [RANGE] to view the active range description (see Section 3.3.1).



See Table 9 for a listing of all selections and settings affected by AutoRange and their default values.

3.3.5 [RPT]

○ PURPOSE

Search for, initialize and display internal and external Q-RPTs available to the PPCH system.

○ PRINCIPLE

Up to six Q-RPTs can be included in a PPCH pressure controller/calibrator system, two internal and four external (see Section 3.2.5). PPCH communicates with external Q-RPTs by RS232 over its COM2 port.

To be available for use by the PPCH system, external Q-RPTs must be identified and initialized. A Q-RPT search function occurs automatically each time PPCH power is cycled. Also, pressing [RPT] initiates the Q-RPT search and allows the Q-RPTs that are available to PPCH to be viewed. Use [RPT] to update the PPCH system configuration if you connect and disconnect Q-RPTs without cycling PPCH power.



See Section 2.3.9.1 for information on hooking up external Q-RPTs to a PPCH system.



Before operating PPCH with external Q-RPTs, check carefully that the Q-RPT TEST(+) port is connected to the PPCH TEST port. If the external Q-RPT is NOT connected to the PPCH TEST port, it will not measure the pressure generated by PPCH and PPCH may reach a pressure higher than the target pressure before its watchdog function recognizes that the external RPT is not connected.



Take care not to overpressure external Q-RPTs when using them with a PPCH. When using external Q-RPTs in RPM4s as reference pressure measurement devices with a PPCH, the user is responsible to setting up hardware and following procedures to protect lower range Q-RPTs from overpressure. Only the Lo Q-RPT (IL) built-into the PPCH is protected automatically.

○ OPERATION

To run the Q-RPT and utility sensor search and initialize function, press **[RPT]**. PPCH displays **<Searching for RPTs...>** while it runs the search function. When the RPT search is complete, the Q-RPTs identification screen is displayed.

1. IH, and L: Identification of RPTs in Internal (PPCH), Hi and Lo positions.
2. X1H and L: Identification of RPTs in External 1 (first RPM4), Hi and Lo positions.
3. X2H and L: Identification of RPTs in External 2 (second RPM4), Hi and Lo positions.

IH:A200Mu	L:none
X1H:A200M	L:A70M
X2H:A40M	L:none

The cursor is on the position designator of the active Q-RPT or utility sensor. Use the cursor control keys to move the cursor to other positions and to view the third line if present. Press **[ENT]** to make the selected Q-RPT or utility sensor active in its default range (see Section 3.2.6). Press **[RPT]** again to cause the Q-RPT search to run again. Press **[ESC]** to return to the MAIN RUN screen without making any changes.



See Table 1 for a listing of Q-RPT designators and their corresponding default ranges and Table 6 for information on Q-RPT system position identification designators.



For PPCH to successfully identify and initialize external RPM4s, the RPM4 COM1 port settings must be:

Baud rate: between 1200 and 19200
 Parity: Even
 Data bits: 7
 Stop bits: 1

If PPCH is not able to establish communications with RPM4s and their Q-RPTs, check that the RPM4 COM1 port setting conform to the requirements above. If the COM1 port settings are correct, check that the correct communications cable is being used (standard pin-to-pin DB-9M to DB-9F RS232) and is connected to the correct communications ports.

PPCH COM2 > 1st RPM4 COM1; 1st RPM4 COM2 > 2nd RPM4 COM1

See the RPM4 Operation and Maintenance Manual for additional information on RPM4 RS232 communications and COM port settings.



When an RPM4 is initialized as an external device to a PPCH pressure controller, the RPM4 front panel keypad is locked out and the second line of the display becomes:

<PPCH EXT DEV: IDLE> (if RPM4 is initialized by PPCH but not currently in use)

<PPCH EXT DEV: ACTIVE> (if RPM4 is initialized by PPCH and is currently in use)

After using an RPM4 as an external device for a PPCH, cycle power to return to the previous RPM4 settings, restore front keypad capability and return to the normal MAIN RUN screen.



Some screens, such as the RPT identification screen, go beyond the two lines provided by the display. Press the cursor control keys to move the cursor to access the lines that are not visible or directly enter the number of the hidden menu choice if you know it. The third line is not included if no 2nd (X2) RPM4 is detected.

3.3.6 [AUTOTEST]

○ PURPOSE

To execute a programmed sequence of automated pressure control target values and/or to AutoRange the PPCH based on the full scale and tolerance of the device under test.

○ PRINCIPLE

The AutoTest function is intended to facilitate the execution of a series of pressure control target values such as is commonly needed when PPCH is used to run a calibration sequence on a device or system being tested.

There are two types of sequences:

Quick Test

Allows quick definition and execution of a sequence **in the current range and using all of the current settings** (pressure unit of measure, measurement mode, control mode, control settings, display resolution).

Quick DUT Test (QDUT)

AutoRanges PPCH based on the full scale and tolerance of a device under test, prompts the user through the increments of a calibration sequence and logs calibration data. The first portion of the QDUT function can be used alone to automatically set **PPCH** range and operating characteristics appropriately for the device under test. The sequence function assumes that the pressure at each target point will be adjusted so that the device under test reads a cardinal target pressure point. This is particularly useful when calibrating analog gauges.

Test sequences are defined by the minimum pressure, maximum pressure and test increment in % of full scale. For tests, in gauge mode, the minimum pressure is always zero. For tests in absolute mode, the minimum pressure is defined by the user.

○ OPERATION

To run an AutoTest press **[AutoTest]** from the MAIN RUN screen.

The display is:

Run an AutoTest: IH
1Quick 2QDUT

Select the test type desired. See Section 3.3.6.1 for Quick Test or Section 3.3.6.2 for QDUT Test.

3.3.6.1 QUICK AUTOTEST

○ OPERATION

To run a Quick Test, press **[AutoTest]** and select **<1Quick>**.

The display is:

```
Run current      IH
QuickTest    1yes 2no
```

This selection provides the choice between running the last Quick Test or setting up a new Quick Test definition. Select **<1yes>** to rerun the last Quick Test. Select **<2no>** to define a new Quick Test.

When **<2no>** is selected from the Run current QuickTest menu, the set-up/edit routine is accessed. The first display is:

1. Entry field for maximum pressure of the Quick Test sequence. Recalls value last entered.

```
Quick Test FS:    IH
50 MPa g
```

↑
1

This entry determines the maximum pressure of the Quick Test sequence. Enter the maximum pressure and press **[ENT]**.



Sequence FS must be less than the pressure upper limit of the active pressure range or an error will occur when the test begins to run. To set up and run a sequence including a pressure greater than the current upper limit, increase the upper limit before running the sequence (see Section 3.4.4) or change to a higher range if available (see Section 3.3.1). To AutoRange the PPCH automatically for a specific sequence based on the characteristics of a DUT, use a QDUT Test (see Section 3.3.6.2).

If the active measurement mode is absolute (see Section 3.3.3), the lowest pressure must also be defined. The next display is:

1. Entry field for minimum pressure of the Quick Test sequence. Recalls last value entered.

```
Quick Test low P  IH
10 MPa a
```

↑
1

This entry determines the lowest pressure of the Quick Test sequence for tests in absolute measurement mode. Note that PPCH vents in response to a command for zero absolute pressure and cannot set pressure under atmospheric pressure (see Section 3.3.10.6). Enter the test lowest pressure point and press **[ENT]**.

The display is:

1. Entry field for sequence pressure increment in % of full scale. Recalls last value entered.

```
Test increment
20.0%FS
```

↑
1

This selection determines the size of the pressure increment in terms of % of the span of the test. The pressure sequence will run in pressure steps of (span x increment %) ending with the uneven increment if applicable.

Enter the desired pressure increment and press [ENT].

The display is:

Test point sequence 1up 2down 3u&d 4d&u
--

This selection determines the order in which the test sequence increments will execute. Selecting <1up> causes the sequence to execute starting at the low point and going to the full scale value.

Selecting <2down> causes the sequence to run starting at the full scale value and going to the low point.

Selecting <3u&d> causes the sequence to run from low point to full scale and back to low point.

Selecting <4d&u> causes the sequence to run from full scale to low point and back to full scale.

After making the increment order selection the display is:

Next point on: 1ENTER 2Timer

This selection determines how the sequence will proceed from point to point when the test is run.

If <1ENTER> is selected, the sequence proceeds to the next target value whenever, and only whenever, [ENT] is pressed.

If <2Timer> is selected, a timer is started at each point when a pressure *Ready* condition is achieved (see Section 3.2.3). The sequence continues to the next pressure point without operator intervention once the timer has expired. After selecting <2Timer>, an additional screen is presented for entry of the timer value in seconds (minimum 1, maximum 999).

After making the next increment on selection, the display is:

1. Indication of minimum and maximum pressure included in the sequence which is about to run.

ENTER to run MPa g 0.000 to 50.000



This screen is offered for the user to check, prior to execution, that the correct sequence is defined and that it does not exceed the range of the device or system being tested. Pressing [ESC] returns to the AutoTest selection screen without sequence execution. Pressing [ENT] causes sequence execution to proceed.

Pressure control begins to set the first target value of the sequence (or vent executes if the first increment is zero). The display is the MAIN RUN Screen with indication of the sequence progress:

1. Indication of sequence increment that is currently being executed / total increments in sequence. Changes to ENTER or countdown time remaining once *Ready* condition has been reached at target value.

8.232 MPa g	IH
T 10.000 D	2/11



Except for the bottom right hand corner, the sequence run display is identical to the normal MAIN RUN screen (see Section 3.1.1). The bottom right corner provides information on sequence execution. This information updates as each sequence increment is completed.

If the sequence was set up with <Next increment on timed delay>, execution proceeds automatically each time a *Ready* condition has occurred at the increment and the countdown timer has expired. If the sequence was set up with <Next increment on ENTER>. Press [ENT] to continue to the next increment.

After the last point of the test sequence has been executed, PPCH vents and operation returns to the main run screen.



Regardless of whether the sequence was set up for next increment on time delay or on ENTER, pressing [ENT] always causes the sequence to proceed to the next increment. This feature can be used to skip one or several increments if desired.

To interrupt the sequence at any time, press [ESC]. Pressure control ceases immediately and the display goes to:

```
Abort Quick AutoTest
1no 2yes
```

Select <2yes> to cause the sequence to abort and return to the MAIN RUN screen. Select <1no> to cause the sequence to resume where it left off.



All Quick Sequences end with a VENT command after the last point. To avoid the VENT, press [ESC] rather than [ENT] after the last point.

3.3.6.2 QDUT AUTOTEST

○ OPERATION

The QDUT AutoTest AutoRanges the PPCH (see Section 3.3.4) based on the span and tolerance of a DUT before running a test sequence. QDUT AutoTest also calculates DUT in or out of tolerance conditions and collects data while running the test. See Section 3.4.5 for information on QDUT AutoTest data files.

To run a QDUT Test, press [AutoTest] and select <2QDUT>.

The display is:

```
Run current QDUT
AutoTest: 1yes 2no
```

This selection provides the choice between running the last QDUT Test, including AutoRanging the PPCH based on the previously entered DUT characteristics or setting up a new QDUT Test definition. Select <1yes> to rerun the last QDUT Test (see below in this Section). Select <2no> to define a new QDUT Test.

When <2no> is selected from the Run Current QDUT Test menu, the set-up/edit routine is accessed. The information needed to AutoRange PPCH based on the DUT characteristics is then collected (see Section 3.3.4).

The first display is the selection of the pressure control mode in which the test is to be run (see Section 3.4.6).

```
Control: 1dynamic
2static 3monotonic
```

Select the pressure control mode that is to be used by the PPCH when running the test points.

The next display is the selection of the measurement mode of the DUT (see Section 3.3.3). If only gauge mode is available, this display is skipped.

```
DUT measurement mode
1abs 2gage
```

Select the measurement mode of the DUT that is being tested. If the desired measurement mode is not available, the QRPTs available to PPCH do not support the measurement mode or it is turned off.

The next display is to specify the unit of measure. Select the unit of measure in which the test is to be run. The choice of units available can be customized (see Section 3.5.6).

1kPa 2Pa 3MPa
4hPa 5bar 6mbar

The next display is to specify the full scale (maximum pressure) of the DUT or test.

1. Entry field for maximum pressure of the QDUT Test sequence.

DUT full scale:
12000 psi g



This entry determines the maximum pressure of the QDUT Test sequence. Enter the maximum pressure and press **[ENT]**.



Sequence full scale must be achievable by a QRPT available to PPCH or an error will occur when PPCH attempts to AutoRange to the specified full scale (see Section 3.3.4).

If the measurement mode selected is absolute, the lowest pressure must also be defined. The display is:

1. Entry field for minimum pressure of the QDUT Test sequence. Recalls last value entered.

DUT low point:
2000 psi a



This entry determines the lowest pressure of the QDUT sequence for tests in absolute measurement mode. Note that PPCH vents in response to a command for zero absolute pressure and cannot set pressure under atmospheric pressure (see Section 3.3.10.6). It is preferable to make the low point, a point that PPCH can set. Enter the test lowest pressure point and press **[ENT]**.

The display is:

1. Entry field for tolerance of the DUT that is being tested in % of the DUT's span.

DUT tolerance:
0.05 %FS (span)



This entry determines the in and out of tolerance limits for the DUT when the test is run. It is also used to determine appropriate PPCH resolution and control limit settings for the resulting AutoRange range.

Enter the DUT tolerance and press **[ENT]**.

The display is:

1. Entry field for sequence pressure increment in % of full scale. Recalls last value entered.

Test increment:
20.0%FS



This selection determines the size of the pressure increment for the test in terms of % of the full scale (FS) value entered in the DUT Full Scale screen. The pressure sequence will run in pressure steps of (full scale x increment %) ending with the uneven increment if applicable.

Enter the desired pressure increment and press **[ENT]**.

The display is:

```
Test point sequence
1up 2down 3u&d 4d&u
```

This selection determines the order in which the test sequence increments will execute. Selecting **<1up>** causes the sequence to execute starting at low point and going to the full scale value.

Selecting **<2down>** causes the sequence to run starting at the full scale value and going to low point.

Selecting **<3u&d>** causes the sequence to run from low point to full scale and back to low point.

Selecting **<3d&u>** causes the sequence to run from full scale to low point and back to full scale.

The next display is the proposed AutoRange range to run the QDUT test (see Section 3.3.4 for additional information on AutoRange).

1. Indication that this is a screen of the proposed AutoRange range.
2. Designator and position of the Q-RPT that AutoRange has selected to cover the QDUT full scale and measurement mode.
3. Pressure unit of measure specified in QDUT setup.
4. AutoRange full scale pressure in gauge mode and absolute mode if available.

```
AutoRange A140M X1H
psi 12000g/12000a
```

Diagram showing arrows pointing to the display elements:

- Arrow 1 points to the top line "AutoRange A140M X1H"
- Arrow 2 points to the top line "AutoRange A140M X1H"
- Arrow 3 points to the bottom line "psi 12000g/12000a"
- Arrow 4 points to the bottom line "psi 12000g/12000a"

The cursor keys or the **[RPT]** key can be used to toggle through other Q-RPTs available to cover the QDUT specified range and measurement mode. When the desired Q-RPT is displayed, press **[ENT]** to accept the proposed AutoRange.

The QDUT AutoTest can now be run.

The display is:

1. Indication of minimum and maximum pressure included in the sequence which is about to run.

```
ENTER to run psi g
0.0 to 10000.0
```

Diagram showing an arrow pointing to the display element:

- Arrow 1 points to the bottom line "0.0 to 10000.0"

This screen is offered for the user to check, prior to execution, that the correct sequence is defined and that it does not exceed the range of the device or system being tested.

Pressing **[ESC]** twice returns to the MAIN RUN screen without sequence execution (this feature can be used to AutoRange the PPCH based on DUT characteristics without running a specific test sequence). Pressing **[ENT]** causes sequence execution to proceed.

The display is:

```
0.000 psi g IH
Prep & ENTER 0/11
```

Perform any operations that are needed before running the test such as making connections or exercising the DUT. The PPCH direct pressure control keys are active to allow pressure adjustment (see Section 3.1.3). When ready to begin the test, press **[ENT]**.

Pressure control begins to set the first target value of the sequence using the pressure control mode specified when setting up the sequence (or vent executes if the first increment is zero). The display is:

1. Indication of sequence increment that is currently being executed / total increments in sequence. Changes to ENTER once Ready condition has been achieved at target value.

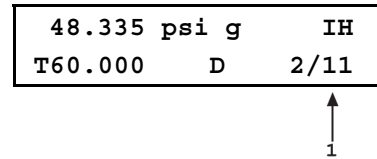

Except for the bottom right hand corner, the sequence run display is identical to the normal MAIN RUN screen (see Section 3.1.1). The bottom right corner provides information on sequence execution. This information updates as each sequence increment is executed.

Once a Ready condition has been achieved (see Section 3.2.3), use the direct manual pressure control keys (\uparrow and \downarrow) to adjust the pressure set by PPCH until the DUT reads the cardinal value of the pressure increment.

Once the DUT indicates the cardinal value of the pressure increment, press [ENT]. The display is:

1. Final target pressure at which DUT indicated cardinal value of the pressure point.
2. <IN> or <OUT> depending on whether DUT was in or out of tolerance. DUT is <IN> if cardinal point - PPCH pressure < DUT tolerance * DUT span.

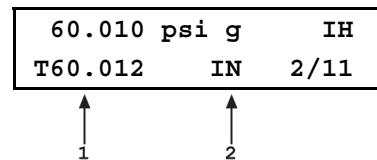

Press [ENTER] to accept this test point and proceed to the next test point or [←] to repeat the point.

Repeat set pressure, take reading and accept data at each point until all points in the sequence have been accepted.

 All QDUT tests end with a VENT command after the last point. To avoid the VENT, press [ESC] after the last point.

After the last point in the sequence has been completed, the display is:

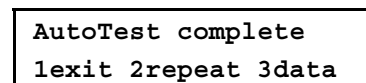

Select <1exit> to go the MAIN run screen retaining the AutoRange that was setup by QDUT.

Select <2repeat> to start the same test again at <Prep & [ENT]>.

Select <3data> to view the data collected in the QDUT AutoTest that was just completed (see Section 3.4.5).

3.3.7 [HEAD]

○ PURPOSE

To cause a pressure fluid head correction to be added to or subtracted from the pressure measured by the PPCH reference pressure transducer in order to predict the pressure at a height other than the PPCH's reference level.

○ PRINCIPLE

PPCH is calibrated at the reference level marked on the instrument rear panel. Frequently, when performing a calibration or test, the device or system under test is at a different height than the PPCH's **TEST** port. This difference in height, commonly called **head**, can cause a significant difference between the pressure measured by the PPCH at its **TEST** port height and the pressure actually applied to the device under test which is at a different height. In this case, it may be useful to make a head correction to the pressure measured by the PPCH in order to predict the pressure actually applied at a DUT at a different height.

PPCH can calculate **head** pressure over its working pressure range for oil, water or a user defined liquid as well as a variety of gasses. The **HEAD** function allows the height difference to be specified and causes the resulting head pressure to be added to the pressure measured at the **TEST** port.

The **[HEAD]** function key is used to specify the height difference between the PPCH reference level and another height. Entering a height of zero turns the function off. The height units and the test fluid are specified by pressing **[SPECIAL]**, **<3Head>** (see Section 3.5.3).

Head influences in gauge and absolute mode with a liquid as the test fluid can be confusing, particularly when using an external reservoir. Follow the recommendations below for consistent results in various setups and measurement modes.

Head Effect Considerations when Using the Internal Reservoir

When the PPCH is vented, it is open to the return tube in the internal reservoir. The top of this tube is intentionally above the normal surface of the liquid in the reservoir and is aligned with the Q-RPT reference level marked on the rear panel. This assures that a consistent head height is applied to the system connected to the PPCH **TEST** port when the system is vented by the **VENT** function of PPCH and that its height is the same as the reference level of the Q-RPT.

- **In both gauge and absolute measurement modes**, enter the difference between the PPCH reference level (marked on the rear panel of PPCH) and the DUT height as the head height in **[HEAD]**. In gauge measurement mode, if you “zero” the device under test (DUT) with the PPCH vented before the test, always enter the head height in **[HEAD]** as zero.
- **In gauge measurement mode**, be sure AutoZ is ON for the active Q-RPT (see Section 3.5.1). Allow PPCH to AutoZero when vented before running a test. Note that if the DUT head height entered in **[HEAD]** is not zero, it is normal for PPCH to display a non-zero value of pressure after AutoZeroing.

Head Effect Considerations when Using an External Reservoir

The external reservoir is normally mounted at a level higher than the PPCH internal reservoir (see Section 2.3.6.2).

- **The reference level is not the same in gauge and absolute measurement modes.**
- **In gauge measurement mode**, enter the difference between the top of the return tube or liquid level in the external reservoir (**not** the level marked on the back of PPCH) and the DUT height as the head height in **[HEAD]**. But, in gauge measurement mode, if you “zero” the device under test (DUT) with the PPCH vented before the test, always enter the head height in **[HEAD]** as zero.
- **In gauge measurement mode**, be sure AutoZ is ON for the active Q-RPT (see Section 3.5.1). Allow PPCH to AutoZero when vented before running a test. Note that if the DUT head height entered under **[HEAD]** is not zero, it is normal for PPCH to display a non-zero value of pressure after AutoZeroing.
- **In absolute measurement mode**, enter the difference between the PPCH reference level (marked on the rear panel of the PPCH) and the DUT height as the head height in **[HEAD]**.

○ OPERATION

To access the HEAD function, press the [HEAD] function key. The display is:

1. Test fluid currently specified for the head correction.
2. Entry field for head height.

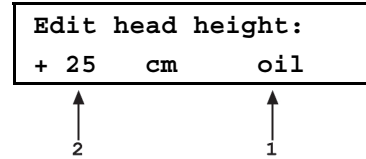

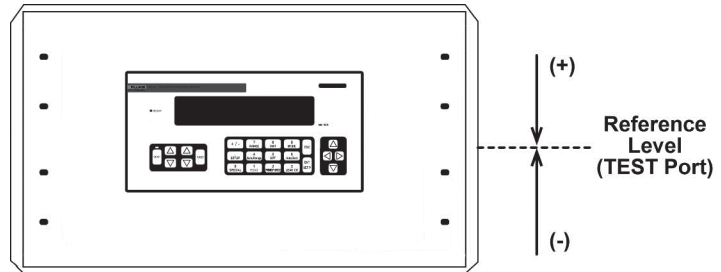

Edit the head height to the desired value (positive if the DUT is above the reference level, negative if below). Press [ENT] to return to the MAIN RUN screen with the new head correction active. Press [ESC] to return with no changes.

 The reference height of the PPCH pressure measurement is the reference level marked on the PPCH rear panel. In gauge measurement mode, when using an external reservoir, the reference level is the top of the reservoir return tube or the liquid in the reservoir if no return tube is installed.



 The HEAD function is NOT range specific. The HEAD ON or OFF status remains the same as ranges are changed. Edits made to the head settings are independent of active range or Q-RPT.

 When a head correction is being applied, it is indicated by <h> in the top line of the MAIN RUN screen (see Section 3.1.1). When the head correction is zero, the <h> is not shown.

 To change units of head height between inches and centimeters and to change the test fluid, use [SPECIAL], <3head> (see Section 3.5.3).

 When using external Q-RPTs in RPM4, it is recommended that the RPM4 head height be adjusted to the reference level of the PPCH before connecting the RPM4. Then, the normal PPCH reference level to DUT head corrections can be made for all the Q-RPTs, whether internal or external to PPCH.

3.3.8 [PRIME]

○ PURPOSE

To execute the PPCH test system PRIME and/or PURGE function. PRIME is intended to fill a test volume with liquid up to a low pressure. PURGE is intended to cycle between a vented condition and high pressure to remove gas from the test system and/or exercise a DUT prior to testing it.

○ PRINCIPLE

PPCH is designed to generate and precisely control liquid pressure. It operates much more effectively in a gas free system. Ideally, devices are filled with liquid prior to being connected to PPCH. The PRIME and PURGE routines are both intended to assist in safely

and efficiently removing any gas that may remain in the test system before using PPCH to control pressure precisely.

Normally, PRIME is used first to fill the system, chasing out gas and priming it to a low pressure. If there is still a possibility of gas being trapped in the system, PURGE is then used to rapidly cycle between vent and a high pressure. At the high pressure, gas mixes with the oil and is drawn out in the vent process.

○ OPERATION

To reach the PRIME and/or PURGE function, press **[PRIME]** from the MAIN RUN screen.

3.3.8.1 <1PRIME>

○ PURPOSE

To run an automated routine that fills the system under test with liquid supplied by the PPCH to drive out as much gas as possible. The routine assumes that the user has opened one or more fittings from which gas can escape at the end of the system connected to the PPCH **TEST** port.

The normal procedure is to start the priming routine from a vented condition while observing an open point (preferably the highest point), such as a loosened fitting, in the test system. PPCH pumps liquid into the system chasing gas out of the test opening. When gas free liquid runs out of the open point, the system is closed by tightening the fitting. Priming aborts automatically when the pressure reaches 0.5 MPa (75 psi).

○ OPERATION

 *The PRIME function interrupts automatically when pressure of 0.5 MPa (75 psi) is sensed. However, the pressure applied to the TEST port may momentarily spike as high as 7 MPa (1 000 psi).*

Prior to running the PRIME routine, connect a system or device to be pressurized to the PPCH **TEST** port. Leave a point open in the system that can be closed by tightening a fitting or closing a valve. Preferably, the open point is at a location in the system to which gas will tend to travel as the system is filled with liquid. Usually, this is a high point.

Vent PPCH by pressing **[VENT]**. Wait for vent to complete as indicated by a green *Ready* indication.

To run the PRIME routine, press **[PRIME]**, **<1prime>**. The display is:

To begin priming, press **[PRIME]**.

0.000 MPa g	IH
[PRIME] to prime	

PPCH supplies liquid to its **TEST** port until **[PRIME]**, **[ESC]** or **[ENT]** is pressed or the pressure reaches 0.5 MPa (75 psi).

0.441 MPa g	IH
*****Priming*****	

If **[PRIME]**, **[ESC]** or **[ENT]** is pressed during priming, the routine interrupts and returns to the **<[PRIME] to prime>** display. Press **[PRIME]** again to continue priming. If the pressure reaches 0.5 MPa (75 psi), the priming routine ends and **<Prime completed>** is displayed

To leave the priming routine press **[ESC]** or **[ENT]** from the **<Prime completed>** screen.

Consider purging after priming (see Section 3.3.8.2).

3.3.8.2 <2PURGE>

○ PURPOSE

To run an automated routine that cycles the pressure rapidly to remove gas from the test system and/or exercise a DUT.

○ OPERATION

 Executing the PURGE function will generate high pressure. The default purge pressure is 50% of the active range. Take appropriate safety precautions before using this function.

Prior to running the PURGE routine, the system connected to the PPCH **TEST** port should be primed if it contains gas (see Section 3.3.8.1). It may also be leak tested (see Section 3.3.9). To run the purge function, press **[PRIME]**, **<2purge>**. The display is:

1. Edit field for the number of times to cycle the pressure. Default is 1.
2. Edit field for cycle high pressure. Default is 50 % of active range. Maximum is 100 % of active range.

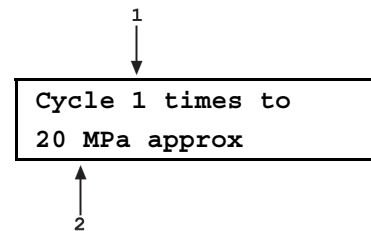

Edit the number of cycles and the cycle pressure as desired. Check carefully that the pressure value entered is acceptable for all the hardware that is connected to the **TEST** port. Press **[ENT]** to begin cycling. The display is:

The top line is the regular run screen displaying the actual pressure. The second line alternates between a display of the target purge pressure (or **<Venting>**) and a display of the current cycle and total number of cycles to be executed.

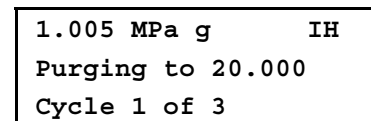

To interrupt the purge routine and return to the prime/purge menu, press **[ENT]** or **[ESC]**. When all cycles of the purge routine have completed, PPCH beeps three times and displays **<Purging complete>**. Press **[ESC]** to go to the MAIN RUN screen or **[ENT]** repeat the purge process.

3.3.9 [LEAK CK]

○ PURPOSE

To run an automated pressure decay based leak check routine to determine the leak rate of the system connected to the PPCH **TEST** port.

○ PRINCIPLE

Leaks in the system connected to PPCH's **TEST** port can cause differences between the pressure measured by the PPCH Q-RPTs and pressure in other parts of the test system. A large leak can cause the PPCH to be unable to set and control pressures reliably. The LEAK CHECK function is provided as a means of checking and quantifying leaks that may be present in the system.

The principle of the LEAK CHECK function is the measurement of the decrease or increase in pressure in a fixed volume over time. The LEAK CHECK function allows a leak check time to be set. The total pressure change and the average rate of change over the leak check time are calculated and displayed.



Changing the pressure in a test system causes adiabatic temperature change in the pressurized liquid that need to have dissipated before a valid leak measurement can be made. In general, a 2 to 3 minute wait before running a leak check is adequate to allow the adiabatic temperature change to dissipate and valid leak measurements to be made. However, stabilization time may be much longer with liquid test media, as volume and/or pressure increases.

○ OPERATION

To run a leak check, first set the pressure to the desired leak check pressure using the direct pressure control keys (see Section 3.1.3) or automated pressure control (see Section 3.3.10).



The effect of the thermal pressure control unit (TPCU) can make it difficult to run a reliable leak test when the PPCH is in dynamic control mode. Before leak testing, change the control mode to a mode other than dynamic and wait at least 5 minutes for the TPCU to cool down and stabilize (see Section 3.4.6.2).

To access the LEAK CHECK function, press **[LEAK CHECK]** from the MAIN RUN screen. Select **<1run>** to run a leak test. The display is:

1. Edit field for the time over which the leak check pressure change will be measured, in seconds.

```
Set leak check time:
15 s
```

↑
1

Edit the leak check time if desired (minimum 1, maximum 999) and press **[ENT]**. Press **[ENT]** again when ready to start the leak test. The leak test display is:

1. Standard MAIN RUN screen first line showing measured pressure.
2. Active RPT position indicator
3. Indication that leak test is running and countdown of time remaining.

```
70.089 MPa a HI
Leak testing 13 s
```

↑
3

[ESC] can be used to abort the running leak test. **[ENT]** while the leak test is running restarts the leak check timer. When the leak check timer countdown has completed PPCH beeps three times and the leak check results screen is displayed:

1. Total pressure change from start to finish of leak check time.
2. Indicator of RPT used to run leak check.
3. Average rate of change of pressure over the leak check time period.

```
ΔP 0.61 MPa HI
Rate 0.04 MPa/sec
```

↑
3

From the leak check results screen, press **[ENT]** to repeat the leak test.

Press **[ESC]** to return to leak check main menu and exit to the MAIN RUN screen.



As a general rule, the maximum acceptable leak rate for optimal PPCH automated pressure control operation and to assure in tolerance measurements with default pressure control parameters is 0.005 % of reading/second. In dynamic control mode, to handle higher test system leak rates, try using hi volume dynamic control (see Section 3.4.6.2) and/or increase the hold limit using [SPECIAL], <6control>, <1limits> (see Section 3.4.6.1).

To view the results of the most recently completed leak check, press <2view>. Press [ENTER] or [ESC] to return to the MAIN RUN screen. If NO leak check data is stored (i.e., if the PPCH has never run a leak test or a reset has cleared previous leak test results), the results screen displays <Data NOT available> briefly and returns to MAIN RUN screen.



Leak check is range specific in the sense that leak check is run using the active range. However, only one set of leak check results is maintained in memory and each leak test completed overwrites the memory. View leak check always shows the results of the last leak check run regardless of the range that is now active. The results screen includes the range indicator to indicate the range in which the leak check was run.

3.3.10 [ENT/SET P] (SET PRESSURE AUTOMATICALLY)

○ PURPOSE

To enter and execute target pressure and ramp values for PPCH automated pressure control.



See Section 3.2.2 for information on automated pressure control and the different control modes available with PPCH.

○ OPERATION

The operation of [ENT/Set P] depends on the active pressure control mode.

Dynamic mode: See Section 3.3.10.1.

Static mode: See Section 3.3.10.2.

Monotonic mode: See Section 3.3.10.3.

Ramp mode: See Section 3.3.10.4.

Interrupting automated pressure control: See Section 3.3.10.5.

Automated commands for zero pressure: See Section 3.3.10.6.



The active range pressure control mode and parameters can be viewed and edited using [SPECIAL], <6control> (see Section 3.4.6).

3.3.10.1 DYNAMIC CONTROL MODE, [ENT/SET P]

If the PPCH is not set for dynamic control, use **SPECIAL**, <6control>, <2mode> to select dynamic control mode.



For best results, wait 5 minutes with the PPCH vented before controlling pressure when changing to or from dynamic control mode. This is to allow time for the PPCH thermal pressure control unit to respond and stabilize.

Press **[ENT/SET P]** from the MAIN RUN screen. The display is:

1. Standard MAIN RUN screen first line showing measured pressure and active Q-RPT.
2. Edit field for the pressure control target pressure in current pressure unit of measure.

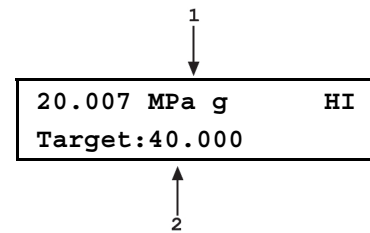

Edit the target pressure value as desired.



A target pressure entry that exceeds the current upper limit (see Section 3.4.4) is not accepted. Negative values are not accepted. See Section 3.3.10.6 for information on zero target value.

Press **[ENT/SET P]** to start pressure control to the target pressure and return to the MAIN RUN screen. The MAIN RUN screen when pressure control is active is:

1. Standard MAIN RUN screen first line showing measured pressure and active Q-RPT. Shows target pressure value when condition is *Ready*.
2. Current control mode indicator. Flashes when automated pressure control is active. Character is **<D>** for standard or **<d>** for hi volume dynamic control. **<C>** is appended if custom control parameters are in use.
3. Target pressure value (**<T>**) when controlling and condition is *Not Ready*. Current deviation from the target pressure (**<D>**) when in dynamic control mode and condition is *Ready*.

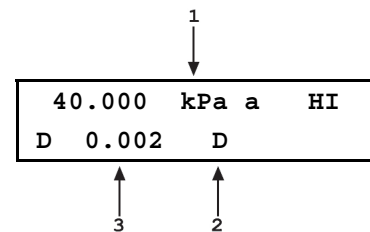

Observe the *Ready/Not Ready* indicator LED (see Section 3.2.3) for indication of when the controlled pressure has reached the target and stabilized inside the hold limit. PPCH continues maintaining pressure at the target value following dynamic control protocol (see Section 3.2.2.2) until automated pressure control is interrupted.



If PPCH is unable to control pressure or appears to control pressure poorly, see Section 6 to troubleshoot. Note that there are two types of dynamic control, standard and hi volume, to accommodate different test situations (see Section 3.2.2.2)



See Section 3.4.6 for information on customizing pressure control parameters.



The **[▲▲]** and **[▼▼]** direct pressure control keys can be used while controlling to jog the pressure control target value up or down by the jog step value (see Section 3.1.3). These keys also jog the target value when in the ENTER target value screen.

3.3.10.2 STATIC CONTROL MODE, **[ENT/SET P]**

If the PPCH is not set for static control, use **SPECIAL, <6control>, <2mode>** to select static control mode.



For best results, wait 5 with the PPCH vented before controlling pressure when changing to or from dynamic control mode. This is to allow time for the PPCH thermal pressure control unit to respond and stabilize.

Press **[ENT/SET P]** from the MAIN RUN screen. The display is:

1. Standard MAIN RUN screen first line showing measured pressure and active Q-RPT.
2. Edit field for the pressure control target pressure in current pressure unit of measure.

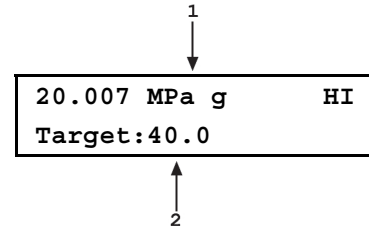

Edit the target pressure value as desired.



A target pressure entry that exceeds the current upper limit (see Section 3.4.4) is not accepted. Negative values are not accepted. See Section 3.3.10.6 for information on zero target value.

Press **[ENT/SET P]** to start pressure control to the target pressure and return to the MAIN RUN screen. The MAIN RUN screen when pressure control is active is:

1. Standard MAIN RUN screen first line showing measured pressure and active Q-RPT.
2. Current control mode indicator. Flashes when automated pressure control is active. Character is **<S>** for static control. **<C>** is appended if custom control parameters are in use.
3. Target pressure value (**<T>**) when controlling and condition is *Not Ready*. Pressure rate of change **<R>** when within hold limit and waiting for pressure stability.

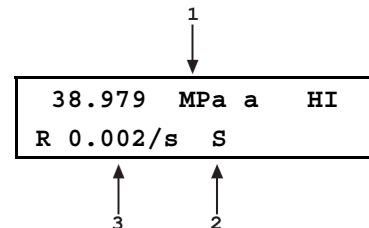

Observe the *Ready/Not Ready* indicator LED (see Section 3.2.3) for indication of when the controlled pressure is within the hold limit and stable. PPCH continues controlling following static pressure control protocol (see Section 3.2.2.3) until automated pressure control is interrupted.



If PPCH is unable to control pressure or appears to control pressure poorly, see Section 6 to troubleshoot.



See Section 3.4.6 for information on customizing pressure control parameters.



The **[▲]** and **[▼]** direct pressure control keys can be used in static mode while the PPCH is waiting for pressure stability to jog the pressure by the pressure step value (see Section 3.1.3). These keys also jog the target value when in the ENTER target value screen.

3.3.10.3 MONOTONIC CONTROL MODE, [ENT/SET P]

If the PPCH is not set for monotonic control, use **SPECIAL**, **<6control>**, **<2mode>** to select monotonic control mode.

 Use monotonic control with caution. Once pressure is set to the target, an ascending monotonic ramp will continue increasing pressure until stopped by a new pressure command, aborting control or reaching the active range upper limit pressure (see Section 3.4.4).

 For best results, wait 5 minutes with the PPCH vented before controlling pressure when changing to or from dynamic control mode. This is to allow time for the PPCH thermal pressure control unit to respond and stabilize.

Press **[ENT/SET P]** from the MAIN RUN screen. The display is:

1. Standard MAIN RUN screen first line showing measured pressure and active Q-RPT.
2. Edit field for the pressure control target pressure in current pressure unit of measure.

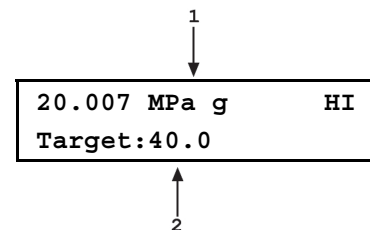

Edit the target pressure value as desired.

 A target pressure entry that exceeds the current upper limit (see Section 3.4.4) is not accepted. Negative values are not accepted. See Section 3.3.10.6 for information on zero target commands.

Press **[ENT/SET P]** to start pressure control to the target pressure and return to the MAIN RUN screen. The MAIN RUN screen when pressure control is active is:

1. Standard MAIN RUN screen first line showing measured pressure and active Q-RPT. Always shows measured pressure.
2. Current control mode indicator. Flashes when automated pressure control is active. Character is **<M>** for monotonic control. **<C>** is appended if custom control parameters are in use.
3. Target pressure value (**<T>**) at all times.

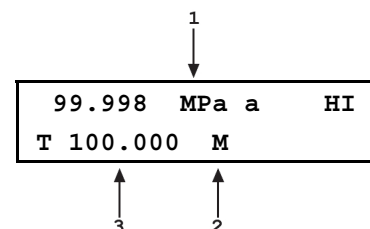

Observe the *Ready/Not Ready* indicator LED (see Section 3.2.3) for indication of when the controlled pressure is at the target pressure and under the monotonic ramp rate target. PPCH continues controlling following monotonic pressure control protocol (see Section 3.2.2.4) until automated pressure control is interrupted.

 If PPCH is unable to control pressure or appears to control pressure poorly, see Section 6 to troubleshoot.



See Section 3.4.6 for information on customizing pressure control parameters.

3.3.10.4 RAMP CONTROL MODE, [ENT/SET P]

If the PPCH is not set for ramp control, use **SPECIAL**, <6control>, <2mode> to select ramp control mode.



Use ramp control with caution. An ascending ramp will not stop increasing pressure until stopped by a new pressure command, aborting control or reaching the active range upper limit pressure (see Section 3.4.4).



For best results, wait 5 minutes with the PPCH vented before controlling pressure when changing to or from dynamic control mode. This is to allow time for the PPCH thermal pressure control unit to respond and stabilize.

Press **[ENT/SET P]** from the MAIN RUN screen. The display is:

1. Standard MAIN RUN screen first line showing measured pressure and active Q-RPT.
2. Edit field for the target ramp rate in current pressure unit of measure per second.

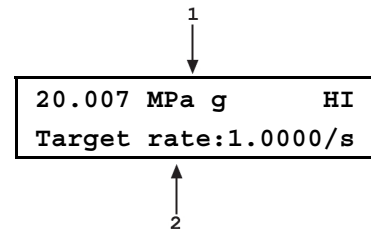

Edit the target ramp value as desired. Enter a negative value for a descending rate.



A rate entry of 0 is not accepted.

Press **[ENT/SET P]** to start pressure control to the target ramp rate and return to the MAIN RUN screen. The MAIN RUN screen when pressure control is active is:

1. Standard MAIN RUN screen first line showing measured pressure and active Q-RPT. Always shows measured pressure.
2. Actual pressure rate of change (<R>) at all times.
3. Current control mode indicator. Flashes when automated pressure control is active. Character is <R> for ramp control. <C> is appended if custom control parameters are in use.

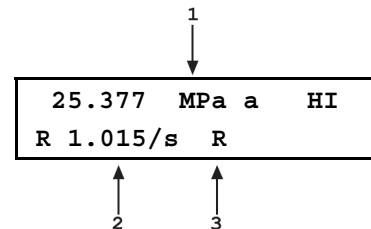

Observe the *Ready/Not Ready* indicator LED (see Section 3.2.3) for indication of when the target rate has been established within the rate hold limit. PPCH continues controlling following ramp pressure control protocol (see Section 3.2.2.5) until automated pressure control is interrupted.



If PPCH is unable to control pressure or appears to control pressure poorly, see Section 6 to troubleshoot.



See Section 3.4.6 for information on customizing pressure control parameters.

3.3.10.5 INTERRUPTING AUTOMATED PRESSURE CONTROL

Automated pressure control is interrupted by:

- **Pressing [ESC]:** Suspends control and remains in MAIN RUN screen. Does not vent pressure. PPCH passively measures the pressure applied to its TEST port. Pressure may take some time to stabilize if control mode is dynamic as thermal pressure control unit stabilizes.
- **Pressing any direct pressure control key other than the jog keys (see Section 3.1.3):** Suspends control and executes direct pressure control.
- **Pressing any function key:** Suspends control and goes to the selected function. Does not vent pressure. PPCH passively measures the pressure.
- **Pressing [ENT/SET P]:** In dynamic, static and ramp modes, suspends control and goes to ENTER target screen. Does not vent pressure. PPCH passively measures the pressure. In monotonic mode, [ENT/SET P] suspends control only if the pressure has not yet reached the target limit. [ENT/SET P] does not suspend control during the slow ramp after the target pressure has been reached. This is to avoid suspending control when setting the next pressure increment as that could cause the direction of pressure evolution to reverse, violating the monotonic excursion.
- **Sending any remote command when in local mode** interrupts pressure control.

To resume automated pressure control, press [ENT/SET P] and ENTER a target pressure value.

3.3.10.6 AUTOMATED PRESSURE COMMANDS FOR ZERO PRESSURE

A command for automated pressure control to a target value of zero when in gauge or absolute measurement mode is interpreted in the same manner as if the [VENT] direct pressure control key had been pressed (see Section 3.1.3). A Ready condition occurs when the vent sequence has completed, including running AutoZ, if applicable (see Section 3.5.1). Zero is not an accepted entry in ramp control mode.



PPCH cannot set pressure under atmosphere. An automated pressure control command for zero pressure in absolute measurement mode results in setting atmospheric pressure by opening the TEST port to atmosphere. This is the lowest absolute pressure PPCH can set. When zero absolute is given as a pressure target, the pressure actually measured by the PPCH after the ready condition occurs must be read back rather than assuming a specific pressure value has been set.

3.4 [SETUP]

○ PURPOSE

[SETUP] accesses a menu of functions and features commonly used in setting up and using PPCH.

○ OPERATION

To access the SETUP menu, press [SETUP] from the MAIN RUN screen. The display is:

```
1range 2res 3jog 4UL
5ATest 6control 7drv
```

SETUP menu choices include:

- <1range> Save and delete ranges created by AutoRange (see Section 3.4.1).
- <2res> Adjust the resolution of pressure displays (see Section 3.4.2).
- <3jog> Adjust the jog function pressure step value (see Section 3.4.3).
- <4UL> Adjust the upper pressure limit (see Section 3.4.4).
- <5ATest> View data files resulting from running QDUT AutoTests (see Section 3.4.5).
- <6control> Select pressure control mode and view/adjust control limits (see section 3.4.6).
- <7drv> Set and view status of external 12V drivers (see Section 3.4.7).

3.4.1 <1RANGE>

○ PURPOSE

Save AutoRange ranges and associated settings for recall. Delete previously saved AutoRange ranges.

○ PRINCIPLE

The PPCH AutoRange function creates a range and automatically sets various operating parameters proportionally to the range (see Section 3.3.4). Operating settings can then be changed by the user. Many operating settings are specific to the current range (see Table 7).

[SETUP], <1range> allows the AutoRange range and associated settings to be saved for later recall using the [RANGE] key (see Section 3.3.1). This can save the user from having to recreate frequently used ranges and custom settings.

[SETUP], <1range> is also used to delete ranges that have been saved but are no longer needed.

3.4.1.1 SAVING AN AUTORANGE RANGE

○ OPERATION

To save a range created by AutoRange, the range must be the active range. Use AutoRange to create the range (see Section 3.3.4) and then make any desired feature and setting adjustments.

Once the AutoRange range is set up as desired, press [SETUP], <1range> and select <1save>. The display is:

1. Indication that this is an AutoRange range to be saved.
2. Designator and position of the Q-RPT used by the range to be saved.
3. Pressure unit of measure of the range to be saved.
4. Full scale pressure of the range to be saved in gauge mode and absolute mode if available.

```

      1           2
      ↓           ↓
Save range A100M IH
MPa   80g/80a
      ↑           ↑
      3           4

```

Press **[ENT]** to save the range or **[ESC]** to return to the MAIN RUN screen without saving the range.



Default (DF) Q-RPT ranges cannot be saved. They are permanent.

Duplicate AutoRange ranges cannot be saved. A duplicate AutoRange range is a range that has the same measurement mode and full scale and uses the same Q-RPT as a range that has already been saved.

3.4.1.2 DELETING AUTORANGE RANGES

○ OPERATION

To delete a single saved AutoRange range, press **[SETUP]**, **<1range>**, **<2delete>**. If there are any saved ranges available to delete, the display is:

1. Indication that the cursor control keys may be used to toggle through the saved ranges to select the one to be deleted.
2. Designator and position of the Q-RPT used by the range to be deleted.
3. Pressure unit of measure of the range to be deleted.
4. Full scale pressure of the range to be deleted in gauge mode and absolute mode if available.

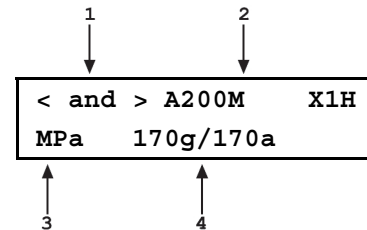

Use the cursor control keys to toggle through the ranges available to be deleted. When the desired range to be deleted is displayed, press **[ENT]**. If you are sure you want to delete this range, press **[ENT]** again in response to the **<Delete?>** query. Press **[ESC]** to return to the **<AutoRange:>** screen without deleting a range.

To delete all of the saved AutoRange ranges, press **[SETUP]**, **<1range>**, **<3delete all>**. If you are sure you want to delete all the ranges, respond **<1yes>** to the **<Delete all saved ranges?>** query. If not, respond **<2no>**.

3.4.2 <2RES> (RESOLUTION)

○ PURPOSE

To set the resolution with which measured pressures and other pressure indications and settings are displayed.

○ PRINCIPLE

The resolution with which PPCH displays pressure values can be adjusted. This feature can be used to reduce the resolution when lower precision measurements are being made and excess resolution might confuse or distract the operator.

The resolution setting determines the number of digits with which pressure is displayed. The resolution is calculated based on the full scale of the range and then rounded to the furthest digit to the right. For example, resolution of 0.001 % on a range of 150 MPa is $150 \times 0.001 \% = 0.0015$ which is rounded down to 0.001 MPa.



Default resolution is 10 ppm of active range span. Resolution is set automatically by AutoRange (see Section 3.3.4).

○ OPERATION

To access the resolution function, press **[SETUP]**, **<2res>**. The display is:

Display resltn:	IH
0.0010 %FS	< and >

Use the cursor control keys to set the desired level of resolution. Press **[ENT]** to return to the MAIN RUN screen with the new resolution setting active or **[ESC]** to make no changes.



The resolution setting is range specific. A resolution setting made in one range does NOT affect other ranges.



The maximum resolution setting is limited in AutoRange ranges that are less than 10 % of the Q-RPT default full scale.



The maximum resolution setting when using a utility sensor is 0.001 % of utility sensor span.

3.4.3 <3JOG>

○ PURPOSE

Adjust the nominal change in pressure caused by using the jog direct pressure control keys (**[△]** and **[▽]**).

○ PRINCIPLE

The jog direct pressure control keys, **[△]** and **[▽]**, increase or decrease pressure by a nominal amount each time they are pressed. If pressure control is NOT active, pressing the jog key causes an up or down pressure step. If dynamic pressure control is active, the jog key causes the pressure control target value to be changed by the amount of the jog step. **[SETUP]**, **<3jog>** allows the nominal value of the jog step to be adjusted.



The default jog step is 0.02% of active range span. The maximum jog step is 5 % of active range span. Jog step value is set automatically by AutoRange (see Section 3.3.4).



See Section 3.1.3 for information on the jog key effect while control is active in various control modes.

○ OPERATION

To access the jog step adjustment function, press **[SETUP]**, **<3jog>**. The display is:

Jog step size:	IH
0.010 MPa	

Edit the value of the jog step as desired. Press **[ENT]** to return to the MAIN RUN screen with the new jog step size active. Press **[ESC]** to return to the MAIN RUN screen with no change to the jog step size.



Pressing **[△]** and **[▽]** simultaneously is a short cut to the **<Jog step size:>** menu.



The jog step setting is range specific. A jog step setting made in one range does NOT affect other ranges.

3.4.4 <4UL> (UPPER LIMIT)

○ PURPOSE

To set the upper limit pressure value for a pressure range and measurement mode.

○ PRINCIPLE

The UPPER LIMIT function allows the setting of a maximum pressure not to be exceeded when using a specific range and measurement mode. Absolute and gauge measurement modes (see Section 3.3.3, ○ PRINCIPLE) have their own, specific limits.

Automated pressure control targets greater than the upper limit are not accepted. When the pressure measured by PPCH exceeds the upper limit, automated or direct manual pressure control is aborted and an intermittent warning beep sounds.

The UPPER LIMIT function is most often used to protect the device or system connected to the PPCH **TEST** port from accidental overpressure.



The default upper limit is 105 % of AutoRange span or 102 % of Q-RPT default (maximum) full scale, whichever is lower.



The upper limit is very useful in assuring that the pressure ramps of monotonic or ramp pressure control modes do not result in an accidental overpressure.

○ OPERATION

To view or edit the upper limit press **[SETUP]**, **<4UL>**.

The display is:

1. Entry field for upper limit value in active pressure unit of measure and measurement mode.

Upper limit:	IH
204.000 MPa a	



Edit the upper limit value as desired. The maximum upper limit is 105 % of AutoRange range or 102 % of default QRPT range, whichever is lower. Press **[ENT]** to return to the MAIN RUN screen with the new upper limit active. Press **[ESC]** to return to the MAIN RUN screen with no change to the upper limit.

When the upper limit has been exceeded, the display of current pressure flashes and a buzzer sounds at 2 second intervals. To return to normal operation, reduce pressure using direct pressure control keys or an automated pressure command.



Upper limit values are specific to each range and measurement mode. Be careful not to assume that the upper limit set in one measurement mode will apply to the other. For example, if you set 100 MPa as the upper limit in gauge mode, the upper limit will not be 100 MPa in absolute mode of the same range.



Upper limits are always specified and displayed in the current pressure unit of measure.

3.4.4.1 OVER PRESSURE FUNCTION

In addition to the UL function, PPCH has an over pressure function.

The over pressure function executes when a Q-RPT measures a pressure that is 104 % of its default span or a utility sensor measures a pressure that is 110 % of its default span.

When PPCH is using an external Q-RPT in an RPM4, the PPCH utility sensor or Hi Q-RPT acts as a watchdog. If the watchdog measures a pressure greater than the maximum pressure of the active external Q-RPT, PPCH executes the overpressure function.

The over pressure function causes all pressure control to be interrupted, changes the active range to the default range of the Internal, Hi (IH) Q-RPT or utility sensor and causes the measured pressure display to flash. The overpressure function also logs the time and date of the overpressure condition in both user and factory logs to assist in incident diagnosis (see Section 3.5.9).

To recover from an overpressure, correct the overpressure condition and cycle PPCH power. Be sure to correct the condition that caused the overpressure before cycling power.



RPM4 has its own, independent overpressure function. When a Q-RPT on an RPM4 is active, both the PPCH and the RPM4 may execute overpressure routines in response to an overpressure condition of the RPM4. See the RPM4 Operation and Maintenance Manual for information on the RPM4 overpressure function.

3.4.5 <5ATEST>

○ PURPOSE

To view the data files that are created when QDUT AutoTests are run (see Section 3.3.6).

○ PRINCIPLE

PPCH supports QDUTAutoTests (see Section 3.3.6.2). When a QDUT AutoTest is run, the PPCH pressure accepted by the operator, and <IN> or <OUT> condition, at each point is logged. The logged pressure and an identifying header are stored in a data file. The data file can be viewed immediately following the last point of the sequence by selecting <3data>. In addition, the up to ten previous data files recorded can be viewed anytime using **[SETUP]**, <5ATest>.

Data File Protocol

Up to ten QDUT AutoTest data files are buffered, ten at a time, in PPC3 memory. When a new test is completed, its data file goes to the front of the queue and the oldest data file is deleted.

Data files are identified by a header whose first line is the full scale of the DUT and the number of test points in the QDUT AutoTest sequence. The second line is the date (YYYYMMDD) and time (HH:MM:SS) at which the last point of the sequence was accepted.

Following the data file header, each test point is recorded including the pressure setting of the PPCH with head, AutoZ and range status as well as an indication of whether the reading was in or out of tolerance and the test point number over the total number of test points in the QDUT sequence.

○ OPERATION

To access the QDUT AutoTest data file viewing function press **[SETUP]**, **<5ATest>**.

The first display is the data file header which can be used to toggle through data files:

1. Full scale of the QDUT AutoTest sequence with pressure unit of measure and measurement mode.
2. Number of test points completed / total number of test points in the sequence definition.
3. Date (YYYYMMDD) and time the last point was completed.

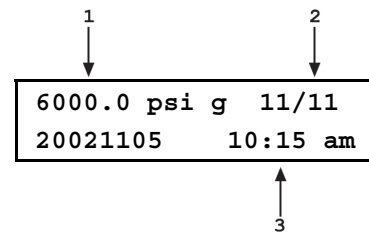

Use the forward and backward cursor control keys to scroll through the headers of the other QDUT AutoTest data files available. PPCH stores up to ten data files in order of execution with a new data file pushing all the files back and deleting the oldest one. When the header of the data file you would like to view appears, press **[ENT]** or the down cursor control key to view the first point of the identified sequence.

The display is:

1. PPCH pressure logged for the test point.
2. Head, AutoZ and active Q-RPT indicator (same as in the PPCH MAIN RUN screen).
3. Indication that this point was out of tolerance. Indicates **<IN>** if point was in tolerance. Definition of out of tolerance is (Nominal point – PPC pressure > DUT tolerance * DUT FS).
4. Number of this test point / total number of points in the sequence.

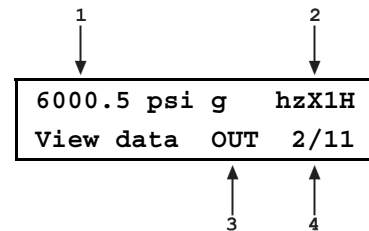

Press **[ENT]** to move to the next data point or use the up and down cursor control keys to scroll backwards and forwards through the test points. The data file header is between the first point and the last point.

Press **[ESC]** to exit the data file. Confirmation is required to exit the data view function.

3.4.6 <6CONTROL>

○ PURPOSE

To set the automated pressure control mode for the active range, customize control parameters for the active control mode, activate default control parameters.

○ PRINCIPLE

The CONTROL function allows the active control mode for the current range to be set to dynamic (standard or hi volume), static, monotonic or ramp. The control mode set is specific to the active range and is saved with that range when ranges are changed. For a complete description of the operation and purpose of the different control modes see Section 3.2.2.

When a control mode is selected using the CONTROL function, CONTROL parameters are automatically set to default values for that control mode in the active range (see Table 10 for definition of PPCH default control parameters). The default control parameters are those best suited to operate within PPCH pressure control and measurement specifications for a given range of operation.

Control mode parameters can be viewed and customized in the CONTROL function (see Section 3.4.6.). Customizing the control parameters changes the conditions required for a *Ready* condition to occur (see Section 3.2.3). This can be used to increase control speed (reduce time to *Ready*), usually by decreasing control precision, or to increase precision which usually decreases control speed. For example, changing the dynamic pressure control hold limit from its default value of $\pm 0.01\%$ of the active range to $\pm 0.05\%$ of the active range decreases the time required to set a pressure since the limit within which the pressure must

be set has increased. However, it will also increase the maximum possible control error when Ready is indicated.

Table 10. Default pressure control parameters

	HOLD LIMIT	PRESSURE STABILITY LIMIT	PRESSURE TARGET LIMIT	RATE LIMIT
DYNAMIC MODE (standard and hi volume)	± 0.01 % of active range, or 0.003 % of Q-RPT maximum span, whichever is greater	Not applicable	Not applicable	Not applicable
STATIC MODE	± 1 % of active range	± 0.005 % of active range or 2 ppm of Q-RPT maximum span/second, whichever is greater	Not applicable	Not applicable
MONOTONIC MODE	Not applicable	Not applicable	1 % of Q-RPT maximum span	0.05 % of Q-RPT maximum span/second
RAMP MODE	± 25 % of target rate	Not applicable	Not applicable	Not applicable
CONTROL IDLE	Not applicable	± 0.005 % of active range or 2 ppm of Q-RPT maximum range/second, whichever is greater	Not applicable	Not applicable

*Note: % of range limits are of default or AutoRanged range.

○ OPERATION

To access the CONTROL function, press **[SETUP]**, **<6control>**. The display is:

Dynamic, standard IH 1limits 2mode

Select **<1limits>** to view or edit the active control limits for the active control mode (see Section 3.4.6.1).

Select **<2mode>** to change the active control mode (see Section 3.4.6.2).

3.4.6.1 <1LIMITS> (CUSTOM CONTROL PARAMETERS)

○ PURPOSE

To view active pressure control parameters and/or set custom control parameters.

○ PRINCIPLE

See Section 3.4.6, ○ PRINCIPLE.

○ OPERATION



[SETUP], <6control>, <1limits> views and/or sets limits for the active control mode only. To set limits for a control mode other than the active control mode, select that control mode first using [SETUP], <6control>, <2mode>.

To view active control parameters and/or set custom control parameters, press **[SETUP]**, **<6control>**, **<1limits>** from the MAIN RUN screen. The display is depends upon the active control mode.



To reset default control parameters for a range and control mode, select the control mode using [SETUP], <6control>, <2mode>.



Custom control parameters are range specific. Changes made in one range are stored for that range and are recalled when that range is made active. Changes made in one range do not affect any other range.



When custom control parameters are active, a <C> is appended to the control mode indicating character (<D> for standard dynamic, <d> for hi volume dynamic, <S> for static, <M> for monotonic, <R> for rate) in the middle of the bottom line of the MAIN RUN screen.

Dynamic (standard and hi volume) and Static Control Modes

When dynamic or static control mode is active, the [SETUP], <6control>, <1limits> display is:

1. Active Q-RPT designator.
2. View/edit field of hold limit value in active pressure unit of measure. Shows active hold limit.
3. Active control mode (<D> for standard dynamic, <d> for hi volume dynamic, <S> for static).

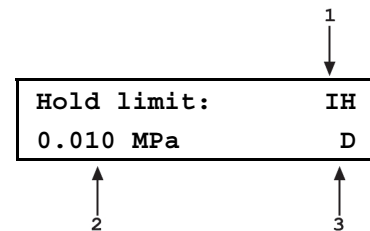

Edit the hold limit value if desired and press [ENT] to view the stability limit. The next display is:

1. Active Q-RPT designator.
2. View/edit field of stability limit value in active pressure unit of measure. Shows active stability limit.
3. Active control mode (<D> for standard dynamic, <d> for hi volume dynamic, <S> for static).

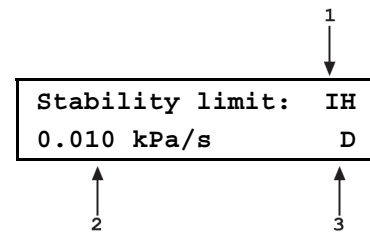

Edit the stability limit value if desired and press [ENT] to return to the main run screen with the edited values active.

See Section 3.4.6, Table 10 for default control limits.

Monotonic Control Mode

When monotonic control mode is active, the [SETUP], <6control>, <1limits> display is:

1. Active Q-RPT designator.
2. View/edit field of pressure target limit value in active pressure unit of measure. Shows active target limit.
3. Active control mode (<M> for monotonic).

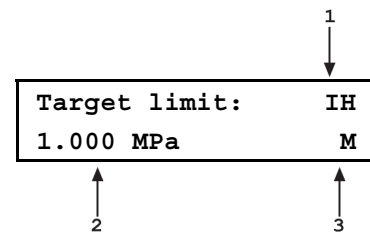

Edit the target limit value if desired and press [ENT] to view the monotonic ramp rate limit. The next display is:

1. Active Q-RPT designator.
2. View/edit field of monotonic ramp rate limit in active pressure unit of measure per second. Shows active rate limit.
3. Active control mode (<M> for monotonic).

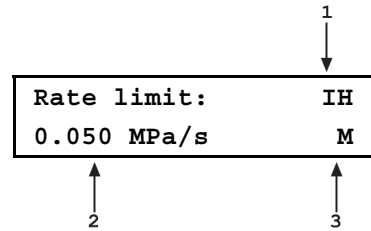

Edit the target ramp rate if desired and press **[ENT]** to return to the main run screen with the edited values active.

See Section 3.4.6, Table 10 for default control limits.

Ramp Control Mode

When ramp control mode is active, the **[SETUP]**, **<6control>**, **<1limits>** display is:

1. Active Q-RPT designator.
2. View/edit field of pressure ramp rate hold limit value in active pressure unit of measure per second.
3. Active control mode (<R> for ramp).

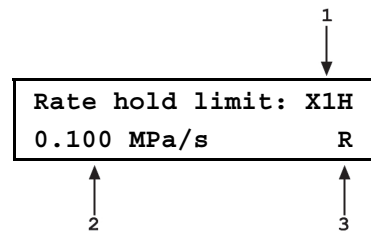

Edit the ramp rate hold limit value if desired and press **[ENT]** to return to the main run screen with the edited values active.

See Section 3.4.6, Table 10 for default control limits.

3.4.6.2 <2MODE>

○ PURPOSE

To select the active automated pressure control mode.

○ PRINCIPLE

See Section 3.4.6, ○ PRINCIPLE.

○ OPERATION

The control mode selection display is:

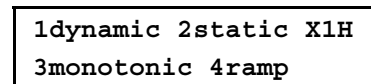

The cursor is on the active control mode. Making a control mode selection activates the control mode, sets default control parameters for that control mode (see Section 3.4.6, Table 10) and returns to the main run screen. To set custom control parameters, press **[SETUP]**, **<6control>**, **<1limits>** from the MAIN RUN screen (see Section 3.4.6.1).

Dynamic control mode selection, standard or hi volume

When **<1dynamic>** is selected, the type of dynamic control (standard or hi volume) must be specified (see Section 3.2.2.2).

After selecting **<1dynamic>**, display is:

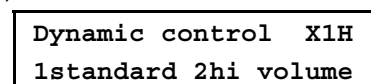

Select the desired dynamic control mode type. The default is **<1standard>**. Making a control mode selection activates the control mode, sets default control parameters for that control mode.



For best results, wait 5 minutes with the PPCH vented before controlling pressure when changing to or from dynamic control mode. This is to allow time for the PPCH thermal pressure control unit to respond and stabilize.



Control mode setting is range specific. A change in control mode made while in one PPCH range does NOT affect the control mode setting in other ranges.



The current control mode is indicated by two characters in the middle of the bottom line of the MAIN RUN screen (<D> for standard dynamic, <d> for hi volume dynamic, <S> for static, <M> for monotonic, <R> for ramp, with <C> appended if custom control settings are in use). (See Section 3.1.1)

3.4.6.3 TURNING-OFF CUSTOM CONTROL PARAMETERS

To return to default pressure control parameters for the active range and control mode, select the control mode using **[SETUP]**, **<6control>**, **<2mode>** (see Section 3.4.6). Selecting the mode automatically activates its default control parameters. This is a convenient way to put the PPCH into a known condition after trying custom control settings.

3.4.7 <7DRV> (DRIVERS)

○ PURPOSE

To control the output signals of PPCH's 8 channel, 12 V external drivers.

○ PRINCIPLE

PPCH external drivers are available to drive peripheral equipment in a PPCH system, for example, solenoid valves. The driver electrical connections are available from a rear panel connector.



See Section 7.1 for driver specifications and connector pin-outs.

○ OPERATION

To access the driver control function press **[SETUP]**, **<7drv>**. The display is:

External drivers: 1							
2	3	4	5	6	7	8	

Pressing the keypad numerical key driver number turns that driver ON and OFF with either a momentary or a toggled response. An active driver is indicated by **<*>** immediately following the driver number.

Pressing **[ENT]** while in the external drivers menu causes a menu to appear that allows selection of whether the driver actuation by selecting the driver number will be **<1momentary>** or **<2toggle>**.

3.5 [SPECIAL]

○ PURPOSE

[SPECIAL] accesses a menu of PPCH settings, adjustment and features that are less commonly used or not normally used in regular operation.

○ OPERATION

Press [SPECIAL] from the MAIN RUN screen to access the SPECIAL menu. The display is:

```
1AutoZ 2remote 3head
4reset 5pref 6Punit ↓
7internal 8cal 9log
```



Some screens, such as the SPECIAL menu, go beyond the two lines provided by the display. This is indicated by a flashing arrow in the second line of the display. Press the cursor control keys to move the cursor to access the lines that are not visible or directly enter the number of the hidden menu choice if you know it.

SPECIAL menu choices include:

- <1AutoZ> Manage AutoZero function for the active Q-RPT or utility sensor (see Section 3.5.1).
- <2remote> View and edit PPCH COM port (RS-232) and IEEE-488 interface settings (see Section 3.5.2).
- <3head> Set HEAD function fluid and height unit of measure (see Section 3.5.3).
- <4reset> Access PPCH's various reset functions (see Section 3.5.4).
- <5pref> View and set screen saver time, keypad sound frequency, unit ID number, time/date, security protection level (see Section 3.5.5).
- <6Punit> Customize the [UNIT] key pressure unit of selections (See section 3.5.6).
- <7intern> Access internal functions including control configurations, on-board barometer viewing, pump and reservoir functions (see Section 3.5.7).
- <8cal> View and adjust RPM3 utility sensor, Q-RPT and barometer calibration coefficients (see Sections 3.5.8 and 5.2).
- <9log> View the PPCH incident log (see Section 3.5.9).

3.5.1 <1AUTOZ>

○ PURPOSE

To offset the PPCH system Q-RPTs relative to a reference value in order to compensate for possible changes in Q-RPT zero between full recalibrations.

○ PRINCIPLE

AutoZ Purpose and Principle

The main component of the change over time of the PPCH Q-RPTs is change in zero or offset, independent of span. Offsetting or “rezeroing” PPCH Q-RPTs relative to a reference between recalibrations allows measurement uncertainty specifications to be maintained with less frequent full calibrations. The PPCH AutoZero function (AutoZ) provides full on-board support for the rezeroing process to simplify its application by the user.

The AutoZero function uses three values:

1. **P_{std,0}**: The pressure value indicated by the AutoZ reference, the device that is acting as the reference relative to which to offset the Q-RPT.

In **absolute measurement mode**, the pressure at which AutoZ is performed is normally atmospheric pressure and the $P_{std,0}$ value can be supplied by manual entry.

In **gauge measurement mode**, $P_{std,0}$ is always zero (atmospheric pressure) which is supplied by definition when the Q-RPT is vented to atmosphere.

- $P_{u,0}$: The pressure reading of the Q-RPT, with no AutoZ offset, at the time AutoZ is performed.
- $P_{offset,G}$ and $P_{offset,A}$: The difference between the reading of the Q-RPT with no AutoZ offset ($P_{u,0}$) and the indication of the AutoZ reference ($P_{std,0}$) for gauge (G) or absolute measurement mode (A):

$$P_{offset} = P_{u,0} - P_{std,0}$$

P_{offset} represents the change in zero of the Q-RPT relative to the AutoZ standard ($P_{std,0}$). The AutoZ function manages the determination, storage and application of P_{offset} for PPCH system Q-RPTs in absolute and gauge measurement modes.

When the Q-RPT is calibrated, P_{offset} is set to zero. P_{offset} is then redetermined at regular intervals using the AutoZ function. The most recent value of P_{offset} is applied to the Q-RPT reading to correct for change in zero over time.

The AutoZ function can be turned ON and OFF. Table 11 summarizes the effect of AutoZ ON and OFF for PPCH Q-RPTs in different measurement modes.

AutoZ in absolute measurement mode

Q-RPTs with the designation Axxx are intrinsically absolute. They have an evacuated and sealed reference. Axxx Q-RPTs can measure absolute pressure (difference from vacuum). All PPCH Q-RPTs are of the Axxx type.

In absolute measurement mode, the source of $P_{std,0}$ must be an absolute pressure, nominally atmospheric pressure, with uncertainty significantly better than that of the Q-RPT that is being AutoZeroed. Given the high range of PPCH Q-RPTs, this is easily accomplished with a variety of digital barometers, including PPCH's on-board barometer (see Section 3.5.7.2).

When using an Axxx (absolute) Q-RPT in absolute measurement mode, with AutoZ ON, absolute pressure is calculated as:

$$P_{abs} = P_u - P_{offset,A}$$

In absolute measurement mode, execution of the AutoZ function to update the AutoZ value ($P_{offset,A}$), is initiated by the operator.

AutoZ in gauge measurement mode, dynamic compensation for atmospheric pressure

PPCH Q-RPTs are intrinsically absolute but they can also be used in gauge measurement mode (difference from atmosphere) (see Section 3.3.3, ○ PRINCIPLE). Gauge measurement mode is achieved by subtracting the value of atmospheric pressure from the Q-RPT's absolute reading using AutoZ and by dynamically compensating for changes in atmospheric pressure between opportunities for AutoZ to execute (see Section 3.2.4).

In gauge measurement mode, the value of $P_{std,0}$ is always zero gauge pressure. Zero gauge pressure, by definition, is applied to the Q-RPT when it is vented to atmosphere. In gauge measurement mode, the AutoZ routine is run automatically whenever the PPCH is in the vented condition. This assures regular automated updating of the $P_{offset,G}$ value corresponding to atmospheric pressure. Gauge pressure is the measured absolute pressure, P_u , minus $P_{offset,G}$.

$$P_{gauge} = P_u - P_{offset,G}$$

When AutoZ is ON, dynamic compensation for atmospheric pressure is also applied to compensate for changes in atmospheric pressure between AutoZ updates (see Section 3.2.4). The measured gauge pressure is calculated using ΔP_{atm} to correct the value of $P_{offset,G}$.

$$P_{gauge} = P_u - P_{offset,G} - \Delta P_{atm}$$

In gauge measurement mode, execution of the AutoZ function to update the value of $P_{atm,0}$, occurs automatically whenever PPCH is vented. Updating ΔP_{atm} occurs automatically continuously during unvented operation.



Take care to consider fluid heads in gauge mode operation. The fluid head when vented may be different from the fluid head at other pressures due to the height of the reservoir to which the Q-RPT is connected when vented (see Section 3.3.7, ○ PRINCIPLE).

AutoZ ON/OFF

The AutoZ function can be turned ON and OFF, separately for gauge and absolute measurement modes. Table 11 summarizes the effect of AutoZ ON and OFF for PPCH Q-RPTs in absolute and gauge measurement modes.

Table 11. AutoZ ON and OFF

MEASUREMENT MODE	AutoZ STATUS	P_{offset} APPLIED	ΔP_{atm} APPLIED	AutoZ ROUTINE RUNS
Absolute	ON	YES	Not Applicable	When initiated by operator
	OFF	NO		Not available
Gauge	ON	YES	YES	Automatically when PPCH in VENT condition
	OFF		NO	

Recommendations for the Use of the AutoZ Function

The AutoZ function provides a powerful and easy to use tool for improving the stability over time of PPCH internal and external Q-RPTs and maximizing the recalibration interval by compensating for change in zero between full recalibrations. The following simple recommendations will help assure that you use this feature to best advantage.

- In **gauge measurement** mode: Always leave AutoZ ON when operating.
- In **absolute measurement** mode: Always leave AutoZ ON when operating **if** the AutoZ routine has been run regularly using a valid Z_{offset} reference.
- In **absolute measurement** mode: Run AutoZ at least every 30 days or when RPM4 has been exposed to temperature changes exceeding 15 °C (36 °F).
- In **absolute measurement** mode: Run AutoZ only when a reference whose measurement uncertainty is known to be significantly better than that of the Q-RPT to be AutoZeroed is available. Keep range ratios in mind when comparing uncertainty. A ± 0.1 % FS barometer is roughly 100 times better than a ± 0.01 % 100 MPa (15 000 psi) Q-RPT because the Q-RPT/barometer pressure range ratio is 1000:1.
- In **absolute measurement** mode: Allow the PPCH to stabilize at atmospheric pressure and ambient temperature for 10 to 15 minutes before running AutoZ.
- In **absolute measurement** mode: Take care to properly consider fluid heads on the Q-RPTs and the AutoZ reference.

○ OPERATION



The AutoZ function and values are Q-RPT AND measurement mode (absolute, gauge) specific.



When AutoZ is run for an external Q-RPT in an RPM4, the PPCH causes the RPM4 to run its own AutoZero routine. The RPM4 Q-RPT is then AutoZeroed as if it had been AutoZeroed independently of the PPCH.

To access the PPCH AutoZ function menu press [**SPECIAL**], **<1AutoZ>**. The display is:

1. Active Q-RPT designator.
2. Indication of active measurement mode (**<abs>** for absolute, **<gage>** for gauge).
3. Indication of whether AutoZ is currently ON or OFF for this Q-RPT and measurement mode.

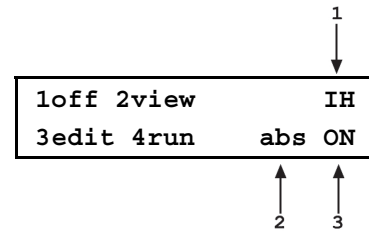

Select **<1off>** (or **<1on>**) to change the AutoZ status for the current Q-RPT and measurement mode from ON to OFF or vice versa.



AutoZ ON is indicated by a **<z>** in the MAIN RUN screen, top line, fourth character from the right. When AutoZ is OFF, the character is blank.

Select **<2view>** to view the current value of P_{offset} for the active Q-RPT and measurement mode.



P_{offset} should be zero for Axxx Q-RPTs when the PPCH is new or has just been calibrated. P_{offset} should be roughly equal to atmospheric pressure for a PPCH Q-RPT in gauge mode.

Select **<3edit>** to edit the value of P_{offset} for the active Q-RPT and measurement mode (see Section 3.5.1.1).



The value of P_{offset} is always displayed and entered in Pascal (Pa). Normally, in day to day operation, the value of P_{offset} is changed by running AutoZ (see Section 3.5.1.2), not direct editing.

Select **<4run>** to run the AutoZ routine which determines and activates P_{offset} relative to $P_{\text{std},0}$ (see Section 3.5.1.2). **<4run>** is only applicable to absolute measurement mode. AutoZ is run automatically without operator intervention in gauge measurement mode whenever PPCH is in the VENT condition (see Section 3.2.4).

3.5.1.1 EDIT AUTOZ



The edit AutoZ function should be used with great caution as entering inappropriate values and turning ON AutoZ may result in out of tolerance measurements. In normal day to day operation, the value of the AutoZ offset, P_{offset} , should be changed using the run AutoZ function (see Section 3.5.1.2) in absolute measurement mode or automatically in gauge modes.

Before editing P_{offset} , see Section 3.5.1, ○ PRINCIPLE.

To edit the current P_{offset} value for the active Q-RPT and measurement mode, press [SPECIAL], <1AutoZ>, <3edit>. The display is:

1. <Abs> for absolute, <Gage> for gauge.
2. Active Q-RPT for which P_{offset} is being viewed.
3. Edit field for value of P_{offset} .

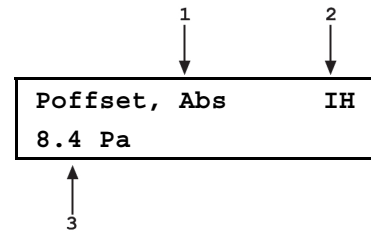

Edit P_{offset} as desired and press [ENT] to activate the new value. Press [ESC] to abandon changes.



The value of P_{offset} is always displayed and entered in Pascal (Pa).

3.5.1.2 RUN AUTOZ



Run AutoZ applies only to PPCH Q-RPTs in absolute measurement mode. In gauge measurement modes, AutoZ is run automatically whenever the PPCH is in the VENT condition.

Run AutoZ is the function by which the current RPT reading is compared to a reference, $P_{std,0}$, at atmospheric pressure to determine a new value of P_{offset} . The value of P_{offset} is then used by AutoZ to automatically correct the RPT for possible change in zero (see Section 3.5.1, ○ PRINCIPLE).



Allow the PPCH Q-RPT to stabilize at atmospheric pressure and ambient temperature for 10 to 15 minutes before running AutoZ. The stabilization period is not necessary for a utility sensor.

To access run AutoZ, press [SPECIAL], <1AutoZ>, <4run>.

If the current measurement mode is gauge, a message indicating that AutoZ cannot be run manually in gauge mode is displayed.

If the current measurement mode is absolute and a Q-RPT is active (not a utility sensor), the display is:

1. Real time reading (without head correction), pressure unit of measure and measurement mode of the active Q-RPT.
2. Active Q-RPT position designator.
3. Entry field for the value of $P_{std,0}$ in the current pressure unit of measure.

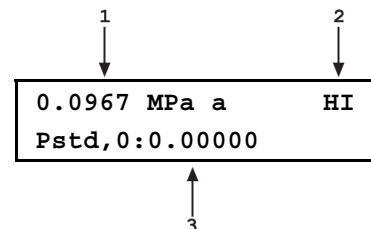

Enter the value of the AutoZ reference ($P_{std,0}$) in the same unit of measure as the top line display and press [ENT]. PPCH logs the readings and calculates a new AutoZ P_{offset} value. The next display is:

Press [ENT] to activate the new value of P_{offset} or [ESC] to start over with entry of a new AutoZ reference ($P_{std,0}$) value.

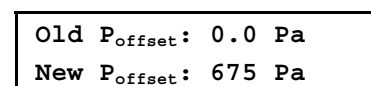



While the value of $P_{std,0}$ is entered in the current pressure unit of measure, the value of P_{offset} is always in Pascal (Pa).



If running AutoZ results in a value of P_{offset} that is greater than $\pm 0.01\%$ FS of the span of the Q-RPT that is being AutoZeroed, the Q-RPT and/or the reference used as the source of $P_{std,0}$ may be out of tolerance or the AutoZ process may have been faulty. Before activating a new P_{offset} greater than $\pm 0.01\%$ FS of the active Q-RPT, check to be sure that both the Q-RPT and the reference were in good working order, properly vented to stable atmospheric pressure, with the same fluid heads and reading in the same pressure units when AutoZ was run.



When running AutoZ, if a HEAD correction is currently active (see Section 3.3.7), it is momentarily disabled to avoid “zeroing out” the head value.

If the current measurement mode is absolute and a utility sensor is active (not a Q-RPT), the display is:

1. ActiveRPT designator.
2. Current measurement mode (absolute).
3. Selection of source of $P_{std,0}$ reference to which to AutoZ.

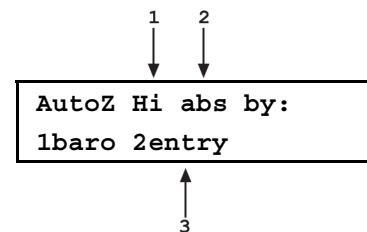

The default selection is **<1baro>**. With this selection, when AutoZ is ON, the PPCH on-board barometer (see Section 3.5.7.2) is used as the AutoZ reference ($P_{std,0}$) and AutoZ runs automatically whenever PPCH is vented. The AutoZ function should be ON with **<1baro>** selected unless there is a malfunction of the on-board barometer.

Select **<2entry>** to run AutoZ manually by entering the value of AutoZ reference ($P_{std,0}$) as described in “**If the current measurement mode is absolute and a Q-RPT is active**” above.

3.5.2 <2REMOTE>

○ PURPOSE

To configure the PPCH COM1, COM2 and IEEE-488 (GPIB) communication ports. To test COM1 and COM2 communications. To select remote programming communications format.

○ PRINCIPLE

The PPCH has two RS-232 communications ports referred to as COM1 and COM2 and a single IEEE-488 (GPIB) port. COM1 or the IEEE-488 port is for communicating with a host computer (see Section 4), and COM2 is reserved for communicating with an external device (i.e. an RPM4, a multimeter, etc.). These ports' settings can be viewed and changed using **[SPECIAL], <2remote>**.

PPCH has two remote communications formats, classic and enhanced. Which of these is active can be selected.

A self test is supplied for RS-232 communications. The self test allows verification that the PPCH RS232 ports (COM1 and COM2) are operating properly and that a valid interface cable is being used.

○ OPERATION

To access the communications settings, press **[SPECIAL]**, **<2Remote>**.

Choice include:

- <1COM1>** To view and edit COM1 settings (see Section 3.5.2.1.).
- <2COM2>** To view and edit COM2 settings (see Section 3.5.2.1.).
- <3IEEE>** To view and edit IEEE-488 settings (see Section 3.5.2.2.).
- <4format>** To select remote programming command format (see Section 3.5.2.3.).
- <5RS232test>** To run the COM1 and COM2 communications test (see Section 3.5.2.4.).

3.5.2.1 <1COM1, 2COM2>

The COMx ports can be set for specific communications settings. The settings are baud rate, parity, data bits and stop bits. The available options are:

Baud	300, 600, 1 200, 2 400, 4 800, 9 600, 19 200, 28 800, 38 400
Parity	NONE, ODD or EVEN
Length	7 or 8
Stop Bit	1 or 2

The default is <2 400, E, 7,1> for both COM1 and COM2.

The user can also specify one or two termination characters as well as define these characters. These are referred to as “Term1” and “Term2”. These define the characters that mark the end of commands that are sent to the PPCH. The PPCH looks for an ASCII(13) (carriage return) to terminate a received command but responds with both and ASCII(13) (carriage return) and an ASCII(10) (line feed). There are no other options.

3.5.2.2 <3IEEE-488>

The IEEE-488 port's primary address can be set from 1 to 31 in this screen. The factory default value is 10. Secondary addressing is not used or supported. This address must not conflict with the address of any other device on the same IEEE-488 bus.

The receiving terminating character must be a line feed and EOI. Carriage returns are ignored if received. The PPCH sends a line feed and asserts the EOI line to terminate a reply. These settings are fixed to agree with IEEE Std. 488.2. If you change the address, the IEEE interface will reset (PON) and become idle.

3.5.2.3 <4FORMAT>

The PPCH has two different syntax formats available for the remote program commands. The **classic** format is compatible with previous PPC products and is the default format. The **enhanced** format follows the syntax, format, and status reporting features of IEEE Std 488.2. The details of each are covered in Section 4.3.

[SPECIAL], **<2remote>**, **<4format>** allows the remote program command syntax to be selected. The cursor is on the active format. Select **<1classic>** to activate the classic command format or **<2enhanced>** for the enhanced format.

Selecting a format resets the IEEE-488 interface and puts it into an idle state.

3.5.2.4 <5RS232 SELF-TEST>

The RS232 self-test is provided to check the PPCH COM ports and the interface cable independently of an external device or computer.

If you are having difficulty communicating with PPCH from a host computer using RS232, the RS232 self test can help establish that the PPCH COM1 port you are trying to communicate with and the interface cable you are using are good.

To run a self test of the RS232 ports (COM1 and COM2), press **[SPECIAL]**, **<2remote>**, **<5RS232test>**.

The display prompts you to connect COM1 to COM2 using a standard pin-to-pin DB-9F to DB-9M RS232 cable (see Section 4.2.1.1).

Once the cable has been installed, press **[ENT]** to run the self-test. The test is first executed in the COM1→COM2 direction and then in the COM2→COM1 direction.

If the COM1→COM2 test passes: **<PASSED>** displays briefly and the test proceeds to COM2→COM1.

If COM2→COM1 passes: **<PASSED>** is displayed briefly followed by the conclusion, **<The RS232 test has PASSED>**.

If a test fails: Execution is suspended until **[ENT]** is pressed.



The PPCH RS232 test can fail for three reasons:

1. The RS232 cable being used is incorrect (see Section 4.2.1.1 for information on the correct cable).
2. COM1 and COM2 do NOT have the same serial communications settings and therefore cannot communicate together (see Section 3.5.2.1 to set the COM ports).
3. COM1 or COM2 is defective.

The reason for failed communications is almost always a cable or incorrect RS232 interface settings. Be sure that these are correct before concluding that a COM port is defective.

3.5.3 <3HEAD>

○ PURPOSE

To view or change the properties of the HEAD function (see Section 3.3.7) including the unit of measure of length for head height entry and the test fluid type and species for density calculations.

○ OPERATION

From the MAIN RUN screen, press **[SPECIAL]**, **<3Head>**.

Select the desired height unit of measure and press **[ENT]**.

Select **<1gas>** or **<2liquid>** depending on the pressurized medium between the PPCH and the height at which pressure is to be calculated. Select the gas or liquid species. The liquid selection **<3User>**, is to create a custom liquid with a user entered density.

Use **[HEAD]** to set a fluid head height if desired (see Section 3.3.7).

3.5.4 <4RESET>

○ PURPOSE

To reset various PPCH settings to default or factory values.

○ PRINCIPLE

PPCH stores its user definable settings in non-volatile memory. The reset menu allows the user to selectively or completely reset these settings to factory defaults. This clears out any settings that the user has made, and should be used only to restore the PPCH to a known state. PPCH goes through its power up sequence after any type of reset is executed.



PPCH reset functions will change current settings to factory defaults. These may include settings vital to PPCH operation and affecting the calibration of the quartz reference pressure transducers (Q-RPTs). Reset functions should only be used by qualified personnel with knowledge of reset consequences. Reset functions should not be used experimentally.

○ OPERATION

To access the RESET menu, press **[SPECIAL]**, **<4reset>**. The display is:

1sets 2units 3ATest
4cal 5all

RESET menu choices include:

- <1set>** to reset general system operating parameters (see Section 3.5.4.1).
- <2units>** to reset unit of measure functions (see Section 3.5.4.2).
- <3ATest>** to reset AutoTest parameters and clear the AutoTest data log (see Section 3.5.4.3).
- <4cal>** to reset internal calibration coefficients and modes (see Section 3.5.4.4).
- <5all>** to reset all settings except ID and security password to factory default values (see Section 3.5.4.5).

3.5.4.1 <1SETS>

○ PURPOSE

Sets most general operating parameters back to default values. Does not affect calibration coefficients, remote interfaces or AutoRange ranges. The Reset – Sets resets are itemized in Table 12.

Table 12. Reset – Sets

RESET	RESULT	SEE SECTION
[UNIT]	Returns pressure unit of measure to first of six available.	3.3.2
[MODE]	Returns measurement mode to the natural Q-RPT mode.	3.3.3
[RANGE]	Hi Q-RPT or utility sensor default range.	3.3.1
[HEAD]	0 cm height and Nitrogen medium.	3.3.7
Control Mode	Dynamic, standard	3.4.6
Control Limits	Default values of Hi RPT default range.	3.4.6.1
Upper Limit	Default value of Hi RPT default range.	3.4.4
Resolution	0.001% FS of Hi RPT default range.	3.4.2
AutoZ	AutoZ ON. Z _{offset} value not affected.	3.5.1
Leak Check	15 second run time	3.3.9
Screen Saver	10 minutes to activation.	3.5.5.1
Key Sounds	Medium	3.5.5.2
Volume Determination	Return to default	3.5.7.1

3.5.4.2 <2UNITS>

○ PURPOSE

Sets the six pressure units available under the UNIT function to the SI or US default selections depending on whether the PPCH has been factory set for SI or US (see Section 3.3.2).

Sets the user defined unit to 1.000/Pa (see Section 3.5.6).

3.5.4.3 <3ATEST>

○ PURPOSE

- Resets Quick Test and Q-DUT Tests to default (see Section 3.3.6).
- Clears AutoTest data log (see Section 3.4.5).

3.5.4.4 <4CAL>

○ PURPOSE

 *The Reset - Cal function will reset Q-RPT, utility sensor and barometer calibration coefficients and settings and reset AutoZ values to zero. This will change the PPCH calibration and could cause it to make out of tolerance measurements.*

Clears all user values affecting the calibration of Q-RPTs, utility sensor and the on-board barometer. Does not clear factory coefficients. The Reset – Cal resets are itemized in Table 13.

Table 13. Reset – Cal

RESET	RESULT	SEE SECTION
All Q-RPT user calibration coefficients	PA to zero, PM to 1.	5.3.1.1, 5.3.7
Q-RPT absolute mode	ON.	5.3.5
Utility Sensor calibration coefficients	PA to zero, PM to 1.	5.5
On-board barometer calibration coefficients	PA to zero, PM to 1.	5.4
Calibration date	Set all dates to 19800101.	5.3.7, 5.5, 5.4
AutoZ values	All P _{offset} values to zero for absolute mode and 101325 Pa for gauge modes.	3.5.1
AutoZ function	ON, all Q-RPTs, all measurement modes.	3.5.1

3.5.4.5 <5ALL>

○ PURPOSE

 *The reset - all function clears and deletes large amounts of user defined information including critical calibration data.*

Combines all resets in one global reset command that clears the entire user section of non-volatile memory returning PPCH to the “as delivered” condition except the ID function (see Section 3.5.5.4) and the security level password (see Section 3.5.5.5). The Reset – All resets are itemized in Table 14.

Table 14. Reset – All

RESET	RESULT	SEE SECTION
Reset – Sets	All the resets of Reset – Sets	3.5.4.1
Reset – Units	All the resets of Reset – Units	3.5.4.2
Reset – Atest	All the resets of Reset – Atest	3.5.4.3
Reset – Cal	All the resets of Reset – Cal	3.5.4.4
Remote Interfaces	COM1, COM2 and IEEE-R88 interfaces to default settings.	3.5.2
Remote Communications	Remote command format to Classic.	3.5.2.3
Level (Security)	Low.	3.5.5.5
Valve Config	Return to factory valve opening points to factory values.	3.5.7.1

3.5.5 <5PREF>

○ PURPOSE

To access a menu of PPCH operational preferences and functions.

○ OPERATION

To access the PREF menu press **[SPECIAL]**, <5pref>. The display is:

1ScrSvr 2sound 3time 4ID 5level

The PREF menu includes:

- <1ScrSvr>** View and change the screen saver activation time (see Section 3.5.5.1).
- <2sound>** View and change the key press sounds (see Section 3.5.5.2).
- <3time>** View and edit the internal time and date settings (see Section 3.5.5.3).
- <4ID>** View the RPM3 serial number (SN) and view or edit the ID number (see Section 3.5.5.4).
- <5level>** View and set user security level and password (see Section 3.5.5.5).

3.5.5.1 <1SCRSVR>

○ PURPOSE

To adjust the idle time after which PPCH's SCREEN SAVER activates.

○ PRINCIPLE

PPCH has a SCREEN SAVER function which causes the display to dim after a front panel key is NOT pressed for a certain amount of time. The default screen saver time activates the screen saver after 10 minutes. The screen saver activation time can be adjusted by the user or screen saving can be completely eliminated.



Setting screen saver time to zero eliminates the SCREEN SAVER function so that the display permanently remains at full brightness.

○ OPERATION

To access the SCREEN SAVER function, press **[SPECIAL]**, **<5pref>**, **<1ScrSav>**. Edit, in minutes, the idle time after which screen saver will activate to dim the screen. Set the time to zero to eliminate the SCREEN SAVER function.

3.5.5.2 <2SOUND>

○ PURPOSE

To adjust or suppress the PPCH valid key press sound.

○ PRINCIPLE

PPCH provides audible feedback by a brief “beep” when a valid key press is made. The tone frequency of this beep may be selected from three choices or it may be completely suppressed. Invalid key presses are indicated by a descending two tone “blurb” which cannot be suppressed.

○ OPERATION

To access the keypad sound adjustment function press **[SPECIAL]**, **<5pref>**, **<2sound>**.

Select between **<2lo>**, **<3mid>** or **<4hi>** to adjust the valid key press tone frequency.

Select **<1none>** to suppress the valid key press tone.



The sound function only affects the valid key press tone. The invalid key press and other tones cannot be suppressed. See Section 3.1.5 for a complete listing of PPCH sounds.

3.5.5.3 <3TIME>

○ PURPOSE

To view and edit the PPCH internal time and date settings.

○ OPERATION

To access the TIME function press **[SPECIAL]**, **<5pref>**, **<3time>**.
The display is:

Edit: 1time 2date
08:32:11 am 20020925

Select **<1time>** to edit the time. Edit hours, then minutes, then am/pm by pressing **[ENT]** after each entry. Seconds go to zero when minutes are entered. This can be used to synchronize the time with a time standard.

Select **<2date>** to edit the date. The date must be specified in YYYYMMDD format.



The PPCH date and time are set to United States Mountain Standard Time in the final test and inspection process at the factory. If desired, use the TIME and DATE functions to set your local time and date.

3.5.5.4 <4ID>

○ PURPOSE

To view or edit the PPCH user ID and to view the PPCH serial number.

○ OPERATION

To access the ID function press **[SPECIAL]** and select **<5pref>**, **<2ID>**. Select **<1view>** to view the current ID.

Select **<2edit>** to edit the ID.

The ID has twelve characters. When the edit screen is opened, the cursor is on the first character. Numerical values can be entered directly from the keypad. In addition, the cursor control keys can be used to toggle through a list of available alpha numeric characters. Holding the key slews through the characters. Character order going up is: blank space, symbols, lower case letters, upper case letters, numbers. After selecting a character, press **[ENT]** to activate it and move to the next character field.

When a character is selected the cursor moves to the next character. To leave a blank character, press **[ENT]** with the field for that character blank. Use this for the trailing characters if the ID being entered is less than twelve characters.

After the last of the twelve characters has been entered, the **<Save ID?>** option is offered. Select **<1no>** to return to the ID edit screen. Select **<2yes>** to save the edited ID.



The ID can be set remotely from a computer which is quite a bit more convenient than entering characters from the keyboard (see Section 4.4, ID command). The ID is not cleared or reset by any RESET function (see Section 3.5.4).

3.5.5.5 <5LEVEL> (SECURITY)

○ PURPOSE

To set user protection levels to restrict access to certain functions and to edit the password required for changing user levels.

○ PRINCIPLE

PPCH's front panel user interface provides the means to access all PPCH user defined data, settings and functions including calibration data. Inadvertent, uninformed or unauthorized altering or deleting of data, settings and functions could require extensive reconfiguration by the user and might cause invalid readings and behavior. For these reasons, depending upon the application in which PPCH is being used, it may be desirable to restrict access to certain functions for certain users. The user level function provides a means of restricting access to certain functions. Four different levels of security are available.

Access to changing security levels can be left open, or be protected by a password.

Security Levels

The security levels are structured to support typical operating environments as follows:

- | | |
|---------------|---|
| None | This level is intended for use only by the system manager and/or calibration facility. It allows access and editing in all areas including critical metrological information. |
| Low | Low security is designed to protect the specific metrological information and SYSTEM DIAGNOSTIC AND MAINTENANCE functions of the system against accidental alteration. It is intended for an advanced operator performing many different tasks. Low security is the default user level setting. |
| Medium | Medium security is designed to protect specific metrological information in the system and to assure that the PPCH is operated using consistent operational parameters. |
| High | High security is designed to protect all operating parameters. It is intended to minimize operator choices, for example to perform repeated identical calibrations under consistent conditions. |



PPCH is delivered with the security level set at low to avoid inadvertent altering of critical internal settings but with access to changing security levels unrestricted. It is recommended that the low security level be maintained at all times. If there is a risk of unauthorized changing of the security level, changing authority should be password protected (see ○ OPERATION of this section).

The security levels are structured to support typical levels of operation as shown in Table 15. Specifically, the security levels prevent execution of the functions accessed by the key strokes marked by “•”:

Table 15. Security levels

FUNCTION	LOW	MEDIUM	HIGH
[RANGE]			•
[UNIT]			•
[MODE]			•
[AutoRange]		•	•
[RPT]		•	•
[AutoTest], <2QDUT>			•
[AutoTest], <1Quick>, <Run current Quick ATest: 2no>			•
[HEAD]			•
[PRIME]			•
[LEAK CK]			•
[SETUP]			•
[SETUP], <1range>		•	•
[SETUP], <2res>		•	•
[SETUP], <4UL>		•	•
[SETUP], <6control>		•	•
[SETUP], <7drv>		•	•
[SPECIAL]			•
[SPECIAL], <1AutoZ>		•	•
[SPECIAL], <1AutoZ>, <1on/1off>	•	•	•
[SPECIAL], <1AutoZ>, <3edit>	•	•	•
[SPECIAL], <2remote>			•
[SPECIAL], <2remote>, make changes		•	•
[SPECIAL], <3head>		•	•
[SPECIAL], <4reset>		•	•
[SPECIAL], <4reset>, <4cal>	•	•	•
[SPECIAL], <4reset>, <5all>	•	•	•
[SPECIAL], <5pref>, <1ScrSvr>		•	•
[SPECIAL], <5pref>, <2sound>		•	•
[SPECIAL], <5pref>, <3time>		•	•
[SPECIAL], <5pref>, <3time>, make changes	•	•	•
[SPECIAL], <5pref>, <4ID>, <2edit>	•	•	•
[SPECIAL], <6Punit>		•	•
[SPECIAL], <7internal>		•	•
[SPECIAL], <7internal>, <1config>, <1volume>			•
[SPECIAL], <7internal>, <1config>, <2valve>		•	•
[SPECIAL], <8cal>		•	•
[SPECIAL], <8cal>, <2edit> under any selection	•	•	•
[SPECIAL], <9log>, view			•
[SPECIAL], <9log>, clear log	•	•	•
Remote communications disabled			•

“•” indicates the function/menu is NOT accessible.

○ OPERATION

PPCH is delivered with no active password and access to the User Level menu is open. The user level is set to **<1Low>**. User levels can be changed freely until a password has been created.

To access the LEVEL function press **[SPECIAL]**, **<5pref>**, **<5level>**. The display is:

```
1change user level
2edit password
```

Selecting **<1change user level>** brings up the restriction menu:

```
Restrictions: 1none
2low 3medium 4high
```

The cursor is on the current restriction level. Select a different level or or **[ESC]** back to the MAIN RUN screen.

If no password is active, selecting **<2edit password>** displays the user password and allows it to be edited.

```
Password: pppppp
0 disables password
```



Once a password has been entered, the user level cannot be changed without reentering the password.

Passwords can be up to six numbers in length and cannot start with a zero. If **<0>** is entered, the password is made inactive and the user will not be required to enter a password to access the user level menu. This condition, with a security level of **<2low>**, is the factory default.

If there is an active password, the PPCH password entry screen appears. The user must enter the user defined password or the factory secondary password to proceed further:

```
PPCH SNnnnn-xx
Password: pppppp
```

The first field, **<nnnn>**, is the serial number of the PPCH, followed by a second field, **<xx>**, that represents the number of times that a secondary password has been used. The second field, **<xx>**, increments each time a secondary password is used. The third field, **<pppppp>** is for user entry of the normal password.



The factory secondary password is available in case the user's password has been misplaced or forgotten. It can be obtained by contacting a DHI Authorized Service Center (see Table 31). The factory secondary password is different for all PPCH's and changes each time it is used.

3.5.6 <6PUNIT>

○ PURPOSE

To customize the selection of pressure units of measure that are available in the **[UNIT]** key menu.

○ PRINCIPLE

The [UNIT] function key makes available a choice of six default pressure units (US or SI units depending on whether the PPCH has been factory set as US or SI) (see Section 3.3.2). PPCH also supports many commonly used units other than those included in the default set up. These units can be made available for active selection by customizing the UNIT function using [SPECIAL], <6PresU>. This allows PPCH to offer a very wide selection of units while simplifying day to day operation. The typical user customizes the [UNIT] function key to support his/her six most commonly used units.

○ OPERATION

To customize the [UNIT] function key, from the MAIN RUN screen press [SPECIAL], <6PresU>. The display is:

1. Entry field to specify which unit position (1 – 6) of the [UNIT] function key menu is to be changed.

Set up unit #6

Enter the number of the unit position that you would like to change. The display becomes:

Unit#6
 1SI 2other 3user

Select the desired pressure unit category (SI units include units based on SI such as mmHg), then select the desired unit from the unit menu.

The units of measure available are listed in Table 16.

Table 16. UNIT function - available units of measure

<1SI>	<2OTHER>	<3USER>
<1Pa>	<1psi>	
<2hPa>	<2psf>	
<3kPa>	<3inHg>	
<4MPa>	<4inWa>	
<5mbar>	<5kcm2>	
<6bar>	<6Torr>	
<7mmHg>	<7mTor>	
<8mmWa>		

If <3user> is selected, the user unit must be defined. The display is:

1. Entry field.

Define user unit:
 1.000000 unit/Pa

Enter the number of user units per Pascal (Pa) in the entry field. Pressing [ENT] defines the user unit and returns to the <Set up unit #n> screen.

The user defined unit label can be customized to any alphanumeric, four character label using the remote command "UDU" (see Section 4.4).

See Section 7.2.1 for the pressure unit conversion factors used by PPCH.

3.5.7 <7INTERNAL>

○ PURPOSE

To view, set, adjust, and maintain various aspects of PPCH's internal operation.

○ OPERATION

To access the internal selections press **[SPECIAL]**, **<7internal>**. The display is:

1config 2baro
3pump

The INTERNAL menu choices include:

- <1config>** To run automated routines that readjust PPCH internal pressure control coefficients and determine the test volume to which the PPCH is connected (see Section 3.5.7.1).
- <2baro>** View the real time output of the on-board barometer (see Section 3.5.7.2).
- <3pump>** Run an automated pump priming routine, view the status of the pump supply reservoir level switch, view the reading of the pump output pressure transducer (see Section 3.5.7.3).

3.5.7.1 <1CONFIG>

○ PURPOSE

To run automated routines that determine control valve opening coefficients and the test volume to which PPCH is connected.

○ PRINCIPLE AND OPERATION

These functions are considered part of PPCH maintenance and are therefore covered in the maintenance section of this manual (see Sections 5.7, 5.8).

3.5.7.2 <2BARO>

○ PURPOSE

To view the value of atmospheric pressure as measured by the PPCH on-board barometer.

○ PRINCIPLE

PPCH is equipped with an on-board barometer. The atmospheric pressure measurements made by the on-board barometer are used for dynamic compensation of atmospheric pressure when using an Axxx Q-RPT to make gauge pressure measurements (see Sections 3.3.3, ○ PRINCIPLE and 3.2.4). The barometer, if calibrated, may also be used as a reference for AutoZ of Q-RPTs in absolute measurement mode (see Section 3.5.1).



The on-board barometer is a low accuracy sensor used only for measuring small changes in atmospheric pressure over short periods of time (see Section 3.2.4) PPCH measurement uncertainty does not depend on the measurement uncertainty of the on-board barometer unless the barometer is used as a reference for AutoZ of Q-RPTs in absolute measurement mode.

○ OPERATION

To view the current reading of the on-board barometer press **[SPECIAL]**, **<7internal>**, **<2baro>**. The display is in the active pressure unit of measure (see Section 3.3.2).

3.5.7.3 <3PUMP>

○ PURPOSE

To access special functions associated with the PPCH hydropneumatic pump and reservoir.

○ OPERATION

To access the pump functions menu press **[SPECIAL]**, **<7internal>**, **<3pump>**.

The PUMP menu choices include:

- <1prime>** To run an automated routine to prime the PPCH's on-board hydropneumatic pump when it has pumped air instead of liquid. (see Section 5.10.1).
- <2level>** To view the status of the internal fluid reservoir level switch and set the action to take when a low level is detected (see Section 3.5.7.3.2).
- <3pressure>** To view the pressure measured by the pump drive pressure transducer and the calculated pump fluid output pressure (see Section 3.5.7.3.3).
- <4hours>** To view a timer of the number of hours the PPCH's on-board hydropneumatic pump has been in operation and to reset the timer if desired (see Section 3.5.7.3.4).

3.5.7.3.1 <1PRIME>

○ PURPOSE

To run an automated routine to prime the PPCH's on-board hydropneumatic pump when it has pumped air instead of liquid.

○ PRINCIPLE AND OPERATION

This function is considered part of PPCH maintenance and are therefore covered in the maintenance section of this manual (see Section 5.10.1).

3.5.7.3.2 <2LEVEL>

○ PURPOSE

To view the status of the internal fluid reservoir level switch and to specify what PPCH should do when low reservoir is indicated.

○ PRINCIPLE

PPCH has an internal fluid reservoir (see Section 2.3.6). The reservoir is equipped with a level switch to provide a warning when the level of the fluid in the reservoir is low. When the level switch detects a low level in the reservoir, a warning is provided on the PPCH front panel. The status of the switch can also be determined by remote command or using **[SPECIAL]**, **<7internal>**, **<3pump>**, **<2level>**, **<1view>**.

By default, when a low reservoir condition is detected, PPCH aborts pressure control and will not accept any local or remote commands to adjust pressure. Pressure control is prevented to protect the PPCH hydropneumatic pump which

can be damaged by running dry. This condition is cleared when the reservoir is filled and the level switch no longer indicates low. PPCH can be set so that pressure control is not prevented when a low reservoir is detected. This is done using **[SPECIAL]**, **<7internal>**, **<3pump>**, **<2level>**, **<2low action>**.

○ OPERATION

To view the status of the PPCH internal reservoir level switch, press **[SPECIAL]**, **<7internal>**, **<3pump>**, **<2level>**, **<1view>**.

<OK> indicates that the fluid level is NOT low. **<LOW>** indicates a low fluid level.

To view or set the low reservoir action, press **[SPECIAL]**, **<7internal>**, **<3pump>**, **<2level>**, **<1low action>**. The cursor is on the current setting. Select **<1abort>** to cause pressure control to be aborted when a low reservoir condition is detected and no further pressure commands to be accepted until the reservoir is filled. Select **<2none>** for the no special action to be taken when a low reservoir condition is detected (the audible and display low level alarms are still active).



The default low reservoir action is <1abort> which prevents pressure control. This is to protect the PPCH's pump from running dry which may damage it. PPCHs that run unattended should always be set to the <1abort> default condition

3.5.7.3.3 <3PRESSURE>

○ PURPOSE

To view the pressure measured by the pump drive pressure transducer and the calculated pump fluid output pressure.

○ PRINCIPLE

PPCH has an internal hydropneumatic pump to generate high liquid pressure. The pump is driven by pneumatic pressure (see Section 3.2.1 and Figure 9). The pneumatic pressure is read by a transducer and the pump output is calculated from the drive pressure using the pump ratio. The calculated pump output pressure is used by PPCH in its pressure control logic. Viewing the value of the pump drive pressure can also be useful in troubleshooting PPCH operation.



The hydropneumatic pump drive pressure is regulated by a regulator internal to PPCH (see Section 3.2.1, Figure 9). It is normal for the indicated pump drive pressure to be lower than the pressure supplied to the PPCH rear panel.

○ OPERATION

To view the pressure measured by the pump drive pressure transducer and the calculated pump liquid output pressure, press **[SPECIAL]**, **<7internal>**, **<3pump>**, **<3pressure>**. The **<Pump drive>** is always in kPa and the **<Output>** is in MPa.

Pump Drive Pressure and Output Pressure Values

The pump output pressure is calculated using the pump drive pressure and the pump ratio. The required drive pressure, is the drive pressure needed to achieve the required pump output pressure for a given PPCH model.

Required pump output by PPCH model is:

PPCH-70M:	84 MPa
PPCH-100M:	120 MPa
PPCH-140M:	168 MPa
PPCH-200M:	230 MPa

3.5.7.3.4 <4HOURS>

○ PURPOSE

To view a timer of the hours of operation of the PPCH internal hydropneumatic pump and reset the timer if desired.

○ PRINCIPLE

PPCH has an internal hydropneumatic pump to generate high liquid pressure. The seals require regular maintenance. Recommended maintenance is every 2000 hours of pressurized operation. The pump is pressurized when gas drive pressure is applied to it. Gas drive pressure is applied to the pump whenever the PPCH is powered ON, and its condition is other than vented (**VENT** LED on). The hours PPCH spends with its pump operating (pump drive air supply valve open) are accumulated by the pump timer.

The pump timer can be reset to zero by the operator. Normally, the time is reset to zero when the pump is serviced or replaced (see Section 5.10).

○ OPERATION

To view the pump timer, press [**SPECIAL**], <7**internal**>, <3**pump**>, <4**hours**>. The hours of pump operation (pump drive air supply valve open) since the last reset are displayed.

To reset the pump timer to zero, press [**SPECIAL**], <7**internal**>, <3**pump**>, <4**hours**>, <1**reset**>. A confirmation menu is presented. Select <1**yes**> to reset the timer.

3.5.8 <8CAL>

○ PURPOSE

To calibrate the PPCH utility sensor, Hi and/or Lo Q-RPTs and adjust the on-board barometer. This function is considered part of PPCH maintenance and is therefore covered in the maintenance section of this manual (see Sections 5.2, 5.4, 5.5).

○ PRINCIPLE AND OPERATION

This function is considered part of PPCH maintenance and is therefore covered in the maintenance section of this manual (see Sections 5.2, 5.4, 5.5).

3.5.9 <9LOG>

○ PURPOSE

To view and/or clear the PPCH event log.

○ PRINCIPLE

PPCH records to a log each time one of the following events occurs:

- Pmax! of an internal PPCH Q-RPT or utility sensor is exceeded (see Section 3.4.4.1).
- A memory fault occurs.



Over pressure events on external Q-RPTs are not logged on the PPCH. They are logged in the 5.5RPM4's log (see the RPM4 Operation and Maintenance Manual).

○ OPERATION

To view the event log press **[SPECIAL]**, **<9Log>**.

Use **[◀]** and **[▶]** to move back and forth between older and newer log entries.

Each log entry has two screens, one with the event description and one with the even time and date. Use **[▲]** and **[▼]** to toggle between the two screens. The oldest logged event appears.

After the last log has been viewed, the option to clear the log, **<1no>**, **<2yes>** is presented. Use **<2yes>** to remove all entries from the log. Use **<1no>** to continue without altering the log.

To leave the log, use **[ESC]**.

NOTES

4. REMOTE OPERATION

4.1 OVERVIEW

Most of the PPCH front panel functions can also be executed by commands from a remote computer. The host computer can communicate to the PPCH using the PPCH COM1 RS232 port or the IEEE-488 port.

Before writing test code, which makes use of PPCH remote commands, familiarize yourself with its operating principles by reading Section 3 of this manual.

4.2 INTERFACING

Sending a program message to the PPCH places it into **remote** mode. The remote indicator to the right of the display window lights when the PPCH is in **remote** mode. It will also flicker when a program message is received. The menus usually accessed from the front panel are locked out while in remote. The **[ESC]** key returns the PPCH to local operation unless the **<REMOTE>** program message, which locks out all keypad operation, was sent to the unit. Going from remote to local or from local to remote aborts any active generation.

4.2.1 RS232 INTERFACE

4.2.1.1 COM1

The PPCH COM1 RS232 interface is located on the back of the unit. It is a 9-pin male DB-9F connector configured as a DCE device. Data is transmitted out of the unit using pin 2, and is received on pin 3. This allows a normal pin-to-pin DB-9M to DB-9F RS232 cable to be used to connect to a DTE host.

Handshaking is not required or supported. The COM1 receive buffer is 80 bytes deep. If you overflow the buffer by sending too much data, the data will be lost. Because of this, you **must** send a single program message at a time and you **must** wait for the PPCH to reply from the previous command before issuing another command.

Table 17. COM1 pin designations and connections

PPCH COM1 DB-9F PIN DESIGNATIONS		
PIN #	FUNCTION	DESCRIPTION
2	TxD	This pin transmits serial data from the PPCH to the host.
3	RxD	This pin accepts serial data from the host computer.
5	Grn	This pin is the common return for the TxD and RxD signals.

IBM PC/XT DB-9F CONNECTIONS		IBM PC/XT DB-9M TO PPCH DB9F CONNECTION	
DB-25M	DB-9F	DB-9M	DB-9F
2	3	3	3
3	2	2	2
7	5	5	5

4.2.1.2 IEEE-488

The PPCH IEEE-488 interface is located on the back of the unit. The physical and electrical interface conforms to IEEE Std 488.1-1987 Subset E2 and IEEE Std. 488.2-1992. You should not attempt to communicate with the IEEE-488 interface while using the COM1 interface. The IEEE-488 receive buffer is 250 bytes deep. If you attempt to overflow the buffer, the PPCH will hold off release of the NRFD handshake line until it can service and empty the receive buffer. This keeps the buffer from overflowing. It is recommended that you use the query form for all remote commands and wait for a reply to each command to ensue proper operation and order of command execution. If you choose not to use the query form for each command, it is recommended that you periodically check the error queue for command errors.

4.2.1.3 COM2

The PPCH COM2 RS232 interface is located on the back of the unit. Its most common use is to connect to **DHI** RPM4 reference pressure monitors to PPCH to add external measurement devices to the PPCH system (see Section 3.2.5)

COM2 can be used to allow the host computer to communicate with another device through the PPCH. This allows the user to use one host COM port to communicate with the PPCH and an additional RS232 device. Refer to the “#” and “**PASSTHRU**” remote program commands for details.

COM2 is a 9-pin female DB-9F connector configured as a DTE device. Data is transmitted out of the unit using pin 3, and is received on pin 2. This allows a normal pin-to-pin DB-9M to DB-9F RS232 cable to be used to connect to a DCE device.

Handshaking is not required or supported.

Table 18. COM2 DB-9F pin designations

PIN #	FUNCTION	DESCRIPTION
2	RxD	This pin transmits serial data from the PPCH to a device.
3	TxD	This pin accepts serial data from the external device.
4	DTR	This pin is Data Terminal Ready (DTR) (held at + 5 V).
5	Gm	This pin is the common return for the TxD and RxD signals.

4.3 PROGRAMMING FORMATS

PPCH supports two program message formats, the “classic” and “enhanced” formats. The user must select which format to use. Selection can be accomplished from the front panel (see Section 3.5.2.3) or remotely using the “**MSGFMT**” program message (see Section 4.4.3).

The main difference between the two formats is that when using the IEEE-488 interface, a “?” must be included in an enhanced command for there to be a response from the PPCH. In all other cases (classic or enhanced), every command has a response. In addition, the enhanced message format supports IEEE Std 488.2 syntax, format and status reporting.

The default is the classic format to allow downward compatibility with existing host software. **Classic mode is strongly suggested if the Std. 488.2 status system is not used.**

In either format, it is recommended that you start out a command sequence with the “***CLS**” command, which clears all of the communication and error queues. The basic commands are similar for both the classic and enhanced formats, but the usage, syntax, format and status reporting are different.



The PPCH program message set is compatible with the PPC3 program message set. Some PPC3 commands are not fully supported due to functional differences between PPCH and the PPC3 and PPCH includes some commands specific to PPCH hardware that PPC3 does not support.

4.3.1 CLASSIC PROGRAM MESSAGE FORMAT



The classic program message format is compatible with the PPC3 program message set. However, several PPC3 functions are not supported by PPCH and neither are their corresponding commands (these include “AUTOVAC”, “AUTOPURGE”, “CONFIG”, “NVENT”, “VAC”, “TOUT”, and “VALVE”). The classic format is recommended if you need downward compatibility with older DHI controllers or if you are not going to use the IEEE 488.2 status system.

Each program message sent is also a query. You can only send one program message to the PPCH at time. After sending any program message, you must wait for the PPCH to reply before sending another program message. This reply will contain data, or a numeric error message if the program message was invalid. You must wait for this reply before issuing another program message to the PPCH. This insures that the PPCH has completed the program message. Most remote program messages will return a reply within 500 ms except:

“PR”, “PRR”, “SR”, “ATM”, “RATE”: 2 seconds to allow a new measurement.

“RPT”, “ARANGE”: Up to 10 seconds

The syntax and format used for each program message in the classic mode is listed next to the keyword ‘Classic:’ in each program message summary in Section 4.4.4.

4.3.2 ENHANCED PROGRAM MESSAGE FORMAT

The enhanced program message format uses the IEEE Std. 488.2 format, syntax and status reporting. Errors are reported using the IEEE Std. 488.2 status reporting model. If an error is reported, the error is put into an Error Queue and the “ERR?” query program message can be used to get a text description of the most recent error. If you are using the IEEE-488 port, the service request line can be setup to be asserted if this occurs (see Section 4.5.2). In the enhanced format, there are two possible program message types for every program message. Each of these two types starts with the same basic text referred to as the program message header. The two types are COMMAND type and QUERY type commands.

4.3.2.1 USING COMMAND TYPE COMMANDS



Enhanced format commands DO NOT reply when using the IEEE-488 interface unless a “?” is included in the command. Do not expect a response from PPCH to non-query (no “?”) commands, as there is none. Remote software will time-out waiting for a response from PPCH. However, in RS232 communications, there is always a response and the response MUST be read prior to issuing another command.

The COMMAND type of program message executes a process and can additionally send data to the PPCH in the form of comma delimited arguments. This data is usually a setting of some sort that is stored in the PPCH. If data is specified, it must be preceded by at least one white space from the program message header and be within the range and format described in the program message description. The keyword “**Command:**” appears to the left of the required syntax in each program message description in Section 4.4.4.

If you are using the IEEE-488 port, the Command type does not generate a reply unless you place a query operator “?” immediately after the command. You also may send multiple program messages at once by separating each program message with a semicolon. The commands are queued and executed in as

received order after the entire message stream has been received, so care in determining order of execution is needed.

If you are using the RS232 port COM1, the Command type will always generate a reply so you **must** wait for a reply before issuing another program message. Because of this, you can only send one Command program message at a time while using the COM1 port.

Examples:

- **IEEE-488 enhanced mode command series using query operator:**

“*CLS?” (Clear the error queue. Wait for reply)
“UNIT? KPA” (Generates a reply. User must wait for reply before continuing)
“MMODE? A” (Generates a reply. User must wait for reply before continuing)
“PS? 100” (Generates a reply. User must wait for reply before continuing)

- **IEEE-488 enhanced mode commands without query operator:**

“*CLS” (Clear the error queue. No reply)
“UNIT KPA” (No reply)
“MMODE A” (No reply)
“PS 100” (No reply)
“ERR?” (Wait for reply. User should use “ERR?” query following a series of non-query commands to check for errors that may have occurred)

- **IEEE-488 enhanced mode multiple commands without query operator:**

“*CLS” (Clear the error queue. No reply)
“UNIT KPA;MMODE A;PS 100” (Three commands at once. No reply)
“ERR?” (Wait for reply. User should use “ERR?” query following a series of non-query commands to check for errors that may have occurred)

- **COM1 enhanced mode command:**

“*CLS” or “*CLS?” (Clear the error queue. Wait for reply)
“UNIT KPA” or “UNIT? KPA” (Generates a reply. User must wait for reply before continuing)
“MMODE A” or “MMODE? A” (Generates a reply. User must wait for reply before continuing)
“PS 100” or “PS? 100” (Generates a reply. User must wait for reply before continuing)

4.3.2.2 USING QUERY TYPE COMMANDS

The QUERY type of program message just requests data from the PPCH. Placing the query operator “?” immediately after the command creates a query. You **must** wait for a reply with a query. If you send any type of program message to the PPCH after a query before receiving a reply, the program message will be discarded and an error will be generated. Errors are reporting using the IEEE Std. 488.2 status reporting model. A Query program message always ends with a question mark. Most queries will return a reply within 200 ms except:

“PR?”, “PRR?”, “SR?”, “ATM?”, “RATE?”: Up to 2 seconds.
“RPT”, “ARANGE”: Up to 10 seconds

The syntax for using a QUERY program message is listed next to the keyword “Query:” in each program message summary in Section 4.4.4.

4.4 COMMANDS

4.4.1 PROGRAMMING MESSAGES

Table 19. Program message list

#	Send a command string out of the PPCH COM2 port.
ABORT	Stop pressure generation.
ARANGE	Read or set a new AutoRange to use.
ATM	Read the current atmospheric pressure (on-board barometer).
AUTOZERO	Read or set the status of the AutoZ automatic zeroing function.
COM1	Read or set the configuration of the COM1 port.
COM2	Read or set the configuration of the COM2 port.
DATE	Read or set the current date.
DF	Decrease the pressure quickly (fast).
DP	Decrease the pressure a given amount.
DRV	Read or set the status of the external valve drivers.
DS	Decrease pressure slowly.
ERR	Read the last error message.
GPIB	Read or set the GPIB interface address.
HEAD	Read or set the fluid head settings.
HS	Read or set the current control hold limit in pressure.
HS%	Read or set the current control hold limit in percent span of the active range.
ID	Read or set the PPCH alphanumeric ID tag.
IF	Increase the pressure quickly (fast).
IP	Slowly increase the pressure a given amount.
IS	Increase the pressure slowly.
L2	Selects "classic" program message format
L3	Selects "enhanced" program message format
LOCAL	Return control to the PPCH front panel.
MEM	Read the power-up memory test status.
MMODE	Read or change the active measurement mode.
MODE	Read or set the current pressure control mode.
MSGFMT	Read or set the type of program message format to use.
PASSTHRU	Send a command string out of the PPCH COM2 port.
PCALx	Read or set the user Hi or Lo RPT calibration information.
PCAL:XX	Read or set the user Hi or Lo RPT calibration information (obsolete format).
PR	Read the next PPCH pressure.
PRR	Read the next PPCH pressure, rate, and ATM.
PS	Set a new target pressure and start automated pressure control.
PSF	Set a new target pressure and use only the fast speed to reach the target.
PSS	Set a new target pressure and use only the slow speed to reach the target.
PUMPPR	Read the pump drive and outlet pressure.
PUMPHOURS	Read the total accumulated hours that the PPCH pump has been pressurized.
QPRR	Read the last PPCH pressure, rate and ATM.
RANGE	Read or set and Q-RPT or utility sensor default range.
RATE	Read the next available rate of change of pressure.
READYCK	Read or set a flag that is cleared by a <i>Not Ready</i> condition.
REMOTE	Enable remote local lockout operation.
RES	Read or set the pressure display resolution for the current transducer and range.
RESET	Reset the PPCH to the default user parameters.
RESLEV	Read the reservoir level status
RESLOACT	Read or set the status of the fluid reservoir low level abort action
RETURN	Start a new automated pressure control set using the current target value.
RL%	Read or set the rate mode ready limit required for a <i>Ready</i> condition.
RPT	Read the available Q-RPT data or initiate the Q-RPT search process.
RS	Set a new target rate and start automated pressure control.
SCRSV	Read or set the front panel screen saver period.
SN	Read the serial number of the PPCH.
SR	Read the next available pressure status (<i>Ready/Not Ready</i>).
SS	Read or set the stability required for a <i>Ready</i> condition.
SS%	Read or set the stability required for a <i>Ready</i> condition (% span/ s).
STAT	Read the pressure generation status.
TIME	Read or set the current time of day.
TP	Read the current target pressure.
TPCCFG	Start or check the status of a previously started volume determination (TPC configuration) (planned command as of PPCH Ver. 1.01f)
TPCVOL	Read or set the current estimate of test volume.

UCOEF	Convert a pressure in Pascal to pressure in the current units.
UDU	Read or set the user defined pressure unit.
UL	Read or set the upper limit for the current range.
UNIT	Read or set the pressure unit of measure for the current range.
VENT	Read, execute or abort a vent process.
VER	Read the PPCH software version.
ZOFFSET<i>n</i>	Read or set the AutoZ offset for Hi or Lo RPT.
ZOFFSET:XX	Read or set the AutoZ offset for Hi or Lo RPT (obsolete format)

4.4.2 ERROR MESSAGES

Table 20. Error numbers (#) and descriptions

REPLY	DESCRIPTION
ERR# 0	"OK"
ERR# 2	"Text argument is too long"
ERR# 3	"Arguments cannot be 0"
ERR# 4	"External device not detected"
ERR# 5	"External device improperly configured"
ERR# 6	"Numeric argument missing or out of range"
ERR# 7	"Missing or improper command argument(s)"
ERR# 8	"External device time-out error"
ERR# 9	"Unknown command"
ERR# 10	"Missing or invalid command suffix"
ERR# 11	"Command missing argument"
ERR# 12	"System overpressured" or "overpressure may result"
ERR# 13	"Text queue overflow"
ERR# 14	"User unit not defined"
ERR# 16	"Generation failure"
ERR# 18	"Command not yet available"
ERR# 19	"Not available with absolute units"
ERR# 20	"Not available with gauge device"
ERR# 21	"User device not defined"
ERR# 22	"Pressure is not stable"
ERR# 23	"Option not available or installed"
ERR# 24	"Unit must be vented"
ERR# 25	"Transducer out of calibration"
ERR# 26	"COM port failed to initialize"
ERR# 27	"Internal device failure"
ERR# 28	"Device failure"
ERR# 29	"Device not available"
ERR# 30	"Must be on range IH"
ERR# 31	"Limit(s) Exceeded "
ERR# 32	"Not stable enough"
ERR# 37	"Data table is full"
ERR# 38	"Selected range is not available"
ERR# 39	"Data verify error"
ERR# 43	"Incorrect mode"
ERR# 45	"Argument not allowed"
ERR #46	"Argument cannot be negative"
ERR #52	"Command obsolete"
ERR #53	"Not Available"
ERR# 54	"Not ready"
ERR# 55	"Hardware malfunction" (fluid reservoir low, will not set pressure)

4.4.3 PROGRAM MESSAGE DESCRIPTION OVERVIEW

Each program message description is separated into the following sections:

Purpose	A brief description of the programs message's function.
Command	This is the Enhanced program message syntax to send data to the PPCH or to execute a PPCH function. The PPCH must be set to use the enhanced format (see Section 3.5.2.3) to use the syntax and style shown. It may be sent alone, or followed by at least one white space and additional argument(s) to show that arguments can be passed. If there are multiple arguments, then commas must separate them. If you are using the IEEE-488 port, multiple command type program messages can be sent in one message if you separate them with a semicolon. There will be no reply from the PPCH using the IEEE-488 port unless the command is immediately followed by the query operator "?". If you are using the COM1 port, the PPC1 will reply and you must wait for this reply. If this field is not listed in the program message description, then the Command type is not supported when using the Enhanced format.
Query	This is the Enhanced program message syntax to request data from the PPCH. The PPCH must be set to use the enhanced format (see Section 3.5.2.3). The PPCH will always reply to a query. You must wait for this reply before issuing another program message. If this field (Query) is not listed in the program message description, then the Query type for the program message is not supported when using the Enhanced format.
Classic	This is the Classic program message syntax to send data to the PPCH, to execute a PPCH function, or to query for data. The PPCH must be set to use the classic format (see Section 3.5.2.3). The command may be followed by a '=' and additional argument characters to show that argument(s) can be passed. If there are multiple arguments, then commas must separate them. The PPCH will always reply to a Classic program message. You must wait for this reply before issuing another program message. If this field is not listed in the program message description, then it is not supported when using the classic format.
Arguments	If the program message can be used to set data inside the PPCH, then this section describes the arguments and their limits.
Default	If the program message can be used to set data inside the PPCH, then this line shows (using the enhanced format) the default setting from the factory.
Remarks	This field has the details and remarks about the command.
Example	Examples are given for the enhanced and classic methods. Enhanced: An example of the use of an enhanced format program message to be sent to the PPCH is shown. The message sent to the PPCH appears after the " Cmd sent: " label. If only a Query type exists, the " Query sent: " label is shown instead. Directly under this label, " Query reply " shows a typical reply to a query type. " Reply: " shows that a query format does not exist. It may have a short description next to it. Classic: An example of the use of a classic program message to be sent to the PPCH is shown. The command sent to the PPCH appears after the " Cmd sent: " label. The " Reply " label shows a typical reply to the " Sent " example. It may have a short description next to it.
Errors	If the program message can report an argument error, the types of errors are listed. If using the classic format or the COM1 port, the error message is replied after receiving the program message. If using the enhanced format via the IEEE-488 port, the error condition is handled by the status reporting model which stores the errors in an Error Queue and can be programmed to assert the IEEE-488 SRQ line to signal an error has occurred. In either case, the " ERR " or " ERR? " program message can be used to retrieve a text description of the error.
See Also	Indicates related command ("----") and refers to manual sections giving detail on PPCH operation corresponding to the program message.

4.4.4 PROGRAM MESSAGE DESCRIPTIONS

#	
Purpose	To allow the host PC to communicate with a device connected to the PPCH COM2 port.
Classic	"#xx"
Arguments	xx: The string to send out of the COM2 port. It must be less than 40 characters long.
Remarks	<p>The PPCH COM2 port can be used to communicate to another RS232 device (such as another PPCH). This allows the user to use one COM port or IEEE-488 port on the host computer to communicate with the PPCH and another device. A carriage return and a line feed (<CR><LF>) are added to the string.</p> <p>After this program message is issued, the PPCH will reply back any messages received by the PPCH COM2 port that is terminated with a carriage return. Line feeds are discarded. This will discontinue when the next program message is sent to the PPCH.</p> <p>There is no other reply from this program message. Prior to using this program message, you must ensure that the PPCH COM2 port is correctly set up to communicate with the device on COM2. Refer to the "COM2=" program message.</p> <p>If the PPCH is using an external RPM4 as the active RPT, then this command should not be used to interfere with the RPM4.</p>
Example (classic)	<p>Sent: "#VER"</p> <p>Reply: "DH INSTRUMENTS, a Fluke Company PPCH si A20M Ver1.00 "</p> <p>This example assumes that a second PPCH's COM1 port is connected to the PPCH COM2 port. This example gets the version of the second PPCH.</p>
See Also	<p>"PASSTHRU", "COM2"</p> <p>3.5.2.1</p> <hr/> <p> <i>COM2 is generally used for connecting DHI RPM4s to supply external measurement devices in which case communications are handled automatically by the PPCH,</i></p>

ABORT	
Purpose	Stops active pressure generation/control. All control valves are closed.
Command Classic	"ABORT"
Remarks	This program message has no effect if the PPCH is not using automated pressure control. When using automated pressure control, it aborts the control. This command is recommended to idle the PPCH before setting a new target pressure. It can take several seconds for open control valves to close.
Example (enhanced)	<p>Cmd sent: "ABORT"</p> <p>Reply: "ABORT" (no reply if IEEE-488)</p>
Example (enhanced)	<p>Cmd sent: "ABORT?"</p> <p>Reply: "ABORT"</p>
Example (classic)	<p>Sent: "ABORT"</p> <p>Reply: "ABORT"</p>
See Also	3.3.10.5, 3.2.2

ARANGE	
Purpose	Read or set a new AutoRange range to use.
Command Query	"ARANGE Range, unit, mode (.RptLabel)" "ARANGE?"
Classic	"ARANGE= Range, units, mode (.RptLabel)" "ARANGE"
Arguments	<p><i>Range</i> The AutoRange maximum pressure. Cannot be negative.</p> <p><i>Unit:</i> The unit of measure of the <i>Range</i> argument.</p> <p><i>Mode:</i> The measurement mode of the <i>Range</i> argument: "A" for absolute "G" for gauge</p> <p><i>RptLabel:</i> One of the Internal or External RPTs that are available. (optional) "IH": Internal, Hi Q-RPT "IL": Internal, Lo Q-RPT "X1H": First external RPM4, Hi Q-RPT "X1L": First external RPM4, Lo Q-RPT "X2H": Second external RPM4, Hi Q-RPT "X2L": Second external RPM4, Lo Q-RPT</p>
Remarks	<p>The ARANGE command is used to define a PPCH range by specifying a desired unit of measure, measurement mode and maximum pressure. The PPCH then picks the best available Q-RPT and makes operational adjustments to optimize that range. Available Q-RPTs may be determined by the use of the "RPT" command to search for external RPM4 devices or use of the [RPT] function key.</p> <p>The optional "<i>RptLabel</i>" argument can be used to specify which Q-RPT you wish to use for the AutoRange range. By using this option you can override the PPCH internal logic that picks the most suitable Q-RPT. The Q-RPT must have been previously found using the "RPT" command or the [RPT] function key and must be valid for the maximum pressure and measurement mode specified.</p> <p>The reply indicates the current range data, including the <i>RptLabel</i> used for the range.</p>
Example (enhanced)	<p>Cmd sent: "ARANGE?" (read the current range in the current units)</p> <p>Reply: "1000.0, psi, A, IH"</p>
Example (classic)	<p>Cmd sent: "ARANGE" (read the current range in the current units)</p> <p>Reply: "1000.0, psi, A, IH"</p>
Example (enhanced)	<p>Cmd sent: "ARANGE? 25, MPa, G (set a range of 25 MPa in gauge mode)</p> <p>Reply: "25.0 MPa, G, X2H" (Hi RPT of 2nd external RPM4 used)</p>
Example (classic)	<p>Cmd sent: "ARANGE=25, MPa, G (set a range of 25 MPa in gauge mode)</p> <p>Reply: "25.0 MPa, G, X1L" (Lo RPT of 1st external RPM4 used)</p>
Example (enhanced)	<p>Cmd sent: "ARANGE 5000, psi, A, X1L (set a range of 5 000 psi in absolute mode on Lo RPT of 1st RPM4)</p> <p>Reply: "500.00 psi, A, X1L" (No reply if GPIB-488)</p>
Errors	<p>ERR# 4: RPT previously found not detected. Usually occurs when the external RPM4(s) have been disconnected since the last RPT "search".</p> <p>ERR# 5: RPT previously found not the same as now found. Usually occurs when the external RPM4(s) connections to the PPCH have been changed since the last RPT "search".</p> <p>ERR# 6: "<i>Range</i>" maximum pressure exceeds available RPTs or is negative.</p> <p>ERR# 19: Cannot Range to '0' with absolute units.</p> <p>ERR# 20: Cannot Range to '0' with gauge units.</p> <p>ERR# 29: Correct type of Q-RPT for the selected "<i>Mode</i>" is not available.</p>
See Also	"RPT", "RANGE" 3.3.4, 3.2.5, 3.2.6

ATM	
Purpose	Reads the next measured pressure from PPCH's on-board barometer.
Query Classic	"ATM?" "ATM"
Remarks	The atmospheric pressure as measured by the PPCH on-board barometer is returned in the current pressure units (always absolute). This measurement is followed by the units text.
Example (enhanced)	<p>Query sent: "ATM?"</p> <p>Reply: "97.12348 kPaa"</p>
Example (classic)	<p>Sent: "ATM"</p> <p>Reply: "97.12384 kPaa"</p>
See Also	3.5.7.2

AUTOZERO	
Purpose	Read or set the status of the AutoZ function.
Command Query	"AUTOZERO <i>n</i> " "AUTOZERO?"
Classic	"AUTOZERO= <i>n</i> " "AUTOZERO"
Default	"AUTOZERO 1"
Arguments	<i>n</i> : '0' Autozero OFF '1' Autozero ON
Remarks	The PPCH AutoZ function can be turned ON and OFF. There is a separate AutoZ flag for the gauge and absolute modes for each RPT. This command sets the AutoZ status for the current mode of the active internal or external RPT only.
Example (enhanced)	Cmd sent: "AUTOZERO 0" Reply: "0" (No reply if GPIB-488)
Example (enhanced)	Cmd sent: "AUTOZERO 0" Reply: "0"
Example (classic)	Sent: "AUTOZERO=1" Reply: "AUTOZERO=0"
Errors	ERR# 6: The argument was other than a '0' or a '1'.
See Also	"ZOFFSET", "MMODE" 3.5.1

COM1	
Purpose	Read or set the RS232 settings for the COM1 port.
Command Query	"COM1 <i>baud, parity, data, stop</i> " "COM1?"
Classic	"COM1= <i>baud, parity, data, stop</i> " "COM1"
Arguments	<i>Baud</i> : The baud rate. This may be '300', '600', '1200', '2400', '4800', '9600' or '19200'. <i>Parity</i> : The data parity. This may be 'O' for odd, 'E' for even, or 'N' for none. <i>Data</i> : The number of data bits. This may be '7' or '8'. <i>Stop</i> : The number of stop bits. This may be '1' or '0'.
Defaults	"COM1 2400,E,7,1"
Remarks	The COM1 port is used to communicate to the PPCH. When the COM1 port configuration of the PPCH is changed, the program message reply (COM1 use only) is sent at the old COM1 settings, but all subsequent communications are accomplished at the new COM1 settings. A 200ms or longer delay after receiving the reply to this command ensures that the PPCH has changed the COM port settings and is ready for communications at the new settings.
Example (enhanced)	Cmd sent: "COM1 9600,N,8,1" Reply: "9600,N,8,1" (No reply if GPIB-488)
Example (enhanced)	Cmd sent: "COM1? 9600,N,8,1" Reply: "9600,N,8,1"
Example (classic)	Sent: "COM1=9600,N,8,1" Reply: "9600,N,8,1"
Errors	ERR# 7: Missing or improper program message argument(s).
See Also	"#", "PASSTHRU" 4.2.1.1

COM2	
Purpose	Read or set the RS232 settings for the COM2 port.
Command	"COM2 <i>baud,parity,data,stop</i> "
Query	"COM2?"
Classic	"COM2= <i>baud,parity,data,stop</i> " "COM2"
Arguments	<i>baud</i> : The baud rate. This may be '300', '600', '1200', '2400', '4800', '9600' or '19200'. <i>parity</i> : The data parity. This may be 'O' for odd, 'E' for even, or 'N' for none. <i>Data</i> : The number of data bits. This may be '7' or '8'. <i>stop</i> : The number of stop bits. This may be '1' or '0'.
Defaults	"COM2 2400,E,7,1"
Remarks	COM2 is generally used to connect DHI RPM4 external measurement devices. The COM2 port can also be used to allow the host computer to communicate through the PPCH to an additional device connected to COM2. This can be useful if the host computer does not have 2 serial ports available.
Example (enhanced)	Cmd sent: "COM2 9600,N,8,1" Reply: "9600,N,8,1" (No reply if GPIB-488)
Example (enhanced)	Cmd sent: "COM2? 9600,N,8,1" Reply: "9600,N,8,1"
Example (classic)	Sent: "COM2=9600,N,8,1" Reply: "9600,N,8,1"
Errors	ERR# 7: Missing or improper program message argument(s).
See Also	"#", "PASSTHRU" 3.5.2.1, 4.2.1.3

DATE	
Purpose	Read or set the PPCH date.
Command	"DATE <i>date</i> "
Query	"DATE?"
Classic	"DATE= <i>date</i> " "DATE"
Arguments	<i>date</i> : The date in the numerical only format YYYYMMDD or YYMMDD with no spaces or separators.
Remarks	The PPCH has an internal real time calendar clock. It is used for date stamping calibrations. The reply is always in the YYYYMMDD format.
Example (enhanced)	Cmd sent: "DATE 20030115" Reply: "20030105" (No reply if GPIB-488)
Example (enhanced)	Cmd sent: "DATE? 20030105" Reply: "20020105"
Example (classic)	Sent: "DATE=021201" Reply: "20021201"
Errors	ERR# 7: Missing or improper program message argument(s).
See Also	"TIME" 3.5.5.3

DF	
Purpose	Decrease the pressure quickly.
Command	"DF <i>n</i> "
Classic	"DF= <i>n</i> "
Arguments	'0' Stops the pressure generation. '1' Starts a descending generation at a fast fixed rate..
Remarks	The down control valve is used to establish a fixed rate of 2% FS/sec. The valve is closed as the pressure approaches the target.
Example (enhanced)	Cmd sent: "DF 1" Reply: "1" (no reply if IEEE-488)
Example (enhanced)	Cmd sent: "DF? 1" Reply: "1"
Example (classic)	Sent: "DF=1" Reply: "DF=1"
Errors	ERR# 6: The <i>n</i> argument is a '0' or a '1'. ERR# 55: Hardware malfunction, low reservoir
See Also	"IF", "DS", "IS", "IP", "DP", 3.2.1

DP	
Purpose	Decrease the pressure slowly by the requested amount.
Command	"DP <i>n</i> "
Classic	"DP= <i>n</i> "
Arguments	<i>n</i> : The decrease in pressure desired (current pressure units). This can be from 0 to 2 % FS of the active range.
Remarks	The down control valve will be used to decrease the pressure the requested amount at a rate of 0.2 % FS/sec. The PPCH controls pressure up to the target and then stops, so the change in pressure will be approximate.
Example (enhanced)	Cmd sent: "DP 20" Reply: "20 kPa" (no reply if IEEE-488)
Example (enhanced)	Cmd sent: "DP? 20" Reply: "20 kPa"
Example (classic)	Sent: "DP=20" Reply: "20 kPa"
Errors	ERR# 6: The <i>n</i> argument is not within given limits. ERR# 55: Hardware malfunction, fluid reservoir is low
See Also	"IP", "DS", "IS", "DF", "IF" 3.4.3, 3.1.3

DRV<i>n</i>	
Purpose	Read or set the status of external electrical drivers.
Command	"DRV <i>n</i> <i>x</i> "
Query	"DRV <i>n</i> ?"
Classic	"DRV <i>n</i> = <i>x</i> " "DRV <i>n</i> "
Arguments	<i>n</i> : The driver to operate. This can be from 1 to 8. <i>x</i> : The state to change the driver to: '0' to de-activate it, '1' to activate it.
Remarks	The PPCH control has eight optional external drivers.
Example (enhanced)	Cmd sent: "DRV1 1" Reply: "1" (No reply if GPIB-488)
Example (enhanced)	Cmd sent: "DRV2? 1" Reply: "1"
Example (classic)	Sent: "DRV1=1" Reply: "DRV1=1"
Errors	ERR# 6: The <i>n</i> or <i>x</i> arguments are not within given limits.
See Also	3.4.7

DS	
Purpose	Decrease the pressure slowly.
Command	"DS <i>n</i> "
Classic	"DS= <i>n</i> "
Arguments	'0' Stops the pressure generation. '1' Starts a descending generation at a slow fixed rate..
Remarks	The down control valve is used to establish a fixed rate of 0.2 % FS/sec. The valve is closed as the pressure approaches the target.
Example (enhanced)	Cmd sent: "DS 1" Reply: "1" (no reply if IEEE-488)
Example (enhanced)	Cmd sent: "DS? 1" Reply: "1"
Example (classic)	Sent: "DS=1" Reply: "DS=1"
Errors	ERR# 6: The <i>n</i> argument is a '0' or a '1'. ERR# 55: Hardware malfunction, fluid reservoir is low
See Also	"IF", "DF", "IS", "IP", "DP", 3.2.1

ERR	
Purpose	Read the new available error message from the Error Queue.
Query	"ERR?"
Classic	"ERR"
Remarks	This program message obtains additional details about an error that has occurred. If the user receives an "ERR# <i>nn</i> " reply, or the enhanced mode is enabled using the IEEE-488 interface and an error has been detected, the error is put into a "FIFO" (first in first out) error queue. The "ERR" program message pulls and replies the oldest error message available. "OK" is replied if there are no error messages left.
Example (enhanced):	Query sent: "ERR?" Reply: "Numeric argument missing or out of range"
Example (classic)	Sent: "ERR" Reply: "Numeric argument missing or out of range"
See Also	4.4.2

GPIB	
Purpose	Read or set the GPIB interface address.
Command	"GPIB <i>addr</i> "
Query	"GPIB?"
Classic	"GPIB= <i>addr</i> " "GPIB"
Defaults	"GPIB 10"
Arguments	<i>addr</i> : The address of the GPIB488 interface (1 to 31)
Remarks	The GPIB address is changed following the reply of this command. Each device on a GPIB interface bus requires a unique address.
Example (enhanced)	Cmd sent: "GPIB 21" Reply: "21" (No reply if GPIB-488)
Example (enhanced)	Cmd sent: "GPIB? 21" Reply: "21"
Example (classic)	Sent: "GPIB=21" Reply: "21"
Errors	ERR# 6: The argument is not within given limits.
See Also:	3.5.2.2, 4.2.1.2

HEAD	
Purpose	Read or set the fluid head settings.
Command	"HEAD <i>h,u,f</i> "
Query	"HEAD?"
Classic	"HEAD= <i>h,u,f</i> " "HEAD"
Defaults	"HEAD 0,cm,N2"
Arguments	<i>h</i> : The height of the test in relation to the PPCH. This is positive if the test is above the PPCH, or negative if below the PPCH. This value can be between - 9999 and 9999. Setting this value to '0' disables the head correction. <i>u</i> : The height units. This must be "in" or "cm". <i>f</i> : The fluid type. This must be "N2", "Air", "He", "Oil", "H2O", or "User".
Remarks	The PPCH can make a fluid head correction to allow it to display the pressure at the level of the device under test instead of at the level of the PPCH.
Example (enhanced)	Cmd sent: "HEAD 10,in,N2" Reply: "10, in, N2"
Example (classic)	Sent: "HEAD=10,in,N2" Reply: "10, in, N2"
Errors	ERR# 6: The arguments are not within given limits.
See Also:	3.3.7, 3.5.3

HS	
Purpose	"Static" or "dynamic" control modes: Read or set the automated pressure control hold limit as a pressure value. "Monotonic" control mode: Read or set the "target limit" as a pressure value.
Command	"HS <i>limit</i> "
Query	"HS?"
Classic	"HS= <i>limit</i> " "HS"
Arguments	<i>Limit</i> : The limit in the current pressure unit of measure.
Remarks	The "hold" or "target" limit can be read and set as a pressure. The "hold" limit applies to "static" and "dynamic" control modes only. These limits are part of the ready criteria. The "target" limit applied to "monotonic" control mode only. If this program message is used to set the hold or target limit, the PPCH will then use CUSTOM control settings
Example (enhanced)	Cmd sent: "HS .1" Reply: "0.100 MPa" (No reply if GPIB-488)
Example (enhanced)	Cmd sent: "HS? .1" Reply: "0.100 MPa"
Example (classic)	Sent: "HS=0.1" Reply: "0.100 MPa"
Errors	ERR# 6 The ' <i>limit</i> ' argument was invalid.
See Also	"HS%", "MODE" 3.2.2.2, 3.2.2.4

HS%	
Purpose	"Static" or "dynamic" control modes: Read or set the automated pressure control hold limit as % of range. "Monotonic" control mode: Read or set the "target limit" as a % of range.
Command Query	"HS% <i>limit</i> " "HS%?"
Classic	"HS%= <i>limit</i> " "HS%"
Arguments	<i>Limit</i> : The limit in % span of the active range.
Remarks	The "hold" or "target" limit can be read and set as a percent of the span. The "hold" limit applies to "static" and "dynamic" control modes only. These limits are part of the ready criteria. The "target" limit applied to "monotonic" control mode only. If this program message is used to set the hold or target limit, the PPCH will then use CUSTOM control settings
Example (enhanced)	Cmd sent: "HS%.01" Reply: "0.0100 %" (No reply if GPIB-488)
Example (enhanced)	Cmd sent: "HS%? 0.01" Reply: "0.0100 %"
Example (classic)	Sent: "HS%= 0.01" Reply: "0.0100 %"
Errors	ERR# 6 The ' <i>limit</i> ' argument was invalid.
See Also	"HS", "MODE" 3.2.2.2, 3.2.2.4

ID	
Purpose	Read or set the user defined instrument identification label.
Command Query	"ID <i>string</i> " "ID"
Classic	"ID= <i>string</i> " "ID"
Arguments	<i>String</i> : An alphanumeric string up to 12 characters long.
Remarks	The user defined ID label can be used to allow the user to "tag" the PPCH with a unique identifier. This ID is stored in non-volatile memory and cannot be erased by a power failure, system fault or reset
Example (enhanced)	Cmd sent: "ID PPCK #A01" Reply: "PPCK #A01" (No reply if GPIB-488)
Example (enhanced)	Cmd sent: "ID? PPCH #A01" Reply: "PPCH #A01"
Example (classic)	Sent: "ID=PPCH #A01" Reply: "PPCH #A01"
Errors	ERR# 6 The ' <i>string</i> ' argument was longer than 12 char.
See Also	3.5.5.4

IF	
Purpose	Increase the pressure quickly.
Command	"IF <i>n</i> "
Classic	"IF= <i>n</i> "
Arguments	'0' Stops the pressure generation. '1' Starts an ascending generation at a fast fixed rate.
Remarks	The up control valve is used to establish a fixed rate of 2% FS/sec. The valve is closed as the pressure approaches the target. Care must be used, as the pressure will not stop increasing until the valve is closed, or the upper limit is exceeded
Example (enhanced)	Cmd sent: "IF 1" Reply: "1" (no reply if IEEE-488)
Example (enhanced)	Cmd sent: "IF? 1" Reply: "1"
Example (classic)	Sent: "IF=1" Reply: "IF=1"
Errors	ERR# 6: The <i>n</i> argument is a '0' or a '1'. ERR# 55: Hardware malfunction, fluid reservoir is low.
See Also	"DF", "DS", "IS", "IP", "DP", 3.2.1

IP	
Purpose	Increase the pressure slowly by the requested amount.
Command	"IP <i>n</i> "
Classic	"IP= <i>n</i> "
Arguments	<i>n</i> : The increase in pressure desired (current pressure units). This can be from 0 to 2 % FS of the active range.
Remarks	The up control valve will be used to increase the pressure the requested amount at a rate of 0.2 % FS/sec. The PPCH controls pressure up to the target and then stops, so the change in pressure will be approximate.
Example (enhanced)	Cmd sent: "IP 20" Reply: "20 kPa" (no reply if IEEE-488)
Example (enhanced)	Cmd sent: "IP? 20" Reply: "20 kPa"
Example (classic)	Sent: "IP=20" Reply: "20 kPa"
Errors	ERR# 6: The <i>n</i> argument is not within given limits. ERR# 55: Hardware malfunction, reservoir level is low.
See Also	"DP", "IF", "DF", "IS", "DS" 3.4.3, 3.1.3

IS	
Purpose	Increase the pressure slowly.
Command	"IS <i>n</i> "
Classic	"IS= <i>n</i> "
Arguments	'0' Stops the pressure generation. '1' Starts an ascending generation at a slow fixed rate..
Remarks	The up control valve is used to establish a fixed rate of 0.2% FS/sec. The valve is closed as the pressure approaches the target.
Example (enhanced)	Cmd sent: "IS 1" Reply: "1" (no reply if IEEE-488)
Example (enhanced)	Cmd sent: "IS? 1" Reply: "1"
Example (classic)	Sent: "IS=1" Reply: "IS=1"
Errors	ERR# 6: The <i>n</i> argument is a '0' or a '1'. ERR# 55: Hardware malfunction, fluid reservoir is low.
See Also	"IF", "DF", "DS", "IP", "DP", 3.2.1

L2 / L3	
Purpose	Read or set the type of program command format to use (classic or enhanced).
Command	"L2"enables "classic" mode "L3"enables "enhanced" mode
Defaults	"L2" (Classic mode)
Remarks	The user can select the type of remote command format using these simplified commands. There is no query format. This format must agree with the format sent to the PPCH. This command is a replacement for the "MSGFMT" command.
Example (enhanced)	Cmd sent: "L3" Query reply: "L3" (No reply if IEEE-488)
Example (classic)	Sent: "L2" Reply: "L2"
See Also	"MSGFMT" 4.3

LOCAL	
Purpose	Returns control to the PPCH front panel.
Command	"LOCAL"
Classic	"LOCAL"
Remark	The REMOTE program message can lock the front panel out completely. The user can return to local operation by sending the LOCAL program message, sending the IEEE-488 'GTL' command (if in enhanced format), or by cycling PPCH power. A transition from remote to local operation aborts any current pressure control.
Example (enhanced)	Cmd sent: "LOCAL" Reply: "LOCAL" (no reply if IEEE-488)
Example (enhanced)	Cmd sent: "LOCAL?" Reply: "LOCAL"
Example (classic)	Sent: "LOCAL" Reply: "LOCAL"
See Also	"REMOTE"

MEM	
Purpose	Read the status from the power-up memory test.
Query	"MEM?"
Classic	"MEM"
Remarks	The PPCH system memory stores the user settings (units, resolution, control settings) and retains them when the unit is OFF. On power-up, this memory is checked. If this memory is corrupted, all user settings are reset to default, and the MEM status will be set to reflect this. Sending this query always set the MEM status to '1' after replying it's current status.
Example (enhanced)	Query sent: "MEM?" Reply: "0" PPCH data corrupted and was set to factory defaults. "1" The memory was found to be OK on power-up.
Example (classic)	Sent: "MEM" Reply: "MEM=0" PPCH data corrupted and was set to factory defaults. "MEM=1" The memory was found to be OK on power-up.
See Also	3.5.9

MODE	
Purpose	Read or set the automated pressure control mode.
Command	"MODE n"
Query	"MODE?"
Classic	"MODE=n" "MODE"
Arguments	<i>n</i> : '0' for "static" control. '1,0' or '1' for "standard dynamic" control. '1,1' for "hi volume dynamic" control '2' for "monotonic" control. '3' for "rate" control.
Remarks	The method which the PPCH controls pressure is selected with the "MODE" program message. When the control mode is set, control parameters are set to default parameters for that range. The control mode setting is range dependent.
Example (enhanced)	Cmd sent: "MODE 1" Reply: "1" (No reply if GPIB-488)
Example (enhanced)	Cmd sent: "MODE? 1" Reply: "1"
Example (classic)	Sent: "MODE=1" Reply: "MODE=1"
Errors	ERR# 6 The argument is invalid.
See Also	"HS", "SS", "RL" 3.4.6, 3.2.2

MMODE	
Purpose	Read or change the active measurement mode.
Command	"MMODE=mode"
Query	"MMODE"
Classic	"MMODE=mode" "MMODE "
Arguments	<i>Mode</i> : "A" Absolute mode "G" Gauge mode
Remarks	The active RPT or an AutoRange range should selected before setting measurement mode since measurement mode is range specific. The measurement mode can also be set using the "UNIT" command.
Example (enhanced)	Cmd sent: "MMODE A" Reply: "A" (No reply if IEEE-488)
Example (enhanced)	Cmd sent: "MMODE? A" Reply: "A"
Example (enhanced)	Cmd sent: "MMODE=G" Reply: "G"
Errors	ERR# 6: Invalid argument text. ERR# 20: Absolute mode not available on absolute RPT with absolute use disabled.
See Also	"UNIT" 3.3.3

MSGFMT	
Purpose	Read or set the type of program command format to use (enhanced or classic).
Command	"MSGFMT <i>n</i>
Query	"MSGFMT?"
Classic	"MSGFMT= <i>n</i> "MSGFMT"
Arguments	<i>n</i> : '1' to use the enhanced command format. '0' to use the classic command format.
Defaults	"MSGFMT 0"
Remarks	The user can select the type of remote command format to use. This format must agree with the format sent to the PPCH. The enhanced query form of this command ("MSGFMT? <i>n</i> ") should always be used to set the desired format, as it will be accepted regardless of the current format (classic or enhanced).
Example (enhanced)	Cmd sent: "MSGFMT 1" Reply: "1" (No reply if IEEE-488)
Example (enhanced)	Cmd sent: "MSGFMT? 1" Reply: "1"
Example (classic)	Sent: "MSGFMT=1" Reply: "MSGFMT=1"
Errors	ERR# 6: Missing or improper program message argument(s).
See Also	4.3

PASSTHRU	
Purpose	To allow the host PC to communicate with a device connected to the PPCH COM2 port.
Command	"PASSTHRU <i>n</i>
Query	"PASSTHRU?"
Classic	"PASSTHRU= <i>n</i> " "PASSTHRU"
Arguments	<i>n</i> : The string to send out of the COM2 port. It must be less than 40 characters long.
Remarks	Generally, the PPCH COM2 port is used for communication with DHI RPM4s used as PPCH external measurement devices. The COM2 port can alternatively be used to communicate to another RS232 device (such as another PPCH). This allows the user to use one COM port or IEEE-488 port on the host computer to communicate with the PPCH and another device. The Command format specifies and sends the argument. A carriage return and a line feed (<CR><LF>) are added to the string that is sent. The Query format is used to check the PPCH COM2 receive buffer to see if a message has been received on COM2 from the device. The message received by the COM2 port must be terminated with a carriage return or a carriage return and a line feed. Only one message is retained by the COM2 port. The label "COM2:" precedes the message text. If the COM2 receive buffer is empty, then the reply is just be "COM2:" If the PPCH is using an external RPM4 as the active RPT, then this command should not be used to interfere with the RPM4. The '#' command can also be used for this sort of operation, but with fewer options available.
Example (enhanced)	Cmd sent: "PASSTHRU=VER" Reply: "COM2:DH INSTRUMENTS, A FLUKE COMPANY PPCH VER1.01a" Reply: "COM2:" (If the COM2 buffer is empty)
Example (classic)	Sent: "PASSTHRU=VER" Reply: "COM2:DH INSTRUMENTS, A FLUKE COMPANY PPCH VER1.01a" Reply: "COM2:" (If the COM2 buffer is empty)
See Also	"#", "COM2"

PCALn (PCAL:XX)	
Purpose	Read or set the Q-RPT or utility sensor calibration information for the "IH" (internal high) and "IL" (internal low) RPTs.
Command Query	"PCALn <i>adder, mult, CalDate, (GaOnly)</i> " "PCALn?"
Classic	"PCALn= <i>adder, mult, CalDate, (GaOnly)</i> " "PCALn"
Defaults	"PCALn = 0.0, 1.0, 19800101, 0"
Optional Suffix	"n" The active RPT is assumed if no suffix is given. The "Hi" RPT is assumed if the HL RPT is active and no suffix is given. '1' Specify the Hi RPT '2' Specify the Lo RPT
Arguments	<i>Adder</i> : The RPT calibration adder (PA). In Pascal. <i>Mult</i> : The RPT calibration multiplier (PM) from 0.1 to 100. <i>CalDate</i> : The date of the calibration in the format "YYYYMMDD" by default. Any other format up to 8 characters long will also be accepted, and the replied format is in the previously entered format. <i>GaOnly</i> Optional "Gauge only" flag. Indicates that the an Axxx Q-RPT is set to operate in gauge measurement mode only. This field does not apply for utility sensors. '0' Absolute and gauge modes are available. '1' Gauge mode only.
Remarks	The user defined pressure calibration information for the specified RPT (Hi or Lo pressure) can be accessed with this program message. Using this program message overwrites the current calibration coefficients, so caution must be used. If the " <i>GaMode</i> " flag is set, then the RPT will only be allowed to operate in gauge mode. Changes made using this program message take effect immediately. The calibration information of DHI RPM4s connected to PPCH must be adjusted directly on the RPM4. The information cannot be adjusted through the PPCH.
Example (enhanced)	Cmd sent: "PCAL1 2.1, 1.000021, 20011201, 0" ("Hi" RPT calibration) Reply: " 2.10 Pa, 1.000021, 20011201, 0" (No reply if GPIB-488)
Example (enhanced)	Cmd sent: "PCAL1? 2.1, 1.000021, 20011201, 0" Reply: " 2.10 Pa, 1.000021, 20011201, 0"
Example (classic)	Sent: "PCAL2=2.1, 1.000021, 20011201, 1" ("Lo" RPT calibration) Reply: " 2.10 Pa, 1.000021, 20011201, 1"
Errors	ERR# 2 The <i>CalDate</i> exceeds 8 digits ERR# 6: One of the numeric arguments are out of range.
See Also	5.2

PR	
Purpose	Read the next available pressure.
Query	"PR?"
Classic	"PR"
Remarks	The next available pressure value for the active Q-RPT or utility sensor is read in the current pressure units. The data returned also contains <i>Ready/Not Ready</i> information, and the pressure unit of measure and measurement mode. The reply field is always 20 characters long. The first 3 characters of the reply are reserved for the ready status, typically 'R' or 'NR'. The complete ready status is described in the "SR" program message. The pressure value and pressure unit of measure are right justified in this field. After receiving this program message, the PPCH replies back with the data after a new pressure measurement cycle is complete. This can take up to 1.5 seconds.
Example (enhanced)	Query sent: "PR?" Reply: "R 19.367 MPa a"
Example (classic)	Query sent: "PR" Reply: "R 19.367 MPa a"
See Also	"PRR", "QPRR", "SR" 3.1.1, 3.2.2

PRR	
Purpose	Read the next available pressure, rate and on-board barometer reading.
Query	"PRR?"
Classic	"PRR"
Remarks	<p>The next available <i>Ready</i> condition, Q-RPT or utility sensor pressure, rate of pressure change, and barometric pressure is replied in the current pressure unit of measure. Each data field is separated by a comma, and is returned in the following order: ready, pressure UNITS, rate UNITS/s, atm UNITS</p> <p>Here are the field descriptions:</p> <p>ready: 'R' if the current pressure <i>Ready</i> criteria have been met, Typically 'NR' if the criteria have not been met. The complete <i>Ready</i> status is described in the "SR" program message.</p> <p>pressure: The measured pressure for the active Q-RPT or utility sensor in the current pressure unit. This is followed by the current pressure unit.</p> <p>rate: The measured rate of pressure change for the active Q-RPT or utility sensor in the current pressure unit per second. This is followed by the current pressure unit of measure.</p> <p>atm: The pressure measured by the PPCH on-board barometer in the current pressure unit (and always absolute). It is displayed in it's full resolution. This is followed by the current pressure unit.</p> <p>After receiving this program message query, the PPCH replies back with the data once a new pressure measurement cycle is complete. This can take up to 1.5 seconds.</p>
Example (enhanced)	Query sent: "PRR?" Reply: "R,23.0626 MPa a,0.011 MPa/s, 0.097001 MPa a"
Example (classic)	Query sent: "PRR" Reply: "R,23.0626 MPa a,0.011 MPa/s, 0.097001 MPa a"
See Also	"PR", "QPRR", "SR", "ATM" 3.1.1, 3.5.7.2

PS	
Purpose	Set a new target pressure and start a new pressure control cycle. Allows the test volume to be specified which causes the pressure control cycle to be executed omitting the automated control configuration routine.
Command	"PS n (.v)"
Classic	"PS=n (.v)"
Arguments	<p><i>n</i>: The target pressure in the current pressure units.</p> <p><i>v</i>: The volume of the system connected to the PPCH TEST port in cm³ (cc). This argument is optional and should be used only to reduce pressure-setting time in known volumes.</p>
Remarks	<p>The PPCH sets the specified target pressure using the current control settings and mode. Control continues until a new target pressure is set (except in monotonic mode), the PPCH goes into LOCAL mode, or an "ABORT" program message is executed. If the given target is '0', the PPCH vents.</p> <p>The "PR?", "PRR?", "STAT?", or "SR?" program message queries can be used to monitor the progress of the pressure setting routine.</p> <p>If the optional "v" argument is used, the PPCH does not attempt to perform its test volume determination routine at the beginning of the pressure setting procedure, but instead uses the volume specified for the pressure control. This can reduce pressure set times when operating into a consistent volume. The "v" argument should only be used in automated conditions, where the test volume is constant and the configuration does not change. This argument is only an approximation value, and it may be adjusted empirically for correct operation. A higher "v" setting speeds up the generation with a higher risk of significant control overshoot. A lower "v" setting slows down the generation and reduces overshoot.</p>
Example (enhanced)	Cmd sent: "PS 1000" Reply: "1000 kPa a " (no reply if IEEE-488)
Example (enhanced)	Cmd sent: "PS? 1000" Reply: "1000 kPa a "
Example (classic)	Sent: "PS=1000, 75" (includes test volume definition) Reply: "1000 kPa a "
Errors	<p>ERR# 6 The target pressure is out of range.</p> <p>ERR# 8 Active external RPM4 timeout.</p> <p>ERR# 12 Pressure has exceeded maximum limits.</p> <p>ERR#18 This command not valid in "rate" generation mode.</p> <p>ERR# 55 Hardware malfunction, reservoir level low.</p>
See Also	"PR", "PRR", "STAT", "SR", "QPRR", "RS" 3.2.2, 3.3.10, 3.2.1

PSF	
Purpose	Set a new target pressure, using a fast fixed rate and aborting pressure control once the target is reached.
Command	"PSF <i>n</i> "
Classic	"PSF= <i>n</i> "
Arguments	<i>N</i> : The target pressure in the current pressure unit.
Remarks	The PPCH sets the given target pressure using a rate of 2 % FS/sec, and stops controlling as the pressure approaches the given target. The system does not attempt to maintain the target pressure. The "PR?", "PRR?", "STAT?", or "SR?" program message queries can be used to monitor the progress of the generation.
Example (enhanced)	Cmd sent: "PSF 1000" Reply: "1000 kPa a (no reply if IEEE-488)"
Example (classic)	Sent: "PSF=1000" Reply: "1000 kPa a"
Errors	ERR# 6 The target pressure is out of range. ERR# 8 Active external RPM4 timeout. ERR# 12 Pressure has exceeded maximum limits. ERR# 55 Hardware malfunction, reservoir level low.
See Also	"PR", "PRR", "STAT", "SR", "PSS", "PS" 3.2.1

PSS	
Purpose	Set a new target pressure using a slow fixed rate and aborting pressure control once the target is reached.
Command	"PSS <i>n</i> "
Classic	"PSS= <i>n</i> "
Arguments	<i>N</i> : The target pressure in the current pressure units.
Remarks	The PPCH sets the given target pressure using a rate of 0.2% FS/sec, and stops controlling when the pressure has reached or passed the given target. The system does not attempt to maintain the target pressure. The "PR?", "PRR?", "STAT?", or "SR?" program message can be used to monitor the progress of the generation.
Example (enhanced)	Cmd sent: "PSS 1000" Reply: "1000 kPaa" (no reply if IEEE-488)
Example (enhanced)	Cmd sent: "PSS? 1000" Reply: "1000 kPaa"
Example (classic)	Sent: "PSS=1000" Reply: "1000 kPaa"
Errors	ERR# 6 The target pressure is out of range. ERR# 8 Active external RPM4 timeout. ERR# 12 Pressure has exceeded maximum limits. ERR# 55 Hardware malfunction, reservoir level low
See Also	"PR", "PRR", "STAT", "SR", "PSF", "PS" 3.2.1

PUMPPR	
Purpose	Read the pump drive and outlet pressure.
Query	"PUMPPR?"
Classic	"PUMPPR"
Remarks	The last known measured pump drive pressure and calculated pump outlet pressure is replied in the current pressure units.
Example (enhanced)	Query sent: "PUMPPR?" Reply: "366.7 kPa,76307.5 MPa"
Example (classic)	Query sent: "PUMPPR" Reply: "366.7 kPa,76307.5 MPa"
See Also	3.5.7.3.3, 3.2.1

PUMPHOURS	
Purpose	Read the total accumulated hours that the PPCH pump has been pressurized.
Query	"PUMPHOURS?"
Classic	"PUMPHOUS"
Remarks	The PPCH drive pump timer keeps track of how long the pump has has been pressurized since being serviced.
Example (enhanced)	Cmd sent: "PUMPHOURS?" Reply: "22"
Example (classic)	Sent: "PUMPHOURS" Reply: "22"
See Also	3.5.7.3.4

QPRR	
Purpose	Read the last RPT pressure, pressure rate and on-board barometer output as quickly as possible.
Query	"QPRR?"
Classic	"QPRR"
Remarks	<p>The last measured <i>Ready/Not Ready</i> condition, active Q-RPT or utility sensor pressure, rate of pressure change, and barometric pressure is replied in the current pressure unit of measure. This program message is useful when a rapid response of measured pressure is needed. Each data field is separated by a comma, and is returned in the following order: ready, pressure UNITS, rate UNITS/s, atm UNITS</p> <p>Here are the field descriptions:</p> <p>ready: 'R' if the current pressure <i>Ready</i> criteria has been met, 'NR' if the criteria has not been met (see the "SR" program message).</p> <p>pressure: The measured pressure for the selected Q-RPT or utility sensor in the current pressure units. This is followed by the current pressure unit and measurement mode.</p> <p>rate: The measured rate of pressure change for the active Q-RPT or utility sensor in the current unit of pressure per second. This is followed by the current pressure unit of measure.</p> <p>atm: The pressure measured by the PPCH on-board barometer in the current pressure unit (but always absolute). This is followed by the current pressure unit.</p>
Example (enhanced)	Query sent: "QPRR?" Reply: "R,2.306 MPa a,0.011 MPa/s,97.000 kPa a"
Example (classic)	Query sent: "QPRR" Reply: "R,2.306 MPa a,0.011 MPa/s,97.000 kPa a"
See Also	"PR", "PRR", "SR" 3.1.1, 3.5.7.2

RANGE	
Purpose	Change the active range to one of the available internal or external default Q-RPT ranges. Read the active range full scale, pressure unit and measurement mode.
Command Query	"RANGE <i>Rng</i> " "RANGE?"
Classic	"RANGE= <i>Rng</i> " "RANGE "
Default	<p>"RANGE IH"</p> <p><i>Rng</i>: "IH" for the internal, hi Q-RPT or utility sensor "IL" for the internal lo Q-RPT "X1H" for the first external RPM4, hi Q-RPT "X1L" for the first external RPM4, lo Q-RPT "X2H" for the second external RPM4, hi Q-RPT "X2L" for the second external RPM4, lo Q-RPT</p>
Remarks	<p>The active RPT must be selected before making changes to settings that are dependent on the range. The system MUST BE VENTED to change active RPTs.</p> <p>RPTs selected with this command are used with their full default pressure range. External RPTs must be found and initialized using the "RPT" command or function key before they can be selected.</p> <p>The reply indicates the active range in psi if the PPCH is a "US" version or in kPa if the PPCH is an "SI" version.</p> <p>Used as a simple query, the active range is returned, which can be an AutoRanged range or a default range (see "ARANGE" cmd).</p>
Example (enhanced)	Cmd sent: "RANGE IL" (select internal Lo Q-RPT in it's full default range) Reply: "5000 psia"
Example (classic)	Sent: "RANGE=IH" (select internal Hi Q-RPT in it's full default range) Reply: "10000 psia"
Example (classic)	Sent: "RANGE=X2H"(select external 2 nd RPM4, HI Q-RPT) Reply: "5000 psia"
Example (classic)	Sent: "RANGE" (request current range) Reply: "220000 psia"
Errors	ERR# 6: Invalid <i>Rng</i> argument. ERR# 22: System must be vented for the requested operation. ERR# 38: The selected RPT is not available.
See Also	"ARANGE", "RPT" 3.2.6, 3.3.1, 3.3.4

RATE	
Purpose	Read the next available pressure rate of change.
Query	"RATE?"
Classic	"RATE"
Remarks	The next available pressure rate of change in the current pressure unit per second is returned. After receiving this program message, the PPCH replies back with the data once a new pressure measurement cycle is complete. This can take up to 1.5 seconds.
Example (enhanced)	Query sent: "RATE?" Reply: "0.012 MPa/s"
Example (classic)	Sent: "RATE" Reply: "0.012 MPa/s"
See Also	"PRR", "QPRR"

READYCK	
Purpose	Read or set the <i>Ready</i> check flag.
Command	"READYCK 1"
Query	"READYCK?"
Classic	"READYCK=1" "READYCK"
Remarks	The internal ready check flag is cleared whenever the PPCH reaches a <i>Not Ready</i> (NR) condition. The "READYCK" query returns the status of the flag. Sending the "READYCK 1" program message while the PPCH is in a <i>Ready</i> condition sets the flag. The "READYCK" program message query can then be used at a later time to determine whether a <i>Not Ready</i> condition has occurred since the ready check flag was set.
Example (enhanced)	Cmd sent: "READYCK 1" Reply: "1" (no reply if GPIB-488)
Example (enhanced)	Cmd sent: "READYCK?" Reply: "1"
Example (enhanced)	Cmd sent: "READYCK?" Reply: "1" (if PPCH condition has stayed <i>Ready</i>) "0" (if PPCH condition has NOT stayed <i>Ready</i>)
Example (classic)	Sent: "READYCK=1" Reply: "READYCK=1"
Example (classic)	Sent: "READYCK" Reply: "READYCK=1" (if PPCH condition has stayed <i>Ready</i>) "READYCK=0" (if PPCH condition has NOT stayed <i>Ready</i>)
Errors	ERR# 6: Argument is not a '0' or a '1'.
See Also	"SR", "STAT" 3.2.3

REMOTE	
Purpose	Lock out the front panel keypads during remote operation.
Command	"REMOTE"
Classic	"REMOTE"
Remarks	The PPCH goes into remote mode whenever communications take place. The user can return to local operation by pressing the [ESC] key. The REMOTE program message locks out the front panel completely. The only way to unlock the front panel after the "REMOTE" command is using the "LOCAL" program message, the IEEE-488 "GTL" command, or by cycling the PPCH power. A transition from remote to local operation aborts any current pressure control.
Example (enhanced)	Cmd sent: "REMOTE" Reply: "REMOTE" (no reply if IEEE-488)
Example (enhanced)	Cmd sent: "REMOTE?" Reply: "REMOTE"
Example (classic)	Sent: "REMOTE" Reply: "REMOTE"
See Also	"LOCAL"

RES	
Purpose	To read or set the pressure display resolution for the active range.
Command	"RES <i>n</i> "
Query	"RES?"
Classic	"RES= <i>n</i> " "RES"
Default	"RES 0.001"
Arguments	<i>n</i> : The pressure display resolution in % span of the current RPT range (0.0001 to 1 % FS).
Remarks	The pressure display resolution is defined as % span of the active range. The setting is separate for each range, and changes as the range is changed.
Example (enhanced)	Cmd sent: "RES .01" Reply: "0.01" (No reply if GPIB-488)
Example (enhanced)	Cmd sent: "RES? .01" Reply: "0.01"
Example (classic)	Sent: "RES=.01" Reply: "0.01"
Errors	ERR# 6 The argument is invalid.
See Also	3.4.2

RESET	
Purpose	Reset the user's settings to factory defaults.
Command	"RESET"
Classic	"RESET"
Remarks	The PPCH has user settings (units, resolution, control modes, etc.) that can be reset to factory defaults. System calibration coefficients and communications settings are not affected. The remote "RESET" program message corresponds to the front panel "Reset - Sets." The reset cycle takes up to 3 seconds to complete. Remote communications should not take place during this period.
Example (enhanced)	Cmd sent: "RESET" Reply: "RESET" (no reply if IEEE-488)
Example (enhanced)	Cmd sent: "RESET?" Reply: "RESET"
Example (classic)	Sent: "RESET" Reply: "RESET"
See Also	3.5.4.1

RESLEV	
Purpose	To read the reservoir level status.
Query	"RESLEV?"
Classic	"RESLEV"
Remarks	The reservoir level query indicates if the level is sufficient for operation, or is low. A reply of '1' indicates an "OK" level. A '0' indicates a low level. A low level does not hinder normal operation, but should be tended to.
Example (enhanced)	Query sent: "RESLEV?" Reply: "1" (level is OK)
Example (classic)	Query sent: "RESLEV" Reply: "0" (Level is LOW)
See Also	3.5.7.3.2

RESLOACT	
Purpose	Read or set the status of the fluid reservoir low abort action.
Command	"RESLOACT <i>n</i> "
Query	"RESLOACT?"
Classic	"RESLOACT= <i>n</i> " "RESLOACT"
Default	"RESLOACT 1"
Arguments	<i>n</i> : '0' Take no action when the reservoir is low '1' Abort generation and prevent new pressure excursions when the reservoir is low
Remarks	The PPCH monitors the level of the reservoir and can take action if desired when the level is low.
Example (enhanced)	Cmd sent: "RESLOACT 1" Reply: "1" (No reply if GPIB-488)
Example (enhanced)	Cmd sent: "RESLOACT 1" Reply: "1"
Example (classic)	Sent: "RESLOACT=1" Reply: "RESLOACT=1"
Errors	ERR# 6: The argument was other than a '0' or a '1'.
See Also	"RESLEV" 3.5.7.3.2

RETURN	
Purpose	Start a new pressure setting sequence equivalent to the "PS" command using the last target pressure.
Command	"RETURN"
Classic	"RETURN"
Remarks	The "RETURN" program message starts a new pressure setting sequence using the current settings and target pressure. Pressure control continues until a new target pressure is set, the PPCH is put into LOCAL mode, or an "ABORT" program message is executed.
Example (enhanced)	Cmd sent: "RETURN" Reply: "1000.000 kPaa" (no reply if IEEE-488)
Example (classic)	Sent: "RETURN" Reply: "1000.000 kPaa"
Errors	ERR# 6 The target pressure is out of range. ERR# 8 Active external RPM4 timeout. ERR# 12 Pressure has exceeded maximum limits. ERR #18 This command not valid in "rate" control mode. ERR# 55 Hardware malfunction, reservoir low.
See Also	"PS", "TP" 3.3.10

RL%	
Purpose	Read or set the ramp control mode rate ready limit.
Command	"RL% n"
Query	"RL%?"
Classic	"RL%=n" "RL%"
Arguments	n: The rate limit in % of the requested rate / sec.
Remarks	The rate limit is used only in "ramp" control mode to determine ready criteria. It is in % of the current rate target. If this program message is used to set the rate ready limit, the PPCH will then indicate CUSTOM control settings.
Example (enhanced)	Cmd sent: "RL% 10" Reply: "10.0 %/s"(No reply from GPIB-488)
Example (enhanced)	Cmd sent: "RL%? 10" Reply: "10.0 %/s"
Example (classic)	Sent: "RL%=10" Reply: "10.0 %/s"
Errors	ERR# 6 The argument was invalid.
See Also	"RL" 3.2.2.5, 3.4.6.1

RPT(<i>n</i>)	
Purpose	Read the available RPT data or initiate the RPT search and initialize process.
Command Query	"RPT" "RPT(<i>n</i>)"
Classic	"RPT" "RPT(<i>n</i>)"
Default	"RPT"
Prefix (optional)	<i>n</i> Specify the position locator of the RPT about which to collect information: '1' The internal, Hi RPT '2' The internal, Lo, RPT '3' The first external RPM4, Hi RPT '4' The first external RPM4, Lo RPT '5' The second external RPM4, Hi RPT '6' The second external RPM4, Lo RPT
Remarks	<p>Up to six RPTs can be available for use in one PPCH system. Two of these can be internal, and the other four are external. These RPTs must be identified and initialized before they can be used by the PPCH. This command allows the search process to be executed (by omitting the prefix 'n') and allows review of the RPTs identified. Note that the search process can take up to 10 seconds to complete, and that the communications settings for the PPCH's COM2 port and the external RPM4 devices should be setup prior to this. If you are querying the unit for information about a particular RPT Using the prefix 'n'), then the RPT data found during the execution of the last search is returned in the following format:</p> <p><i>RPTType, RPTLocator, Serial#, RngGa, RngAbs, RptMode</i></p> <p><i>RngLabe:</i> RPT type label. This label identifies the RPT type and range. This is the same label used on the PPCH front panel screen.</p> <p><i>RptLocator:</i> Text field identifying the RPT position in the PPCH system. "IH" identifies this as an internal, Hi Q-RPT "luH" identifies this as an internal, Hi utility sensor "IL" identifies this as an internal, Lo Q-RPT "X1H" identifies this as the first external RPM4, Hi Q-RPT "X1H" identifies this as the first external RPM4, Lo Q-RPT "X2H" identifies this as the second external RPM4, Hi Q-RPT "X2H" identifies this as the second external RPM4, Lo Q-RPT</p> <p><i>Serial#:</i> The serial number of the PPCH or RPM4 In which the RPT is located. <i>RngGa:</i> The RPT gauge mode range in the current pressure unit. <i>RngAbs:</i> The RPT absolute mode range in the current pressure unit. <i>RptMode:</i> 'A' if RPT supports absolute and gauge. 'G' if RPT has absolute OFF and supports only gauge measurement mode.</p>
Example (enhanced)	<p>Cmd sent: "RPT?" (find external RPTs in RPM4(s)) Reply: "OK" (takes up to 10 seconds to reply)</p>
Example (classic)	<p>Cmd sent: "RPT" (find external RPTs in RPM4(s)) Reply: "OK" (takes up to 10 seconds to reply)</p>
Example (enhanced)	<p>Cmd sent: "RPT2?" (Get information on internal, Lo RPT) Reply: "A70M, IL, 82345, 70, 70,A"</p>
Example (classic)	<p>Cmd sent: "RPT6" (Get information on RPT in ext RPM4, Lo position) Reply: "A100M, IH, 82345, 100, 100,A"</p>
Errors	<p>ERR# 4: RPT not previously found ERR# 10: Invalid prefix.</p>
See Also	"ARANGE", "COM2" 3.3.5, 3.2.5

RS	
Purpose	Set a new target rate and start a new control cycle. Allows the test volume to be specified which causes the pressure control cycle to be executed omitting the automated control configuration routine.
Command	"RS <i>n</i> (<i>,v</i>)"
Classic	"RS= <i>n</i> (<i>,v</i>)"
Arguments	<i>n</i> : The target rate in the current pressure units per second. Negative for descending rates. The target rate cannot be '0' <i>v</i> : The volume of the system connected to the PPCH TEST(+) port in cm ³ (cc). This argument is optional and should be used only to reduce pressure-setting time in known volumes.
Remarks	The PPCH sets the specified target rate using the current control settings and mode. Control continues until a new target rate or pressure is set, the upper limit is reached, the PPCH goes into LOCAL mode, or an "ABORT" program message is executed. The "PR?", "PRR?", "STAT?", or "SR?" program message queries can be used to monitor the progress of the pressure setting routine. If the optional " <i>v</i> " argument is used, the PPCH does not attempt to perform its test volume determination routine at the beginning of the pressure setting procedure, but instead uses the volume specified for the pressure control. This can reduce pressure set times when operating into a consistent volume. The " <i>v</i> " argument should only be used in automated conditions, where the test volume is constant and the configuration does not change. This argument is only an approximation value, and it may be adjusted empirically for correct operation. A higher " <i>v</i> " setting speeds up the generation with a higher risk of significant control overshoot. A lower " <i>v</i> " setting slows down the generation and reduces overshoot.
Example (enhanced)	Cmd sent: "RS 10" Reply: "10 kPa/s" (no reply if IEEE-488)
Example (enhanced)	Cmd sent: "RS? 1000" Reply: "10 kPa/s"
Example (classic)	Sent: "RS=10, 75" (includes test volume definition) Reply: "10 kPa/s"
Errors	ERR# 6 The target rate is out of range. ERR# 8 Active external RPM4 timeout. ERR# 12 Pressure has exceeded maximum limits. ERR# 55 Hardware malfunction, low reservoir
See Also	"PR", "PRR", "STAT", "SR", "QPRR, UL" 3.2.2.5, 3.3.10.4, 3.2.1

SCRSAV	
Purpose	Read or set the front panel display screen saver activation time.
Command	"SCRSAV <i>n</i> "
Query	"SCRSAV?"
Classic	"SCRSAV= <i>n</i> " "SCRSAV"
Arguments	<i>n</i> : The inactivity period. (minutes) after which screen saver activates (0-99).
Default	"SCRSAV 10"
Remarks	The PPCH front panel will dim after a period of keyboard and remote inactivity. Setting this value to '0' disables this feature.
Example (enhanced)	Cmd sent: "SCRSAV 30" Reply: "30" (No reply if GPIB-488)
Example (enhanced)	Cmd sent: "SCRSAV? 30" Reply: "30"
Example (classic)	Sent: "SCRSAV=30" Reply: "30"
Errors	ERR# 6 The argument was invalid.
See Also	3.5.5.1

SN	
Purpose	To read the serial number of the PPCH.
Query	"SN?"
Classic	"SN"
Remarks	The PPCH is serialized. The serial number can be read using this program message.
Example (enhanced)	Query sent: "SN?" Reply: "321"
Example (classic)	Sent: "SN" Reply: "321"
See Also	3.5.5.4

SR	
Purpose	Read the next available <i>Ready/Not Ready</i> status.
Query	"SR?"
Classic	"SR"
Remarks	The current <i>Ready</i> status can be read using this program message. Possible replies: "NR" The pressure is Not Ready within the limits defined by the control mode and current control parameters. "R" The pressure meets the ready criteria. The status is replied when the next pressure measurement is finished. "LR" Reservoir low and the low reservoir action is abort which prevents pressure control. "OL" The pressure of one of the active RPTs has exceeded the user defined upper or lower limits . "OP" The pressure of one of the RPTs has exceeded the RPT's maximum limits. "TO" Active external RPM4 timeout. "ER" Active external RPM4 communications fault. "XE" Active external RPM4 not connected to PPCH test port.
Example (enhanced)	Query sent: "SR?" Reply: "NR"
Example (classic)	Sent: "SR" Reply: "NR"
See Also	"PR", "PRR", "HS", "SS", "UL", "LL" 3.2.3, 3.4.4, 3.4.4.1, 3.5.7.3.2

SS%	
Purpose	"Static" or "dynamic" control modes: Read or set the current stability limit as a % of range. "Monotonic" control mode: Read or set the "rate limit" as a % of range.
Command Query	"SS% n" "SS%?"
Classic	"SS%=n" "SS%"
Arguments	<i>n</i> : The stability or rate limit in %FS of the current active range.
Remarks	The stability or rate limit can be read and set as a percent of the full scale range of the RPT range. These limits are part of the ready criteria. The "stability" limit applies to "static" and "dynamic" control modes only. The "rate" limit applied to "monotonic" control mode only. If this program message is used to set the stability or rate limit, the PPCH will then use CUSTOM control settings.
Example (enhanced)	Cmd sent: "SS% .1" Reply: "0.10 %" (No reply from GPIB-488)
Example (enhanced)	Cmd sent: "SS%? .1" Reply: "0.10 %"
Example (classic)	Sent: "SS%=.1" Reply: "0.10 %"
Errors	ERR# 6 The argument was invalid.
See Also	"SS" 3.2.2.2, 3.2.2.3, 3.2.2.4, 3.4.6.1

SS	
Purpose	"Static" or "dynamic" control modes: Read or set the current stability limit as a pressure value. "Monotonic" control mode: Read or set the "rate limit" as a pressure value.
Command Query	"SS n" "SS?"
Classic	"SS=n" "SS"
Arguments	<i>n</i> : The stability or rate limit in the current pressure unit of measure.
Remarks	The stability or rate limit can be read and set as a pressure in the current units. These limits are part of the ready criteria. The "stability" limit applies to "static" and "dynamic" control modes only. The "rate" limit applied to "monotonic" control mode only. If this program message is used to set the stability or rate limit, the PPCH will then use CUSTOM control settings.
Example (enhanced)	Cmd sent: "SS .1" Reply: "0.100 MPa/s" (No reply from GPIB-488)
Example (enhanced)	Cmd sent: "SS? .1" Reply: "0.100 MPa/s"
Example (classic)	Sent: "SS=.1" Reply: "0.100 MPa/s"
Errors	ERR# 6 The argument was invalid.
See Also	"HS" 3.2.2.2, 3.2.2.3, 3.2.2.4, 3.4.6.1

STAT	
Purpose	Read the pressure control status.
Query	"STAT?"
Classic	"STAT"
Remarks	The pressure or rate control cycle status can be checked using this program message. It returns a '1' if the PPCH is actively controlling a pressure, a rate, is venting, or is holding a pressure. It returns a '0' if it is idle or completely vented..
Example (enhanced)	Query sent: "STAT?" Reply: "1"
Example (classic)	Sent: "STAT" Reply: "1"
See Also	"PS", "RS" 3.2.2, 3.3.10

TIME	
Purpose	Read or set the PPCH internal clock.
Command	"TIME hh:mmXX"
Query	"TIME?"
Classic	"TIME=hh:mmXX" "TIME"
Arguments	hh:mm: The time in a 12 hour format using a colon delimiter XX: "am" or "pm"
Remarks	The PPCH has an internal real time clock. It is used for date stamping calibrations and log data.
Example (enhanced)	Cmd sent: "TIME 12:52PM" Reply: "12:52pm" (No reply if GPIB-488)
Example (enhanced)	Cmd sent: "TIME? 12:52PM" Reply: "12:52pm"
Example (classic)	Sent: "TIME=12:52PM" Reply: "12:52pm"
Errors	ERR# 7: Missing or improper program message argument(s).
See Also	"DATE" 3.5.5.3

TP	
Purpose	To read the current target pressure.
Query	"TP?"
Classic	"TP"
Remarks	The current target pressure is replied in the current pressure unit of measure.
Example (enhanced)	Query sent: "TP?" Reply: "10.000 MPa a"
Example (classic)	Sent: "TP" Reply: "10.000 MPa a"
See Also	"PS" 3.3.10

TPCCFG (planned command as of PPCH Ver. 1.01f)	
Purpose	Start or check the status of a volume determination (TPC configuration).
Command	"TPCCFG n"
Query	"TPCVOL?"
Classic	"TPCCFG=n" "TPCCFG"
Arguments	n: '0' Abort a previously started volume determination routine '1' Start a new volume determination routine
Remarks	The PPCH volume routine takes 1 to 3 minutes to wait for stability and to determine the volume of the system into which the PPCH is controlling pressure. During this period, any other commands other than a query may abort this routine. The query form will reply the current volume if a previously started volume determination has completed or "BUSY" if a volume determination is still running. Pressure must be at least 1 MPa (150 psi) for the volume determination routine to run.
Example (enhanced)	Cmd sent: "TPCCFG 1" Reply: "1" (No reply if GPIB-488)
Example (enhanced)	Cmd sent: "TPCCFG?" Reply: "BUSY" (volume determination is running) "220 cc" (volume determination is complete)
Example (classic)	Sent: "TPCCFG=1" Reply: "TPCCFG=1"
Errors	ERR# 6: The argument was other than a '0' or a '1' (reply to a command only) ERR# 54: The pressure is below the minimum of 1 Mpa (reply to a command only) ERR# 22: The pressure is not stable enough (reply to query only)
See Also	"ABORT" 3.5.7.1

TPCVOL	
Purpose	Read or set the current estimate of test volume.
Command	"TPCVOL <i>n</i> "
Query	"TPCVOL?"
Classic	"TPCVOL= <i>n</i> " "TPCVOL"
Arguments	<i>n</i> : The volume of the system connected to the PPCH TEST port in cm ³ (cc) Must be 0 – 1 000 cc
Default	"TPCVOL 10"
Remarks	This current volume that the PPCH believes is connected to its TEST port can be read back or overridden using this command. The volume should be set only in automated conditions, where the test volume is constant and the configuration does not change. This volume is only an approximate value that may be adjusted empirically for correct operation. A higher setting speeds up pressure generation with a higher risk of significant control overshoot. A lower setting slows down pressure generation and reduces overshoot
Example (enhanced)	Cmd sent: "TPCVOL 50" Reply: "50" (No reply if GPIB-488)
Example (enhanced)	Cmd sent: "TPCVOL? 50" Reply: "50"
Example (classic)	Sent: "TPCVOL=50" Reply: "50"
Errors	ERR# 6 The volume was invalid.
See Also	5.7

UCOEF	
Purpose	To convert 1 Pascal to the current pressure units.
Query	"UCOEF?"
Classic	"UCOEF"
Remarks	The PPCH handles all pressure values internally in Pascal. The coefficient replied is equivalent of 1 Pa in the current pressure unit of measure. This program message allows the user to convert pressures. The reply will be in scientific notation if very small or very large.
Example (enhanced)	Query sent: "UCOEF?" Reply: "0.001000"
Example (classic)	Sent: "UCOEF" Reply: "0.001000"
See Also	3.3.2, 3.5.6, 7.2.1

UDU	
Purpose	Read or set the user defined pressure unit.
Command	"UDU <i>label, ucoef</i> "
Query	"UDU?"
Classic	"UDU= <i>label, ucoef</i> " "UDU" <i>label</i> : User unit label (4 alphanumeric char maximum). It cannot be an already supported unit label. <i>ucoef</i> : "User unit conversion coefficient (units/Pa).
Default	"UDU USER,1.0"
Remarks	The user defined unit must be set up with the program message prior to remote or local selection.
Example (enhanced)	Cmd Sent: "UDU MYUN, .001" Reply: "MYUN, 0.001000" (No reply if GPIB-488)
Example (enhanced)	Cmd Sent: "UDU? MYUN, .001" Reply: "MYUN, 0.001000"
Example (enhanced)	Sent: "UDU=MYUN, .001" Reply: "MYUN, 0.001000"
See Also	3.5.6, 3.3.2

UL	
Purpose	Read or set an upper limit for the current range.
Command	"UL <i>n</i> "
Query	"UL?"
Classic	"UL= <i>n</i> " "UL"
Arguments	<i>n</i> : The upper limit pressure in the current pressure unit and measurement mode.
Remarks	The PPCH has an upper limit for each range and for each measurement mode (gauge and absolute). New automated pressure control targets cannot be greater than this value. If the pressure does exceed the upper limit, the pressure display flashes, and pressure control stops. Manual increases in pressure are not allowed as long as the pressure is above the upper limit. Decreases in pressure are allowed. This feature should always be used to prevent accidental over pressure of a device under test.
Example (enhanced)	Cmd sent: "UL 10" Reply: "10.000 MPa a" (No reply if GPIB-488)
Example (enhanced)	Cmd sent: "UL? 10" Reply: "10.000 MPa a"
Example (classic)	Sent: "UL=1000" Reply: "10.000 MPa a"
Errors	ERR# 6: The argument is out of range.
See Also	3.4.4

UNIT	
Purpose	Read or set the pressure unit of measure unit and measurement mode.
Command	"UNIT <i>unit</i> (<i>, ref</i>)" "UNIT <i>unitg</i> (<i>, ref</i>)" "UNIT <i>unita</i> (<i>, ref</i>)"
Query	"UNIT?"
Classic	"UNIT= <i>unit</i> (<i>, ref</i>)" "UNIT= <i>unitg</i> (<i>, ref</i>)" "UNIT= <i>unita</i> (<i>, ref</i>)" "UNIT"
Arguments	<i>unit</i> : The text corresponding to the pressure unit of measure. <i>ref</i> : The optional unit reference temperature only if the unit is "InWa".
Remarks	This program message determines what unit of measure and may determine what measurement mode is used to display pressure values. Refer to Table 16 for a detailed list of the units available and their labels. The unit text must be followed by 'a' if absolute measurement mode is desired, or 'g' to specify gauge measurement mode. There can be a space between the unit text and the 'a' or the 'g'. If neither 'a' nor 'g' is specified, the unit will change but the measurement mode will remain the same. If the unit specified is "InWa", an optional second argument " <i>ref</i> " can be set. The " <i>ref</i> " can be 4, 20, or 60 corresponding to InWa at 4 °C, 20 °C or 60 °F. If this second argument is not given when the unit is "InWa", then the reference temperature is assumed to be 20 °C. The fifth character of the reply is always 'a' for absolute mode, or 'g' for gauge mode. White spaces will proceed this character if needed. The temperature reference is added to the reply only if the unit is "InWa".
Example (enhanced)	Cmd sent: "UNIT kPaa" Reply: "kPaa" Sent: "UNIT InWag, 4" Reply: "inWag, 4"
Example (classic)	Sent: "UNIT=kPaa" Reply: "kPa a" Sent: "UNIT=InWag, 4" Reply: "inWag, 4"
Errors	ERR# 7: The <i>unit</i> is invalid. ERR# 6: The <i>ref</i> is invalid.
See Also	"MMODE", "MODE" 3.3.2, 3.3.3

VENT	
Purpose	Read, execute or abort a vent process.
Command	"VENT <i>n</i> "
Query	"VENT?"
Classic	"VENT= <i>n</i> " "VENT"
Arguments	<i>N</i> : '1' to start a vent process. '0' to abort a vent process and close the exhaust valve.
Remarks	The PPCH vents by setting pressure close to atmospheric and then opening the exhaust valve. This program message query returns a '1' if the vent process is complete and the exhaust valve is opened, or a '0' if the exhaust valve is closed or if the vent process is not complete. A "PS=0" command will also execute the vent function.
Example (enhanced)	Cmd sent: "VENT 1" Reply: "0" (if not finished venting) (No reply if GPIB-488) "1" (if completely vented) (No reply if GPIB-488)
Example (enhanced)	Cmd sent: "VENT? 1" Reply: "0" (if not finished venting) "1" (if completely vented)
Example (classic)	Sent: "VENT=1" Reply: "VENT=0" (if not finished venting) "VENT=1" (if completely vented)
Errors	ERR# 6: The argument is not a '0' or a '1'.
See Also	"PS" 3.1.3, 3.3.10.6

VER	
Purpose	Identify the PPCH, US or SI units, the RPT labels and the software version.
Query	"VER?"
Classic	"VER"
Remarks	The software version of the PPCH can be read. This is useful for checking for the presence of the PPCH and for reference purposes. It indicates the internal RPT(s) and software version.
Example (enhanced)	Query sent: "VER?" Reply: "DH INSTRUMENTS, A FLUKE COMPANY PPCH us A100M/A20M Ver1.00" " (US version)
Example (classic)	Query sent: "VER?" Reply: "DH INSTRUMENTS, A FLUKE COMPANY PPCH si A100M/A20M Ver1.00" " (SI version)

ZOFFSET<i>n</i>	
Purpose	Read or set the AutoZ pressure offset (P_{offset}) for the specified RPT.
Command	"ZOFFSET <i>n</i> <i>GaOffset</i> , <i>AbsOffset</i> "
Query	"ZOFFSET <i>n</i> ?"
Classic	"ZOFFSET <i>n</i> = <i>GaOffset</i> , <i>AbsOffset</i> " "ZOFFSET <i>n</i> "
Defaults	"ZOFFSET <i>n</i> = 0.0, 0.0" (Gauge Q-RPT) "ZOFFSET <i>n</i> = 101325, 0.0" (Absolute Q-RPT)
Optional Suffix	" <i>n</i> " The active Q-RPT is assumed if no suffix is given. '1' Specify the Hi Q-RPT '2' Specify the Lo Q-RPT
Arguments	<i>GaOffset</i> The RPT pressure offset ("Poffset") for Gauge measurement mode (Pa). <i>AbsOffset</i> : The RPT pressure offset for absolute measurement mode (Pa)
Remarks	The pressure offset (P_{offset}) for the specified RPT (Hi or Lo) can be accessed with this program message. There is a separate offset for gauge and absolute measurement modes. Gauge RPTs do not support "AbsOffset". External RPT P_{offset} cannot be adjusted from the PPCH. Using this program message will overwrite the current offset, so caution must be used. Changes made using this program message take effect immediately.
Example (enhanced)	Cmd sent: "ZOFFSET1 2.1, 0" Query reply: " 2.100 Pa, 0.000 Pa"
Example (classic)	Sent: "ZOFFSET=97293.1, 3.02" Reply: " 97293.100 Pa, 3.020 Pa"
Errors	ERR# 6: One of the arguments is out of range.
See Also	3.5.1

ZOFFSET:IH and ZOFFSET:IL (obsolete style)	
Purpose	Read or set the AutoZ pressure offset (P_{offset}) for the high ("IH") or low ("IL") RPT and current measurement mode. Not recommended for new applications
Command	"ZOFFSET:IH <i>offset</i> " "ZOFFSET:IL <i>offset</i> "
Query	"ZOFFSET:IH?" "ZOFFSET:IL?"
Classic	"ZOFFSET:IH = <i>offset</i> " "ZOFFSET:IL = <i>offset</i> " "ZOFFSET:IH" "ZOFFSET:IL"
Defaults	"ZOFFSET:IH = 0.0" "ZOFFSET:IL = 0.0"
Arguments	<i>offset</i> : The RPT pressure offset ("Poffset") for the current measurement mode (gauge or absolute) in Pa.
Remarks	The pressure offset (P_{offset}) for the specified RPT (HI or Lo) in the current measurement mode can be accessed with this program message. External RPTs' P_{offset} cannot be adjusted from PPCH. There is a separate offset for gauge and absolute measurement modes. Using this program message will overwrite the current offset, so caution must be used. Changes made using this program message take effect immediately.
Example (enhanced)	Cmd sent: "ZOFFSET:IL 32.1" Reply: " 32.10 Pa"
Example (classic)	Sent: "ZOFFSET:IL=32.1" Reply: " 32.10 Pa"
Errors	ERR# 6: One of the arguments is out of range.
See Also	3.5.1

4.5 STATUS REPORTING SYSTEM

The PPCH status reporting system is used to track and report system status and errors. It follows the model of the IEEE Std 488.2 and works for the COM1 and the IEEE-488 port with slight differences. The PPCH can be programmed to respond to various status conditions by asserting the SRQ of the IEEE-488 interface. The COM1 port cannot be supported in such a way, so polling must be used.

4.5.1 ERROR QUEUE

The PPCH keeps track of remote errors by using an error queue. If an error occurs, it is pushed onto the Error Queue. If you are using the COM1 port, the error number is immediately replied in the form "ERR#nn where nn is the error code from 0 to 99. The "ERR?" (or "ERR") query can then be used to pull the error from the Error Queue in it's descriptive text format. If you are using the enhanced program message format, the Error Queue will accumulate errors until full unless they are pulled from the queue. If you are using the classic program format, the Error Queue is cleared every time a new program message is received.

4.5.2 STATUS BYTE REGISTER

The PPCH contains an 8 bit Status Byte Register that reflects the general status of the PPCH.

Table 21. 8 Bit status byte register

OPER	RQS/MSS	ESB	MAV	N/A	ERROR	N/A	RSR
(128)	(64)	(32)	(16)	(8)	(4)	(2)	(1)

This register is affected by the PPCH reply output queue, the Error Queue, the Standard Event Status register and the *Ready Event* Status register.

Status Byte Register

(*STB? or *SRE n)

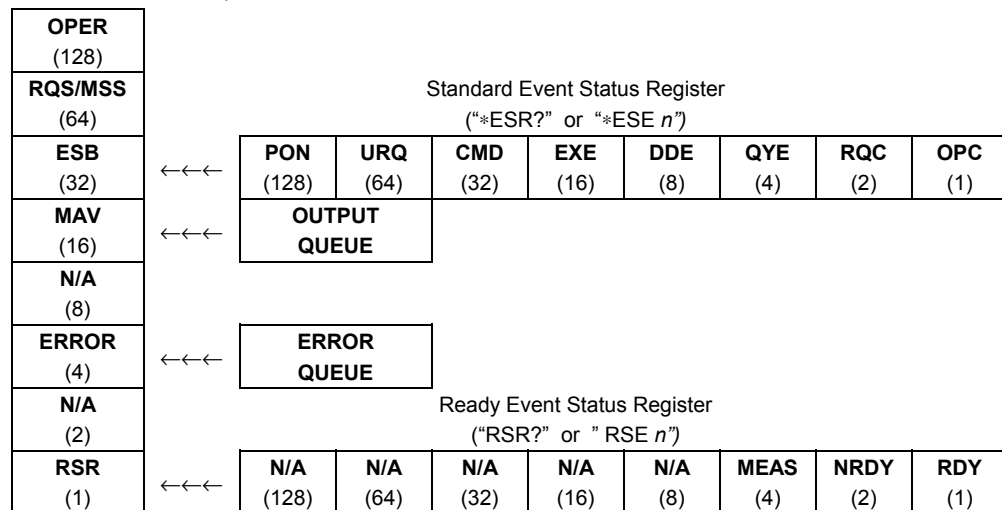

Figure 18. Status register schematic

The Status Byte Register can be read using the ****STB?** query, or by performing a serial poll on the IEEE-488 bus. If you read this using a serial poll then Bit 6 is the RQS. If the ****STB?** query is used, then bit 6 is the MSS bit. All of the other bits are common to both types of query.

Each of these status bits can cause a SRQ to occur. The Service Request Enable Register (****SRE** program message) determines which of these flags are able to assert the SRQ line. This enable register has a matching set of bits that each will enable the designated bit to cause a SRQ, except for the RQS/MSS bit(s) which cannot cause a SRQ. If you set this register to 20 (\$14 hex), an SRQ will occur if the MAV or the ERROR bit are set. The description of these bits are given as:

OPER N/A Bit 7 (128)

RQS Requested Service Bit 6 (64)

Indicates that the SRQ line of the IEEE-488 interface has been asserted by the PPCH. This bit is cleared when a serial poll is performed on the PPCH, and is a part of the Status Byte Register when read using a serial poll. This bit does not apply if the COM1 port is being used.

MSS Master Summary Status Bit 6 (64)

Indicates that an event or events occurred that caused the PPCH to request service from the Host, much like the RQS bit. Unlike the RQS bit, it is READ ONLY and can be only cleared when the event(s) that caused the service request are cleared.

ESB Event Summary Bit 5 (32)

Indicates if an enabled bit in the Standard Event Status Register became set (see Section 4.5.3).

MAV Message Available Bit 4 (16)

Indicates that at least one reply message is waiting in the PPCH IEEE-488 output queue.

ERROR Error Queue Not Empty Bit 2 (4)

Indicates that at least one command error message is waiting in the PPCH IEEE-488 error message queue. Use the ****ERR?** query to get this message.

RSR Ready Summary Bit 0 (1)

Indicates that an enabled bit in the Ready Status Register became set.

4.5.3 STANDARD EVENT REGISTER

The PPCH contains an 8 bit Standard event register that reflects specific PPCH events. Enabled events in this register will set or clear the ESB bit of the Status Byte Register.

Table 22. 8 bit standard event register

PON	URQ	CMD	EXE	DDE	QYE	RQC	OPC
(128)	(64)	(32)	(16)	(8)	(4)	(2)	(1)

This register can be read using the “*ESR?” query, Each of these status bits can set the ESB bit of the Status Byte Register, causing a SRQ to occur IF the ESB bit is enabled to do so. The Standard Event Status Enable Register (“*ESE” program message) determines which of these flags are able to assert the ESB bit. The description of these bits are given as:

- PON** Power On (Bit 7)
Indicates that the PPCH power has been cycled since the last time this bit was read or cleared.
- URQ** User Request (Bit 6)
Indicates that the PPCH was set to local operation manually from the front panel by the user (pressing the **[ESC]** key).
- CMD** Command Error (Bit 5)
Indicates that a remote command error has occurred. A command error is typically a syntax error in the use of a correct program message.
- EXE** Execution Error (Bit 4)
Indicates if a remote program message cannot be processed due to device related condition.
- DDE** Device Dependent Error (Bit 3)
Indicates that an internal error has occurred in the PPCH such as a transducer time-out.
- QYE** Query Error (Bit 2)
Indicates that an error has occurred in the protocol for program message communications. This is typically caused by a program message being sent to the PPCH without reading a waiting reply.
- RQC** Request Control (Bit 1)
This bit is not supported as the PPCH cannot become the active controller in charge.
- OPC** Operation Complete (Bit 0)
Indicates that the PPCH has completed all requested functions.

4.5.4 READY STATUS REGISTER

The PPCH contains an 8 bit Ready Status Register that reflects specific PPCH measurement and generation ready events. Enabled events in this register will set or clear the RSB bit of the Status Byte Register.

Table 23. 8 bit ready status register

N/A	N/A	N/A	N/A	N/A	MEAS	NRDY	RDY
(128)	(64)	(32)	(16)	(8)	(4)	(2)	(1)

This register can be read using the “*RSR?” query, Each of these status bits can set the RSB bit of the Status Byte Register, causing a SRQ to occur IF the RSB bit is enabled to do so.

The Standard Event Status Enable Register (“*RSE” program message) determines which of these flags are able to assert the RSB bit. The description of these bits are given as:

MEAS	Measurement ready (Bit 2) Indicates that the PPCH has completed a Q-RPT measurement.
NRDY	Generation Not Ready (Bit 1) Indicates that the PPCH made a transition from <i>Ready</i> to <i>Not Ready</i> as defined by the control settings (see Section 3.2.2).
RDY	Generation Ready (Bit 0) Indicates that the PPCH has reached a target pressure and is <i>Ready</i> as defined by the control settings (see Section 3.2.2).

4.6 IEEE STD. 488.2 COMMON AND STATUS PROGRAM MESSAGES

The PPCH supports a set of commands that are common to all instruments conforming to IEEE Std. 488.2. These command make it easy to perform basic function for any device that supports these commands. These commands also cover the status reporting commands. See Section 4.5 for details on the status registers mentioned in these commands.

Table 24. Program message list

*CLS	Clear all of the status & event structures.
*ESE	Read or set the Standard Event Status Enable Register.
*ESR	Read the Standard Event Status Register.
*IDN	Identify the PPCH version, range, and serial number.
*OPC	Set the operation complete bit when all operations have completed.
*OPT	Read the list of installed PPCH options.
*RST	Reset the PPCH control settings to factory settings.
*TST	Read the power on self test status.
*SRE	Read or set the Service Request Enable Register.
*STB	Read the Status Byte Register.
*RSE	Read or set the Ready Status Enable Register.
*RSR	Read the Ready Status Register.

4.6.1 PROGRAM MESSAGE DESCRIPTIONS

*CLS	
Purpose	Clear all of the status & event structures.
Command	“*CLS”
Remarks	This program message clears the following events and status registers: Standard Byte Register (STB) Standard Event Status Register (ESR) Error Queue Pending OPC operations
Example (classic)	Sent: “*CLS” Reply: none

*ESE	
Purpose	Read or set the Standard Event Status Enable Register.
Command	"*ESE n"
Query	"*ESE?"
Default	"*ESE 0"
Arguments	n: '0 to 255' This is the decimal representation of the bit(s) to enable. To enable the PON and QYE bits, the argument would be 128 + 4 = 132.
Remarks	The Standard Event Status Enable register determines which bits in the standard Event Status Register are enabled and included in the Status Byte Register (ESB bit), and can assert the SRQ line. The reply is in decimal numeric form.
Example (enhanced)	Sent: "*ESE=128"(enables the PON bit) Reply: "128" (no reply if IEEE-488)
Errors	ERR# 6: n is not valid.

*ESR	
Purpose	Read the Standard Event Register.
Command	"*ESR?"
Remarks	The Standard Event Register contents are cleared after reading. The reply is in decimal numeric form.
Example (enhanced)	Sent: "*ESR?" Reply: "20" (the QYE and EXE bits are set)

*IDN	
Purpose	Identify the PPCH version, range, and serial number.
Query	"*IDN?"
Remarks	The identification reply is made up of the manufacture, the model, the serial number and the software version. Each is separated by a comma.
Example (enhanced)	Sent:"*IDN?" Reply:DH INSTRUMENTS INC, PPCH, 1,35785,0, Ver1.00 -kkbj"

*OPC	
Purpose	Sets the operation complete bit when all operations have completed.
Command	"*OPC"
Query	"*OPC?"
Remarks	This Command enables the PPCH to set the OPC bit in the Standard Event Status Register when it has completed all pending functions. The Query replies with a "1" when all functions are complete.
Example (enhanced)	Sent: "*OPC" Reply: "1"

*OPT	
Purpose	Reads the list of installed PPCH options.
Query	"*OPT?"
Remarks	This Query returns any registered option(s) installed in the PPCH. Each option is separated by a comma. Possible options: "IEEE-488:0" The IEEE-488 option is installed. "ANALOG:n" The analog option is installed. 'n' is the revision on the analog option hardware from 'A' to 'Z' or '-' if original revision.
Example (enhanced)	Sent: "*OPT?" Reply: "IEEE-488:0, ANALOG:-"

*RST	
Purpose	Resets the PPCH control settings to factory settings.
Command	"*RST"
Remarks	This Command sets the PPCH settings to factory settings. This equivalent to a front panel executed RESET/SET. This does not affect the communications settings.
Example (enhanced)	Sent: "*RST" Reply: "*RST" (no reply if IEEE-488)
See Also	3.5.4.1

*SRE	
Purpose	Read or set the Service Request Enable Register.
Command	"*SRE <i>n</i> "
Query	"*SRE?"
Default	"*SRE 0"
Arguments	<i>n</i> : '0 to 255' This is the decimal representation of the bit(s) to enable. To allow the MAV and ESB bits to assert the SRQ line, the argument would be 32 + 16 = 48. Bit 6 (64) is reserved and cannot be set.
Remarks	The Service Request Enable Register determines which bits of the Status Byte can set the MSS bit of the Status Byte and request service by asserting the SRQ line of the IEEE-488 interface.
Example (enhanced)	Sent: "*SRE=48" (enables the MAV and ESB bits) Reply: "48" (no reply if IEEE-488)
Errors	ERR# 6: <i>n</i> is not valid.

*STB	
Purpose	Read the Status Byte Register.
Command	"*STB?"
Remarks	The Status Byte Register reflects the general status of the PPCH. The 'MSS' bit state is represented by bit 6.
Example (enhanced)	Sent: "*STB?" Reply: "80" (The MSS and MAV bits are set)

*TST	
Purpose	Read the power on self test status.
Query	"*TST?"
Remarks	The PPCH system memory stores the user settings (units, resolution, generation settings) and retains them when the unit is OFF. On power-up, this memory is checked. If this memory is corrupted, all user settings are reset to default (as if the "*RST" program message was executed), and the *TST query will return a non zero value. If the PPCH passed the test on power-up OR if the *TST query was used at least once since the PPCH was powered up the reply will be a '0'.
Example (enhanced)	Sent: "*RST?" Reply: "1"

*RSE	
Purpose	Read or set the Ready Status Enable Register.
Command	"RSE <i>n</i> "
Query	"RSE?"
Default	"RSE 0"
Arguments	<i>n</i> : '0 to 255' This is the decimal representation of the bit(s) to enable. To enable the RDY bit, the argument would be 1.
Remarks	The Ready Status Enable Register determines which bits in the Ready Status Register are enabled and included in the Status Byte Register (RSR bit), and can assert the SRQ line. The reply is in decimal numeric form.
Example (enhanced)	Sent: "*RSE=1" (enables the RDY bit) Reply: "1" (no reply if IEEE-488)
Errors	ERR# 6: <i>n</i> is not valid.

*RSR	
Purpose	Read the Ready Status Register.
Command	"RSR?"
Remarks	The Ready Status Register contents are cleared after reading. The reply is in decimal numeric form.
Example (enhanced)	Sent: "RSR?" Reply: "6" (The MEAS and NRDY)

NOTES

5. MAINTENANCE, ADJUSTMENTS AND CALIBRATION

5.1 OVERVIEW

For PPCH to operate reliably and within specifications over time, regular maintenance and calibration are required.

Routine preventive maintenance is recommended yearly or every 2 000 hours of high pressure operation (see Section 5.2). Section 5.2 also includes a table of parts used in maintenance procedures.

Calibration of Q-RPTs or utility transducer is recommended annually (see Section 5.3, 5.5).

Other procedures should be performed as needed. These include:

- Rezeroing of quartz reference pressure transducers (Q-RPT) or utility sensor, if present (see Section 3.5.1).
- Automated adjustment of pressure controlling parameters (see Sections 5.7, 5.8).
- Replacing pressurized fluid (see Section 5.6).
- Priming the hydropneumatic pump (see Section 5.10.1).

Certain operational problems or failures can be diagnosed and corrected locally. To troubleshoot PPCH operation based on behavioral symptoms and identify procedures to correct them, see the troubleshooting guide in this manual (Section 6).



PPCH is a sophisticated pressure setting and measuring instrument with advanced on-board features and functions. Before assuming that unexpected behavior is caused by a system defect or breakdown, use this manual and other training facilities to become thoroughly familiar with PPCH operation. For rapid assistance in specific situations use the troubleshooting guide in Section 6.



PPCH is covered by a limited one (1) year warranty. Unauthorized service or repair during the warranty period is undertaken at the owner's risk and may cause damage that is not covered under warranty and/or may void the warranty. See Section 8.

5.2 PREVENTIVE MAINTENANCE



Preventive maintenance should be performed once a year or every 2000 hours of high pressure operation, as measured by the PPCH on-board timer (see Section 3.5.7.3.4).



If calibration of the reference pressure transducers (Q-RPT) is included as part of the overhaul procedure, the calibration procedure should be performed last.

See Table 25 for a list of parts used in PPCH maintenance.

Regular preventive maintenance should include, in order, the following :

- Check that the electronic module rear panel cooling fan (top rear) operates when PPCH is ON. Replace if necessary.
- Visually inspect internal mechanical system (see Section 5.9). Look for accumulated oil which can indicate a leaking internal component or evidence of oil misting which indicates the need for hydropneumatic pump replacement.
- Verify that internal barometer reads atmospheric pressure, ± 0.1 kPa (0.015 psi). Adjust if necessary (see Section 5.4).
- Verify that utility sensor, if present, indicates the correct pressure within ± 0.1 % FS over its range. Adjust if necessary (see Section 5.5).
- Verify that pump pressure transducer indicates correctly (see Section 3.5.7.3). Use **[SPECIAL]**, **<7internal>**, **<3pump>**, **<3pressure>** to view the measured pump pressure. Remove and apply the pressure while reading the pressure to determine whether the pump pressure transducer is responding properly and if the measured pressure is within $\pm 1\%$.
- Check that all internal screws, bolts and nuts are tight. Tighten as necessary.
- Leak test the PPCH (see Section 5.11.1). Leak rate, after stabilization, should not exceed 0.002 % of reading/ second.
- If leak check fails, replace isolation or vent valve(s) if needed (see Section 5.11.2).
- Drain, flush and replace fluid in reservoir (see Section 5.6).
- Replace pump supply inlet filter (liquid) if the test fluid in the reservoir is not perfectly clear (see Section 5.10.4).
- Flush external line filter connected to PPCH **TEST** port, if present (see Section 2.3.9.1).
- Replace or maintain hydropneumatic pump (see Section 5.10.2).
- Prime system and hydropneumatic pump (see Section 5.10.1).
- Check the PPCH controls within specifications over its range (see Section 1.2.3).
- Perform calibration of Q-RPTs (see Section 5.3).

Table 25. PPCH maintenance parts

PART	DESCRIPTOR	P/N	DESCRIPTION
valve	dome, isolation, high P	402171	High pressure vent valve, low pressure isolation valve, low pressure vent valve
filter or filter kit	15m, SS, 1/4 SWG	102808	Pump supply filter (liquid)
		3401429	Filter with pre-attached extension tube
repair kit	spool valve, PP189, -2	101891	Kit to repair hydropneumatic pump spool valve (all models)
fluid	Sebacate, 1 qt	400503	Standard hydraulic fluid for PPCH. Other fluids not supplied by DHI.
fluid	Sebacate, 1 gal	401114	
pump, new	air driven, PP189	402405	New replacement pump for PPCH-70M, -100M
pump, new	air driven, PP189-2	402404	New replacement pump for PPCH-140M, -200M
pump, recon	air driven, PP189	402402	Reconditioned replacement pump for PPCH-70M, -100M
pump, recon	air driven, PP189-2	402401	Reconditioned replacement pump for PPCH-140M, -200M

5.3 CALIBRATION OF QUARTZ REFERENCE PRESSURE TRANSDUCERS (Q-RPTS)

5.3.1 PRINCIPLE

PPCH may be equipped with one or two quartz reference pressure transducers (Q-RPTs) that are the source of low uncertainty pressure measurement for the system.

To calibrate a Q-RPT, pressures from a standard are applied to the Q-RPT at ascending and descending points over the range. The pressure defined by the standard and the corresponding Q-RPT readings are recorded at each point. After all of the pressures have been applied and recorded, adjustments are made to fit the Q-RPT pressure readings to the standard. Fitting the readings means performing a linear regression to arrive at the lowest value of the residuals of errors of the Q-RPT relative to the standard. The Q-RPT output is adjusted by user settable coefficients: PA (an adder or offset) and PM (a multiplier or span adjustment) (see Section 5.3.1.1).

The calibration process is performed independently on each Q-RPT to arrive at its optimal fit.

When running calibrations, collecting as received data and calculating PA and PM adjustments, whether AutoZ is normally used, whether it is ON or OFF and what the value of Zoffset is should be considered (see Section 3.5.1, ○ PRINCIPLE).



CalTool for RPTs software provided with the PPCH supports the calibration process of PPCH Q-RPTs. CalTool and its documentation are provided on a General Accessories Disk with the new PPCH. Most users should use CalTool software to assist in the calibration of PPCH.

PPCH is delivered with an interactive Q-RPT calibration utility that steps the operator through the complete Q-RPT calibration procedure including applying the necessary pressures, collecting data automatically, calculating new PA and PM values, previewing the results of the new calibration and activating the results of the new calibration (see the CalTool for RPTs manual on the General Accessories Disk). PPCH also provides complete front panel and remote access to Q-RPT calibration parameters so that Q-RPT calibrations can be performed without using CalTool software (see Section 5.3.8).



PPCH may also use external Q-RPTs mounted in RPM4 Reference Pressure Monitors. RPM4 Q-RPTs are calibrated independently of PPCH (see the RPM4 Operation and Maintenance Manual).

5.3.1.1 PA AND PM COEFFICIENTS

The coefficients used to adjust Q-RPT readings are designated PA (an adder or offset) and PM (a multiplier or span set). The coefficients affect the Q-RPT reading following:

$$\text{Corrected reading} = (\text{uncorrected reading} \cdot \text{PM}) + \text{PA}$$

PA is expressed in units of pressure (always the SI unit, Pascal).

PM is dimensionless.

Each Q-RPT has its own unique PA and PM values. The PA and PM values currently in use can be viewed and edited in the CAL function (see Section 5.3.7). PA and PM values are automatically edited when CalTool software is used and the results are activated.



As editing PA and PM values will change Q-RPT calibration, they should only be edited by qualified personnel as part of the calibration process. Caution should be taken to avoid accidental editing and a security system is available to prevent access (see Section 3.5.5.5). Incorrect editing of PA and PM values can cause out of tolerance measurements.



A new PPCH is delivered with PA and PM values set to zero and 1 for all ranges. This does not mean that the PPCH has not been calibrated. In the original factory calibration, privileged factory coefficients are used for calibration with the user PA and PM set to zero and 1.

5.3.1.2 AS RECEIVED AND AS LEFT DATA

Frequently, calibration procedures require that as received and as left data be reported. The necessary information to report as received and as left data on the calibration of PPCH Q-RPTs can be obtained in several ways.

When the PPCH CalTool calibration assistance software is used, as received data is displayed while running the calibration and is automatically recorded and provided if desired. As left data is also calculated and presented.

At any time, a) reference pressures applied, b) associated Q-RPT readings, c) PA, PM and P_{offset} values can be used to calculate as received and as left values. For example, backing out PA and PM on the as left data yields the transducer readings with PA = 0 and PM = 1. Then applying the as received PA and PM and P_{offset} values to the readings calculates *as received* readings (the readings that the transducer would have made with the old PA, PM and P_{offset}).



A new PPCH is delivered with PA and PM values set to zero and 1 for all ranges. This does not mean that the PPCH has not been calibrated. In the original factory calibration, privileged factory coefficients are used for calibration with the user PA and PM set to zero and 1.



It is recommended that “as received” values of PA, PM and P_{offset} (P_{offset} for absolute mode calibrations if AutoZero is used in normal operation) be recorded for each range prior to running the calibration. The current PA and PM and absolute mode P_{offset} can be viewed by pressing [SPECIAL], <Bcal>, <1view>.



A new PPCH is delivered with PA and PM values set to zero and 1 for all ranges. This does not mean that the PPCH has not been calibrated. In the original factory calibration, privileged factory coefficients are used for calibration with the user PA and PM set to zero and 1.

5.3.2 EQUIPMENT REQUIRED



The recommended calibration standards for PPCH Q-RPTs is a DHI PG7302 oil operated piston gauge or a PG7202 gas operated piston gauge depending on the range and fluid of the PPCH. An interfacing method must be used if the operating medium of the PPCH is not Sebacate oil. Contact DHI for additional information.

Piston gauge (deadweight tester), with the following characteristics:

- **Measurement uncertainty of ± 0.008 % of reading or better.** A standard with higher measurement uncertainty may be used but PPCH measurement uncertainty may be degraded proportionally from published specifications.
- **If the Q-RPT will be used in the absolute measurement mode, the reference must be able to apply absolute pressures:** In the range of pressure covered by PPCH, absolute pressures are usually defined by adding atmospheric pressure measured by a barometer to gauge pressure defined by a piston gauge. **PPCH Q-RPTs that will not be used in absolute measurement mode may be calibrated using a gauge pressure only.**



PPCH Q-RPTs calibrated in gauge measurement mode by applying gauge reference pressure values should be used in gauge mode only (see Sections 3.3.3 ○ PRINCIPLE, 5.3.5).

- **Able to supply the recommended sequence of pressure points in the range to be calibrated:** See Section 5.3.4 for information on the recommended calibration point sequence for PPCH Q-RPTs.

5.3.3 SET UP AND PREPARATION

To set-up and prepare the PPCH for calibration of an internal Q-RPT:

- 1 Set the PPCH on a stable surface near the calibration standard at a height as close as possible to the calibration standard's reference height. Consider the connections that may need to be made to the rear panel and access to the front panel display and keypad.
- 2 Connect the calibration standard output to the PPCH rear panel TEST port (DH500 F).



DH500 is a gland and collar type fitting for 1/4 in. (6.35 mm) coned and left hand threaded tube. DH500 is equivalent to AE F250C, HIP HF4, etc. **DO NOT USE INCORRECT FITTINGS; DAMAGE TO THE FITTING AND DANGER TO THE OPERATOR COULD RESULT.**

- 3 Turn OFF the PPCH VENT (see Section 3.1.3).

5.3.4 RECOMMENDED CALIBRATION POINT SEQUENCE

Calibration adjustments to PPCH Q-RPTs are made by adjusting calibration coefficients, PA and PM (see Section 5.3.1.1). To adjust these coefficients to optimum values giving the best results over the Q-RPT's complete operating range, specific calibration point sequences are recommended.

Prior to running the calibration point sequence, the Q-RPT should be exercised by setting full scale pressure, dwelling at full scale pressure for 5 minutes, returning to atmosphere (vented), dwelling for twenty minutes.

A dwell time after setting the pressure of at least 90 seconds before taking data at each point is recommended.



It is not required that the calibration pressure standard apply precisely the nominal pressure value of each calibration point as long as the exact value of the applied pressure is known. Best results are obtained if the actual applied pressure is within 2 % of the nominal point definition.

Table 26. Calibration point sequence, standard class, Q-RPTs

CALIBRATION SEGMENT	POINT NO.	POINT [% OF SPAN]
Ascending	1	Lowest Pressure ¹
	2	25 %
	3	50 %
	4	75 %
	5	100 %
Descending	6	75 %
	7	50 %
	8	25 %
	9	Lowest Pressure ¹

1 In absolute mode, a point at or near atmospheric pressure. Zero (vented) in gauge mode.



PPCH Q-RPTs that will NOT be used in absolute measurement mode may be calibrated in gauge measurement mode with a gauge pressure standard. PPCH Q-RPTs calibrated in gauge measurement mode by applying gauge reference pressure values should be used in gauge mode only (see Section 5.3.5).

5.3.5 TURNING OFF ABSOLUTE MEASUREMENT MODE FOR A Q-RPT

○ PURPOSE

To prevent selection of absolute measurement mode for a Q-RPT.

○ PRINCIPLE

PPCH Q-RPTs are intrinsically absolute (Axxx type) but are frequently used in gauge measurement mode only (see Section 3.3.3 ○ PRINCIPLE). PPCH Q-RPTs that are used in gauge mode only, may be calibrated in gauge mode with a reference that applies gauge pressures. Calibration with an absolute reference is not necessary. However, if a PPCH Q-RPT is calibrated in gauge mode, it is not possible to know if it is in or out of tolerance in absolute mode. To avoid using absolute measurement mode on a Q-RPT that is calibrated for gauge mode only, access to absolute mode can be turned ON and OFF. This is accomplished in the [SPECIAL], <8cal> menu.

○ OPERATION



See Section 5.3.7 for more detailed information on editing and viewing Q-RPT calibration information. See Section 3.5.5.5 for information on the PPCH security system to prevent access to Q-RPT calibration editing.

Turning absolute mode operation ON and OFF for a Q-RPT occurs in the same area in which calibration coefficients are edited. To access the Q-RPT calibration editing area press [SPECIAL], <8cal> and select the desired Q-RPT. Then select <1edit> to make changes (see Section 5.3.7).

[ENT] through the calibration information. After viewing the values of PA and PM the display is:

Absolute mode:	HI
1off 2on	

The cursor is on the number corresponding to the current selection. Make the desired selection. <1off> causes absolute mode to be unavailable for the Q-RPT in normal measurement and control operation.



PPCH may also use external Q-RPTs mounted in RPM4 Reference Pressure Monitors. Viewing and adjustment of RPM4 calibration information is performed locally on the RPM4, not through PPCH (see the RPM4 Operation and Maintenance Manual).

5.3.6 Q-RPT CALIBRATION USING CALTOOL FOR RPTS SOFTWARE

To calibrate PPCH Q-RPTs using CalTool software, refer to Sections 5.3.1 ○ PRINCIPLE, 5.3.2, and 5.3.3 in this manual and then refer to the CalTool for RPTs Software Manual.

CalTool for RPTs software and manual are supplied on the PPCH General Accessories Disk (white CD) and can be downloaded from www.dhstruments.com.

5.3.7 EDITING AND VIEWING Q-RPT CALIBRATION INFORMATION

○ PURPOSE/PRINCIPAL

View and/or edit Q-RPT calibration information fields including:

- **The calibration date** – This field is normally used to record the date on which the Q-RPT is calibrated.
- **The value of absolute mode AutoZero P_{offset}** – See Section 3.5.1 for complete AutoZero information. This value is normally set to zero following absolute measurement mode calibration of a Q-RPT.
- **The value of PA** – The pressure adder for the selected Q-RPT (see Section 5.3.1.1).
- **The value of PM** – The pressure multiplier for the selected Q-RPT (see Section 5.3.1.1).
- **Absolute measurement mode ON or OFF** – See Section 3.3.3 ○ PRINCIPLE for complete information on measurement modes. This is set to OFF if the Q-RPT was calibrated in gauge mode with a gauge pressure standard (see Section 5.3.5) and absolute mode is not to be used.

○ OPERATION



As editing PA and PM values will change the calibration of the Q-RPTs, the edit function should only be used by qualified personnel as part of the calibration process. Caution should be taken to avoid accidental editing. A user level security system is available to control access (see Section 3.5.5.5).



A new PPCH is delivered with PA and PM values set to zero and 1 for all ranges. This does not mean that the PPCH has not been calibrated. In the original factory calibration, privileged factory coefficients are used for calibration with the user PA and PM set to zero and 1.

To access Q-RPT calibration information viewing or editing press **[SPECIAL]**, **<8Cal>**. Select the desired Q-RPT. The **<1view>** selection displays the calibration information fields. The **<2edit>** function displays the fields and allows them to be edited. The display is:

1. Date of last calibration in YYYYMMDD format.
2. Position designator of the Q-RPT being viewed.
3. Current value of absolute mode P_{offset} .

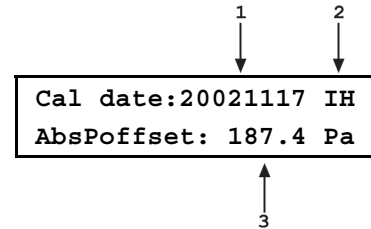

If in **edit** mode, the calibration information fields can be edited. Edits to P_{offset} are common with changes made in the AutoZ edit or run function (see Section 3.5.1). Pressing **[ENT]** on the last field goes to the next view/edit screen:

1. Value of PA.
2. Position designator of the Q-RPT being viewed.
3. Value of PM.

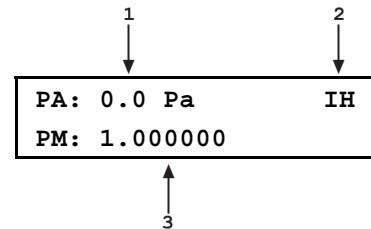

If in **edit** mode, the calibration fields can be edited. Pressing **[ENT]** in the PM field goes to the next calibration information display:

1. Position designator of the Q-RPT being viewed.
2. Cursor is on current YES or NO selection.

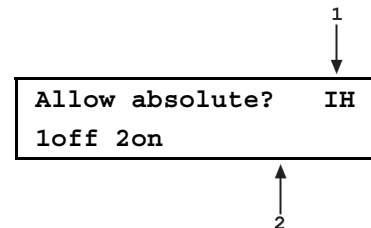

If in **edit** mode, the status can be changed by selecting **<1off>** or **<2on>** (see Section 5.3.5). **[ENT]** in view mode returns to the view/edit screen. **[ENT]** in edit mode goes to confirmation of change activation if changes have been made. Pressing **[ESC]** in any edit screen exits the edit screen without activating any changes.



The value of PA is always in Pascal (Pa). The value of PM is dimensionless.



PPCH may also use external Q-RPTs mounted in RPM4 Reference Pressure Monitors. Viewing and adjustment of RPM4 calibration information is performed locally on the RPM4, not through PPCH (see the RPM4 Operation and Maintenance Manual).

5.3.8 Q-RPT CALIBRATION/ADJUSTMENT WITHOUT CALTOOL FOR RPTS SOFTWARE

○ PRINCIPLE

The PPCH Q-RPTs can be calibrated and adjusted without using CalTool for RPTs software.

This requires:

- Applying pressures with a calibration standard and recording the pressures measured by PPCH.
- Calculating new PA and PM values and entering them.
- Setting P_{offset} to zero for Q-RPTs that will be used in absolute mode.



Before proceeding to calibrate a reference pressure transducer without using CalTool for RPTs software, Sections 5.3.1, 5.3.2 and 5.3.3 should be reviewed thoroughly.

○ OPERATION

The typical procedure for calibrating a Q-RPT is:

- 1 Set-up and prepare the PPCH for calibration (see Sections 5.3.2, 5.3.3).
- 2 Use the **[RPT]** function key to select the Q-RPT to be calibrated (see Section 3.3.5). Be sure to set the DF range (not an AutoRanged range).
- 3 Use **[HEAD]** to set the HEAD to zero (see Section 3.3.7). Use **[UNIT]** to set the desired pressure unit of measure (see Section 3.3.2). Use **[MODE]** to set the desired pressure measurement mode (see Section 3.3.3). PPCH Q-RPTs that will be used in gauge measurement mode only, may be calibrated in gauge measurement mode with a gauge pressure standard (see Section 5.3.5).
- 4 Use **[SPECIAL]**, **<1AutoZ>** to access the AutoZ function (see Section 3.5.1).

If calibrating in absolute measurement mode, turn AutoZ ON if it is left ON in normal PPCH operation. If calibrating in gauge measurement mode, always turn AutoZ ON.

- 5 Use **[SPECIAL]**, **<8cal>**, **<1Hi RPT>** or **<2Lo RPT>**, **<1view>**, to read and record the current values of PA and PM for the Q-RPT to be calibrated. If calibrating in absolute mode, also record the value of $P_{\text{offset, abs}}$.
- 6 Run the recommended calibration point sequence for the Q-RPT (see Section 5.3.4) recording the pressure applied by the standard and the PPCH reading at each calibration point. The data recorded is the “as received” data for this calibration.
- 7 Enter the calibration pressures and PPCH readings into a spreadsheet. Calculate the “non-corrected” PPCH readings by backing out the PA, PM and $P_{\text{offset, abs}}$ ($P_{\text{offset, abs}}$ is necessary only if the Q-RPT is being calibrated in absolute mode) recorded in Steps 4 and 5 above, following:

$$\text{non-corrected reading} = ((\text{corrected reading} - \text{PA})/\text{PM}) + P_{\text{offset, abs}}$$

- 8 Perform a linear regression to find the offset and slope that best fit the non-corrected PPCH readings to the calibration standard pressures. The offset is the new value of PA, the slope is the new value of PM.
- 9 Press **[SPECIAL]**, **<8Cal>**, **<1Q-RPT>**, **<2edit>** and write the new calibration date and the new values of PA and PM for the Q-RPT and range calibrated. If this is an Axxx Q-RPT used in absolute mode, edit the value of P_{offset} to zero. If this is an Axxx Q-RPT and the calibration was performed in gauge mode, turn absolute mode OFF so that it cannot be used after the calibration.

- ⑩ Calculate as left data for the calibration, if desired, following:

$$\text{as left reading} = (\text{non-corrected reading} \cdot \text{new PM}) + \text{new PA}$$

- ⑪ Perform additional verification pressure runs as desired.

5.4 ADJUSTMENT OF ON-BOARD BAROMETER

○ PURPOSE

To adjust the output of the on-board barometer (see Section 1.2.2.3, 5.14.1.5).

○ PRINCIPLE

The on-board barometer output can be adjusted using PA and PM values in the same manner as Q-RPTs (see Section 5.3.1.1).



The on-board barometer is a low accuracy sensor used only for measuring changes in atmospheric pressure over short periods of time (see Section 3.2.4). PPCH measurement uncertainty does not depend on the measurement uncertainty of the on-board barometer unless it is used as a source of $P_{std,0}$ for AutoZ in absolute measurement mode (see Section 3.5.1).

○ OPERATION

To edit the values of PA and PM for the barometer, press **[SPECIAL]**, **<8cal>**, **<2barometer>**. Pressing **[ENT]** steps through displays of the calibration date **<YYYYMMDD>** and PA and PM. In **edit** mode, the values can be edited. Pressing **[ENT]** after the last screen activates the edited values.



To view the current output of the on-board barometer, press **[SPECIAL]**, **<7Internal>**, **<2baro>**.

5.5 ADJUSTMENT OF UTILITY SENSOR

○ PURPOSE

To adjust the output of the utility sensor, if present (see Section 1.2.2.2).

○ PRINCIPLE

PPCHs that do not have a Q-RPT in the Internal, Hi (IH) position, have a utility sensor.

The utility sensor output can be adjusted using PA and PM values in the same manner as for the Q-RPTs (see Section 5.3.1.1).



The utility sensor is not intended to serve as a pressure reference for low uncertainty, traceable measurement. It is for indication, pressure control and system maintenance functions only. PPCH measurement uncertainty when using Q-RPTs does not depend on the measurement uncertainty of the utility sensor.

○ OPERATION

The procedure to adjust the output of the utility sensor is the same as for the calibration of an Internal, Hi (IH), Q-RPT (see Section 5.3.1), but the calibration reference uncertainty can be between 0.01 and 0.05 % FS. To view/edit the calibration information for a utility sensor, use **[SPECIAL]**, **<8cal>**, **<1Hi RPT>**. The position designator of a PPCH utility sensor is always **<luH>**.

5.6 FILLING AND DRAINING THE FLUID RESERVOIR

5.6.1 INTERNAL RESERVOIR



Before attempting to fill or drain the internal reservoir, the internal reservoir accessories must be installed on PPCH (see Section 2.3.6.1).

These instructions apply only when NO external reservoir is being used. See Section 5.6.2 if using an external reservoir.

5.6.1.1 FILLING THE INTERNAL RESERVOIR



PPCH has a level detector in its internal reservoir. When the fluid level is low, the condition is indicated by an audible alarm and intermittent display of <Reservoir level low> on the display bottom line (see Section 3.5.7.3).

To fill the internal reservoir, proceed as follows (see illustration Figure 19):

- ❶ Check that **RESERVOIR FILL/DRAIN** valve is set to **OPEN**. Open if necessary and observe the reservoir fluid level in the acrylic **FILL/DRAIN** tube (do not open the valve if the internal reservoir accessories are not installed).
- ❷ Check that the **RESERVOIR RETURN** valve is set to **INTERNAL**. Set to **INTERNAL** if necessary.
- ❸ Check that the **OVERFLOW** port is NOT plugged. Unplug if necessary.
- ❹ Slowly pour fluid into the **FILL/DRAIN** tube using the supplied funnel. Fill up to, but not over, the **MAX FILL** line. Only fill the PPCH with the same fluid with which it was previously filled. Do not mix or attempt to change fluids.
- ❺ Should the reservoir be overfilled, excess fluid will drain out of the **OVERFLOW** port and should be apparent in the **FILL/DRAIN** tube. In order for the PPCH internal reservoir fluid head reference level to be correct, it is necessary to drain oil until the level is below the **MAX FILL** line (see Section 5.6.1.2).

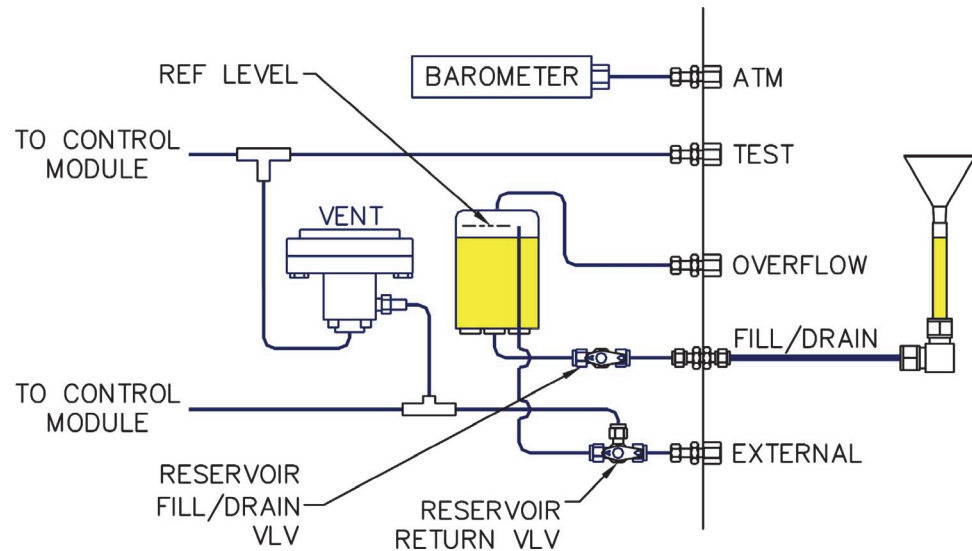

Figure 19. Internal reservoir schematic

5.6.1.2 DRAINING THE INTERNAL RESERVOIR

To drain the internal reservoir, proceed as follows (see illustration Figure 19):

- ❶ Check that **RESERVOIR FILL/DRAIN** valve is set to **OPEN**. Open if necessary (do not open the valve if the internal reservoir accessories are not installed).
- ❷ Check that the **OVERFLOW** port is NOT plugged. Unplug if necessary.
- ❸ Very slightly loosen the 1/4 in. swage nut that connects the **FILL/DRAIN** tube assembly to the **FILL/DRAIN** port.
- ❹ Prepare a receptacle to catch the drained fluid under the **FILL/DRAIN** tube. Reservoir contents when full is about 300 cc.
- ❺ Rotate the **FILL/DRAIN** tube assembly downward to a vertical position in which fluid runs out the tube. The reservoir should drain fully in a few moments.



If you have drained the reservoir because the test fluid has become contaminated or broken down, consider purging the fluid in the PPCH system (see Section 5.6.3).

5.6.2 EXTERNAL RESERVOIR

These instructions apply only when an external reservoir is being used. See Section 2.3.6.2 to install an external reservoir. See Section 5.6.1 if NOT using an external reservoir.

5.6.2.1 FILLING THE EXTERNAL RESERVOIR



PPCH has a level detector in its internal reservoir. When the fluid level is low, the condition is indicated by an audible alarm and intermittent display of <Reservoir level low> on the display bottom line (see Section 3.5.7.3). If the external reservoir has been installed as recommended in Section 2.3.6.2, the reservoir level warning system is still active.

To fill the external reservoir, proceed as follows (see illustration Figure 20):

- ❶ Check that **RESERVOIR FILL/DRAIN** valve is set to **OPEN**. Open if necessary (do not open the valve if the external reservoir is not connected to the **FILL/DRAIN** port).
- ❷ Fill the external reservoir with fluid. Use only the fluid that is already present in the PPCH. Fill only with the same fluid which is already present in the PPCH. Do not mix or attempt to change fluids.
- ❸ If the **OVERFLOW** circuit has not been purged of air, purge it. Loosen the **OVERFLOW** plug and allow fluid to run until the runoff is air free. Tighten the plug when complete.
- ❹ Leave **RESERVOIR FILL/DRAIN** valve set to **OPEN**. PPCH will not operate correctly with valve set to **CLOSE** position.

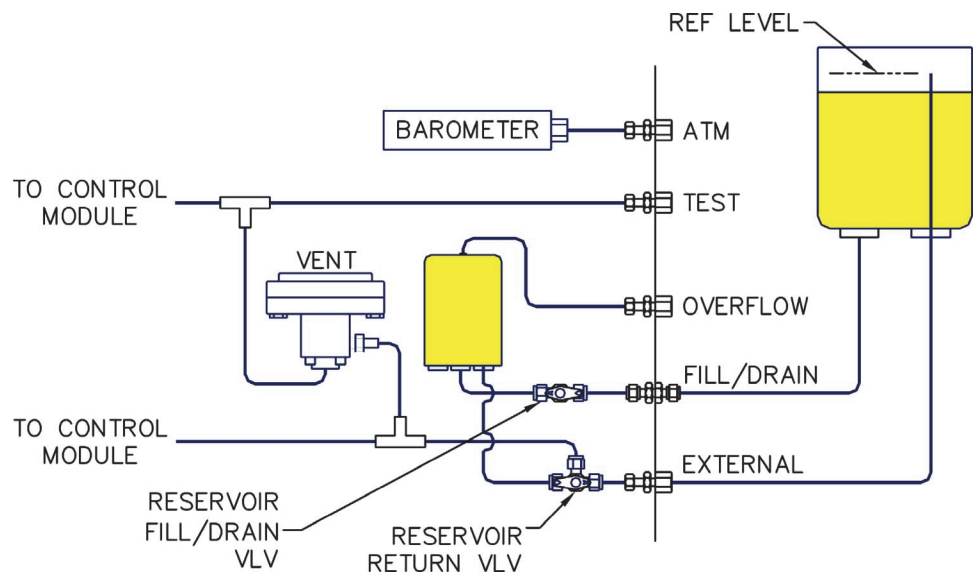

Figure 20. External reservoir schematic

5.6.2.2 DRAINING THE EXTERNAL RESERVOIR

To drain the external reservoir, proceed as follows (see illustration Figure 20):

- ❶ Empty the external tank.
- ❷ Check that the **RESERVOIR RETURN** valve is set to **EXTERNAL**. Set to **EXTERNAL** if necessary.
- ❸ Prepare a receptacle at a level lower than the PPCH to collect fluid that will be drained from the external tank connecting tubes and the internal reservoir.
- ❹ Disconnect the external tank fill tube from the external tank and place it in the receptacle.
- ❺ Remove the **OVERFLOW** port plug.
- ❻ Fluid will run out the external tank fill tube. Wait a few moments for the flow to stop.
- ❼ Disconnect the external tank return tube from the external tank and place it in the receptacle.
- ❽ When the tubes have drained, detach them from the PPCH.



If you have drained the reservoir because the test fluid has become contaminated or broken down, consider purging the fluid in the PPCH system (see Section 5.6.3).

5.6.3 PURGING CONTAMINATED FLUID FROM THE PPCH

○ PRINCIPLE

The test fluid in the PPCH may become contaminated due to flowback from the test system or breakdown with repeated exposure to high temperature. In this case, the fluid should be drained, the PPCH should be purged and the reservoir should be refilled with fresh fluid.

○ PROCEDURE

To purge contaminated fluid from the PPCH, proceed as follows:

- ❶ Vent the PPCH.
- ❷ Drain the reservoir of contaminated fluid (see Section 5.6).
- ❸ Refill the reservoir with fresh fluid (see Section 5.6).
- ❹ Open the **TEST** port. Hold a collection cup under the **TEST** port to catch fluid that will be expelled.
- ❺ Use [**PRIME**], <1**prime**> (see Section 3.3.8.1) to cause the hydropneumatic pump to start pumping.
- ❻ Observe the fluid coming out of the **TEST** port until it flows clean.
- ❼ Press [**ESC**] to abort the priming routine and stop the pump.

5.7 VOLUME CONFIGURATION

○ PURPOSE

To run an automated routine that determines the volume of the system into which the PPCH is controlling pressure to optimize the performance of PPCH pressure control.

○ PRINCIPLE

PPCH pressure control is volume dependent. For optimal pressure control, PPCH must have a valid estimation of the size of the volume connected to the PPCH **TEST** port. PPCH determines the volume to which it is connected and adapts without operator intervention in normal operation. In dynamic control mode operation, if PPCH's estimation of the volume seems incorrect as evidenced by unexpected control response, the PPCH runs a 0.5 to 2.5 minute routine to determine the test volume. The volume determination routine can also be initiated by the operator using [**SPECIAL**], <7**Internal**>, <1**config**>, <1**volume**>, <1**run**>.

The operator initiated volume determination routine can be useful after a test volume change to avoid the increased control time and reduced control precision that may exist until PPCH automatically determines the volume. This might be performed, for example, before starting a new test. The volume determination routine can also be initiated remotely (see Section 4.4.1).



Thermal pressure control (TPC) is only used in dynamic control mode. Therefore, the volume configuration routine can only execute when standard dynamic control mode is active.



Due to the relatively high compressibility of low pressure oil, the configuration routine does not produce reliable results when run at a starting pressure under 1 MPa (150 psi). Therefore, the volume configuration routine cannot be run under 1 MPa (150 psi). It is recommended that volume configuration be run at a pressure greater than 7 MPa, if possible.



The test volume that PPCH has determined can be viewed using [SPECIAL], <1config>, <1volume>, <2view>.

○ OPERATION



Poor control is usually caused by invalid control parameters, excessive leaks and restrictions in the test system or other set up problems. These problems should be identified and eliminated before resorting to use of the configuration function (see Section 6).



PPCH uses self diagnostics to determine when to run the volume configuration routine in dynamic control mode. Therefore, it is not normally necessary to run the configuration routine separately.



Running the volume configuration routine may cause the set pressure to increase or decrease by up to 1.4 MPa (200 psi) from the starting point.

The volume configuration routine may be run at any pressure greater than 1 MPa (150 psi). Dynamic pressure control mode must be active. The test system must be leak free (see Section 3.3.9 to leak check).

Wait at least five minutes after switching to dynamic control mode before running the volume configuration.

Set a pressure greater than 1 MPa (150 psi) and preferably greater than 7 MPa (1 000 psi).

Wait five minutes after the set pressure is *Ready* (see Section 3.2.3).

To access the volume configuration function press [SPECIAL], <7internal>, <1config>, <1volume>, <1run>. The display is:

Selecting <1yes> causes the volume determination routine to run. While the routine is running, <Running vol config...> flashes on the bottom line of the PPCH display.

```
Run volume config?
1yes 2no
```

Completing the routine may take up to 2.5 minutes and cause the pressure to change by up to 1.4 MPa (200 psi).

When the volume determination is complete the display is:

```
Vol estimate: 20 cc
Activate? 1yes 2no
```

Select <1yes> to activate the new volume determination. Select <2no> to retain the old volume determination and return to the main run screen.

To view the estimate of test volume currently being used by PPCH, press [SPECIAL], <7internal>, <1config>, <1volume>, <2view>.

5.8 VALVE OPENING POINT CONFIGURATION

○ PURPOSE

To run an automated routine that updates the opening point tables of PPCH's servo-controlled valves.



Poor pressure control is usually caused by invalid control parameters, excessive leaks and restrictions in the test system or other set up problems. These problems should be identified and eliminated before resorting to use of the configuration function (see Section 6).

○ PRINCIPLE

PPCH uses servo-controlled needle valves to precisely admit and exhaust fluid into and out of the test volume. Knowledge of the opening points of these valves is critical to pressure control performance. Systematically working into a large test volume (i.e. > 100 cc) and/or changes in the valves over time, may make it desirable to update the valve opening point tables. The PPCH on-board valve opening point configuration routine tests and updates the opening points.

The VALVE CONFIG function should be considered a maintenance function and used to attempt to improve pressure control only when all other factors affecting pressure control have been examined and eliminated (for example leaks, restrictions in test lines, air in test volume, low drive pressure supply).

In addition, the VALVE CONFIG function allows valve opening point tables to be returned to original factory values. This feature can be useful to return to known conditions after the on-board configuration function has been run.

○ OPERATION



Poor pressure control is usually caused by invalid control parameters, excessive leaks and restrictions in the test system or other set up problems. These problems should be identified and eliminated before resorting to use of the configuration function (see Section 6).



The VALVE CONFIG routine will cause PPCH to set pressure of 95% of the controller's maximum pressure. Be sure that there are not devices connected to the PPCH TEST port.

To prepare to run the VALVE CONFIG routine:

- ➊ Set the PPCH range to the default range of the internal, high Q-RPT or utility sensor (see Section 3.3.1).
- ➋ Plug the PPCH **TEST** port. Do not connect any external volume.
- ➌ Assure the PPCH is leak free (see Section 3.3.9 for leak check).
- ➍ Vent the PPCH and wait at least 3 minutes.

To access the VALVE CONFIG function press [**SPECIAL**], <7**internal**>, <1**config**>, <2**valves**>. Select <2**factory**> to cause PPCH to load original factory valve opening point tables. This feature can be useful to return to standard conditions if a faulty VALVE CONFIG routine has been activated or the current configuration is no longer valid.

Select **<1run>** to cause the VALVE CONFIG routine to execute. This display is:

This display warns the user that pressure will increase to roughly 95 % of the PPCH maximum range. Press **[ENT]** to continue.

**CAUTION: Will set up
to 95 MPa g**

<Running valve config> flashes in the lower right corner of the display. PPCH sets pressures and measures valve opening points. After about 30 minutes, the user is asked whether or not to save the new configuration. If the VALVE CONFIG function ran completely and without incident, select **<1yes>**. Select **<2no>** to return to the MAIN RUN screen with no change to the valve opening point tables.



The effect of the CONFIG function can be eliminated and control coefficients returned to factory defaults by pressing **[SPECIAL]**, **<7Internal>**, **<1Config>**, **<2valves>**, **<2factory>**.

5.9 ACCESSING PPCH MECHANICAL MODULE

○ PRINCIPLE

To access the PPCH mechanical module, the chassis is opened from the rear and the module slides out on rails.

○ PROCEDURE

To access the PPCH mechanical module, proceed as follows:

- ❶ Vent the PPCH and disconnect electrical power and drive air supply.
- ❷ Position the PPCH on its bottom leaving at 90 cm (36 in.) of clear space behind it.
- ❸ Use a Phillips head screwdriver to unscrew the 18 fasteners around the perimeter of the main rear panel.
- ❹ Using the handles on the back of the PPCH, slowly pull out the hydro-pneumatic chassis. It slides out on rails.
- ❺ Continue to pull the chassis out slowly until a locking stop can be felt. The mechanical module can now be accessed for service.

To slide the mechanical module back into the PPCH chassis, proceed as follows:

- ❶ Push the chassis back into the PPCH until you feel a locking stop.
- ❷ Locate the locks on the side rails. Lift up on the left latch and press down on the right latch, as viewed from the rear of the PPCH.
- ❸ Further slide the chassis into the PPCH enclosure, taking care not to snag any of the wires within the PPCH.
- ❹ Tighten all 18 fasteners on the PPCH main rear panel.

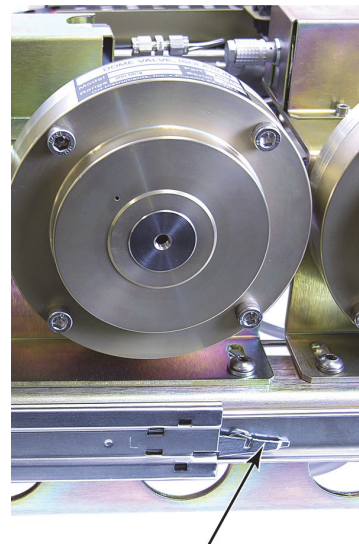

**SIDE RAIL LATCH
(LEFT FROM REAR VIEW)**

Step 2

5.10 HYDROPNEUMATIC PUMP

5.10.1 PRIMING THE PUMP

○ PURPOSE

To run an automated routine that reprimed the PPCH's on-board, hydropneumatic pump when it has pumped air instead of liquid.

○ PRINCIPLE



A pump that has lost its prime cycles rapidly and continuously while attempting to generate pressure. To stop the pump immediately, cycle PPCH power. This interrupts the drive air supply to the pump until a new pressure generation attempt. The pump can also be stopped by venting the PPCH using [VENT].

The PPCH on-board hydropneumatic pump is an air driven hydraulic pump. The hydraulic side of the pump must be continuously supplied with liquid. If significant amounts of gas are drawn into the pump, the pump will lose its prime. A pump that has lost its prime pumps rapidly (more than once per second) without generating significant pressure.

Once the pump has lost its prime, oil must displace the gas in the pump before the pump will operate normally again. This requires forcing oil into the pump.

The PPCH pump priming routine uses the drive air supply to pressurize the reservoir, forcing oil into the pump. This makes recovery from accidentally introducing gas into the pump, for example if the pump was run with the reservoir empty, relatively convenient.

If the on-board prime routine is unable to prime the pump, the check valve prime procedure may be necessary (see Section 5.10.1.1).

○ PROCEDURE



The pump priming routine will generate pressure of mid-scale or more of the active pressure range. Before running the priming routine, plug the TEST port

To reprime the on-board hydropneumatic pump, proceed as follows:

- ❶ Fill the reservoir (see Section 5.6) to at least the point at which the MAIN RUN screen <Low fluid level> goes off (see Section 3.5.7.3).
- ❷ Close the **RESERVOIR FILL/DRAIN** valve. Failure to close this valve will cause liquid to be forcibly ejected from the **FILL/DRAIN** port when attempting to prime!
- ❸ Set the range to default, internal high (DF IH) (see Section 3.3.1).
- ❹ Assure that the **TEST** port is NOT open. Plug the **TEST** port. Liquid will be driven out the **TEST** port during priming if it is open.
- ❺ Press [**SPECIAL**], <7internal>, <3pump>, <1prime>.

- ⑥ Press **[ENT]** to start priming. The display is:

1. Standard main run screen first line.
2. Indication of pump priming attempt cycle.

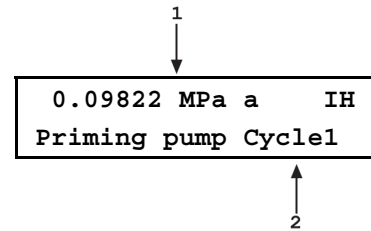

- ⑦ PPCH operates internal valves to apply pneumatic drive pressure to the reservoir, forcing fluid into the pump, and operates the pump, attempting to fill the pump with oil and generate pressure for about 15 seconds. If unable to generate pressure within the time limit, the process is repeated. Each repeat is a cycle.

Press **[ESC]** or **[ENT]** to abort the pump priming process and return to the main run screen.

If the pump is not primed successfully after five cycles, abort the priming process. The check valve prime procedure may be necessary (see Section 5.10.1.1).

- ⑧ When the pump priming process is successful, pressure of about mid-scale of the active range is generated and the display second line flashes **<Priming complete>**. Press **[ESC]** or **[ENT]** to vent and return operation to the main run screen.

5.10.1.1 PRIMING THE PUMP CHECK VALVE

○ PRINCIPLE

If the pump fails to prime using the standard procedure (see Section 5.10.1), it is necessary to crack the pump outlet fitting while priming to allow unrestricted flow out of the pump.

○ PROCEDURE

To prime the pump check valve, proceed as follows:

- ① Vent the PPCH.
- ② Disconnect the **TEST** port and leave it open.
- ③ Turn OFF the drive air supply.
- ④ Use **[PRIME]**, **<2cycle>** to cause PPCH to attempt to generate a pressure and open the inlet control valve. Watch the **TEST** port as small amounts of fluid may be expelled.
- ⑤ Observe the pressure displayed by the PPCH. When the pressure returns to the vented pressure (0 gauge or atmospheric in absolute mode) press **[ESCAPE]** to abort the cycle.
- ⑥ Turn OFF PPCH power.
- ⑦ Open PPCH chassis to gain access to the mechanical module which includes the hydropneumatic pump (see Section 5.9).
- ⑧ Place a paper towel around the DH500 outlet check valve fitting.
- ⑨ Using a 5/8 in. wrench, loosen the DH500 outlet check valve fitting about 1/2 turn. A small amount of oil may be expelled.

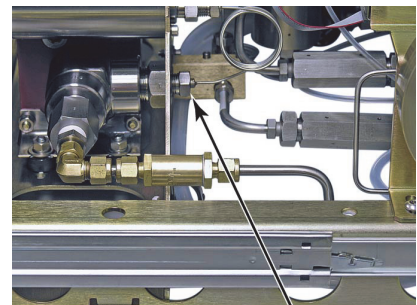

PUMP OUTLET FITTING

Step 8 and 9

- ⑩ Turn ON PPCH power and turn ON the drive air supply.
- ⑪ Plug the **TEST** port with a DH500 gland and plug.
- ⑫ Use [**SPECIAL**], <7**internal**>, <3**pump**>, <1**prime**> (see Section 5.10.1) to cause the pump to start to cycle. Be sure to close the reservoir **DRAIN/FILL** valve as requested.
- ⑬ As soon as the pump starts to cycle rapidly, tighten the DH500 outlet check valve fitting. Once the fitting is tightened, the cycle rate of the pump should decrease and the PPCH pressure should increase.
- ⑭ Allow the pump priming routine to complete (see Section 5.10.1).
- ⑮ Slide the mechanical module back into the PPCH chassis (see Section 5.9).

5.10.2 PUMP REPLACEMENT

○ PRINCIPLE

The PPCH's hydropneumatic pump has wear-subjected parts. Other than the spool valve (see Section 5.10.3), the pump is not normally serviceable by the user. A failed or failing pump may be indicated by failure to generate pressure, inability to reach maximum pressure, oil mist coming from pump air exhaust (see Troubleshooting Section 6).

To avoid pump failure in operation, it is recommended that the pump be changed after 2000 hours of pressurized operation. Pump pressurized operating time is recorded by a timer and can be displayed (see Section 3.5.7.3.4).

Refurbished as well as new PPCH pumps are available from DH Instruments and DHI Authorized Service Providers.

See Section 5.1, Table 25 for new and refurbished pump information.

○ PROCEDURE

To replace the PPCH hydropneumatic pump, proceed as follows:

- ① Vent the PPCH and disconnect electrical power and drive air supply.
- ② Disconnect **TEST** connections and plug the test port with a DH500 plug.
- ③ Close the reservoir **FILL/DRAIN** valve on the PPCH rear panel. Empty the **FILL/DRAIN** tube.
- ④ Place the PPCH on a bench on its left side. Do not place the unit on its right side or fluid leakage may occur. Rotate the inlet supply tube and funnel to the upright position.

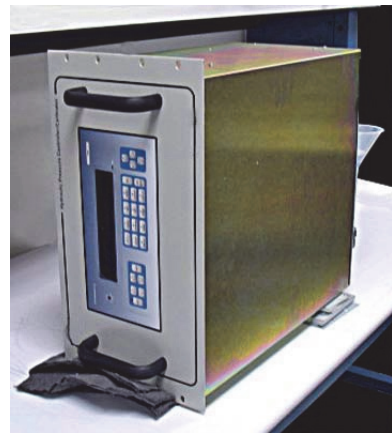

Step 4

- 5 Open PPCH chassis to gain access to the mechanical module which includes the hydropneumatic pump (see Section 5.9).

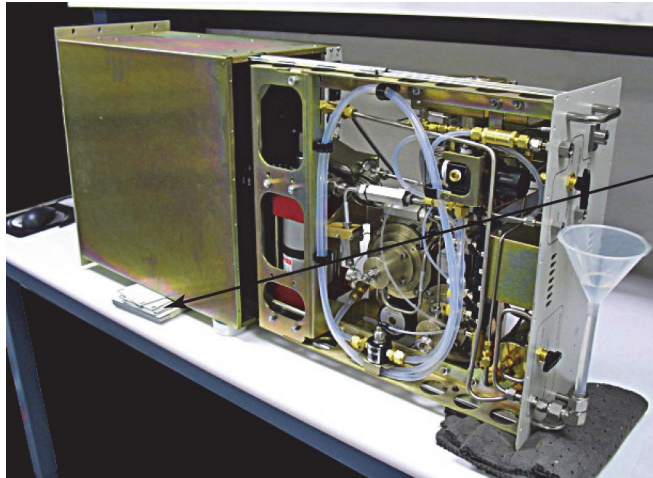

MAKE SURE MIDDLE IS SUPPORTED TO PREVENT DAMAGE TO DRAWER RAILS.

- 6 Disconnect the inlet, outlet, and drive connections from the pump.



Wrap the fittings with paper towels and wear safety glasses when cracking the pump outlet port. Full pump pressure stored in the accumulator volume will expel about 1 cc of fluid through the pump outlet weep hole.

- 7 Remove the nuts that hold the pump shock mounts and push the mounts out of the holes
- 8 Remove the top left mount from the pump. This will allow the pump to pivot into the enclosure and then out of the top of the unit.
- 9 Install the new pump in the reverse order (see Section 5.1, Table 25 to identify the correct pump to installed). Apply Loctite™ 242 or equivalent non-permanent thread locker to the pump mount threads and torque the nuts to 6 Nm. To not over tighten the nuts or the rubber will strip out.
- 10 Slide the mechanical module halfway into the enclosure until it stops (see next photo).
- 11 Carefully position the unit to the upright position. Reorient the **FILL/DRAIN** tube.
- 12 Slide the drawer fully out again, connect electrical power and drive air. Plug the test port.
- 13 Prime the pump (see Section 5.10.1).
- 14 Set a pressure to 50% of full scale and visually check for leaks. When finished, vent the system.
- 15 Slide the mechanical module back into the PPCH chassis (see Section 5.9).
- 16 Open reservoir **FILL/DRAIN** valve.
- 17 Purge system for 20 cycles to 75% of controller full scale, using **[PRIME]**, **<2purge>** (see Section 3.3.8.2).



Step 6

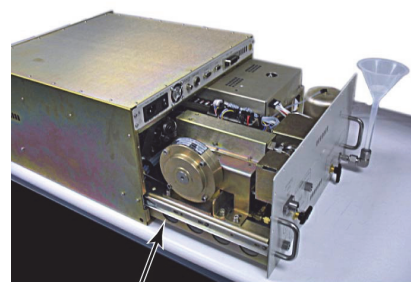

Step 11

5.10.3 PUMP SPOOL VALVE INSPECTION OR REPAIR

○ PRINCIPLE

The hydro pneumatic pump's pneumatic spool valve assures the proper direction of drive air to move the pump's pistons. The valve can fail to cycle properly because of damage to the valve seals due to wear or operation with excessively dry drive air.

Failure or deterioration of the spool valve is characterized by inability of the pump to reach maximum pressure (need to increase drive air pressure) or by continuous flow of drive air through the pump without any cycling action.

○ PROCEDURE

To inspect and/or repair the pump spool valve, proceed as follows:

- ❶ Vent the PPCH and disconnect electrical power and drive air supply.
- ❷ Open PPCH chassis to gain access to the mechanical module which includes the hydro pneumatic pump (see Section 5.9). Locate the spool valve assembly.
- ❸ Remove the three 3 mm socket head cap bolts that hold the spool valve body to the pump.
- ❹ Gently maneuver the spool valve assembly to access and remove the 11/16 in. drive air nut that is attached to the drive tube.
- ❺ Observe O-ring placement on the bottom of the spool valve body.
- ❻ Remove the 1/4 in. NPTM x 3/8 in. swage fitting. Note orientation of this fitting.
- ❼ Locate end cap and retaining clip on the end of the spool valve body. Remove retaining clip using the appropriate snap ring tool.

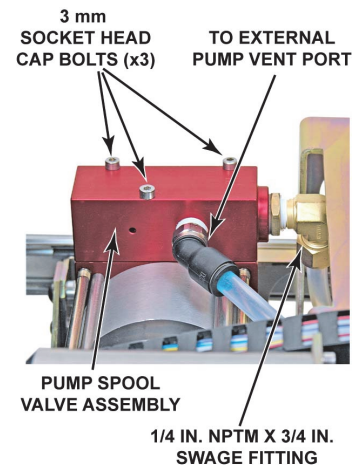

Step 2 and 6

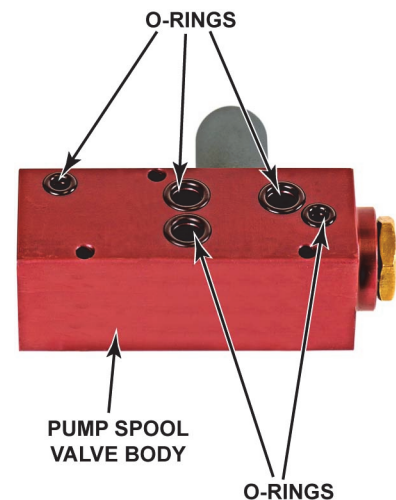

Step 5

- ⑧ Use a soft (wood/plastic) dowel to press out the spool valve and end cap. **Do not remove the inner sleeve assembly.** Note that it is very rare for this inner sleeve assembly to have problems.

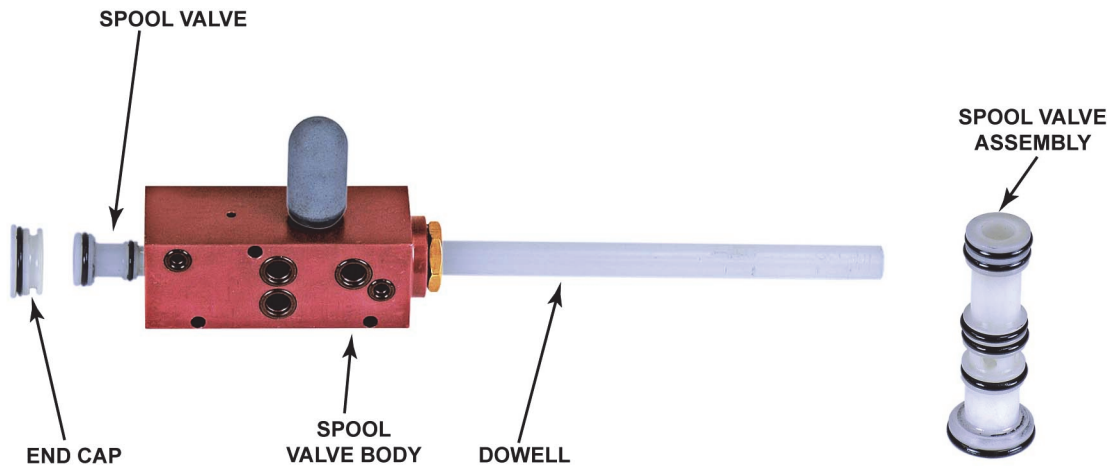

Step 8

Step 10

- ⑨ Inspect and clean inner cylinder bore with a clean cloth.

- ⑩ Clean and inspect spool valve assembly and O-rings.

- ⑪ Replace any cut or worn O-rings with the appropriate O-rings from kit p/n 101891.

- ⑫ Lightly lubricate the exterior of all o-rings on the spool valve using Kluber POLYLUB GA 352 or equivalent (light, mineral oil based, high quality grease).

- ⑬ Place spool valve into valve body.

- ⑭ Clean and inspect end cap. Lubricate exterior area of o-ring.

- ⑮ Place plug back into spool valve body.

- ⑯ Seat the retaining clip back into the spool valve body. Note that a good deal of force is required to properly seat the retaining clip. Make certain that the retaining clip is fully in place.

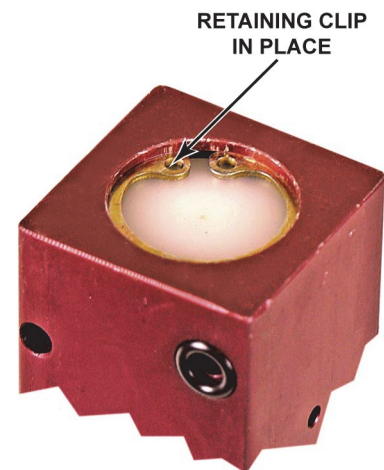

Step 16

- ⑰ Remove and reapply new Teflon tape on the drive air fitting.

- ⑱ Reinsert the drive air fitting back into the spool valve body. Note previous orientation of this fitting.

- ⑲ Maneuver spool valve body to reattach the drive air connection.

- ⑳ Mount spool valve body to the pump and tighten the three M3 socket head cap bolts. Assure that the O-rings are properly placed on the bottom of the spool valve body (see Step 5.).

- ㉑ Ensure that the 11/16 in. drive air fitting is fully tightened.

- ㉒ Slide the mechanical module back into the PPCH chassis (see Section 5.9).

- ㉓ Reconnect electrical power and drive air. Power up the PPCH.

- ㉔ Test for proper pump operation by setting pressure points (see Section 3.3.10).

5.10.4 PUMP INLET FILTER (LIQUID) REPLACEMENT

○ PRINCIPLE

The pump inlet filter is intended to protect the pump and the PPCH from contamination in the oil drawn from the PPCH reservoir by the pump. The filter is between the PPCH internal reservoir and the pump. The filter may become clogged with contaminants over time preventing adequate oil flow and causing the pump to be starved for hydraulic fluid. The symptom of a starved pump is rapid cycling without generating pressure. The pump filter should be replaced or cleaned by flushing as part of PPCH preventive maintenance or when symptoms of clogging are observed.

○ PROCEDURE

To replace the inlet filter (liquid), proceed as follows:

- ❶ Vent the PPCH and disconnect electrical power and drive air supply.
- ❷ Close the reservoir **FILL/DRAIN** valve on the PPCH rear panel.
- ❸ Open PPCH chassis to gain access to the mechanical module (see Section 5.9 for instructions).
- ❹ If the PPCH is a single Q-RPT or utility sensor (no Lo Q-RPT), the filter can be accessed through the top of the PPCH chassis.

If the PPCH has a Lo Q-RPT, the PPCH must be placed on its side so that the bottom of the mechanical module is facing you.

Looking at the PPCH from the rear, place the PPCH on its **RIGHT** side to avoid draining fluid from the reservoir. When turning the PPCH on its side, do so carefully supporting the chassis and main body and the mechanical drawer to avoid damaging the slide rails.

- ❺ Using 9/16 in. and 1 in. wrenches, loosen both sides of the pump filter. **NOTE DIRECTION OF EXISTING FILTER!**
- ❻ Remove filter.
- ❼ Install new filter



Units built prior to December 2008 will require filter kit p/n 3401429 which includes replacement filter and a pre-attached extension tube to compensate for difference in filter length. Units built later will require only the filter p/n 3138000 (102808) (see Step 5).

- ❽ Tighten fittings.
- ❾ If the PPCH has a Lo Q-RPT, set the system back to a normal position. Reconnect electrical power and drive air. Power up the PPCH.
- ❿ Perform pump prime procedure (see Section 5.10.1). Check filter connections for leaks.
- ⓫ Open reservoir **FILL/DRAIN** valve.
- ⓬ Close PPCH chassis (see Section 5.9).

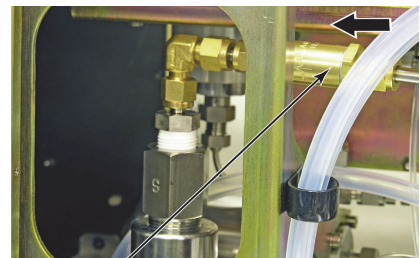

PUMP INLET FILTER (LIQUID)

**Previous Pump Supply Filter P/N
3068879 (103727)**

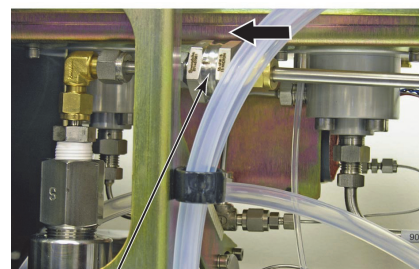

PUMP INLET FILTER (LIQUID)

**New Pump Supply Filter P/N
3138000 (102808)**

Step 5

5.11 LEAK CHECKING

Leaks within the PPCH pressure controller/calibrator or in the test system connected to it can prevent PPCH from being able to properly set and control pressure. If PPCH operational symptoms indicate the possibility of a leak, the test system connected to the PPCH should first be leak checked. If no leak is identified, the PPCH itself should be leak checked separately independently from the test system.

Large leaks in a visible component can usually be identified by an accumulation of test fluid. When looking for a leak, first examine the test system vessels and interconnect points for any accumulation of fluid. If fluid is observed, wipe it away and check if it returns while the PPCH is pressurized. Any leak large enough to cause visible accumulation of fluid in a short time is likely to cause the PPCH to be unable to operate reliably.

Other than the accumulation of fluid method, the only way to determine if a significant leak is present is by a pressure decay method. This can be performed using the PPCH to set a pressure and then using the internal Q-RPT or utility sensor to measure decay. However, to arrive at conclusive results, the leak test must be performed very carefully. The pressure must be truly stabilized before starting the measurement and the measurement must be made over a substantial period of time.

Section 5.11.1 describes the pressure decay leak testing method. Section 5.11.2 describes procedures to localize a leak within the PPCH.

5.11.1 PRESSURE DECAY LEAK TESTING METHOD

○ PROCEDURE

To determine whether a leak is present in a system by measuring the rate of pressure decay, a pressure is set, allowed to stabilize and then the pressure change over time is observed.

○ PRINCIPLE

To measure a leak by the rate of pressure decay method, proceed as follows:

- 1 To leak test a system external to the PPCH, connect the system to the PPCH **TEST** port and purge and prime it (see Section 2.4.4). If there is a PG7302 piston gauge in the system, it must be isolated from the system as the leak through it's piston-cylinder can be confused with a leak in the system.

To leak test the PPCH itself, plug the **TEST** port using a DH500 plug (provided in PPCH interconnections kit). It is not possible to establish conclusively that the PPCH is leaking unless no system is connected to the **TEST** port and the port is plugged

- 2 Use **[SETUP]**, **<6control>**, **<2mode>**, **<2static>** to set the PPCH to operate in static control mode (see Section 3.4.6.2). This mode is used because it turns off the thermal pressure control unit (TPCU) whose action might interfere with the pressure decay measurement (see Section 3.2.1).

If the PPCH has a Lo Q-RPT, use **[RANGE]** to select the Lo Q-RPT as the active Q-RPT.

- 3 Use **[ENTER/SET P]** (see Section 3.3.10.2) or the direct pressure control keys (see Section 3.1.3) to set a pressure of at least 90% of the active Q-RPT or utility sensor maximum pressure or of the maximum pressure of the test system connected to the PPCH.
- 4 Once the desired pressure has been set, press **[ESC]** to abort pressure control. This stop assures PPCH will not attempt to control pressure and interfere with the pressure decay measurement.
- 5 Wait for the effects of the just completed pressure change to dissipate. This requires at least 5 minutes and may be longer if there is a large test volume connected.

- ⑥ Use **[LEAK CK]** to run a leak test (see Section 3.3.9). Set the leak check time to at least 120 seconds and allow the leak check to complete. Repeat the process once or twice to verify repeatability of the measurement.
- ⑦ Evaluate the leak rate. Calculate the leak rate relative to the measured pressure. For example, if the rate is 0.007 MPa/second and the measured pressure 70 MPa, the rate of change of pressure is 0.01% of the measured pressure per second ($0.007 / 70 * 100$).
 - A negative or positive rate of less than 0.001% of measured pressure per second: there is no significant leak present.
 - A negative rate of 0.001% to 0.005% of measured pressure per second: there is probably a leak in the system but it should not significantly affect PPCH pressure control. It may, however, cause an excessive piston drop rate if the PPCH is being used with a PG7302 piston gauge.
 - A negative rate greater than 0.005% of measured pressure per second: there is a leak that is likely to cause the PPCH to be unable to operate reliably (and will be messy in terms of lost fluid). The leak should be corrected. If the leak is internal to the PPCH (leak check was performed with PPCH plugged), see Section 5.11.2 to localize the leak.
 - A positive rate consistently greater than 0.001% or reading per second: there is a leak in the PPCH inlet control valve that may interfere with pressure control (see Section 5.12.2).

5.11.2 LOCALIZING A LEAK WITHIN THE PPCH

To determine if there is a leak in the PPCH, first leak check the complete PPCH by running a pressure decay leak test with the PPCH **TEST** port plugged (see Section 5.11.1).

If there is a positive leak in the PPCH (leak test rate result is always positive), there is a leak in the PPCH inlet control valve and the control valve needs service (see Section 5.12.2).

If there is a negative leak in the PPCH, the leak could be in a shutoff valve, in the outlet control valve or in another component.

First check for a leak in a shutoff valve. PPCH has up to three shutoff valves (see Section 3.2.1, Figure 9). All PPCHs have a high pressure vent valve (see Section 5.11.2.1 to localize a leak to the high pressure vent valve). PPCHs that are equipped with a Lo Q-RPT also have a low pressure isolation valve and a low pressure vent valve. Check the low pressure isolation valve for a leak (see Section 5.11.2.2), then check the low pressure vent valve (see Section 5.11.2.3). Shutoff valves are user replaceable (see Section 5.12.1).

If the leak is not in a shutoff valve, check the PPCH internal components. Access the PPCH mechanical module (see Section 5.9) and examine it for collected fluid at fittings and internal collection point. Wipe away the fluid, be sure pressure is vented and then tighten the fitting (**never tighten a fitting without first removing pressure**). Leak test again to determine whether the leak has been corrected (see Section 5.11.1).

If the leak internal to the PPCH is not in a shutoff valve or a visible internal connection that can be tightened, it is probably in the outlet control valve (see Section 5.12.2) or another area that is not user serviceable.

5.11.2.1 HIGH PRESSURE VENT VALVE LEAK

To identify the high pressure vent valve in the PPCH schematic, see Section 3.2.1, Figure 9.

To localize a leak to the high pressure vent valve, proceed as follows:

- ❶ If the PPCH **TEST** port is not already plugged, plug it with a DH500 gland and plug.
- ❷ If the PPCH has a Lo Q-RPT, use **[RANGE]** to make the Hi Q-RPT or utility sensor active (see Section 3.3.1).
- ❸ Vent the PPCH and disconnect electrical power and drive air supply.
- ❹ Open the PPCH chassis to gain access to the mechanical module (see Section 5.9).
- ❺ Loosen the high pressure vent valve bracket retaining hardware (two button head bolts).

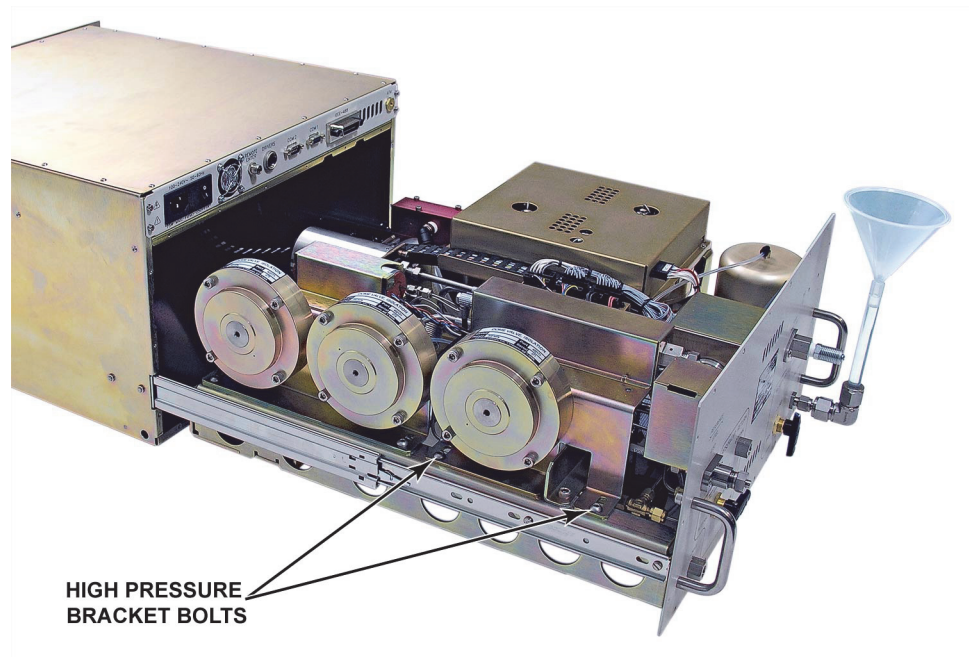

Step 5

- Using a 1/2 in. wrench, loosen the two DH200 high pressure connections on the pressure tube between the vent valve and the thermal pressure control unit (TPCU)

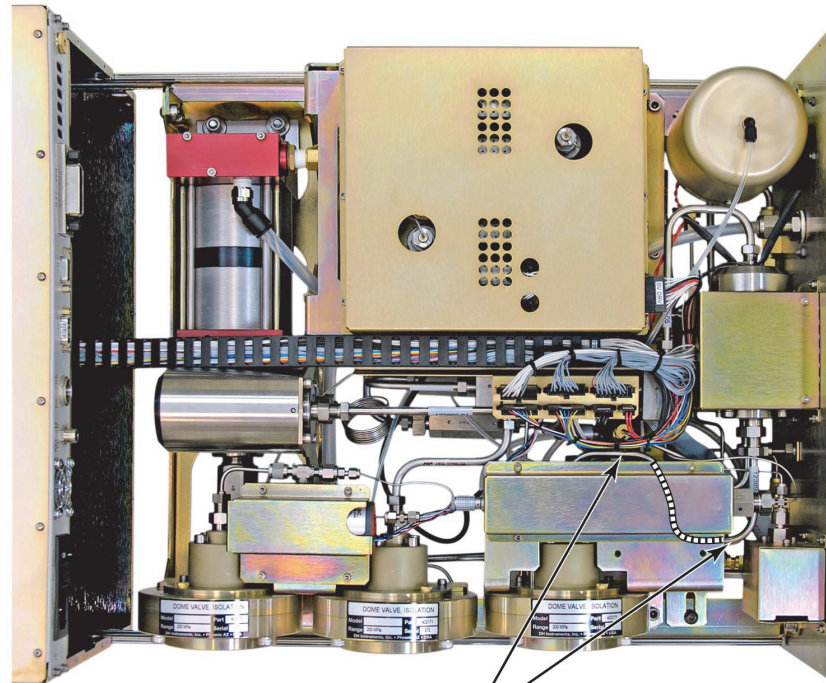

HIGH PRESSURE
VENT VALVE TO
TPCU TUBE

Step 6

- Slide back the valve assembly in the mounting slots to fully remove the loosened tube.
- Install a DH200 gland and plug (supplied with PPCH accessories) in the open port of the TPCU.
- Reapply drive air supply, connect electrical power and power on the PPCH.
- Perform a pressure decay based leak check (see Section 5.11.1).
- If the leak is no longer present then the high pressure vent valve is the cause of the leak and the valve should be replaced (see Section 5.12.1).

If the leak is still present, there is a leak that is not in the vent valve. Reconnect the original vent valve and proceed with additional leak testing to localize a leak within PPCH (see Section 5.11.2).

5.11.2.2 LOW PRESSURE ISOLATION VALVE LEAK

To identify the low pressure isolation valve in the PPCH schematic, see Section 3.2.1, Figure 9.

PPCH includes a low pressure isolation valve only if it has an internal Lo Q-RPT.

To localize a leak to the low pressure isolation valve, proceed as follows:

- ❶ If the PPCH **TEST** port is not already plugged, plug it with a DH500 gland and plug.
- ❷ Use **[RANGE]** to make the Hi Q-RPT or utility sensor active (see Section 3.3.1).
- ❸ Vent the PPCH and disconnect electrical power and drive air supply.
- ❹ Open the PPCH chassis to gain access to the mechanical module (see Section 5.9).
- ❺ Loosen the low pressure isolation valve bracket retaining hardware (two button head bolts).
- ❻ Using a 1/2 in. wrench, loosen the two DH200 high pressure connections on the pressure tube between the isolation valve and the high pressure cross.
- ❼ Slide back the valve assembly in the mounting slots to fully remove the loosened tube.
- ❽ Install a DH200 gland and plug (supplied with PPCH accessories) in the open port of the high pressure cross where the tube was removed.
- ❾ Reapply drive air supply, connect electrical power and power on the PPCH.
- ❿ Perform a pressure decay based leak check (see Section 5.11.1).
- ⓫ If the leak is no longer present then the low pressure isolation valve is the cause of the leak and the valve should be replaced (see Section 5.12.1).

If the leak is still present, there is a leak that is not in the low pressure isolation valve. Reconnect the original isolation valve and proceed with additional leak testing to localize a leak within PPCH (see Section 5.11.2).

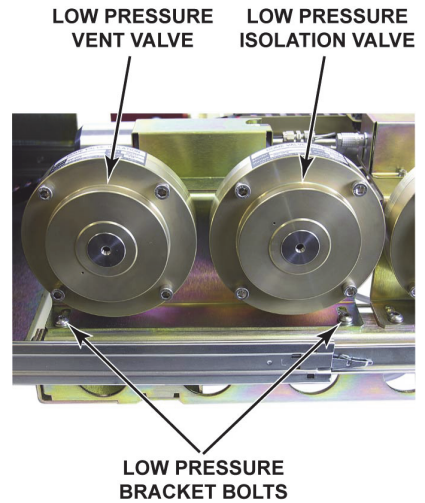

Step 5

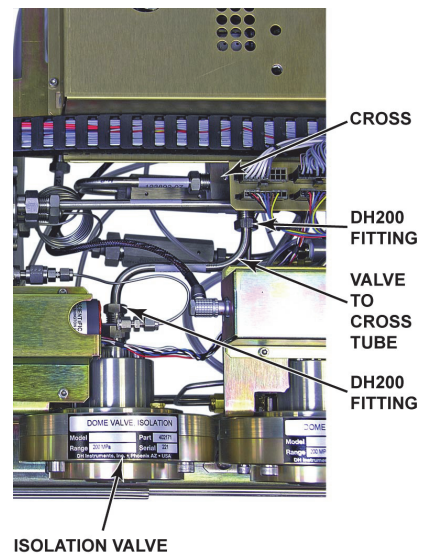

Step 6

5.11.2.3 LOW PRESSURE VENT VALVE LEAK

To identify the low pressure vent valve in the PPCH schematic, see Section 3.2.1, Figure 9.

PPCH includes a low pressure vent valve only if it has an internal Lo Q-RPT.

Before going to the trouble of disconnecting the low pressure vent valve to leak check it specifically, the PPCH low pressure circuit can easily be leak checked if the low pressure isolation valve is known not to leak. To leak check the low pressure circuit, just compare the results of a pressure decay based leak test (see Section 5.11.1) with the Hi Q-RPT active and the Lo Q-RPT active. If the leak is greater with the low Q-RPT active, there is a leak in the Lo Q-RPT circuit and the low pressure vent valve is the most likely source.

To localize a leak to the low pressure vent valve, proceed as follows:

- ❶ If the PPCH **TEST** port is not already plugged, plug it with a DH500 gland and plug.
- ❷ Vent the PPCH and disconnect electrical power and drive air supply.
- ❸ Open the PPCH chassis to gain access to the mechanical module (see Section 5.9).
- ❹ Loosen the low pressure vent valve bracket retaining hardware (two button head bolts).
- ❺ Disconnect the 1/8 in. swage and DH200 connections on the pressure tube between the 1/8 in. swage tee and the inlet of the low pressure vent valve.
- ❻ Place a 1/8 in. swage cap (not supplied) on the open port of the 1/8 in. swage tee.
- ❼ Reapply drive air supply, connect electrical power and power on the PPCH.
- ❽ Use **[RANGE]** to make the Lo Q-RPT active (see Section 3.3.1).
- ❾ With the Lo Q-RPT active, perform a pressure decay based leak check (see Section 5.11.1).
- ❿ If the leak is no longer present then the low pressure vent valve is the cause of the leak and the valve should be replaced (see Section 5.12.1).

If the leak is still present, there is a leak that is not in the low pressure vent valve. Reconnect the original vent valve and proceed with additional leak testing to localize a leak within PPCH (see Section 5.11.2).

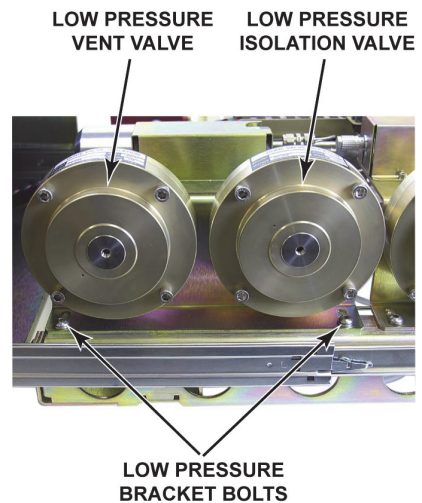

Step 4

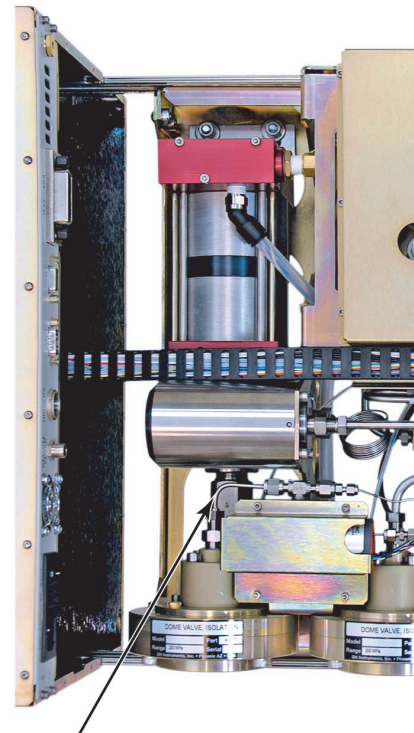

INLET OF LOW PRESSURE VENT VALVE TO 1/8 IN. SWAGE TEE CONNECTION

Step 5

5.12 VALVE REPLACEMENT OR REPAIR

5.12.1 SHUTOFF VALVE REPLACEMENT

○ PRINCIPLE

PPCH has up to three pneumatically operated shut off valves (see Section 5.14.2). Every PPCH has a TEST vent valve. PPCH's equipped with a Lo Q-RPT also have a Lo Q-RPT shutoff valve and a Lo Q-RPT vent valve. If a PPCH shutoff valve is leaking, it must be replaced. See Section 5.10.4 for information on leak checking PPCH and isolating the leak to a shutoff valve.

○ PROCEDURE

The procedure to replace a PPCH shutoff valve is the same for all three valves. To replace a shutoff valve, proceed as follows:

- ❶ Vent the PPCH and disconnect electrical power and drive air supply.
- ❷ Open PPCH chassis to gain access to the mechanical module (see Section 5.9).
- ❸ Using a 1/2 in. wrench, loosen the two DH200 high pressure connections on the valve.
- ❹ Remove the plastic 1/8 in. PFA tubing from the valve body by pressing down on the push lock fitting and gently pulling on the tube.
- ❺ **If the valve is the vent valve**, you must also remove the DH500 high pressure fitting attached to the Hi Q-RPT or utility sensor and disconnect the cable from the cable harness of the Hi Q-RPT or utility sensor.
- ❻ Remove the valve bracket retaining hardware (two button head bolts).

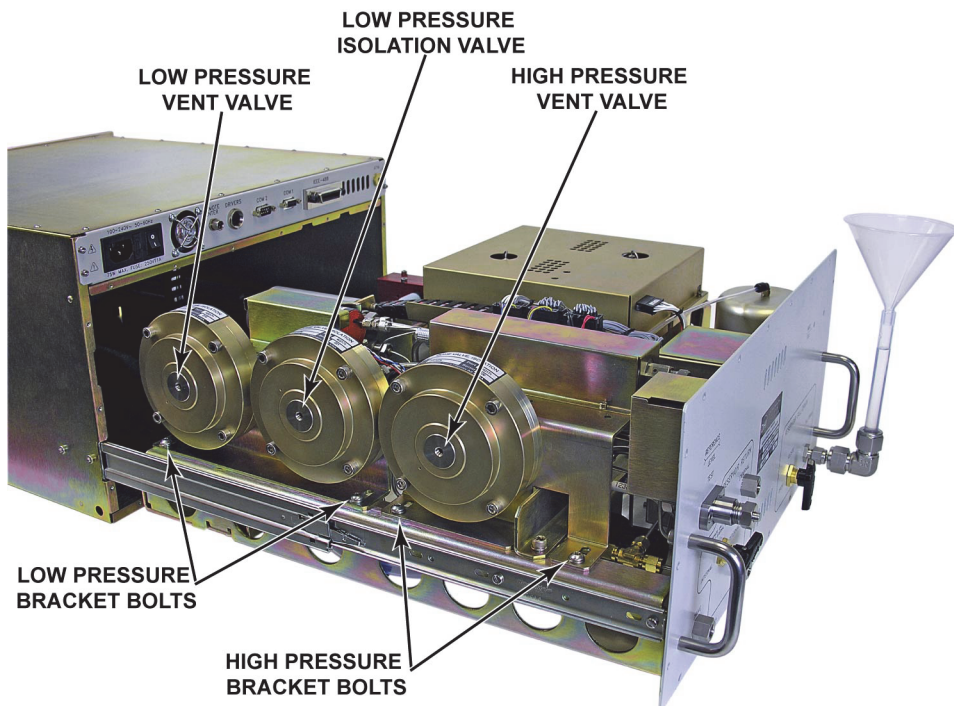

Step 6

- ⑦ Remove the valve from the bracket by removing the two mounting bolts.
- ⑧ To replace the valve, valve simply reverse the order of operations. Use valve p/n 402171.
- ⑨ Close PPCH chassis (see Section 5.9).
- ⑩ Leak test the PPCH to verify that valve replacement corrected the leak (see Section 5.11.1).

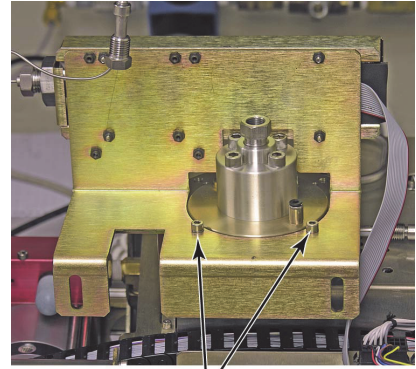

VALVE
MOUNTING BOLTS

Step 7

5.12.2 CONTROL VALVE SERVICE

The servo controlled valves that are used to set ascending and descending pressure ramps to control pressure in a PPCH (see Sections 5.14.2.11, 5.11.2), are not serviceable by the user. If you have concluded that there is a malfunction with a control valve of your PPCH, contact a DHI Authorized Service Provider (see Table 31).

5.13 RELOADING EMBEDDED SOFTWARE INTO FLASH MEMORY

PPCH uses FLASH memory. This allows the embedded software that controls PPCH operations and functions to be loaded into PPCH over its COM1 port from a computer with a simple FLASH loading utility program.

To replace corrupted software or upgrade your software, access the **DHI** worldwide web site at www.dhstruments.com and go to **SOFTWARE**. A FLASH loading utility and the latest release of PPCH software are available for download at no charge. If you do not have access to the web or have difficulty downloading or loading software, contact your **DHI** representative or a **DHI** Authorized Service Provider for assistance.

If you believe you have discovered an error or “bug” in PPCH software, please report it with complete details by email to cal.repair@dhstruments.com or submit an on-line **Quality Feedback Report** at www.dhstruments.com.



The DHI flash software loading utility (WinFlash) and PPCH embedded software are available for download from DHI web site, www.dhstruments.com.

5.14 SUBASSEMBLY DESCRIPTION AND LOCATION

PPCH consists of two modules. The electronic module is mounted on the top of the unit (see Section 5.14.1). The mechanical module (see Section 5.14.2) is beneath the electronic module.

5.14.1 ELECTRONIC MODULE

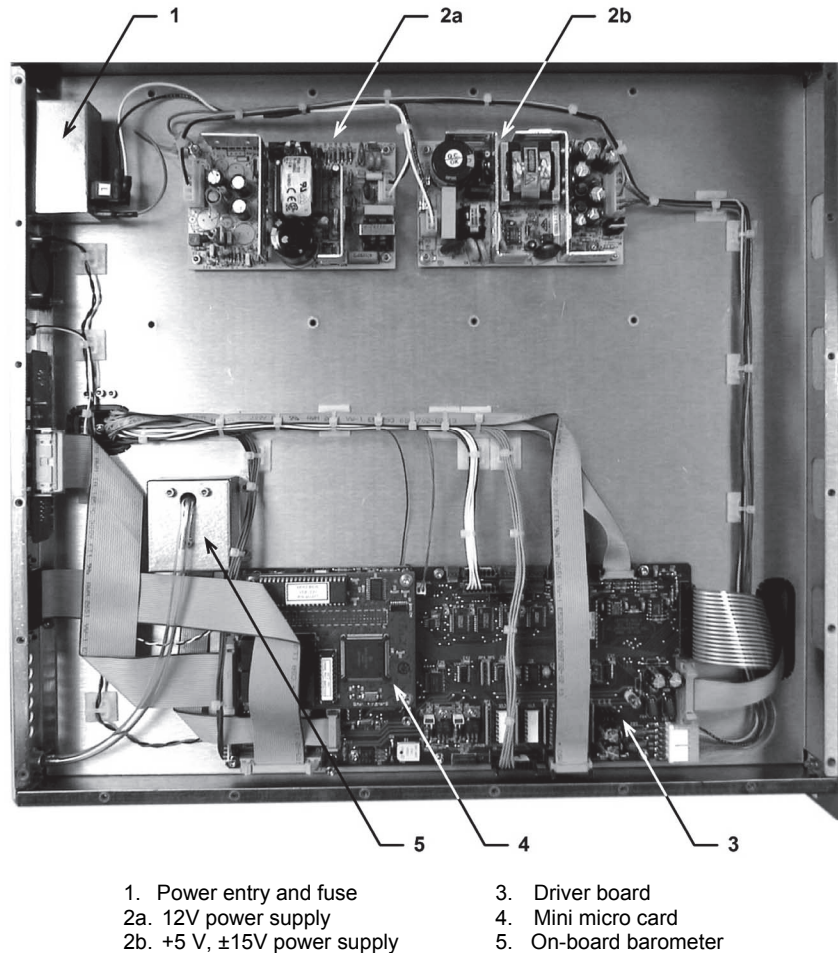

Figure 21. Electronic module, internal view

5.14.1.1 POWER ENTRY AND FUSE

Electrical Power Connector (IEC-320-C13) and main fuse.
Fuse: 1 A, 250 VAC fuse, 5 x 20 mm, time lag type

5.14.1.2 POWER SUPPLIES

+12 V DC ($\pm 2\%$) @ 3.3 Amps: For internal and external solenoid valve actuation, thermal pressure control unit (TPCU), servo-controlled valve stepping motor supply.

+5 V DC ($\pm 1\%$) @ 3.0 Amps; + 15 V DC ($\pm 3\%$) @ 2.0 Amps; -15 V DC ($\pm 3\%$) @ 0.35 Amps: For the supply of the micro board and driver board electronics.

Internal power supply fuse not replaceable by operator: 2A, 250 V (UV 440-2 power supply). 3.15A, 250 V (NFS40-7612 power supply).

5.14.1.3 DRIVER BOARD

The driver board is controlled by the mini micro board (see Section 5.14.1.4). It supports:

- 12 V drivers for internal and external solenoid valve actuation
- Frequency counters (2) for Q-RPTs (see Section 5.14.2.2)
- On-board barometer power and output (see Section 5.14.1.5)
- Pump drive air pressure transducer power and output (see Section 5.14.2.1)
- Utility sensor (if present) power and output
- Power to the electrical system cooling fan
- Power to thermal pressure control unit (TPCU) (see Section 5.14.2.15)
- Power to and control of servo-valve stepping motors (see Section 5.14.2.11)
- Fluid reservoir level detector
- Remote [ENT]
- Keypad and display
- Beeper

5.14.1.4 MINI MICRO BOARD

The micro board supports a Motorola 68302 micro-controller, EPROM, EEPROM, 128k x 16 bit NVRAM, 8 Mbit flash memory; RS-232 and IEEE-488.2 communications; keypad and display control. An I/O port controls other ports and devices in PPCH.

5.14.1.5 ON-BOARD BAROMETER

The on-board barometer supports a board mounted, barometric range, micromachined silicon sensor and an ambient temperature sensor. The barometer readings are used for dynamic atmospheric pressure compensation when measuring gauge pressure (see Section 3.2.4). The temperature sensor is used for temperature compensation of the barometric sensor.

5.14.2 MECHANICAL MODULE

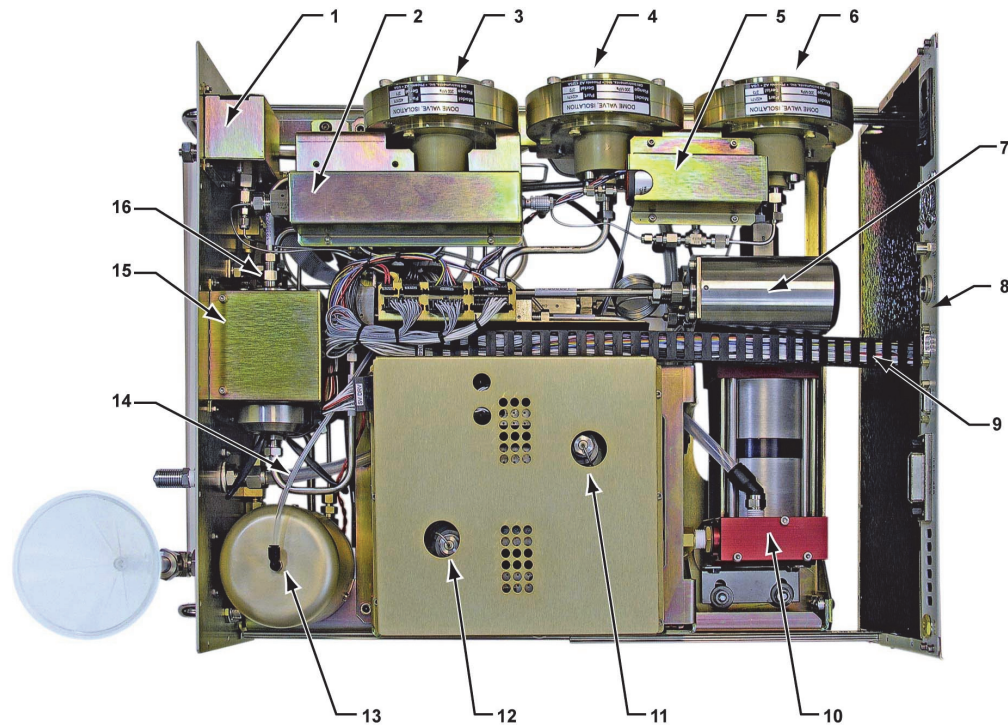

- | | |
|--|---|
| 1. Pump drive air pressure transducer | 10. Hydropneumatic pump |
| 2. Hi Q-RPT or utility sensor | 11. Inlet valve, servo-controlled |
| 3. TEST vent valve | 12. Outlet valve, servo-controlled |
| 4. Lo Q-RPT shutoff valve (optional) | 13. Fluid reservoir |
| 5. Lo Q-RPT (optional) | 14. Reservoir overflow/external reservoir return tube; pump drive out gas exhaust port (under overflow return tube) |
| 6. Lo Q-RPT vent valve (optional) | 15. Thermal pressure control unit (TPCU) |
| 7. Pump accumulator | 16. Drive pressure regulator (not visible) |
| 8. Front panel | |
| 9. Electrical cable track (to electronic module) | |

Figure 22. Mechanical module, internal view

5.14.2.1 PUMP DRIVE AIR PRESSURE TRANSDUCER

The pump drive air pressure transducer is a board mounted, 700 kPa (100 psi) range, micromachined silicon sensor and an ambient temperature sensor. The transducers readings are used to indicate the drive air pressure to the hydropneumatic pump (see Section 5.14.2.10). The temperature sensor is used for temperature compensation of the pressure sensor.

5.14.2.2 HI Q-RPT OR UTILITY SENSOR

The higher range pressure transducer in a PPCH may be a Q-RPT (quartz reference pressure transducer) or a utility sensor depending on the specified PPCH configuration.

A Q-RPT is intended to provide very high precision, low uncertainty, traceable pressure measurement. The basic sensing principle is the measurement of the change in the natural oscillating frequency of a quartz tuning fork. Changes in temperature and mechanical stress result from the change in pressure applied to a connecting bellows or bourdon tube. Two independent quartz elements are used. One quartz element is subjected to pressure related stress. The other quartz element is used only to monitor temperature. See Section 1.2.2.1 for Q-RPT specifications.

The utility sensor is for pressure indication, safety and housekeeping functions. It is a temperature compensated micro-machined silicon sensor module or a strain gauge transducer.

5.14.2.3 TEST VENT VALVE

Open/close need valve. The valve is normally closed by the force of two Belleville washer. It is opened by an opposing force applied by pneumatic pressure on a bladder.

5.14.2.4 LO Q-RPT SHUTOFF VALVE

Same as the test vent valve (see Section 5.14.2.3).

5.14.2.5 LO Q-RPT

PPCH may be equipped with a Lo Q-RPT. The Lo Q-RPT provides a lower measurement range than the Hi Q-RPT or utility sensor. See Section 5.14.2.2 for a description of Q-RPTs and Section 1.2.2.1 for complete Q-RPT specifications.

5.14.2.6 LO Q-RPT VENT VALVE

Same as the test vent valve (see Section 5.14.2.3).

5.14.2.7 PUMP ACCUMULATOR

High pressure stainless steel volume of approximately 40 cc.

5.14.2.8 FRONT PANEL

Sheet metal with inlaid overlay panel on which a membrane switch keypad and electro-luminescent display are mounted.

5.14.2.9 ELECTRICAL CABLE TRACK

Articulated track to organize various cables connecting between the PPCH's lower mechanical unit and upper electrical unit. The track is articulated so that the mechanical unit can slide out.

5.14.2.10 HYDROPNEUMATIC PUMP

The pump is a pneumatically powered, gate valve controlled, piston pump similar to a double-acting pneumatic cylinder. The pump pistons have a nominal ratio of 400:1 (PPCH-200, PPCH-100) or 200:1 (PPCH-140, PPCH-70) between the pneumatic piston and hydraulic plunger depending on PPCH model. Drive pressure to the pump is controlled by the drive pressure regulator (see Section 5.14.2.16). The pump operates continuously until the pneumatic drive pressure on the pneumatic piston is in equilibrium with the oil pressure on the oil plunger.

5.14.2.11 INLET CONTROL VALVE

Highly progressive needle valve. The valve is operated by a stepping motor and drive belt.

5.14.2.12 OUTLET CONTROL VALVE

Same as inlet control valve (see Section 5.14.2.11)

5.14.2.13 FLUID RESERVOIR

Aluminum reservoir of approximately 300 cc capacity designed to be pressurized to 100 kPa relative (15 psig) pressure.

5.14.2.14 RESERVOIR OVERFLOW/EXTERNAL RESERVOIR RETURN TUBE

1/4 in. PFA tube.

5.14.2.15 THERMAL PRESSURE CONTROL UNIT (TPCU)

High pressure volume containing a helicoidal heating element. The TPCU is used for fine pressure control in dynamic control mode (see Section 3.2.2.2).

5.14.2.16 DRIVE PRESSURE REGULATOR

Factory set pneumatic regulator that regulates the pressure connected to the **DRIVE** port and supplies the PPCH pneumatic system for pump air drive, pneumatically operated valve actuation and reservoir pressurization for pump priming.

NOTES

6. TROUBLESHOOTING

PPCH is a sophisticated pressure setting and measuring instrument with advanced on-board features and functions. Before assuming that unexpected behavior is caused by a system defect or breakdown, the operator should use this manual and other training facilities to become thoroughly familiar with PPCH operation. This troubleshooting guide is intended as an aid in identifying the reason for PPCH behavior and determining whether the behavior is normal operation or an internal or external problem.

Identify the symptom or unexpected behavior you are observing from the **SYMPTOM** list below. A **PROBABLE CAUSE** is provided and a **SOLUTION** is proposed including references to manual sections that provide information that may be of assistance.

Table 27. Troubleshooting guide

SYMPTOM	PROBABLE CAUSE	SOLUTION
Will not power up.	Blown fuse.	Replace fuse. 1.2.1
Cannot access certain functions > ACCESS RESTRICTED <	User level restricts access to certain functions.	Change user level or consult system manager. 3.5.5.5
Displays < FATAL ERROR > or < FATAL FAULT >.	Encountered unresolved internal software conflict.	Please record conditions leading up to event including the numbers displayed when [ENT] is pressed and report to your DHI Authorized Service Provider. Cycle power to clear. Table 31
Front panel keys seem to be disabled.	< remote > command has been sent from a host computer.	Send < local > command from host computer or cycle PPCH power. 4, 4.4.4
External RPM4 is not being identified when PPCH is powered up or [RPT] is pressed. PPCH is unable to find external RPM4 and Q-RPT.	The RPM4 COM1 port settings are not correct.	Set RPM4 COM1 port to settings required for use with PPCH. 2.3.9.1, RPM4 Operation and Maintenance Manual
Measured pressure display has too much/not enough resolution.	Resolution setting needs to be changed.	Use RES function to change the resolution setting. 3.4.2
Can't increase resolution to level desired in AutoRanged range.	Resolution setting is limited when AutoRanging under 10 % of Q-RPT default range.	Operation is normal. Table 9
Values that should be non-zero are displayed as zero.	Resolution setting needs to be increased to view significant digits.	Use RES function to change the resolution setting. 3.4.2
The pressure units available under the [UNIT] function key are not the ones desired.	UNIT function needs to be customized.	Use PresU function to customize the UNIT function or reset units to default. 3.5.6
Front panel display is dim.	Screen saver option has activated.	Operation is normal. Press any key to resume full screen power. Adjust screen saver time, if desired. 3.5.5.1
AutoRange is not selecting the desired Q-RPT for the specified range.	The external (RPM4) Q-RPT is not initialized.	Check that the external RPM4 is connected and initialized properly. 2.3.9.1, 3.3.5
	The Q-RPT range does not cover the desired AutoRange.	Check that Q-RPT default range is high enough to cover the AutoRange. Table 1
	The measurement mode specified by AutoRange is absolute and absolute mode is OFF for the desired Q-RPT.	Check that absolute/ mode is ON for the Q-RPT. 5.3.5
There is a < C > to the right of the < D >, < d >, < S >, < M > or < R > control mode character on the bottom line of the display and it won't go away.	The custom control function has been used.	Reset control parameters to default by selecting a control mode using the CONTROL function. 3.4.6.2

SYMPTOM	PROBABLE CAUSE	SOLUTION
Pressure display is flashing and beeper is sounding intermittently.	Current upper limit of active range has been exceeded.	Correct overpressure condition. Change UL and/or active range if needed. 3.4.4, 3.4.4.1, 3.3.1
Pressure display is flashing, no beeper is sounding and direct pressure control keys are inactive.	PPCH and/or external RPM4 has been over-pressured.	Correct the overpressure condition and cycle power ON and OFF. 3.4.4.1
Display is <Check Xaa aaa RPT, wdog: nnnnn uuuuu> and pressure control is aborted.	PPCH internal watchdog measurement system has detected that active external Q-RPT does not appear to be connected as its pressure is not changing as expected when PPCH controls the pressure.	Check that external RPM4 Q-RPT is connected properly to PPCH TEST port. Cycle PPCH power and retry. 2.3.9.1
A <i>Ready</i> (green) indication is never achieved.	Control parameter settings are too tight and/or existing conditions will not allow <i>Ready</i> to be achieved.	Adjust control parameters or correct other conditions. 3.4.6.1, 3.2.3, 3.2.2
Dynamic control is being used and it takes too long to get a <i>Ready</i> condition or the <i>Ready</i> condition is not maintained long enough.	System connected to PPCH TEST port has leaks or has a volume that is too large.	Try using "hi volume" dynamic pressure control mode. 3.4.6.2, 3.2.2.2
Cannot select absolute measurement mode.	Absolute measurement mode has been turned OFF in the calibration function.	Turn absolute mode ON. 5.3.5
Will not accept pressure command.	Target exceeds UL and/or current range.	Check UL, range and measurement mode. 3.4.4, 3.3.1, 3.3.3
Will not generate pressure.	Pump drive pressure supply not connected, incorrectly connected or not adequate.	Correct pressure supply. Observe pump drive air pressure. 2.3.5, 3.5.7.3
	There is a very large leak in the test system or TEST port is not connected.	Correct leak. 2.3.8, 3.3.9
	Very large test volume.	Operation is normal. Wait for pressure to generate.
	Excessive gas in test system.	Purge gas from test system prior to attempting to generate a pressure. 2.4.4
	Pump has lost its prime and is pumping air.	Turn PPCH power OFF to stop pump. Check reservoir fluid level and fill if necessary. Reprime pump. 5.6, 5.10.1
Pump is pumping rapidly and not generating pressure	Pump spool valve is not operating properly as evidenced by continuous gas flow through spool valve.	Service pump spool valve. 5.10.3
	Pump has lost its prime and is pumping air.	Cycle PPCH power OFF to stop pump. Check reservoir fluid level and fill if necessary. Reprime pump. 5.10.1
	Pump cannot draw fluid from the reservoir due to clogged pump drive inlet filter (usually due to contaminated or degraded fluid).	Replace pump drive inlet filter. 5.10.4
	Very large test volume.	Operation is normal. Wait for pressure to generate.
Pump pumps unexpectedly and/or continues to pump/flutter after pressure generation is complete.	Excessive gas in test system.	Purge gas from test system prior to attempting to generate a pressure. 2.4.4
	Flow of drive air to the PPCH DRIVE port is inadequate.	Improve flow of drive air to the DRIVE port by increasing diameter of tubing between pressure source and PPCH, reducing length of drive air supply tube, increasing flow rate of compressor, increasing compressor storage tank size. 2.3.5
	Leak between pump high pressure output and inlet control valve.	Examine pressure circuit and tighten fittings if necessary. 5.9
	Pump high pressure seals failing as evidenced by liquid output or mist from the pmp muffler.	Replace pump. 5.10.2

SYMPTOM	PROBABLE CAUSE	SOLUTION
Cannot get to maximum pressure... pump stops pumping	Pump drive pressure supply not connected, incorrectly connected or not adequate.	Correct pressure supply. Observe pump drive air pressure. 2.3.5, 3.5.7.3
	Pump high pressure seals failing as evidenced by liquid output or mist from the pmp muffler.	Replace pump. 5.10.2
PG7302 piston drop rate is unusually high when used with PPCH.	Leak in PPCH.	Identify and correct leak. 5.11, 5.11.2
Pressurized fluid dripping from PPCH enclosure.	PPCH internal leak to outside.	Open cabinet and look for visible leaks. Tighten fittings if necessary. If liquid is coming from pump muffler, replace pump. 5.9, 5.10.2
Poor pressure control characterized by control interrupting near the target pressure.	Control mode is set to static mode rather than dynamic mode.	Set control mode to dynamic. 3.2.2, 3.4.6.2
Poor pressure control characterized by pressure never stopping.	Control mode is set to monotonic or ramp mode rather than dynamic or static mode.	Set control mode to dynamic or static. 3.2.2, 3.4.6.2
[ENT] from main run screen doesn't result in a target pressure entry screen.	Control mode is set to ramp mode rather than dynamic, static or monotonic.	Set control mode to desired mode. 3.2.2, 3.4.6.2
Poor pressure control characterized by excessive overshooting/undershooting and/or "hunting" around target in dynamic control mode.	There is a restriction in the test connection between the PPCH and the test or the PPCH, the RPM4 and the test.	Remove the restriction to allow free flow between the PPCH, the RPM4 (if present) and the test. 2.3.9
	Thermal pressure control (TPC) module needs to be reconfigured.	Reconfigure TPC module after all other possible control issues are considered. 5.7
	Test volume has recently been changed significantly.	Set pressure points and allow PPCH to adapt to the new volume or run the TPCU configuration. 5.14.2.15
Poor pressure control characterized by overshooting target.	The volume connected to the TEST port is too small.	Add volume to the system connected to the TEST port. 1.2.3
Poor pressure control characterized by very slow slew rate.	A filter in the PPCH or an accessory is dirty and causing a restriction.	Replace the filter element.
	Test volume is too large. Severe restriction in a test line.	Reduce test volume if slew rate is unacceptable. Remove restrictions in line connected to TEST port.
	Pressure is below 1 MPa (150 psi) and PPCH uses a special control algorithm to avoid over pressuring poorly purged systems	Operation is normal. Wait for pressure to change.
Poor pressure control.	Excessive leak present in system.	Correct internal or external leak or increase hold limit. 3.3.9, 3.4.6.1
	Excessive gas in PPCH and/or test system.	Purge system. 3.3.8.2
Poor pressure control characterized by oscillating pressure.	Inlet and/or outlet control valve not closing fully.	Run valve opening point configuration. 5.8
	Inlet and/or outlet control valve leaking.	Perform leak checking routines, replace leaking valve. 5.11, 5.11.2
	System vent valve, Lo Q-RPT vent valve or Lo Q-RPT shutoff valve leaking.	Perform leak checking routines, replace leaking valve. 5.11, 5.11.2
Poor pressure control after recently changing to standard dynamic control mode.	Thermal pressure control unit (TPCU) is initializing and causes pressure to change as its temperature stabilizes.	Be sure PPCH is vented when changing to or from standard dynamic control mode and wait at least five minutes after the mode change before setting a new pressure target.
Disagreement between two Q-RPTs in system appears excessive.	Difference is actually within tolerance and is acceptable. Note the Internal, Hi transducer may be a utility sensor which has a much wider tolerance than a Q-RPT.	Compare differences observed to tolerances of Q-RPT and/or utility sensor measurements. 1.2.2.1, 1.2.2.2
Apparent inaccurate pressure control/measure and little or no response from Q-RPT or utility sensor.	Reference transducer destroyed by overpressure.	Contact DHI Authorized Service Provider. Table 31

SYMPTOM	PROBABLE CAUSE	SOLUTION
Apparent inaccurate pressure control/measure when using Internal, Hi (IH) RPT.	The IH transducer is a utility sensor, not a Q-RPT.	Operation is normal for lower specifications of utility sensor. 1.2.2.2
Apparent inaccurate pressure measurement/control.	Incorrect pressure units and/or measurement mode (gauge or absolute).	Set desired pressure units and/or measurement mode. 3.3.2, 3.3.3
	Q-RPT calibration coefficients have been altered.	Check and correct calibration coefficients if needed. 5.2, 5.3.7
	AutoZ has been run and turned ON with an incorrect standard for zero.	Check value of P _{offset} . Rerun AutoZ with a valid reference. 3.5.1
Apparent inaccurate pressure measurement/control and <h> is displayed on top line of screen.	An unplanned "head" correction is active or head height or fluid is incorrect.	Operation is normal. Remove or change "head" correction. 3.3.7
Pressure indication is negative.	Q-RPT is recovering from rapid depressurization.	Wait for Q-RPT recovery.
	Control mode was changed from dynamic to another mode while not vented.	It is preferable to be vented when changing measurement modes and to wait 5 minutes while vented when changing to or from dynamic control mode.
PPCH is vented but does not indicate zero.	Measurement mode is absolute and indication is absolute pressure at atmosphere which is not zero.	Check measurement mode setting. 3.3.3
	Measurement mode is gauge and AutoZ is OFF so PPCH is not rezeroing.	Turn AutoZ ON. 3.5.1
	Measurement mode is gauge and a head correction is applied. When the gauge pressure at the PPCH is zero, the gauge pressure at the level of the head is not zero.	Change the head correction if desired. 3.3.7
Will not vent.	VENT port is plugged.	Open VENT port to atmosphere.
	Vent valve not operating.	Contact DHI Authorized Service Provider. Table 31
	Drive air supply is too low to open vent valve.	Check drive air supply. Observe pump drive pressure. 2.3.5, 3.5.7.3
PPCH beeps rapidly ten times and/or bottom line of main run screen displays <Reservoir level low>.	The PPCH fluid reservoir is low and in danger of being empty.	Fill reservoir immediately. 5.6

7. APPENDIX

7.1 DRIVERS

The PPCH drivers option provides eight open collector drivers for operating external valves, solenoids, indicators, etc. When operating from the setup-driver screen (see Section 3.4.7), pressing **[ENT]** allows the **operating** mode of the drivers to be set. The two modes of operation are momentary and toggle. A **momentary** driver changes ON/OFF state while the corresponding driver number on the keyboard is being pressed. In **toggle** mode, the driver ON/OFF state toggles each time the corresponding key is pressed and released.

Each driver output can sink 500 mA at 12 V. However, the total output of all the activated drivers cannot exceed one Amp. Therefore, refer to Table 28 if multiple drivers are being activated simultaneously.

Table 28. External drivers current output

# OF ACTIVE DRIVERS	MAX CURRENT PER OUTPUT
1	500 mA
2	400 mA
3	275 mA
4	200 mA
5	160 mA
6	135 mA
7	120 mA
8	100 mA

The male connector (p/n 401382) for the **DRIVERS** port is delivered with the PPCH accessories.

Table 29 and Figure 23 should be referred to when building a cable to utilize the drivers port.

Table 29. External drivers pin outs

EXTERNAL DRIVERS		
PIN		DESCRIPTION
A	D1	Driver #1 (Open Collector)
C	D2	Driver #2 (Open Collector)
E	D3	Driver #3 (Open Collector)
G	D4	Driver #4 (Open Collector)
M	D5	Driver #5 (Open Collector)
J	D6	Driver #6 (Open Collector)
K	D7	Driver #7 (Open Collector)
L	D8	Driver #8 (Open Collector)
B		Drivers (+ 12 V)
D		Drivers (+ 12 V)
F		Drivers (+ 12 V)
H		Drivers (+ 12 V)

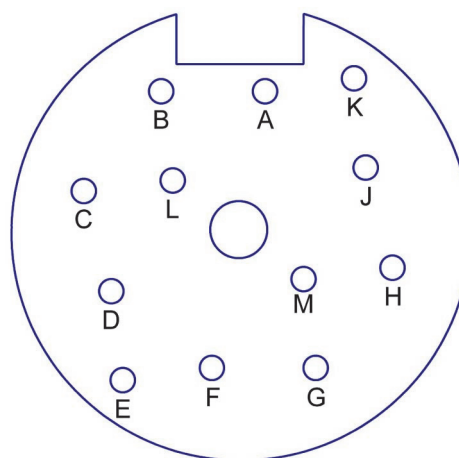

Figure 23. Drivers connector schematic

7.2 UNIT CONVERSION

7.2.1 PRESSURE

PPCH performs all internal calculations in SI units. Numerical values input or output in other units are converted to SI immediately after entry and back to other units just before output as needed.

Table 30 provides the conversion coefficients used by PPCH to convert numerical values expressed in SI units to corresponding values expressed in other units.

Table 30. Pressure unit of measure conversion coefficients

TO CONVERT FROM Pa To		MULTIPLY BY
Pa	<i>Pascal</i>	1.0
mbar	<i>millibar</i>	1.0 E-02
hPa	<i>hecto Pascal</i>	1.0 E-02
kPa	<i>kilo Pascal</i>	1.0 E-03
bar	<i>bar</i>	1.0 E-05
mmWa @ 4°C	<i>millimeter of water</i>	1.019716 E-01
mmHg @ 0°C	<i>millimeter of mercury</i>	7.50063 E-03
psi	<i>pound per square inch</i>	1.450377 E-04
psf	<i>pound per square foot</i>	1.007206 E-06
inWa @ 4°C	<i>inch of water</i>	4.014649 E-03
inWa @ 20°C	<i>inch of water</i>	4.021732 E-03
inWa @ 60°F	<i>inch of water</i>	4.018429 E-03
inHg @ 0°C	<i>inch of mercury</i>	2.953 E-04
kcm ²	<i>kilogram force per centimeter square</i>	1.019716 E-05
mTorr	<i>milliTorr (micron of mercury)</i>	7.50063
Torr	<i>Torr (millimeter of mercury)</i>	7.50063 E-3
User	<i>user</i>	User defined coefficient

7.3 REMOTE [ENT]

The PPCH remote ENTER function operates by detecting the open or closed status of the REMOTE ENTER switch.

The normal status of the ENTER switch is OPEN. When PPCH detects a CLOSED condition held for 300 ms, it is interpreted as equivalent to a press of the [ENT/SET P] key.

Any switch may be used to accomplish the remote ENTER function. The switch should be installed on the optional remote ENTER cable (DHI p/n 103128). Install the switch by connecting its two terminals to the black and white wires of the remote ENTER cable.

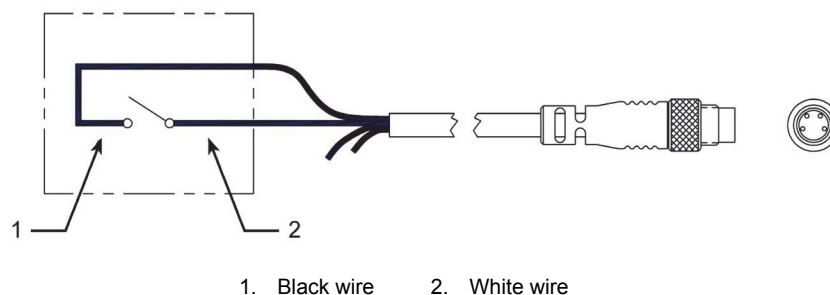

Figure 24. Remote [ENT/SET P] connector schematic

8. WARRANTY

8.1 LIMITED WARRANTY AND LIMITATION OF LIABILITY

Each Fluke product is warranted to be free from defects in material and workmanship under normal use and service. The warranty period is one year and begins on the date of shipment. Parts, product repairs, and services are warranted for 90 days. This warranty extends only to the original buyer or end-user customer of a Fluke authorized reseller, and does not apply to fuses, disposable batteries, or to any product which, in Fluke's opinion, has been misused, altered, neglected, contaminated, or damaged by accident or abnormal conditions of operation or handling. Fluke warrants that software will operate substantially in accordance with its functional specifications for 90 days and that it has been properly recorded on non-defective media. Fluke does not warrant that software will be error free or operate without interruption.

Fluke authorized resellers shall extend this warranty on new and unused products to end-user customers only but have no authority to extend a greater or different warranty on behalf of Fluke. Warranty support is available only if product is purchased through a Fluke authorized sales outlet or Buyer has paid the applicable international price. Fluke reserves the right to invoice Buyer for importation costs of repair/replacement parts when product purchased in one country is submitted for repair in another country.

Fluke's warranty obligation is limited, at Fluke's option, to refund of the purchase price, free of charge repair, or replacement of a defective product which is returned to a Fluke authorized service center within the warranty period.

To obtain warranty service, contact your nearest Fluke authorized service center to obtain return authorization information, then send the product to that service center, with a description of the difficulty, postage and insurance prepaid (FOB Destination). Fluke assumes no risk for damage in transit. Following warranty repair, the product will be returned to Buyer, transportation prepaid (FOB Destination). If Fluke determines that failure was caused by neglect, misuse, contamination, alteration, accident, or abnormal condition of operation or handling, including overvoltage failures caused by use outside the product's specified rating, or normal wear and tear of mechanical components, Fluke will provide an estimate of repair costs and obtain authorization before commencing the work. Following repair, the product will be returned to the Buyer transportation prepaid and the Buyer will be billed for the repair and return transportation charges (FOB Shipping Point).

THIS WARRANTY IS BUYER'S SOLE AND EXCLUSIVE REMEDY AND IS IN LIEU OF ALL OTHER WARRANTIES, EXPRESS OR IMPLIED, INCLUDING BUT NOT LIMITED TO ANY IMPLIED WARRANTY OF MERCHANTABILITY OR FITNESS FOR A PARTICULAR PURPOSE. FLUKE SHALL NOT BE LIABLE FOR ANY SPECIAL, INDIRECT, INCIDENTAL, OR CONSEQUENTIAL DAMAGES OR LOSSES, INCLUDING LOSS OF DATA, ARISING FROM ANY CAUSE OR THEORY.

Since some countries or states do not allow limitation of the term of an implied warranty, or exclusion or limitation of incidental or consequential damages, the limitations and exclusions of this warranty may not apply to every buyer. If any provision of this Warranty is held invalid or unenforceable by a court or other decision-maker of competent jurisdiction, such holding will not affect the validity or enforceability of any other provision.

Fluke Corporation
P.O. Box 9090
Everett, WA 98206-9090
U.S.A.

Fluke Europe B.V.
P.O. Box 1186
5602 BD Eindhoven
The Netherlands

11/99

Table 31. DHI Authorized Service Providers

DH INSTRUMENTS, A FLUKE COMPANY AUTHORIZED SERVICE PROVIDERS			
COMPANY	ADDRESS	TELEPHONE, FAX & EMAIL	NORMAL SUPPORT REGION
DH Instruments, a Fluke Company	4765 East Beautiful Lane Phoenix AZ 85044-5318 USA	Tel 602.431.9100 Fax 602.431.9559 cal.repair@dhinstruments.com	Worldwide
Minerva Meettechniek B.V.	Chrysantstraat 1 3812 WX Amersfoort the NETHERLANDS	Tel (+31) 33.46.22.000 Fax (+31) 33.46.22.218 info@minervaipm.com	European Union
Ohte Giken, Inc. Technology Center	258-1, Nakadai, Kasumigaura-machi, Niihari-Gun Ibaraki, 300-0133 JAPAN	Tel 81.29.840.9111 Fax 81.29.840.9100 tech@ohtegiken.co.jp	Japan/Asia
DH Products Technical Service Division	National Institute of Metrology Heat Division Pressure & Vacuum Lab NO. 18, Bei San Huan Donglu Beijing 100013 PR CHINA	Tel 010.64291994 ext 5 Tel 010.64218637 ext 5 Fax 010.64218703 cxcen@mx.cei.gov.cn	Peoples Republic of China

NOTES

9. GLOSSARY

Axxx	A type of Q-RPT with a built-in vacuum reference that is intrinsically absolute (e.g. A10M). In PPCH, Axxx Q-RPTs support absolute and gauge measurement modes.
Absolute Mode	Measurement mode in which the Q-RPT indicates absolute pressure (difference from vacuum).
AutoRange	A function that optimizes PPCH measurement and control for a specific, user defined range of operation.
AutoRanged Range	A PPCH range created using the AutoRange function.
AutoTest or ATest	PPCH on-board automated testing sequences and their results.
AutoZero or AutoZ	A process by which a Q-RPT and measurement mode is zeroed (offset) relative to a standard.
Barometer	PPCH's on-board atmospheric pressure measuring sensor. Also referred to as on-board barometer.
Control Mode	Type of automated pressure control (static, dynamic, monotonic or ramp).
Control Parameters	Parameters affecting pressure control and the <i>Ready/Not Ready</i> determination (target, target limit, hold limit, stability limit, rate limit).
Custom Control	Automated pressure control in which the control parameters are not the default control parameters.
Default Range (DF)	A Q-RPT or utility sensor's maximum range that is always available on [RANGE] and cannot be deleted.
Deviation	The deviation of the current pressure from the target pressure control value. Indicated in MAIN RUN screen when in dynamic control mode.
DUT	Device Under Test. The device or devices pneumatically connected to the PPCH TEST port that the PPCH is being used to test or calibrate.
Dynamic Control	Control mode in which the pressure is constantly adjusted to remain as close as possible to the target value.
External device or External Q-RPT	A Q-RPT in an RPM4 external to PPCH used by PPCH for precise pressure measurement.
FS	Abbreviation of "full scale". The full scale value is the maximum pressure or the span of a measurement range. Limits and specifications are often expressed as % FS.
Gauge Mode	Measurement mode in which the Q-RPT indicates gauge pressure (difference from atmospheric pressure), but only in the positive direction (above atmosphere).
Head	A difference in height between the PPCH reference level and the DUT.
Hold Limit	An automated pressure control parameter. Maximum acceptable difference between the current pressure and the target pressure value.
IH or IuH	Internal, Hi. The Q-RPT (IH) or utility sensor (IuH) internal to PPCH if there is only one or, if there are two, the one that has the highest full scale default range.
IL	Internal, Lo. Refers to a Q-RPT internal to the PPCH that is the lower of the two if there is a second Q-RPT or utility sensor in the PPCH.
Measurement Mode	Whether pressure is being measured relative to absolute zero or vacuum (absolute mode) or relative to atmospheric pressure (gauge mode).
Monotonic Control Mode	Automated pressure control mode in which pressure is set to a target value and then controlled at a low rate of change in the same direction as the as the pressure set.
P_{offset}	The difference between a Q-RPT reading and the AutoZero reference at the time AutoZ is run. Used by the AutoZ function when Auto Z is ON to compensate Q-RPT readings for changes in zero over time.
P_{std,0}	AutoZero reference value. Value indicated by the device against which the Q-RPT is zeroed by AutoZ.

PA	Pressure adder, used to offset a Q-RPT, utility sensor or barometer to calibrate it.
PM	Pressure multiplier, used to adjust span of a Q-RPT, utility sensor or barometer to calibrate it.
Q-RPT (Reference Pressure Transducer)	<ol style="list-style-type: none"> The transducer used by PPCH for low uncertainty pressure measurement. The Q-RPT in a single Q-RPT PPCH, or the higher pressure range Q-RPT in a dual Q-RPT PPCH, is referred to as the Hi Q-RPT. The lower pressure range Q-RPT in a dual Q-RPT PPCH is referred to as the Lo Q-RPT. <p>PPCH Q-RPTs are designated by a leading A (absolute) followed by three numbers and a letter indicating the maximum range of the Q-RPT in MPa (nnnM).</p>
Ramp Control Mode	Automated pressure control mode in which pressure is set and maintained at a target rate of change
Rate	The rate of change of the current measured pressure. Indicated in the MAIN RUN screen when control is suspended and in certain phases of automated pressure control.
Ready/Not Ready	Indication used to indicate when control PPCH pressure meets specific behavior criteria. <i>Ready/Not Ready</i> is indicated by an LED on the PPCH front panel and is used to determine when test readings should be taken.
RPM4	Reference Pressure Monitor manufactured by DHI . RPM4s can be set up to act as external measurement devices to operate with PPCH.
Span	The difference between FS and the lowest point in a range.
Stability Limit	A limit expressed in units of pressure per second (e.g., kPa/second). The stability limit is used as the <i>Ready/Not Ready</i> criterion. <i>Ready</i> if rate of change is less than stability limit. <i>Not Ready</i> if rate of change is greater than stability limit.
Static Control	Control mode in which the pressure is set near the target value and then shut OFF and allowed to evolve freely.
Target Pressure	The value to which dynamic, static and monotonic automated pressure control sets the pressure.
UL	Same as Upper Limit.
Upper Limit	A range specific maximum value of pressure not be exceeded and at which PPCH will abort pressure setting and beep.
Utility Sensor	The internal, high (luH) transducer in a PPCH if when there is no Q-RPT in the IH position. A utility sensor is a low accuracy pressure transducer used for pressure indication, safety and housekeeping functions, not for low uncertainty measurement.
User Level	Levels of security that can be set to protect certain PPCH functions from being accessed.
QDUT	On-board automated test sequence that AutoRanges PPCH based on characteristics of the Device Under Test (DUT).
QTEST	Automated test sequence set up and executed using current PPCH settings.
X1H, X1L, X2H, X2L	<p>External 1, Hi; External 1, Lo; External 2, Hi; External 2, Lo. Position designators of Q-RPTs external to a PPCH (in RPM4s) that have been connected to PPCH and initialized so that they can be used by PPCH for pressure measurement.</p> <p>“1” is the first RPM4 in the communications daisy chain and “2” is the second.</p> <p>“Hi” is the Q-RPT in the RPM4 if there is only one or the one that has the highest full scale default range if there are two.</p> <p>“Lo” is the lower of the two Q-RPTs if there are two Q-RPTs in the RPM4.</p>