

FLUKE®

Calibration

RUSKA 7250, 7250i, 7250xi & 7250LP

Pressure Controller/Calibrator

Users Manual

LIMITED WARRANTY AND LIMITATION OF LIABILITY

Each Fluke product is warranted to be free from defects in material and workmanship under normal use and service. The warranty period is one year and begins on the date of shipment. Parts, product repairs, and services are warranted for 90 days. This warranty extends only to the original buyer or end-user customer of a Fluke authorized reseller, and does not apply to fuses, disposable batteries, or to any product which, in Fluke's opinion, has been misused, altered, neglected, contaminated, or damaged by accident or abnormal conditions of operation or handling. Fluke warrants that software will operate substantially in accordance with its functional specifications for 90 days and that it has been properly recorded on non-defective media. Fluke does not warrant that software will be error free or operate without interruption.

Fluke authorized resellers shall extend this warranty on new and unused products to end-user customers only but have no authority to extend a greater or different warranty on behalf of Fluke. Warranty support is available only if product is purchased through a Fluke authorized sales outlet or Buyer has paid the applicable international price. Fluke reserves the right to invoice Buyer for importation costs of repair/replacement parts when product purchased in one country is submitted for repair in another country.

Fluke's warranty obligation is limited, at Fluke's option, to refund of the purchase price, free of charge repair, or replacement of a defective product which is returned to a Fluke authorized service center within the warranty period.

To obtain warranty service, contact your nearest Fluke authorized service center to obtain return authorization information, then send the product to that service center, with a description of the difficulty, postage and insurance prepaid (FOB Destination). Fluke assumes no risk for damage in transit. Following warranty repair, the product will be returned to Buyer, transportation prepaid (FOB Destination). If Fluke determines that failure was caused by neglect, misuse, contamination, alteration, accident, or abnormal condition of operation or handling, including overvoltage failures caused by use outside the product's specified rating, or normal wear and tear of mechanical components, Fluke will provide an estimate of repair costs and obtain authorization before commencing the work. Following repair, the product will be returned to the Buyer transportation prepaid and the Buyer will be billed for the repair and return transportation charges (FOB Shipping Point).

THIS WARRANTY IS BUYER'S SOLE AND EXCLUSIVE REMEDY AND IS IN LIEU OF ALL OTHER WARRANTIES, EXPRESS OR IMPLIED, INCLUDING BUT NOT LIMITED TO ANY IMPLIED WARRANTY OF MERCHANTABILITY OR FITNESS FOR A PARTICULAR PURPOSE. FLUKE SHALL NOT BE LIABLE FOR ANY SPECIAL, INDIRECT, INCIDENTAL, OR CONSEQUENTIAL DAMAGES OR LOSSES, INCLUDING LOSS OF DATA, ARISING FROM ANY CAUSE OR THEORY.

Since some countries or states do not allow limitation of the term of an implied warranty, or exclusion or limitation of incidental or consequential damages, the limitations and exclusions of this warranty may not apply to every buyer. If any provision of this Warranty is held invalid or unenforceable by a court or other decision-maker of competent jurisdiction, such holding will not affect the validity or enforceability of any other provision.

Fluke Corporation
P.O. Box 9090
Everett, WA 98206-9090
U.S.A.

Fluke Europe B.V.
P.O. Box 1186
5602 BD Eindhoven
The Netherlands

11/99

To register your product online, visit register.fluke.com

7250 – Change Language

Hold **mode** key for 5 seconds

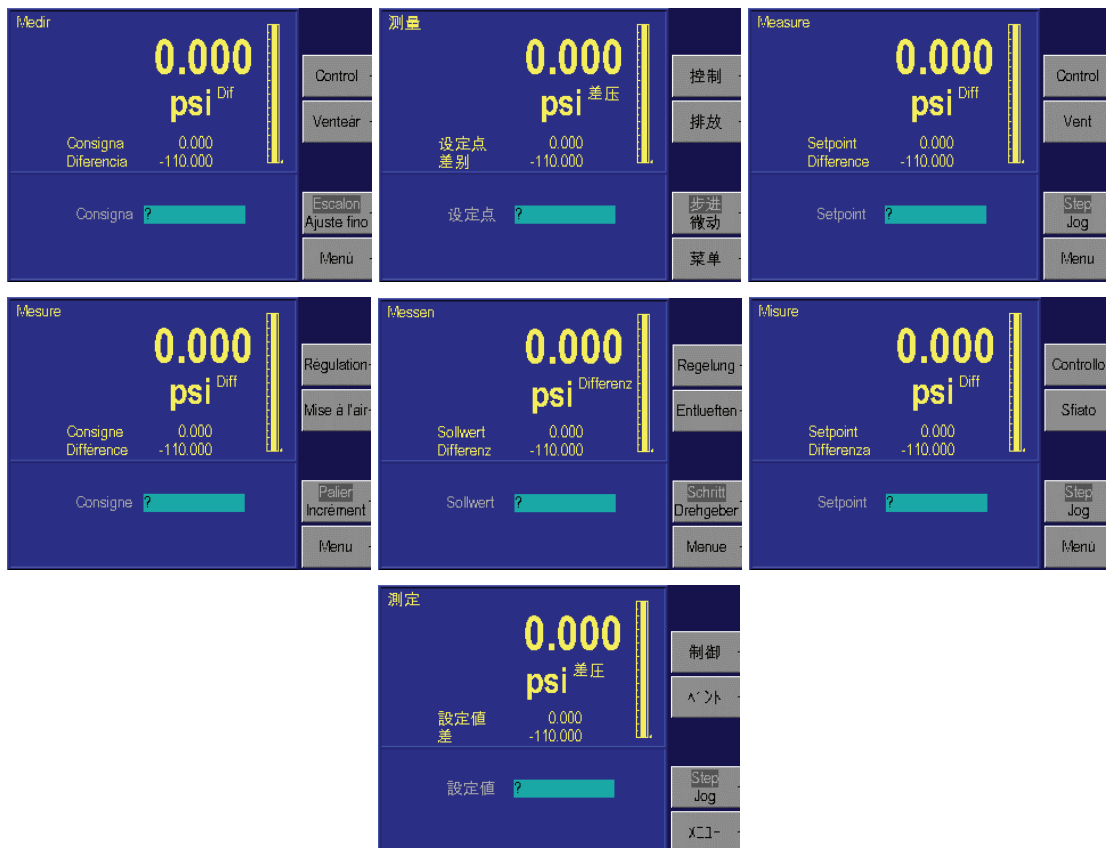
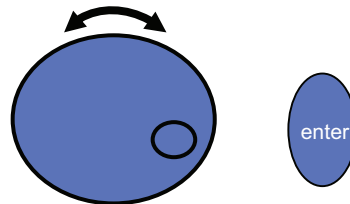

Table of Contents

Chapter	Title	Page
1	General Information	1-1
	Introduction.....	1-1
	How to Contact Fluke.....	1-1
	Safety Information	1-2
	Resuscitation.....	1-2
	Symbols Used in this Manual	1-3
	General Information.....	1-3
	Features.....	1-3
	Fused-Quartz Bourdon Tube Technology	1-3
	Mercury-Free	1-3
	NIST Traceability	1-3
	Universal Power Supply	1-4
	Measure While Control	1-4
	Friendly Display	1-4
	Adjustable Pressure Display.....	1-4
	Ease of Operation	1-4
	Modular Design	1-4
	Attractive Desktop Packaging	1-4
	Power-On Self Test	1-4
	Ease of Calibration	1-4
	Automatic Zero Adjust.....	1-4
	Automatic Head Correction.....	1-5
	Choice of Medium.....	1-5
	Choice of Display Units	1-5
	Communications Interface.....	1-5
	Standard Equipment and Options	1-5
2	Theory of Operation	2-1
	Introduction.....	2-1
	Power Supply.....	2-1
	Electronics Module	2-2
	Back-Plane Board.....	2-2
	Microprocessor Board	2-2
	Digital Control Board.....	2-3

IEEE-488 Interface	2-3
Front Panel.....	2-3
Pneumatics Module.....	2-4
Measure Mode Pneumatics.....	2-6
Reference Port.....	2-6
Test Port.....	2-6
Vent Procedure.....	2-7
Control Mode Pneumatics.....	2-7
Pressure Supply Port.....	2-7
Vacuum Supply (Exhaust) Port.....	2-7
Pressure Control.....	2-7
Control Strategy.....	2-7
Inner vs. Outer Loops.....	2-7
Normal Mode.....	2-8
Fast Mode.....	2-8
Alignment of Inner Loop with Outer Loop.....	2-8
PID Control.....	2-8
Transducer Module.....	2-9
Quartz Bourdon Tube Sensor (Transducer01).....	2-9
Sensor Board.....	2-10
Linearization Term.....	2-10
Auxiliary Sensors.....	2-11
Case Reference Vacuum Sensor.....	2-11
Software.....	2-11
Software Safety Controls.....	2-11
Preventing Operator Errors.....	2-11
Pneumatic Errors.....	2-11
Shut Offs.....	2-11
Oven Control.....	2-11
Pressure Reading and Correction.....	2-12
Zero Coefficients.....	2-12
Range Coefficients.....	2-13
3 Installation	3-1
Introduction.....	3-1
Unpacking the Calibrator.....	3-1
Cautions.....	3-2
Powering Up the Calibrator.....	3-2
Observing the Calibrator's Full Scale Rating.....	3-3
Pneumatic Connections.....	3-3
Pressure Supply Port.....	3-3
Exhaust Port.....	3-3
Absolute Models.....	3-3
Test Port.....	3-3
Reference Port.....	3-4
Vacuum Sensor—Option.....	3-5
4 Local Operation	4-1
Introduction.....	4-1
Numeric Keypad.....	4-1
Function Keys.....	4-1
Rotary Knob.....	4-1
Cancel, Previous.....	4-2
Tutorial.....	4-3

Selecting Language	4-5
Selecting Mode of Operation.....	4-5
Simulated Absolute Instruments	4-6
Absolute with Evacuated Reference—Optional for RUSKA 7250 & 7250i only	4-6
Main Menu.....	4-6
Controlling Pressure	4-7
Setting the Pressure Set-Point	4-7
Entering/Exiting Control Mode	4-7
Vent.....	4-8
Step/Jog.....	4-8
Stepping.....	4-8
Setting Step Size.....	4-8
Jogging	4-8
Menu	4-8
Menu Setup	4-9
Menu Setup—Limits	4-9
Menu Setup—User	4-12
Menu Setup—Units.....	4-14
Menu Setup—Remote	4-15
Menu Setup—System.....	4-16
Menu Calibrate	4-17
Calibration Password	4-17
Zeroing	4-17
Menu Program—Storing A Sequence in Memory.....	4-18
Preparing to Program	4-18
Entering a New Program.....	4-19
Automatically Generating a Program.....	4-20
Changing the Name of a Program	4-21
Changing an Existing Program	4-22
Changing the Configuration Stored with a Program	4-22
Running a Program	4-23
Menu Test.....	4-24
Menu Test—Sweep Test	4-25
Menu Test—Self Test	4-25
Menu Test—Remote Test	4-26
Menu Test—Shop1.....	4-26
Menu Test—Control.....	4-26
Menu Display.....	4-27
Menu Display—Blank.....	4-27
5 Remote Operation	5-1
Capabilities	5-1
IEEE-488	5-1
RS-232.....	5-2
Remote/Local Operation.....	5-2
Configuration.....	5-2
Device Messages.....	5-3
SCPI Command Format	5-3
SCPI Response Format.....	5-3
ANSI/IEEE 488.2-1987 Command Summary.....	5-4
SCPI Command Summary	5-4
Example SCPI Commands	5-6
SCPI Status Registers	5-7
6005 Interface Panel Emulation.....	5-9

Serial Operation	5-9
Druck DPI-510 Emulation Command Summary	5-9
Supported Commands	5-9
Response Formats.....	5-10
Reset Conditions.....	5-10
Notes.....	5-10
Format	5-10
Zeroing.....	5-10
Rate	5-10
Units	5-11
Sample Programs	5-11
Sample Program 1 - 7250 GPIB (IEEE-488)	5-11
Sample Program 2 - 7250 GPIB (IEEE-488)	5-13
Sample Program 3 - 7250 Serial (RS-232).....	5-16
Sample Program 4 - QBASIC	5-19
6 Maintenance.....	6-1
Introduction.....	6-1
Observing the Software Version Number	6-1
Preventive Maintenance.....	6-1
Initiating the RUSKA 7250's Self Test.....	6-1
Removing the Calibrator's Cover.....	6-2
Moisture Filter	6-3
Particle Filters.....	6-3
Vacuum Pumps.....	6-3
Processor Battery.....	6-3
Calibration	6-3
Calibration Instructions	6-4
Preparation	6-4
Storing the Coefficients.....	6-6
Vacuum (Negative Gauge) Calibrations.....	6-7
Barometric Reference Calibration - Simulated Absolute	6-8
Vacuum Sensor Calibration—Optional Case Reference Sensor	6-8
Editing the Calibration Coefficients.....	6-9
Zeroing	6-10
Gauge and Vacuum (Negative Gauge) Instruments.....	6-10
Permanent Absolute Instruments	6-11
RPT—Simulated Absolute Instruments.....	6-12
Sensor Photocell Zeroing.....	6-12
Mechanical Zero of the RUSKA 7250xi	6-14
Optimizing Control.....	6-15
Fan Operation	6-16
System Software Update Procedure.....	6-17
RUSKA 7250 Controller Software Upgrade	6-18
Replacement Parts.....	6-18
Cleaning.....	6-19
7 Preparation for Storage & Shipping	7-1
Introduction.....	7-1
Disconnecting the RUSKA 7250	7-1
Packing Instructions.....	7-1
Shipping Instructions.....	7-4
Appendices	
A Summary of Specifications	A-1
B Summary of Error Messages	B-1

List of Tables

Table	Title	Page
1-1.	Symbols.....	1-3
1-2.	RUSKA 7250 Options List	1-5
2-1.	Conversion Factors.....	2-3
2-2.	Solenoid Valves States	2-5
3-1.	General Specifications and Parameters	3-2
6-1.	Electronics Self Test	6-2
6-2.	RUSKA 7250 Parts	6-18
6-3.	RUSKA 7250 Additional Parts	6-19

List of Figures

Figure	Title	Page
2-1.	Calibrator Block Diagram	2-1
2-2.	RUSKA 7250 Gauge Pneumatics Diagram.....	2-4
2-2.	Model 7250 DPC Gauge Pneumatics Diagram, 5 to 2500 psig (34 kPa to 17.2 MPa) Full Scale Ranges.....	2-4
2-3.	RUSKA 7250 Absolute Pneumatics Diagram to 50 PSIA (340 kPa) FS.....	2-5
2-4.	RUSKA 7250 Absolute Pneumatics Diagram 3000 PSIA (20.7 MPa) FS	2-5
2-5.	Pressure Control.....	2-9
2-6.	Shaft/Magnet Section.....	2-10
2-7.	Photocell/Light Spot.....	2-10
2-8.	Menu Display - Menu.....	2-12
3-1.	RUSKA 7250 Back Panel	3-5
4-1.	RUSKA 7250 Front Panel.....	4-1
4-2.	Menu Tree	4-2
4-3.	Main Menu	4-3
4-4.	Units Menu.....	4-4
4-5.	Entering Pressure in the Main Menu.....	4-4
4-6.	Control Mode in Main Menu	4-5
4-7.	Mode Menu	4-6
4-8.	Functions in Main Menu	4-7
4-9.	Configurations in Menu	4-9
4-10.	Menu Setup - Menu.....	4-9
4-11.	Menu Setup Limits - Menu	4-10
4-12.	Menu Setup User - Menu.....	4-12
4-13.	Menu Setup Units - Menu	4-14
4-14.	Menu Setup Units Edit Name - Menu.....	4-15
4-15.	Menu Setup Remote - Menu.....	4-15
4-16.	Menu Setup System - Menu	4-16
4-17.	Menu Program - Menu	4-19
4-18.	Menu Program Edit - Menu.....	4-20
4-19.	Menu Program Edit Auto - Menu.....	4-21
4-20.	Menu Program Edit Name - Menu.....	4-21
4-21.	Menu Program Edit - Menu.....	4-22
4-22.	Menu Program Config - Menu	4-23
4-23.	Menu Program Run - Menu	4-24
4-24.	Menu Test - Menu	4-24

4-25.	Menu Test Sweep - Menu.....	4-25
4-26.	Menu Test Remote - GPIB Menu & Serial1 Menu	4-26
4-27.	Menu Test Shop1 - Menu	4-26
4-28.	Menu Test Controller - Menu.....	4-27
4-29.	Menu Display - Menu	4-27
6-1.	Menu Test Self - Menu.....	6-2
6-2.	Menu Calibration.....	6-4
6-3.	Vacuum Calibration	6-7
6-4.	Zeroing Menu.....	6-11
6-5.	Zero Set.....	6-11
6-6.	Photocell Zeroing Menu.....	6-13
6-7.	Centering the Photocell.....	6-13
6-8.	Correct Adjustment of Photocell Centering Bar	6-14
6-9.	Photocell Location	6-14
6-10.	Menu Test Control - Menu	6-15
6-11.	Auto-Tune Menu.....	6-16
6-12.	Menu Test Shop 1 - Menu	6-17
7-1.	Packing the RUSKA 7250.....	7-3

Chapter 1

General Information

Introduction

This manual contains operation and routine and preventive maintenance instructions for the RUSKA 7250, 7250i, 7250xi and 7250LP Pressure Controller/Calibrator (Calibrator) manufactured by Fluke. The manual will refer to all model numbers of the instrument listed above generically as the Calibrator. Therefore, the information contained in the manual will be applicable to all of the models of the 7250 unless it denotes that the information is only applicable to a specific model number. This section of the manual provides general information about the 7250 and presents its features and options.

How to Contact Fluke

To contact Fluke Calibration, call one of the following telephone numbers:

- Technical Support USA: 1-877-355-3225
- Calibration/Repair USA: 1-877-355-3225
- Canada: 1-800-36-FLUKE (1-800-363-5853)
- Europe: +31-40-2675-200
- Japan: +81-3-6714-3114
- Singapore: +65-6799-5566
- China: +86-400-810-3435
- Brazil: +55-11-3759-7600
- Anywhere in the world: +1-425-446-6110

To see product information and download the latest manual supplements, visit Fluke Calibration's website at www.flukecal.com.

To register your product, visit <http://flukecal.com/register-product>.

Safety Information

In this manual, a **Warning** identifies conditions and procedures that are dangerous to the user. A **Caution** identifies conditions and procedures that can cause damage to the Product or the equipment under test.

Warning

To prevent possible electrical shock, fire, or personal injury:

- Carefully read all instructions.
- Use the Product only as specified, or the protection supplied by the Product can be compromised.
- Replace the mains power cord if the insulation is damaged or if the insulation shows signs of wear.
- Do not use and disable the Product if it is damaged.
- Do not touch voltages >30 V ac rms, 42 V ac peak, or 60 V dc.
- Use this Product indoors only.
- Do not use the Product around explosive gas, vapor, or in damp or wet environments.
- Make sure the ground conductor in the mains power cord is connected to a protective earth ground. Disruption of the protective earth could put voltage on the chassis that could cause death.
- Use only the mains power cord and connector approved for the voltage and plug configuration in your country and rated for the Product.

Caution

- Electrostatic discharge sensitive (ESDS) applies to low power, solid-state parts which could be damaged or destroyed when exposed to discharges of static electricity. Maintenance personnel are often not aware that an ESDS part has been damaged or destroyed because electrostatic discharges at levels less than 4,000 volts cannot be seen, felt, or heard.





Resuscitation

Personnel working with or near dangerous voltages shall be familiar with modern methods of resuscitation. Such information may be obtained from your local American Medical Association.

Symbols Used in this Manual

Symbols used on the Calibrator and in this manual are explained in Table 1-1.

Table 1-1. Symbols

Symbol	Description
	This equipment meets the requirements of all relevant European safety directives. The equipment carries the CE mark.
	Earth Ground
	Important Information: refer to manual
	Shock Hazard
	Do not dispose of this product as unsorted municipal waste. Go to Fluke's website for recycling information.

General Information

The RUSKA 7250 uses force-balanced, fused-quartz Bourdon tube technology to provide the precise measurement of pressure. During normal operation, the Calibrator performs in either Measure mode or Control mode.

In Control mode, the Calibrator simultaneously measures and controls pressure. Control mode is commonly used in the calibration and testing of pressure gauges, transducers, pressure switches, and production pressure instruments.

In Measure mode, the Calibrator measures pressure. Typically, Measure mode applications are found in research laboratories, wind tunnel testing, power plant testing, and bubbler tank volume accountancy systems. It is also used to monitor barometric pressures, vacuum systems, and differential pressure devices.

Features

The following features are available on all RUSKA 7250 Calibrators.

Fused-Quartz Bourdon Tube Technology

Featuring 1 - 2500 psi full scale ranges. RUSKA's force-balanced, fused-quartz Bourdon tube sensor makes use of the stability, high elasticity, low hysteresis, and excellent fatigue strength of fused quartz. This time-proven technology eliminates the need for gear trains, bearings, shafts, and other moving parts that can wear out or introduce hysteresis or deadband into the process.

Mercury-Free

All components in the Calibrator are mercury-free.

NIST Traceability

All Calibrators are calibrated per ANSI/NCSL Z-540-1-1994 using RUSKA deadweight gauges that are directly traceable to the National Institute of Standards and Technology (NIST) and are provided with NVLAP accredited calibration certificates.

Universal Power Supply

The Calibrators's universal power supply accepts AC voltages between 100 - 240 VAC. To "reconfigure" the Calibrator for use in another country, the user simply changes the power cord.

Measure While Control

The Calibrator simultaneously digitally displays the commanded pressure, the actual pressure, and the difference between the two. A bar graph indicates how close the actual pressure is to the commanded pressure, as well as how close the commanded pressure is to the Calibrator's full scale pressure.

Friendly Display

The Calibrator's color active matrix TFT display combines a bright, low-glare readout with a wide viewing angle. During normal operation, the measured pressure is easily visible from a distance of 10 feet (3 meters).

Adjustable Pressure Display

The pressure display may be adjusted to show one decimal greater than or less than the default resolution.

Ease of Operation

An intuitive, menu-driven interface makes the Calibrator easy to use. Frequently used selections such as the units of measure are restored to memory each time the Calibrator powers up.

Modular Design

The sensing element, pneumatics, electronics, and user interface are separated into modules, making maintenance faster and easier.

Attractive Desktop Packaging

A sturdy aluminum case houses all of the Calibrator's pneumatics, electronics, and user controls. With the optional rack mount kit, this standard 19" EIA chassis fits easily into a rack mount system.

Power-On Self Test

Upon power-up, the Calibrator quickly tests its hardware and software. After the Calibrator completes this test, the user can select more extensive self-tests for the pneumatics and electronics.

Ease of Calibration

Calibration may be performed either remotely or entirely from the front panel. No disassembly is required, and there are no potentiometers to tune. On single sensor units, only a three-point calibration is required to fully characterize the instrument. On instruments that integrate multiple ranges such as the 7250i and 7250xi, additional calibration points are required.

Automatic Zero Adjust

At the user's request, the Calibrator's software automatically performs the zero adjustment, with no potentiometers to tune.

Automatic Head Correction

The Calibrator automatically corrects for head pressure between the Calibrator and the device under test (DUT), taking into account the density of the test gas; e.g., air or nitrogen.

Choice of Medium

Although the Calibrator is not sensitive to the type of gas used within the system, the user can select either instrumentation air or nitrogen, allowing the Calibrator to automatically make pressure head corrections.

Choice of Display Units

Standard units include inHg at 0 °C and 60 °F, kiloPascals, bars, psi, inH2O at 4 °C, 20 °C, and 25 °C, kilograms per square centimeter, mmHg, cmHg at 0 °C, and cmH2O at 4 °C. Altitude and airspeed units include feet, meters, knots, and kilometers per hour. In addition to these predefined units, four user-defined units are programmable.

Communications Interface

The RUSKA 7250 includes standard RS-232 serial and IEEE-488 interfaces. The user’s computer communicates with the Calibrator through the Standard Commands for Programmable Instruments (SCPI) protocol. The RUSKA 7250 shares the same protocol as the RUSKA 7010, 7215, 7215i and 7215xi, therefore, it can operate from software written for any of these products. *The RUSKA 7250 can also be configured to accept existing software written for the RUSKA Series 6000 Digital Pressure Gauge/Controller or the Druck model 510.*

Standard Equipment and Options

A standard RUSKA 7250 includes this manual and a power cord. Although the standard RUSKA 7250 is fully functional with just these items and the appropriate pressure and vacuum supplies, the following options are also available.

Rack Mount Kit: This 6.969" kit meets ANSI/EIA requirements for a 4U, 19" rack mount kit.

Additional Power Cords: Additional power cords are available for most countries.

All options are summarized in Table 1-2 to order these items, please contact Fluke.

Table 1-2. RUSKA 7250 Options List

Option	Part Number
LabView Driver (National Instruments)	Downloadable from World Wide Web
Rack Mount Kit - Cabinets 18-24 inches (45.7 - 61.0 cm) deep	3879677
Vacuum Pump 115/230 VAC 50/60 Hz	3917819
Power Cord - USA, Canada	284174
Power Cord - Central Europe	769422
Power Cord - India, Japan	782771, 3898323
Power Cord - Australia/New Zealand	658641

Chapter 2 Theory of Operation

Introduction

The Calibrator's power supply, electronics, pneumatics, and sensor combine to form a complete, stand-alone, measure and control instrument. This Chapter of the manual describes the Calibrator's component modules and provides a general discussion of each.

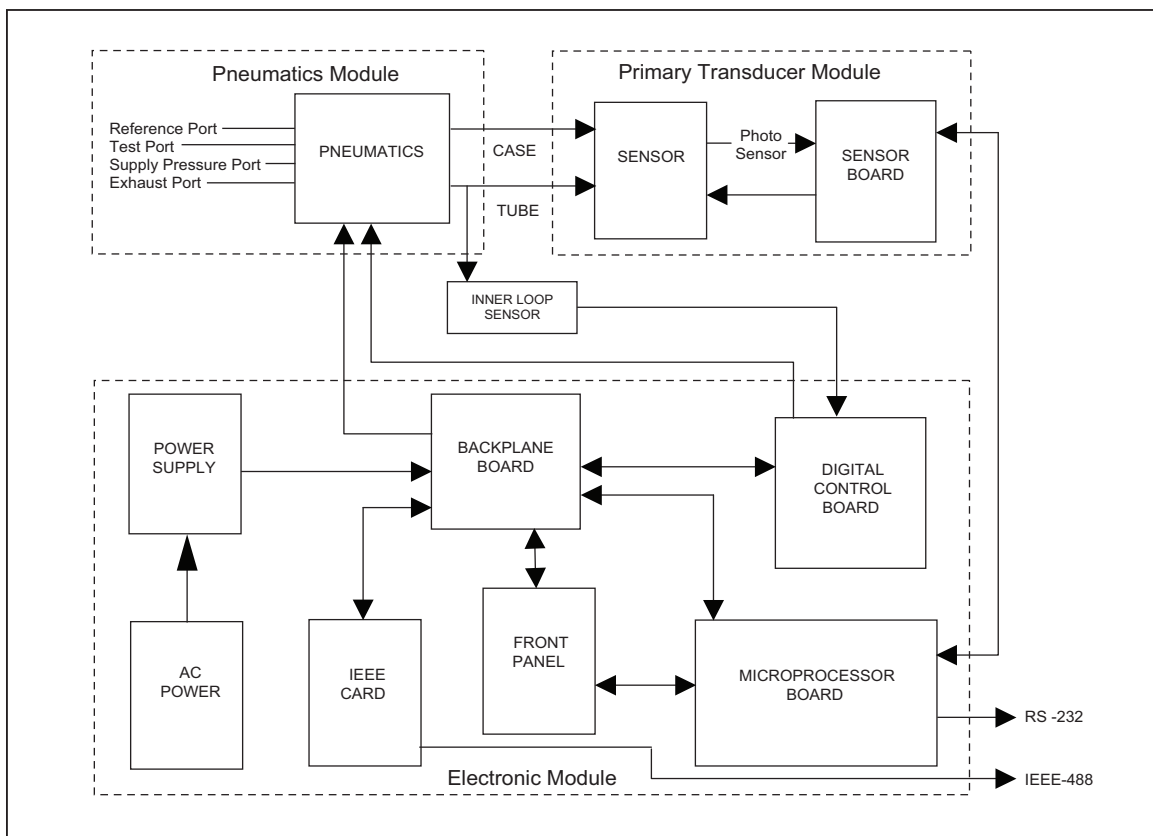

Figure 2-1. Calibrator Block Diagram

gkn002.eps

Power Supply

The Calibrator's universal power supply accepts AC voltages from 100-120 / 220-240 VAC at 50/60 Hz, single phase. This quad-output supply produces +5 VDC, +/-12 VDC, and 24 VDC which are distributed to the Control and Backplane Boards.

Electronics Module

Back-Plane Board

The Back-plane Board is used to interconnect all of the plug-in electronic boards and distribute power. The Microprocessor Board, the Digital Control Board, and the IEEE-488 Interface all plug into the Back-plane Board. The Front Panel communicates with the Microprocessor Board via cables. The Sensor Board communicates with the Microprocessor board through an internal RS-485 serial communication bus.

Microprocessor Board

All of the Calibrator's software resides in nonvolatile, programmable, read-only memory (Flash EPROM) on the Microprocessor Board, which plugs directly into the Back-plane Board. This software contains all of the instructions that operate the Calibrator, as well as the conversion factors that the Calibrator uses to translate the internal pressure unit-of-measure of kPa into the units selected by the user. These factors are given in Table 2-1.

Data that is subject to change after the Calibrator leaves the factory are held in electrically erasable, programmable, read-only memory (EEPROM). This includes the current units of measure, the coefficients from the zeroing process, the current pressure medium, calibration coefficients, and the conversion factors for the four user-defined units of measure.

When the Calibrator powers up, its software is loaded into random access memory (RAM), also on the Microprocessor Board. At the same time, the values stored in EEPROM Board are restored to memory.

Another important component on the Microprocessor Board is the lithium battery. The battery continuously updates the Calibrator's date and time, even when the unit is powered down. This battery has a varying life. If the instrument is left on 24 hours a day, it may last 5 to 10 years. If the instrument is stored, it may only last one year.

The Microprocessor Board also supports the RS-232 serial interface that allows the user's computer to communicate with the Calibrator.

Table 2-1. Conversion Factors

Symbol	Description	Conversion Factor
InHg	inches of mercury (0 °C)	= kPa x 0.2952998
InHg	inches of mercury (60 °F)	= kPa x 0.296134
KPa	KiloPascals	= kPa x 1.0
Bar	Bars	= kPa x 0.01
Psi	pounds per square inch	= kPa x 0.1450377
cmH ₂ O	Centimeters of water (4 °C)	= kPa x 10.19744
inH ₂ O 4 °C	inches of water (4 °C)	= kPa x 4.014742
inH ₂ O 20 °C	inches of water (20 °C)	= kPa x 4.021845
inH ₂ O 25 °C	inches of water (25 °C)	= kPa x 4.024108
kg/cm ²	kilograms per square centimeter	= kPa x 0.0101972
mmHg	Millimeters of mercury (0 °C)	= kPa x 7.500605
cmHg	Centimeters of mercury (0 °C)	= kPa x 0.7500605
knots	indicated airspeed	per NASA TN D-822
km/hr	kilometers per hour	= knots x 1.852
Feet	feet of altitude	per MIL-STD-859A
meters	meters of altitude	per MIL-STD-859A
User1	user defined	= kPa x user defined
User2	user defined	= kPa x user defined
Pa	user defined (Pascals)	= kPa x 1000.0
hPa	user defined (hectoPascals)	= kPa x 10.0
%FS	percent of full scale	

Digital Control Board

The Digital Control Board plugs directly into the Back-plane Board. This board reads a high speed silicon strain gauge pressure transducer, PDCR, connected to the pressure generation point. A digital controller on the board drives two solenoids in the pneumatics section to form a high speed, closed loop controller and control the test and reference solenoids when zeroing.

IEEE-488 Interface

The Calibrator's IEEE-488 (GPIB) interface card, which plugs directly into the Back-plane Board, provides the Calibrator with an IEEE-488 interface. This interface allows the user to automate the measurement and control processes.

Front Panel

The Front Panel contains the active matrix TFT color display, rotary knob and rubberized keys used to operate the Calibrator.

Pneumatics Module

The Calibrator's Pneumatics Module varies depending on whether the Calibrator is a Gauge mode, Absolute mode, or a Simulated Absolute mode instrument. Gauge mode Calibrator's reference their measurements to atmospheric pressure, whereas Absolute mode Calibrator measurements are made with respect to sealed vacuum. A Simulated Absolute mode Calibrator has a barometric sensor in addition to a gauge Bourdon tube sensor. The Calibrator adds the barometric reading to the Bourdon tube reading to obtain a Simulated Absolute value. It can operate as a Gauge mode instrument if the user selects not to add the reference pressure.

The valves, filters, and transducers that make up the pneumatics module of a Gauge mode (or Simulated Absolute) RUSKA 7250 are shown in Figure 2-2. The schematics for the Absolute mode RUSKA 7250s are shown in Figures 2-3 and 2-4.

In the sections that follow, the Zero, Isolation, Apply and Release valves are all 24-volt, DC solenoid valves that are either open or closed depending on the Calibrator's operational mode. Their behavior is summarized in Table 2-2.

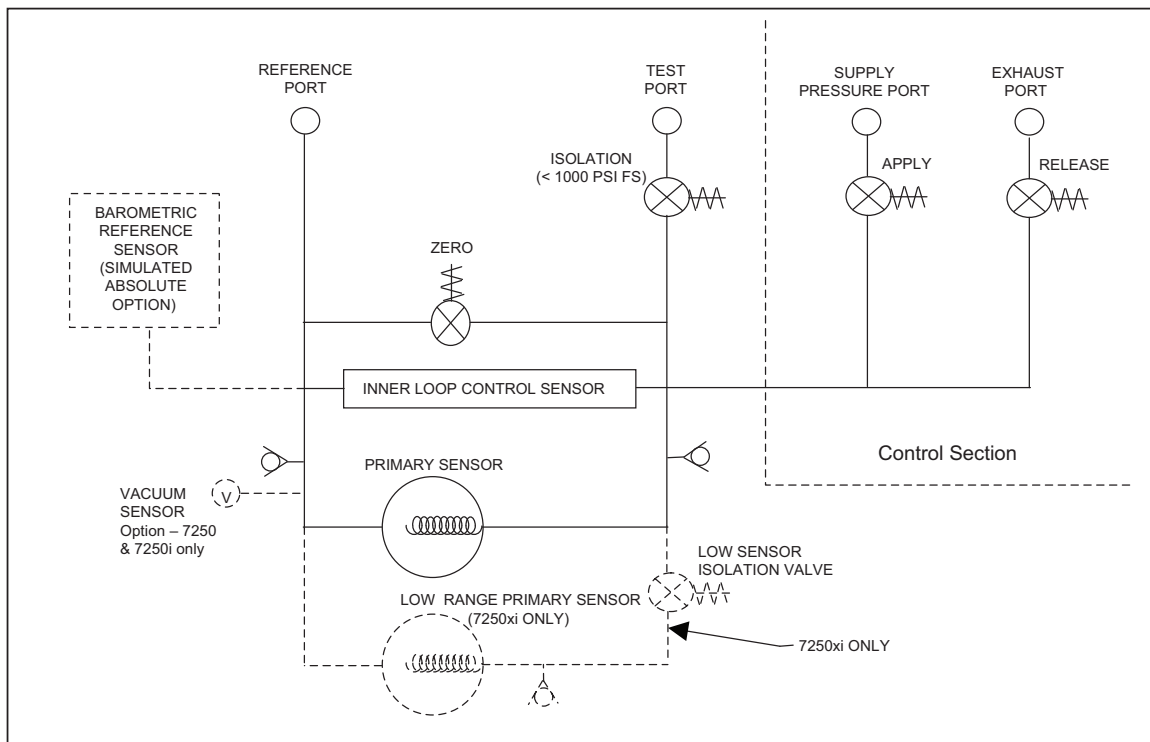

gkn003.eps

**Figure 2-2. RUSKA 7250 Gauge Pneumatics Diagram
5 to 2500 psig (34 kPa - 17.2 MPa) Full Scale Ranges**

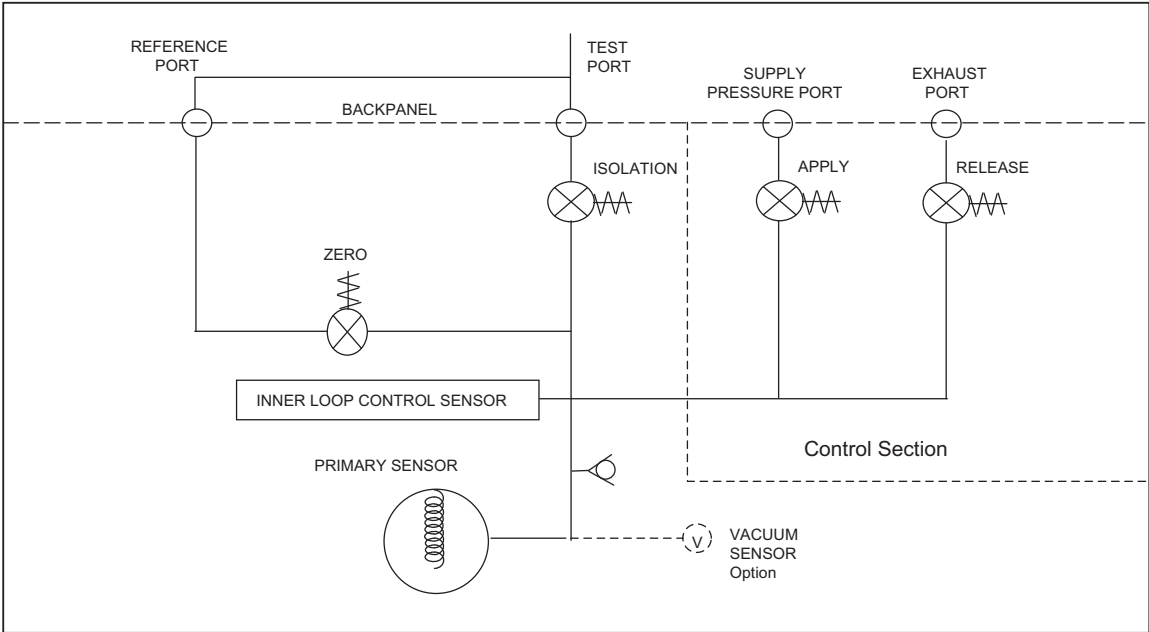

Figure 2-3. RUSKA 7250 Absolute Pneumatics Diagram to 50 PSIA (340 kPa) FS

gkn004.eps

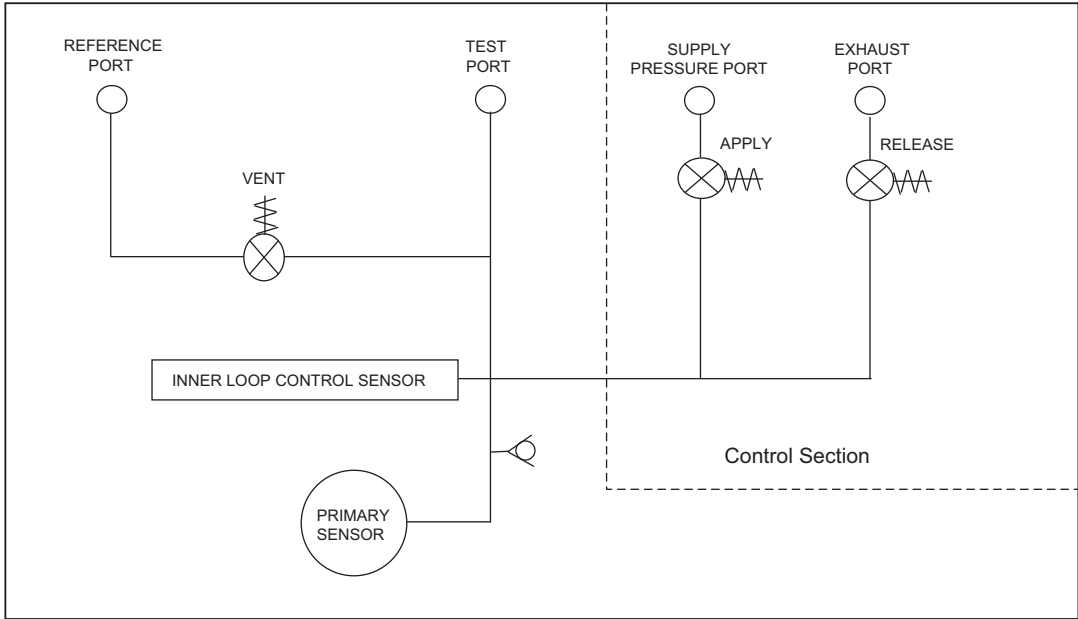

Figure 2-4. RUSKA 7250 Absolute Pneumatics Diagram 3000 PSIA (20.7 MPa) FS

gkn005.eps

Table 2-2. Solenoid Valves States

Valve	Measure Mode	Vent	Control Mode	Zeroing
Test Port Isolation	open	open	open	close
Zero	close	close - open	close	open
Apply	close	close	modulate	close
Release	close	open - close	modulate	close

Measure Mode Pneumatics

Figures 2-2, 2-3 and 2-4 summarize the Pneumatics of the RUSKA 7250.

Reference Port

For gauge measurements, the Reference Port is left open to atmosphere.

The Reference Port is isolated from the Test Port by a solenoid valve that is closed during the Calibrator's Measure and Control modes. When the user commands the Calibrator to perform the zeroing process, the solenoid automatically opens, and the pressures on the Reference Port and Test Port become equal. On permanent absolute instruments, it is recommended to tie the reference port to the exhaust port and then connect them to the vacuum pump. Therefore, when the unit is zeroed, the reference port valve opens, and a vacuum is pulled onto the test port allowing the instrument to zero at a low vacuum level.

The Reference Port is protected by a relief valve.

Barometric Sensor—Optional

For all Simulated Absolute instruments, the Reference Port is monitored by a precision barometric sensor. This sensor provides the barometric offset that allows the Gauge mode Calibrator to function in a simulated Absolute system.

A RUSKA 7250 must have a minimum full scale pressure range of 14.7 psig (101 kPa) in order to be configured to operate in the simulated absolute mode using the barometric reference sensor.

Absolute with Evacuated Reference—Optional for 7250 & 7250i only

An option is available on the RUSKA 7250 that will allow a gauge mode instrument to operate in the absolute mode by evacuating the sensors reference port with an external high capacity vacuum pump. This option includes a vacuum sensor that is internally tied to the reference port of the pressure channel that is configured with this option. In gauge mode, the reference port is open to atmosphere. In the absolute mode, a vacuum pump evacuates the reference port of the sensor. Once a vacuum level of less than 200 mtorr is achieved, the operator can zero the Calibrator. The Calibrator would zero the RUSKA quartz sensor against an internal vacuum sensor measuring this residual vacuum level. This vacuum sensor continuously monitors and updates the pressure reading based on the reference vacuum level.

Following the absolute zero, the channel would operate in the absolute mode. If the Calibrator requires control of sub-atmospheric pressures, then a second vacuum pump should be connected to the exhaust port for use in pressure control. It is not recommended to use one pump connected to both the reference and the exhaust when operating in absolute mode since the controller could cause an unstable reference vacuum.

Test Port

The Test Port connects the DUT to the Pneumatics Module. On systems with a full scale pressure range less than or equal to 1000 psi (7 MPa), the Test Port is isolated from the DUT by a normally closed solenoid valve that is open during the RUSKA 7250's Measure, Control and Vent modes and closed during the zeroing process. This test port isolation valve is not utilized in higher pressure range RUSKA 7250s.

The Test Port is protected by a relief valve.

Vent Procedure

The vent mode is implemented with a fast multi-step procedure. For gauge instruments, the Calibrator controls pressure at the maximum rate towards zero psig. When the primary sensor reads that the pressure is within 1% FS pressure of zero psig, the controller is turned off and the reference zeroing solenoid is opened, which vents the remaining test port pressure to atmosphere. If the Calibrator is at a sub-atmospheric pressure, then the system will control to zero psig, at maximum rate, turn off the controller, and open the zeroing solenoid.

Permanent absolute instruments do not have a valve that allows the test port to be vented to atmosphere. Therefore, these units will control the test port pressure to a value near atmosphere in the setting in the Menu | Setup | Limits screen and then turns off the controller. This allows the operator to safely disconnect the device under test from the test port. However, the instrument is not physically vented to the atmosphere; therefore, the unit would not be measuring atmospheric pressure following a vent.

Control Mode Pneumatics

Pressure Supply Port

The Pressure Supply Port connects the user's regulated gas supply to the Pneumatics Module. Refer to Appendix A for gas specifications and supply pressure limits.

Vacuum Supply (Exhaust) Port

For many applications, a vacuum pump is not necessary.

The Exhaust Port includes a solenoid valve that is open only when the Calibrator is controlling pressure.

In Gauge mode, if the Calibrator will not be used to control pressures at or very near atmospheric pressure, then the Exhaust Port should simply be left open to atmosphere. Likewise, in Absolute mode, if the Calibrator will not be used to control pressures at or below atmospheric pressure, the same rule would apply. However, if the Calibrator will be required to control to atmosphere in Gauge mode or sub-atmospheric pressures in Absolute mode, then a vacuum pump must be connected to the Exhaust Port. Select a vacuum pump with the test port volumes and system slew rates in consideration. The minimum requirements are noted in Appendix A.

Pressure Control

Pressure control is performed by a dual-loop control system. The inner loop is a digital loop using a high frequency response silicon strain gauge sensor, a digital controller, and two pulse-width modulated solenoids. The two solenoids either add gas to the test port or remove it. The outer loop provides closed-loop control, based on feedback from the quartz Bourdon tube and an analog output setting which provides the desired set-point for the inner loop.

Control Strategy

Inner vs. Outer Loops

The inner loop accepts a signal from the outer loop and uses this signal as the pressure set-point. The inner loop uses a high frequency response strain gauge sensor as its reference. The frequency response of this transducer allows for high speed modulation of the solenoids. This sensor is aligned to the high accuracy quartz sensor when the system is Auto-tuned.

The outer loop is a lower frequency response, analog-digital loop. The outer loop uses a calibrated, forced-balanced sensor. This sensor is used to monitor the pressure of the system. The results are used for the displayed pressure. The outer loop is responsible for adjusting the signal sent to the inner loop to compensate for temperature and time drifts associated with the inner loop sensor.

Normal Mode

In the Normal mode, minimizing pressure overshooting takes precedence over control speed. In the Fast Mode, control speed takes precedence over overshooting the set-point.

In the Normal mode, the inner loop controls to the set-point using maximum rate until close to set-point and then slowing down as the set-point is approached to minimize overshoot. The outer loop continually adjusts the inner loop to compensate for temperature and drift.

Fast Mode

This mode of operation assumes that the inner loop sensor and the outer loop are aligned. When a new set-point is issued, the outer loop sends a signal that was determined to be equivalent to the desired pressure. When the system detects that the pressure is sufficiently close to the desired set-point, then the outer loop switches to the PID algorithm.

This control mode results in the highest speed pressure control.

Alignment of Inner Loop with Outer Loop

Since the control system of the Calibrator is based on the alignment between the inner and outer loop sensors, there is a procedure that automatically aligns these sensors. It is possible that during typical operation the alignment between the inner loop and the outer loop sensor can become miss-aligned. This can cause control problems such as overshoot. This can be realigned using the Auto-Tune feature. See Chapter 6, Maintenance, for details on the Auto-Tune functions of the RUSKA 7250.

PID Control

The outer loop pressure controller is a form of PID control executed every 100 milliseconds (10 times per second). The pressure is controlled to an exponential decay curve.

$$V = p * (S - A) + i * \int (S - A) dt + d * \frac{d}{dt} (S - A)$$

S = Set-point

A = Actual

V = Control Output

p, i, d = Control Coefficients

Figure 2-5 shows typical Control mode operation. Pressure in percent of full scale is plotted versus time to show the change in pressure as the instrument steps from one control point to the next.

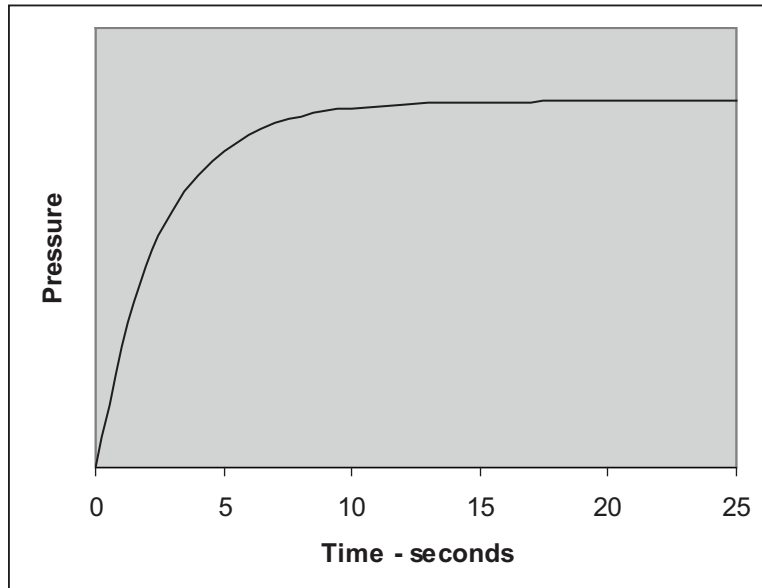

Figure 2-5. Pressure Control

gkn054.eps

Transducer Module

Quartz Bourdon Tube Sensor (Transducer01)

The quartz Bourdon tube sensor is mounted in a machined aluminum housing. The sensor consists of a helical quartz tube with a mirror affixed to one end, as shown in Figure 2-6.

A rigid beam is attached transverse to the axis of the helical tube. Attached to both ends of this beam are electromagnetic coils. Mounted beneath the coils are permanent magnets. A lamp assembly directs light through a quartz or sapphire window onto the mirror affixed to the helical tube, as shown in Figure 2-7.

The mirror reflects the light back through the window and strikes two matching photodiodes. When there is zero pressure differential across the helical tube, the photodiode assembly is mechanically adjusted so that the light spot is centered between each photocell. In this “zero position,” the outputs of the two photodiodes provide energy used to maintain the quartz assembly in its zero position; thus, a force balance is created.

As pressure is applied in the helical tube, the entire apparatus attempts to rotate. This causes the mirror to move the reflected light spot to shine more on one photodiode than the other. The Sensor Board (see the next section in this Chapter, Sensor Board) then responds by changing the current to the electromagnetic coils that, through interaction with the permanent magnets, force the helical tube to return to its zero position. The amount of current required to do this is proportional to the pressure applied across the helical tube. Thus, the pressure is determined by the amount of current required to return the helical tube to its zero position.



On Absolute Models, the process is similar, except that the Bourdon tube is permanently evacuated to less than 0.1 mtorr and sealed at the factory, and the test pressure is applied to the sensor case. With this configuration, all test pressures are measured with respect to vacuum.

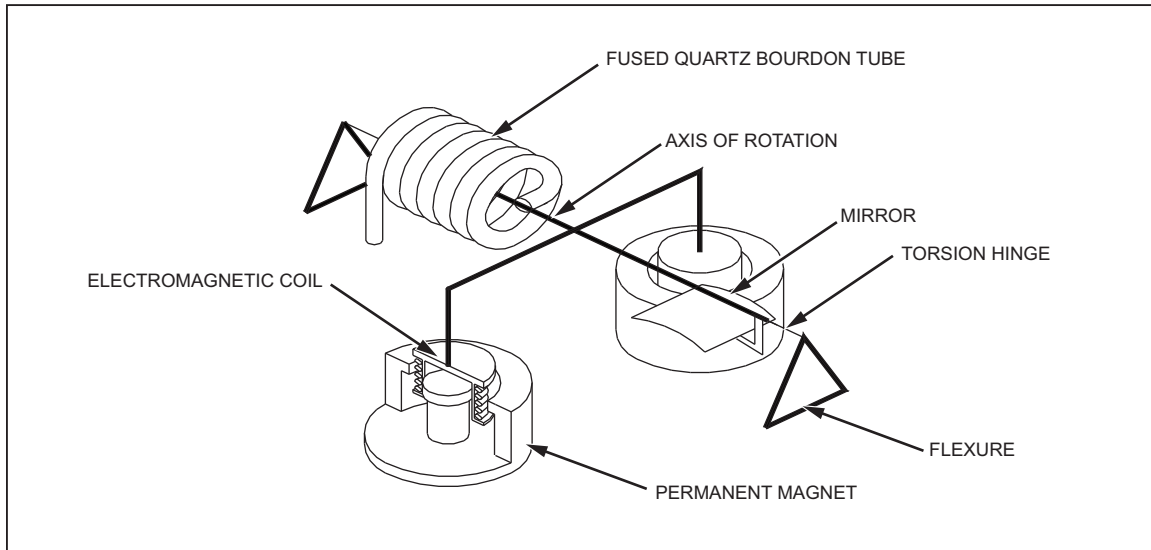

Figure 2-6. Shaft/Magnet Section

gkn008.eps

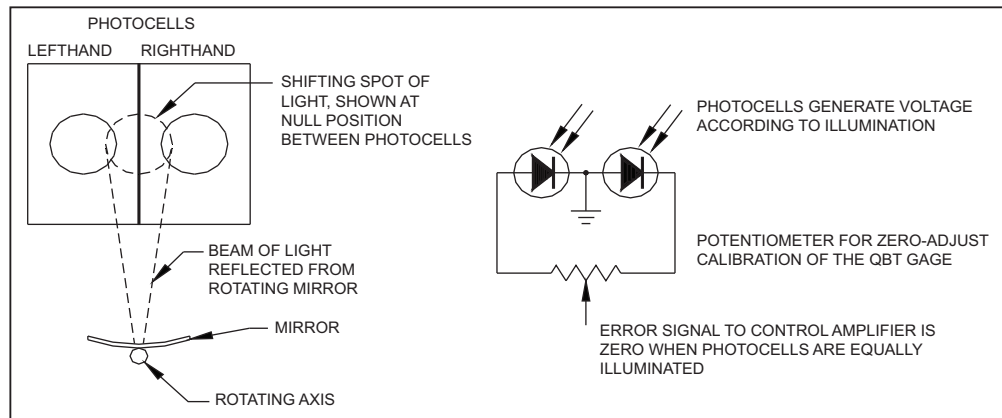

Figure 2-7. Photocell/Light Spot

gkn009.eps

Sensor Board

A temperature sensor, the quartz Bourdon tube pressure sensor and vacuum sensor are monitored by the Sensor Board. The Sensor board is also used to control and maintain the sensor housing at 50 °C.

Linearization Term

As described in the previous section, the relationship between the pressure being measured and the current required to keep the quartz Bourdon tube in its zero position is the main principle behind the operation of the Calibrator's sensing element.

Ideally this pressure-current relationship would be a linear equation of the form

$$I = kP,$$

where I is current, k is a constant of proportionality, and P is pressure. However, due to certain mechanical characteristics of the helical tube and its supporting structure, this pressure-current relationship is slightly nonlinear. The nonlinear portion of this pressure-current relationship closely follows the form of a second order polynomial, or

$$I = aP^2 + bP + c$$

where again P is pressure and a, b, and c are coefficients generated during the calibration procedure as discussed below.

When the user performs a three-point calibration, RUSKA 7250's software creates the three coefficients based on the user's zero, mid-point, and full-scale adjustments. From then on, the nonlinear term given above is subtracted from the total pressure-current curve to achieve the desired linear pressure-current relationship.

On the RUSKA 7250i and 7250xi, multiple quartz sensor ranges are used in order to provide the percent of reading specification. In these instruments, a total of three points per range with one point shared between two ranges is required. Therefore, for the RUSKA 7250i, a 5 point calibration is performed and for the RUSKA 7250xi, a 9 point calibration is performed to fully characterize the RUSKA quartz sensors.

Auxiliary Sensors

Auxiliary sensors are sensors such as the oven temperature sensor. These are reference sensors aligned at the factory and are utilized by the firmware.

Case Reference Vacuum Sensor

The case reference vacuum sensor is a user installed option. See Chapter 3, Pneumatic Connections; Vacuum Sensor - Option. The user needs this sensor to zero an Absolute Calibrator. Please note that the uncertainty of the vacuum sensor used to zero the RUSKA 7250 must be considered in the overall uncertainty analysis of the Calibrator.

Software

The RUSKA 7250 is a digital, software-based instrument. The controlling software uses a PID algorithm and allows for user-definable units and onboard programming. The software control loop is a digital outer loop with a high speed inner loop.

Software Safety Controls

Preventing Operator Errors

The operator is required to verify a change to Control mode or Vent mode by pressing the Enter key. Additionally, the control set-point is set to zero on power-up or when any of the limit errors occur.

Pneumatic Errors

The Calibrator continually monitors the pressure for low, high, and slew (rate of change) limits. When these limits are exceeded, the Calibrator is returned to Measure mode, shuts off the apply and exhaust control valves, and an error message is generated. Additionally a vent limit may be set. The Calibrator will go to Vent mode when the pressure exceeds this limit.

Shut Offs

Measure mode can be entered at any time by pressing the Measure key on the main keypad with no further acknowledgment required. The Calibrator will turn off the controller.

Oven Control

The oven temperature is controlled via a pulse-width modulated signal. The time the heater is on can be varied from 0 to 100%. The pulse-width at startup is initialized to the previous value, which was stored in the battery-backed CMOS RAM.

The oven control is a PID controller updated approximately every 7 seconds. The sensor readings are accessed by pressing Menu | Display. With an exception of the 3000 psi (20.7 MPa) version RUSKA 7250, the high accuracy quartz sensor is housed in a temperature controlled oven. There is a 3 hour warm-up time required prior to the Calibrator operating at its optimum precision. The user can verify when the instrument is

thermally stable by viewing the Menu | Display screen and verifying that the temperature is at 50 °C. In addition to the temperature, this screen will show the duty cycle of the oven.

When operating the system in either a very cold or hot environment, if the oven is unable to maintain the temperature of the internal oven, the Calibrator will generate an Oven Control Failure error messages. The operator can review the temperature and duty cycle of the oven by pressing the Menu | Display keys. The unit must have been warmed up for a minimum of 3 hours prior to determining the condition of the oven temperature control. The temperature of the sensor should be controlled to 50 °C. The Duty Cycle indicates the amount of time (in units of percentage) that the oven control is turned on in order to maintain the oven at the proper set-point of 50 °C. A unit that is operating properly, after it has fully warmed up, should indicate a sensor temperature of 50 °C and a duty cycle between 10 to 90%.

If operating the instrument in a very cold environment and the oven duty cycle is at a high percentage (>90%) you will need to turn the fan off. If you are operating in a warm environment or when multiple systems are housed in consoles without adequate ventilation, the system may become too hot and generate the Oven Control Failure error message. If operating the instrument in a warm environment and the oven duty cycle is at a low percentage (>10%) you will need to turn the fan on. See Chapter 6, Fan Operation.

When the operator changes the status of the fan, it will remain in that condition until the operator changes the setting.

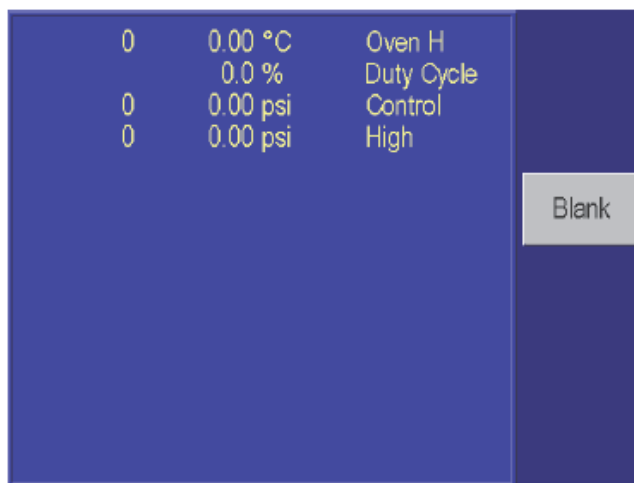

Figure 2-8. Menu | Display - Menu

gkn012.bmp

Pressure Reading and Correction

The sensor's analog output is processed by an analog-to-digital circuit that results in an output referred to as counts. This output is corrected for the applied effects listed below.

The counts are linearized and the resulting pressure value is corrected for the variations in head pressure, vacuum, case effect, and oven temperature effects.

The following equations are used by the control algorithm to adjust and correct the pressure signal.

Zero Coefficients

CsH Zero correction for High FSR (Full-Scale Resistors) Value is in counts (7,381,975 = full scale of current sensor).

CsL Zero correction for Low FSR. Value is in counts (7,381,975 = full scale of low FSR)

- HsZ Hardware zero correction. (0 to 4095, center is 2048).
- SsZ Zero corrections scaling factor. Ratio of High FSR to Low FSR. Used only when Case Effect Coefficient or Oven Temperature Coefficient are non-zero.

s=0 for high range sensor, s=1 for low range sensor.

Range Coefficients

- KnF 0=Range Unused
4=Valid High FSR Range
5=Valid Low FSR Range
- Kn0, Kn1, Kn2 Calibration constants for range

$$B = \frac{K_{n2}}{2^{48}} * A^2 + \frac{K_{n1}}{2^{24}} * A + K_{n0}$$

Where A is the zero corrected counts (7,381,975 = full scale of current range) and B is the calibrated counts (7,381,975 = full scale of current sensor)

- KnH Zero corrected counts for upper limit of range. When the zero corrected counts from the A/D exceed this value the next higher range will be used (if possible). (7,381,975 = full scale of current range)
- KnL Zero corrected counts for lower limit of range. When the zero corrected counts from the A/D are below this value the next lower range will be used (if possible). (7,381,975 = full scale of current range)
- n=Range number (1 - 4 for high range sensor, 5 - 8 for low range sensor)

Chapter 3

Installation

Introduction

This section of the manual discusses initial installation for the RUSKA 7250. Installing the Calibrator involves connecting the supply and test pressure tubing, powering up the unit, and configuring the system through the front panel.

⚠⚠ Warning

To prevent possible electrical shock, fire, or personal injury:

- **Connect an approved three-conductor mains power cord to a grounded power outlet.**
- **Make sure that the Product is grounded before use.**
- **Do not put the Product where access to the mains power cord is blocked.**
- **Do not use an extension cord or adapter plug.**

Unpacking the Calibrator

Carefully unpack all components, checking for obvious signs of damage. The shipment contains the following items:

- RUSKA 7250, 7250i, 7250xi or 7250LP,
- power cord,
- user's manual,
- calibration report,
- user-specified instrument options.

If necessary, report any shipping damage to the freight agency. Remove all shipping and packing materials (including the shipping plugs) from all components. If possible, save the packing materials for future shipping needs.

Finally, install the RUSKA 7250 in a location that meets the requirements listed in Table 3-1.

Note

The DPC should be handled in such a way as to minimize mechanical shocks or vibration during installation or use. It should be mounted on a rigid bench or in a sturdy 19" rack. Although the zeroing process will compensate for a slightly unlevel mounting, the DPC should be mounted to within 5° of level.

Table 3-1. General Specifications and Parameters

Parameter	Value	Model
Operating Humidity	5–95%RH, noncondensing	all
Storage Humidity	none*	all
Operating Temperature	18 to 36 °C	all
Storage Temperature	-20 to 70 °C	all
Electrical Power	100 – 120/220 – 240 VAC	all
Power Consumption	150 W	all
Warm-up Period	< 3 hrs	all

*If there is any condensation when storing the Calibrator, it must be thoroughly dried before power is applied. It is also recommended to connect the reference port to the test port and evacuating these simultaneously to remove any moisture from the sensor.

Cautions

The following cautions should be heeded at all times to ensure safe operation of the Calibrator.

Warning

Never operate the Calibrator with the cover removed. The power supply has internal voltages near 400 volts.

Never apply more than 120% of the Calibrator's full scale as a pressure supply. Pressure supply must be regulated and meet all criteria as stated in Appendix A of this manual.

Never apply more than 110% of the Calibrator's full scale to the test port. Never try to control while a pressure source is connected to the test port.

Caution

Do not expose the instrument to thermal and mechanical shock, or vibration. This may affect performance and require re-zeroing.

(See Chapter 1, Safety Information.)

Powering Up the Calibrator

First, plug the power cord supplied with the Calibrator into the power connector on the Calibrator's back panel.

Caution

Grounding for the Calibrator is provided through the power cord.

Next, plug the power cord into a receptacle rated between 100 and 240 V ac, 50/60 Hz, single phase. If a different power cord is necessary for your receptacle, consult Table 1-2 for available power cords.

Finally, turn on the Calibrator by toggling the power switch on the back panel. When the Measure screen appears on the display, the front panel will be fully operational.

Observing the Calibrator's Full Scale Rating

To observe the Calibrator's full scale rating,

1. Press Previous until the Main Menu appears.
2. Select Menu | Test | Electrical. The Calibrator's full scale pressure rating (FS) will appear on the screen (in the currently selected units of measure).
3. To return to the Main Menu, press Previous.

Pneumatic Connections

Pneumatic connection to the Calibrator is straightforward. The following sections discuss each port. All ports are 1/4-inch NPT pipe fittings. See Figure 3-1. Remove all plastic shipping plugs from the back panel pneumatic ports.

Pressure Supply Port

The pressure supply port must be connected to a regulated source of clean, dry nitrogen or air. Shop air should not be used. Refer to Appendix A for supply port gas purity and pressure regulation requirements.

Tubing must be of at least 1/8-inch (3 mm) inside diameter and of a sufficient wall thickness for the pressure. Either stainless steel or copper tubing is acceptable.

Exhaust Port

The exhaust port may be left open to atmosphere under most conditions. A vacuum pump is required in Absolute mode for controlling pressure below atmospheric pressure, and will allow lower pressure control in Gauge mode (i.e. to control to 0 psig). Supply vacuum lines must have minimum restrictions. Tubing should have a minimum I.D. of 1/4-inch. In small rooms, the exhaust port should be piped outside to prevent an accumulation of nitrogen. It is also very important to install an auto-vent valve to the vacuum pump. The purpose of the valve is to vent the vacuum to atmosphere when the pump is turned off.

The addition of tubing to direct discharged gas out of the work area will also significantly reduce audible noise. It is acceptable to add tubing to the exhaust port for the primary purpose of reducing noise. Care should be used to prevent blockage of the exhaust tube. If the exhaust tube is significantly restricted, then the exhaust tube can be exposed to full scale pressures.

Absolute Models

When the Calibrator is a permanent absolute system, then the Exhaust port and Reference port can be externally connected together to allow the system to function with a single vacuum pump. Using 1/4-inch NPT fittings, connect tubing with a minimum I.D. of 1/4-inch to the Exhaust port and the Reference port. Using appropriate pneumatic fittings, connect the other end of the tubing to the vacuum supply line(s). This allows the system to function with a single vacuum pump. The system will use the vacuum source for control or zeroing, as required.

Test Port

The device(s) under test is connected to the test port. The Calibrator controller is designed to operate within its specification limits into load volumes from 5 to 60 in³ (80 to 1000 cc). Excessive leaks in the test volume will cause measurement errors in the device under test and may possibly affect control stability. Tubing connected from the test port to the load volume should have an internal diameter greater than 1/8 inches (3 mm). Tubing should be shorter than 15 feet (5 meters) when minimum diameter tubing is used.

Reference Port

The reference port is open to atmosphere for gauge measurements or it can be connected to the Reference Port of the Device Under Test.

Instruments with a low full-scale pressure range require special handling to assure the performance of the instrument. These instruments are very sensitive to atmospheric pressure changes including disturbances in the atmospheric pressure. The reference side must be very carefully controlled or changes due to wind, air handlers, doors shutting, etc. will cause major variations. The Calibrator tracks these changes but it may not track in the same way as the device under test. To control these changes, it is recommended that the reference port of all relevant devices be tied to the reference port of the Calibrator.

The reference port can be sealed from atmosphere in most applications where the test times are relatively short. This isolates the port from pressure changes in the atmosphere and results in very stable pressure measurement and control.

If the test times are relatively long, in addition to connecting the reference ports together, they should also be connected to a tank with a volume of 200 cubic inches or better. The tank should be vented to atmosphere through a small orifice bleeder valve at the other end of the tank. The entire reference assembly should be shielded from rapid fluctuations in air temperature and flow. The vent valve should be set experimentally. In an environment with no temperature change, it would be closed. In an environment with no pressure fluctuations it would be wide open. The heat from the Calibrator oven and control valves will cause some temperature variations. Thus the appropriate setting varies but a good compromise can be found. To observe the variations, connect the reference as discussed and open the test port to the atmosphere. In measure mode, the Calibrator will indicate the variations. A good filter may be usable in place of the valve if it provides approximately the correct restriction of air flow.

One consideration is that if the reference port is completely sealed from atmosphere, its pressure will change due to barometric pressure changes or temperature changes in the environment. If the pressure in the reference port becomes lower than the barometric pressure, then a vacuum pump would need to be attached to the exhaust port to allow the controller to control down close to 0 psig.

For permanently absolute systems, a vacuum pump capable of producing a vacuum level of 100 mTorr or less at the sensor reference port is required (used to zero the sensor). See Appendix A for vacuum pump requirements. (See Chapter 3, Exhaust Ports - Absolute Models).

For instruments that have a barometric reference sensor option, the barometer is tied to the reference port. When operating in the gauge mode, the reference port should be connected as noted above. When operating in the absolute mode, if the ambient pressure is not stable, sealing the reference port from atmosphere will improve the control stability of the Calibrator.

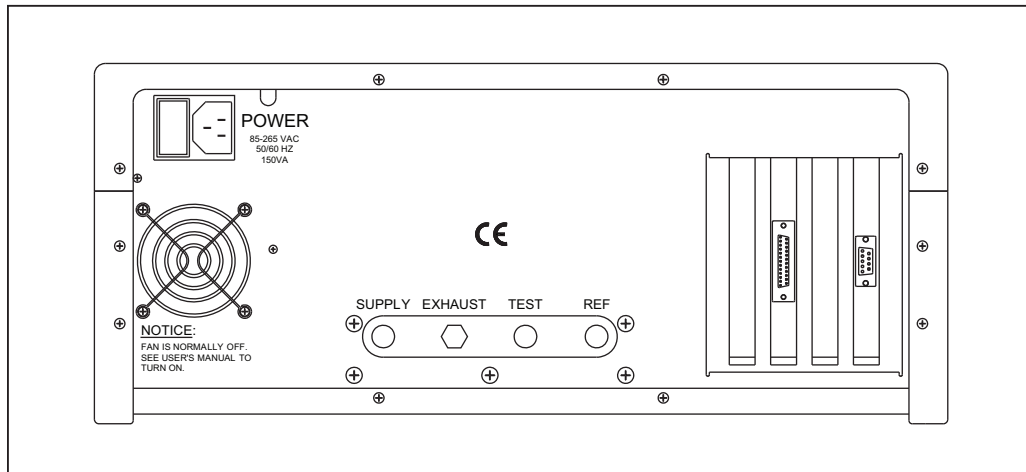

gkn010.eps

Figure 3-1. RUSKA 7250 Back Panel

Vacuum Sensor—Option

The RUSKA 7250 is also available with a vacuum sensor option. On a permanent absolute instrument, this sensor is used to zero the RUSKA quartz sensor at a high vacuum.

On a Calibrator that has the Evacuated Reference Option, this vacuum sensor is used to monitor the vacuum level in the reference port when the reference port is pulled to a hard vacuum allowing the Calibrator to operate in the absolute mode.

Chapter 4

Local Operation

Introduction

This section of the manual describes operation of the RUSKA 7250 using the front panel. The local interface (front panel) consists of a color TFT display, a rotary knob and a set of keys. The display shows the system status and menu options. The keys are grouped according to function.

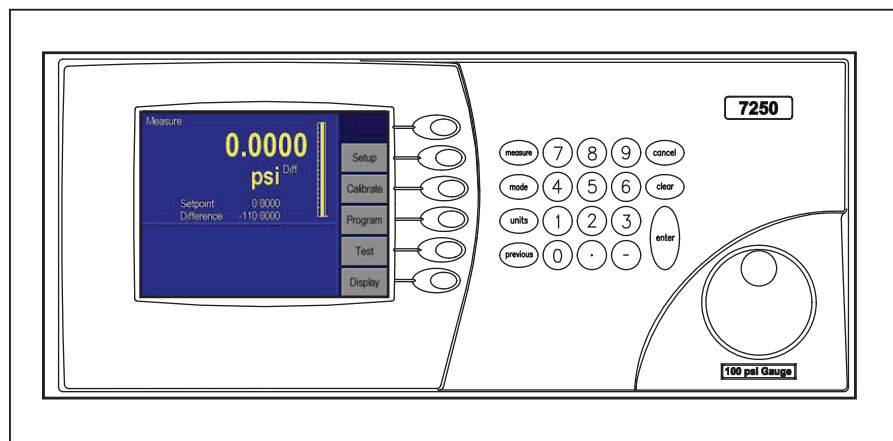

Figure 4-1. RUSKA 7250 Front Panel

gkn011.eps

Numeric Keypad

This includes the number keys, the decimal point [.] , and the change sign key [-]. The UNITS key changes between units of measure, MODE changes between modes of operation such as gauge and absolute, MEASURE is used to place the unit into measure mode. CLEAR key will clear the numeric entry field. The ENTER key accepts the entered number or confirms a command.

Function Keys

These are the six keys that run vertically beside the display. The label shown in the display beside each key identifies their function. These functions will change based on which screen you are operating. For ease of communication, throughout the manual we refer to these keys as [F1] through [F6]. We consider the top key to be [F1] and the bottom [F6].

Rotary Knob

The rotary knob selects a field for editing and is used for small pressure changes (pressure jog) at the main menu.

Cancel, Previous

These keys are used to stop, undo, or exit the current operation. The CANCEL key returns all edited fields on the current entry screen to their original values. It also stops the current program sequence or calibration process. The PREVIOUS key exits the current menu and returns to the previous menu.

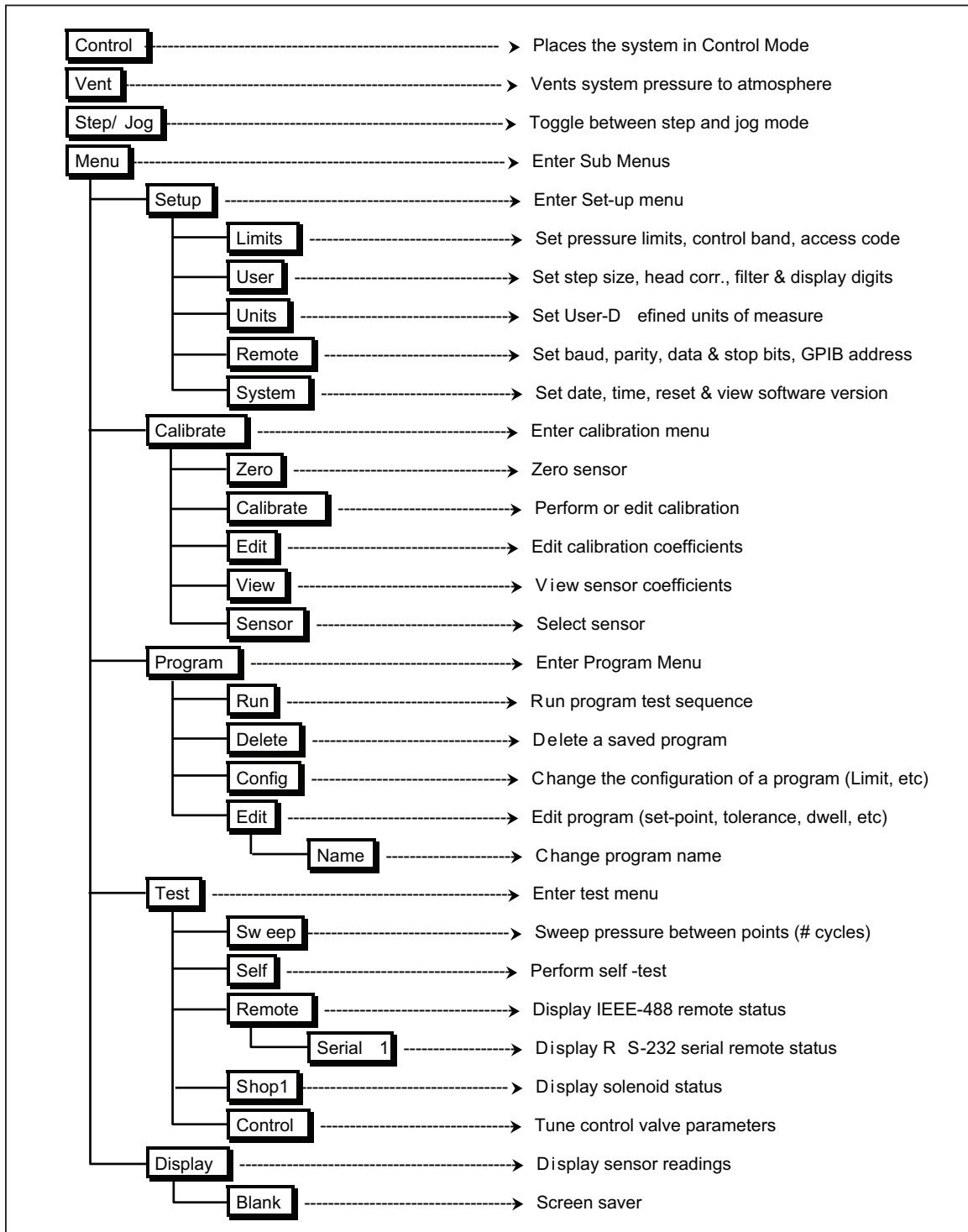

Figure 4-2. Menu Tree

gkn053.eps

Figure 4-2 is a menu tree showing the relationship between all the menus in the system. Refer to it for selections available under the menu. To move to a lower menu, press the function key with the correct label. To move towards the main menu, press the PREVIOUS key. In the Main Menu screen, the [F2] key places the unit in Control mode, ENTER must be pressed to actually enter the Control mode. The [F3] key places the unit in Vent mode. This opens the test port to atmosphere and rapidly reduces the pressure, ENTER is required to confirm the operation. The [F5] key places the unit either the step or the jog mode and the rotary knob is then used to set the control set-point by the correct step or jog amount. To go to one of the menus, press the [F6] key.

Tutorial

To begin the tutorial, first verify that the RUSKA 7250 is powered-up and that the pneumatic connections have been completed. The Calibrator should display a screen similar to the one shown below. (The right hand side of the display should show the options). At power up, there may be errors relating to the default settings. If an error message is displayed in red at the bottom of the screen, press [F6], then press PREVIOUS. If multiple errors exist, you will need to press the [F6] key multiple times to clear all of the errors.



Figure 4-3. Main Menu

gkn014.bmp

Figure 4-3 shows the Main Menu. It is at the top level of the menu tree (see Figure 4-2) and all descriptions in this manual start from this point. The double sized numbers in the top center of the display shows the current measured pressure (0.00 psi diff). The upper left corner shows the current mode of the Calibrator (*Measure*, *Control* or *Vent*). The right side of the screen shows a bar graph displaying the current pressure relative to a user-configurable full-scale value. Below the pressure is the pressure control set-point, below this is the difference between the set-point and the actual value. Below this is a numeric scratchpad for entering a new set-point value. The highlighted label on the right hand side of the screen displays the current assignments of the function keys [F1] through [F6] that are located beside the display.

1. Change the pressure units. The units are changed by selecting the UNITS key on the keypad.

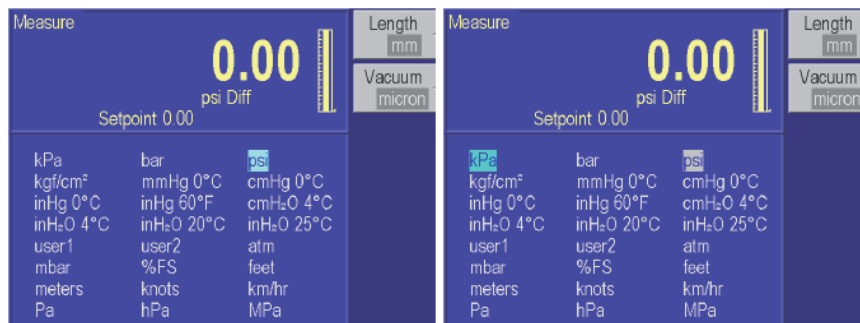

Figure 4-4. Units Menu

gkn015.bmp

- Use the rotary knob located to the right of the display to move the highlight bar to the desired unit.

Note

The highlighted cursor initially shows the current unit of measure. When the rotary knob is moved, the current unit remains highlighted in a gray color, and the new unit is highlighted in a light blue color.

- When the unit desired is highlighted, press the ENTER key on the far right side of the front panel, under the numeric keypad. The display will return to the MAIN screen with the current units.

The second part of this tutorial uses the RUSKA 7250 to generate pressure. The pressure supply must be connected and the test port must be connected to a closed volume, in accordance with Chapter 3, Pneumatic Connections, of this manual.

- From the Main Menu, use the numeric keypad to enter the starting pressure. The pressure is entered in the units set in the previous exercise. As the pressure is entered, each digit will be displayed in the numeric scratchpad (the highlighted box in the lower section of the display). If a mistake is made, press the CLEAR key (found in the numeric keypad), and the numeric scratchpad will be cleared.



Figure 4-5. Entering Pressure in the Main Menu

gkn016.bmp

- When the entry is correct, press the ENTER key. The scratchpad will be cleared and the value will appear as the new set-point.
- Now that the starting pressure is entered, enter Control mode. Press CONTROL [F2]. The CONTROL label will be highlight, and the message “Press Enter to Confirm”

will appear below the scratch pad. Notice that the upper left corner still shows MEASURE. The Calibrator stays in Measure mode until the change is confirmed.

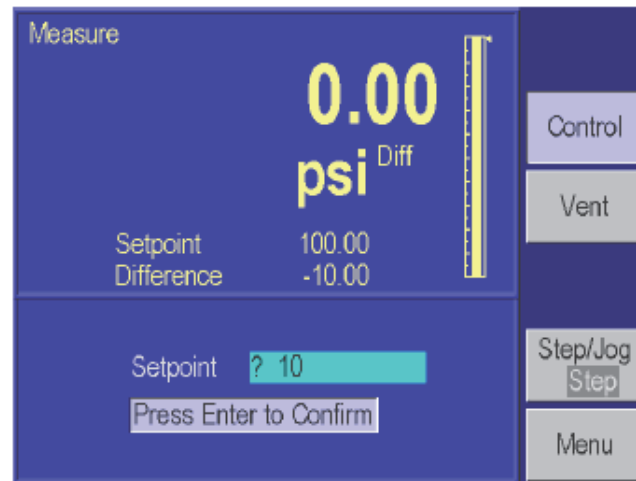

Figure 4-6. Control Mode in Main Menu

gkn017.bmp

7. Press ENTER to confirm the mode change. The upper left corner will change to CONTROL, and the pressure will start moving towards the set-point.
8. After the pressure is stabilized, assure that the word Step is highlighted in the Step/Jog [F5]. The Step/Jog [F5] toggles between Step and Jog, to switch between these modes, press the function key [F5]. In addition to using the key-pad to enter a pressure set-point, you can also use the step function. Using the rotary knob, rotate the knob clock-wise to increase the set-point, or counter clock-wise to decrease the controller set-point. The scratchpad will be updated with a new set-point. The step size defaults to 10% of full scale. This step size is user defined and can be changed in the Menu | Setup | User menu.
9. Press ENTER to accept the new set-point. The Calibrator will move to the new set-point.
10. Press Measure key which is located in the key-pad. The Calibrator will change to Measure mode. No confirmation is necessary to leave Control mode.

Selecting Language

The RUSKA 7250 can operate in a variety of different languages. To select a different language, press the MODE key two times MODE, MODE. The current language will be highlighted. Use the rotary knob to highlight a new language and hit the ENTER key to select that language.

Selecting Mode of Operation

The RUSKA 7250 is offered in four different modes. These are gauge only, permanent absolute only or gauge mode with simulated absolute mode using a barometric reference sensor, or finally gauge/absolute mode by venting or evacuating the reference port of the differential sensor.

Simulated Absolute Instruments

This RUSKA 7250 is a Gauge and Vacuum (Negative Gauge) instrument with a barometric reference sensor. The summation of the pressure reading from the measurement sensor in the Calibrator and the pressure reading from the barometric sensor provides for the "simulated absolute" pressure display. To change mode, from the keypad, press Mode, then select either Absolute [F1] or Gauge [F2] or Tare [F3]. Please note that the available selection may vary from unit to unit. For instance, on a permanent absolute instrument, the "Gauge" option would not be available but the simulated gauge is, via the Tare function.

Absolute with Evacuated Reference—Optional for RUSKA 7250 & 7250i only

The RUSKA 7250 is a gauge mode instrument when the reference port is open to atmosphere. It can also operate in the absolute mode by evacuating the reference port with an external high capacity vacuum pump. A unit configured with this option includes a vacuum sensor that is internally tied to the reference port. When switching from the gauge mode to the absolute mode, a vacuum pump evacuates the reference port of the sensor. Once a vacuum level of less than 100 mtorr is achieved, the operator zero's the Pressure Controller/Calibrator. The Calibrator would zero the RUSKA quartz sensor and then correct the reading to account for the residual vacuum remaining in the reference port as measured by the internal vacuum sensor. This vacuum sensor continuously monitors and updates the pressure reading based on the reference vacuum level. This automatically corrects the Calibrator's measurement as the vacuum level changes in the reference port.

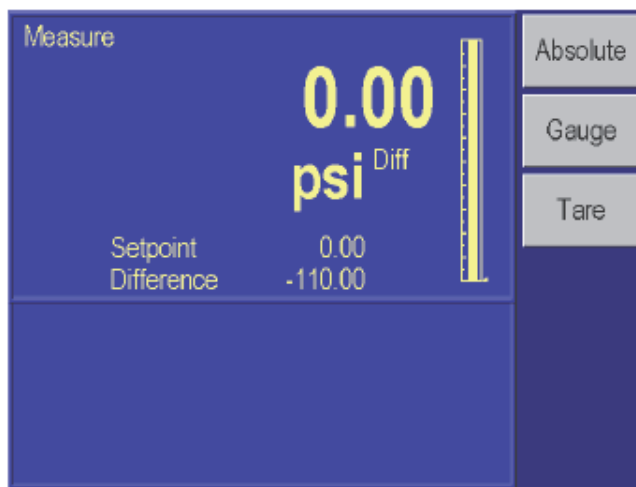

Figure 4-7. Mode Menu

gkn018.bmp

Main Menu

The Main Menu displays the measured pressure in double-sized numbers. Below the pressure reading is the current unit of measure and mode (Gauge, Differential or Absolute). The Main Menu can always be reached by repeatedly pressing PREVIOUS. The RUSKA 7250 is designed such that all of the commonly used functions are accessible by a direct key on the key pad or from a top level function key. Less commonly used set-up type functions are accessible through the menu function key.

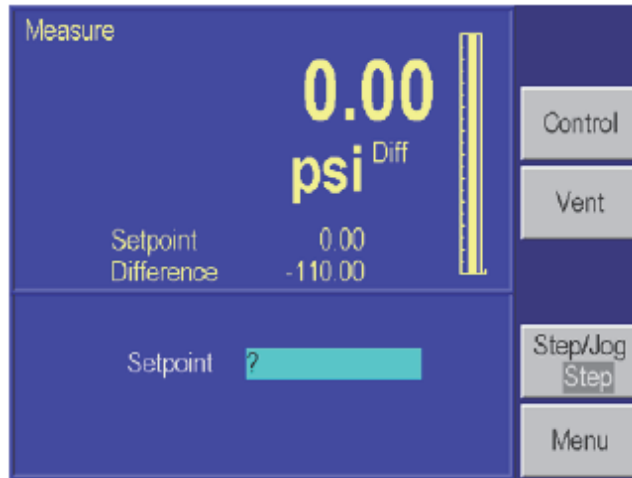

Figure 4-8. Functions in Main Menu

gkn019.bmp

Note

For Calibrators with pressure ranges greater than 100 psi (700 kPa), the supply pressure port must be plugged or connected to a properly set pressure supply in order to measure pressure greater than 100 psi (700 kPa).

Controlling Pressure

The Control [F2] function key is used to place the Calibrator into the Control Mode. A pressure set-point should be entered into the Calibrator prior to placing the unit into the control mode. This is to assure that the operator is aware of the set-point valve prior to entering into the control mode.

Setting the Pressure Set-Point

The pressure set-point is the destination of the pressure control algorithm. It should be set before entering Control mode. The pressure set-point is set to zero at power-up or whenever a pressure error occurs.

1. The pressure set-point is set from the Main Menu. (Press PREVIOUS until the Main Menu appears.)
2. Use the numeric keypad to enter the new pressure set-point in the current pressure units.
3. Press ENTER to accept the entry or press CLEAR to clear the numeric scratchpad.

Note

The set-point can also be changed using either the Step or the Jog function. See this Chapter, Step/Jog.

Entering/Exiting Control Mode

1. The Control mode is set from the Main Menu. (Press PREVIOUS until the Main Menu appears.)
2. Press CONTROL [F2] to enter Control mode. ENTER must be pressed to confirm entry into Control mode.
3. Press MEASURE key found in the keypad to exit Control mode. No confirmation is necessary.

Vent

The Vent [F3] function is used to rapidly vent the pressure in the system to atmosphere. This system does not have a designated internal vent valve. Instead, the vent mode is implemented with a fast multi-step procedure. For gauge instruments, the Calibrator controls pressure at the maximum rate towards zero psig. When the primary sensor reads that the pressure is within 1% FS pressure of zero psig, the controller is turned off and the zero solenoid valve that ties the reference port to the test port is opened. This physically vents the test port to atmosphere. If the Calibrator is at a sub-atmospheric pressure, then the system will control to zero psig, at maximum rate, turn off the controller, and open the zeroing solenoid valve, again venting the test port to atmosphere. This function is not available on permanent absolute versions of the RUSKA 7250.

Step/Jog

In addition to entering the pressure set-point through the key-pad, the pressure set-point can be changed using either the step or the jog functions. The Step function is used primarily when the operator is taking pressure steps in equal pressure increments. The size of the pressure step is user defined. The Jog function is most often used when calibrating mechanical gauges such as a dial gauge and the operator wishes to change the pressure until the mechanical gauge indicates a cardinal point. The operator can then read the higher resolution Calibrator to determine the actual pressure value when the mechanical gauge is indicating a cardinal point. The Step/Jog [F5] toggles between Step and Jog, to switch between these modes, press the function key 5 [F5].

Stepping

Assure that the word Step is highlighted in the Step/Jog [F5]. Using the rotary knob, rotate the knob clock-wise to increase the set-point, or counter clock-wise to decrease the controller set-point. The scratchpad will be updated to a new set-point. The step size defaults to 10% of full scale. Press ENTER to accept the new set-point.

Setting Step Size

From the Main Menu, press Menu [F6] | Setup [F2] | User [F2]. Using the rotary knob, move the cursor to highlight Step Size. Enter the desired step size in the current pressure units and press ENTER.

Jogging

Assure that the word Jog is highlighted in the Step/Jog [F5]. From the Main Menu, the pressure set-point can be modified by rotating the rotary knob clockwise to increase pressure and counter-clockwise to decrease pressure. Each increment or decrement will change the pressure in the least significant digit. Continually rotating the rotary knob, the pressure will continue to change until the rotation is stopped.

Menu

The Menu key is used to access the less commonly accessed configuration type functions. This accesses the Setup, Calibration, Program, Test and Display functions.

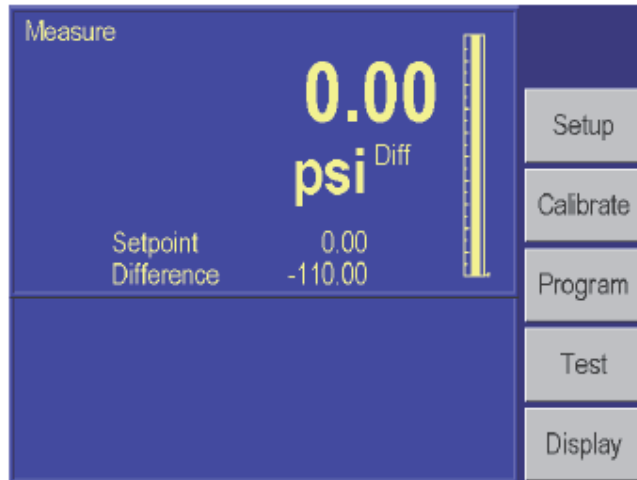

Figure 4-9. Configurations in Menu

gkn020.bmp

Menu | Setup

Setup is used to configure the system. It includes setting all of the limits, user parameters, user-defined units of measure, remote interface and system setup.

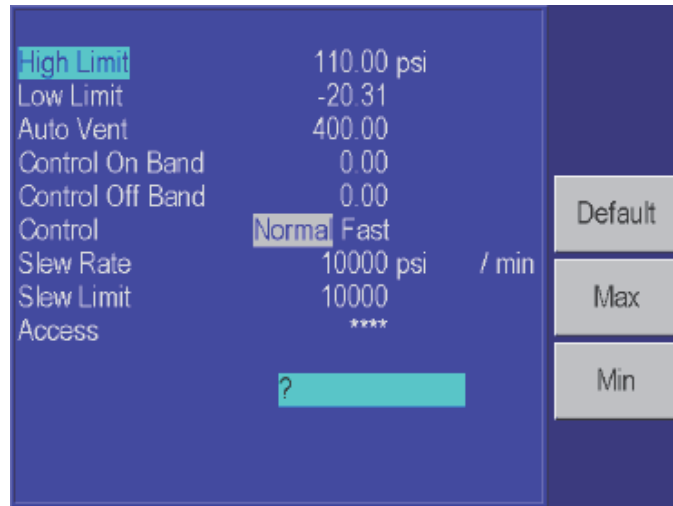

Figure 4-10. Menu | Setup - Menu

gkn040.bmp

Menu | Setup—Limits

The Menu | Setup | Limits menu is used to setup all of the limits in the system. The pressure limits can be used to protect the device-under-test (DUT) from overpressure.



gkn021.bmp

Figure 4-11. Menu I Setup I Limits - Menu

High Limit—User Defined Maximum Pressure Limit

This is often set just over the full-scale pressure of the device under test (DUT) in order to protect the DUT. The Calibrator will then prevent the pressure from exceeding the high limit. If the user enters a value greater than the user defined limit, the unit will not accept the value and it will generate an error code informing the user that they have entered a set-point that is greater than the high pressure limit. In control mode, if for any reason the pressure exceeds the user-defined limit, it will change into the measure mode and again display an error message to the operator informing them of the error that occurred.

This value can be edited using the rotary knob to highlight the High Limit. Then enter the new value using the keypad. This will show up in the scratch pad on the lower portion of the screen. Press the Enter key and the value for the high limit will be updated to the value that was typed into the scratchpad.

Low Limit—User Defined Minimum Pressure Limit

This is the same as the high limit except it is to protect the DUT from low pressure limits.

Auto Vent—User Defined Maximum Pressure

This is the defined maximum pressure the Calibrator can reach prior to venting the test port to atmosphere.

Control Band

There are two common pressure control approaches that are available with the RUSKA 7250. One of the most common control styles is an Active controller where the controller remains operative and holds the pressure at a commanded set-point. This allows the system to hold the pressure at a set-point within the control stability specification (See Appendix A). In addition to possible leaks in a system, following a pressure step, the pressure in the system changes due to temperature effects. When operating an Active control system, the controller continuously monitors any pressure variances in the system and compensates for these effects to hold the pressure at the set-point. The benefit of the Active control is that it can maintain the pressure at the commanded set-point even when there are slight leaks in the system or the system is not thermally stable.

The second approach is to control the pressure in the system to a set-point and then to shut-off the Active controller. We describe this as a Passive control mode. Following a pressure step and the controller becomes passive; the pressure will continue to change in

the system due to thermal effects. However these thermal effects will stabilize over time. Once the system has thermally stabilized, pressure measurements can be made in the system without any “pressure noise” injected into the system as a result of having an Active controller in the system. The result would be that the controller would not add any additional uncertainty to the pressure measurement since it would be inactive during the measurement process. For this method, pressure will not be at a cardinal set-point.

When the Control Off Band and Control On Band are set to zero, the Calibrator operates in the Active control mode. Setting a Control On and Off Band, places the Calibrator in the Passive control mode.

The Control On and Off Band provides a tolerance around the pressure set-point in the current unit of measurement. The Controller will control the pressure to the commanded set-point. Once the actual pressure is within the user defined +/- Control Off Band tolerance, the controller will shut off. The pressure will remain at this level, only changing by the thermal influences or leaks in the system. The controller will remain off until it reaches the +/- Control On Band limit. The controller will then re-activate and control the pressure back to the Control Off Band tolerance. This mode of operation removes any added uncertainty in the measurement system due to the controller since the controller is Passive during the high accuracy pressure measurements.

As an example, if a 100 psi (690 kPa) full scale Calibrator was set-up with the Control Off Band at 0.001 psi (0.007 kPa) and the Control On Band set to 0.005 psi (0.035 kPa). This would place the Calibrator in a Passive control mode. If the Calibrator was placed into the control mode with a pressure set-point of 10 psi (69 kPa), it would control up to the 10 psi (69 kPa) value. Once it reached a pressure of 9.999 psi (68.993 kPa) the active control would turn off. Due to the thermal effects caused by pressurizing the system, the pressure will start reducing in the system. Once the pressure reaches 9.995 psi (68.965 kPa) the active controller would automatically turn on and control the pressure back to 9.999 psi (68.993 kPa) and then turn off. After a few cycles, the system will thermally stabilize and the pressure will hold between the Control On and Control Off Bands.

Control

The Calibrator has two control modes of operation, Normal and Fast. In the Normal mode, minimizing pressure overshooting takes precedence over control speed. In the Fast Mode, control speed takes precedence over overshooting the commanded set-point.

Supply Correction

The control performance of the RUSKA 7250sys is optimized when the fully supply pressure is provided to each of the controller ranges in the system. When inadequate supply pressure is present, the control performance will suffer. When the Supply Correction function is turned on, the system adjusts the control parameters to improve the control when it detects insufficient supply pressure.

Slew Rate

User defined maximum pressure rate of change. The RUSKA 7250 is designed to control with minimum overshoot into a wide variety of external volumes at its highest slew rate. Therefore, in most applications it is recommended that the slew rate be set at its maximum rate value. This provides the highest speed control without jeopardizing overshoot or control stability properties. The only application where the operator may wish to slow down the slew rate (control speed) is in applications where the device under test could be damaged by high rate of pressure change. The Calibrator control algorithm tries to limit the rate of pressure change to the slew rate. On Calibrator's with full scale pressures ranges less than 10 psi (70 kPa), it is common to reduce the slew rate to less than 25% of full scale to improve on control overshoot characteristics.

Slew Limit

The slew limit is used by the system to assure that the slew rate is not exceeded. If the slew rate is exceeded, the Calibrator will change from the control mode to the measure mode and it will generate an error message to the operator.

Access

The test access password allows the user to protect access to the RUSKA 7250's configuration and programs. If the test access password is set to any number other than zero (factory default), it is *required* before the user is allowed to change the limits, control parameters or programs.

Note

It is recommended that the access password be recorded and filed in a secure location.

Menu | Setup—User

The Menu | Setup | User menu is used to setup all of the user specific configurations. This includes setting the control step size, range of bar-graph, pressure gas head, display pressure filter, display resolution digits, and audible key click.

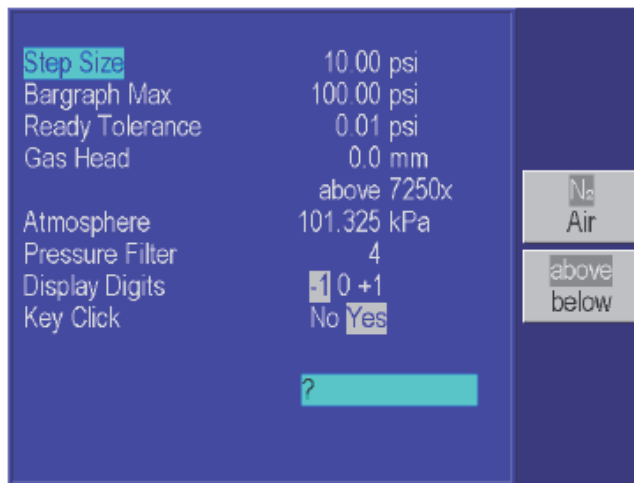

Figure 4-12. Menu | Setup | User - Menu

gkn022.bmp

Step Size

In addition to entering the pressure set-point by the key-pad, the pressure set-point can be changed using the step function. The step function is used primarily when the operator is taking pressure steps in equal pressure increments. The size of the pressure step is user defined. From the Main Menu, press Menu [F6] | Setup [F2] | User [F2]. Using the rotary knob, move the cursor to highlight Step Size. Enter the desired step size in the current pressure units and press ENTER.

Bar Graph Maximum

The bar graph on the Main Menu screen can be scaled to match the device under test by setting the full scale value of the bar graph.

Ready Tolerance

A Ready indication is generated when in control mode and the measured pressure is reading within this ready tolerance value. When running an internal program, the ready indicator is shown when the measured pressure is within the tolerance stored in the program.

Gas Head Pressure Correction

The term “head height” refers to the vertical distance between the sensing element in the device under test and the Calibrator’s pressure reference plane. Once the user inputs the head height and selects air or nitrogen, the Calibrator automatically corrects for head pressure.

1. The Pressure Reference Line on the RUSKA 7250 is defined as the bottom of the color display where the display and the front panel join. This provides the *reference plane* against which the device under test (DUT) pressure is measured.
2. Determine the vertical distance between the Calibrator Pressure Reference Line and the reference plane of the device under test.
3. Press the Unit key found in the keypad and press in/mm [F1] to select either inches (in) or millimeters (mm) for the head height entry.
4. The head height is set from the Menu | Setup | User. From the Main Menu (press PREVIOUS until the Main Menu appears), press Menu [F6] | Setup [F2] | User [F2].
5. Press Medium [F3] to select either “Air” or “Nitrogen”. The selected units will be highlighted.
6. Press Position [F4] to select if the position of the Device Under Test is either “Above” or “Below” the RUSKA 7250. The selected units will be highlighted and appear in the Gas Head description.
7. Use the rotary knob to highlight the label “Gas Head”.
8. Use the numeric keypad to enter the height in the selected unit.
9. Press ENTER To accept the entry.

Atmosphere

The nominal barometric pressure value for the location that the Calibrator is utilized should be entered for atmosphere. On gauge mode instruments, this number is used to calculate the density of the test port pressure medium and to correct for head pressure variances between the reference port of the Calibrator and the DUT.

Pressure Filter

This is used to adjust the degree to which the front display pressure value is filtered. A value of four (4), is the default value. As the value increases, the filtering level increases, however, the display update rate reduces. Typical filter values would range from 1 to 10.

Changing the Number of Decimals

Each unit has a default number of decimal places used for pressure display. This may be adjusted up or down by one decimal place.

1. The decimal digits are set from the Menu | Setup | User. From the Main Menu (press PREVIOUS until the Main Menu appears), press Menu [F6] | Setup [F2] | User [F2].
2. Turn the rotary knob until the label “Display digits” is highlighted.
3. Turn the rotary knob further until the desired number of digits from the default resolution is highlighted (-1, 0, +1), and then press the ENTER key to select.

Key Click

The RUSKA 7250 can be configured to emit a “clicking” sound each time a key is pressed.

1. The key “click” is set from the Menu | Setup | User. From the Main Menu (press Previous until the Main Menu appears), press Menu [F6] | Setup [F2] | User [F2].
2. Turn the rotary knob to highlight “Key click” and then highlight either on or off.
3. Press the ENTER key to select.

Menu | Setup—Units

In addition to the standard units of measure provided by the RUSKA 7250, four user-defined units are available. To create a user-defined unit, the user enters a *name* that is one to ten characters long and a *conversion factor* that is a multiple of kiloPascals (kPa).

For example, using the information from Table 2-1, the conversion factor for millitorr or one micron of mercury at 0 °C is calculated as follows.

$$mTorr = kPa \times \frac{1000 \text{ mTorr}}{1 \text{ Torr}} \times \frac{1 \text{ Torr}}{1 \text{ mmHg } 0^{\circ}\text{C}} \times \frac{1 \text{ mmHg } 0^{\circ}\text{C}}{0.0193377 \text{ psi}} \times \frac{0.1450377 \text{ psi}}{1 \text{ kPa}}$$

thus the conversion factor simplifies to $mTorr = kPa \times 7500.6180$



Figure 4-13. Menu | Setup | Units - Menu

gkn023.bmp

1. The pressure units are defined from the Menu | Units | Define. From the Main Menu (press PREVIOUS until the Main Menu appears) press Menu [F6] | Setup [F2] | Units [F3].
2. Use the rotary knob to highlight the desired user-defined unit, and then select the Edit Name [F1] function key.
3. The following sequence is used to change the name of the selected unit.



gkn024.bmp

Figure 4-14. Menu | Setup | Units | Edit Name - Menu

Use the < [F4] or > [F5] key to highlight the desired character in the matrix.

- a. Use the rotary knob to change the character.
 - b. Repeat steps a and b until the desired name is entered. Press the Clear key to start over.
 - c. Press the Done [F6] key when the name change is completed.
4. Use the rotary knob to highlight the desired user-defined unit that has just been renamed.
 5. Use the numeric keypad to enter the conversion factor and press ENTER to accept.
 6. Press PREVIOUS three times to return to the Main Menu. The new unit definition may now be selected using the Units key.

Menu | Setup—Remote

The Menu | Setup | Remote screen is where the remote communication interface is set-up.

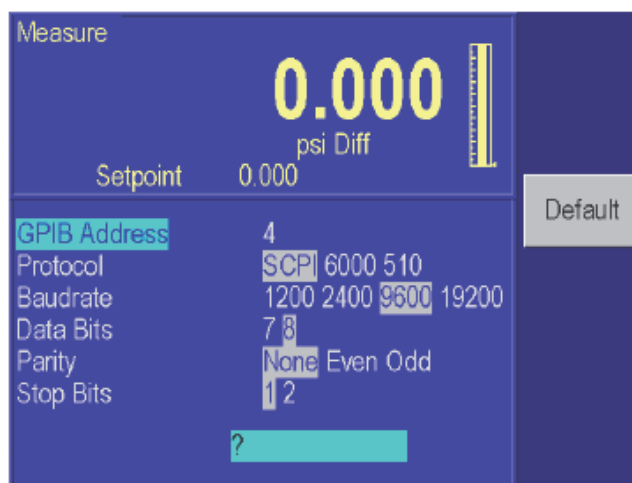

gkn025.bmp

Figure 4-15. Menu | Setup | Remote - Menu

GPIB Address

Sets the IEEE-488 interface address.

Protocol

The Protocol defines which protocol should be used by the remote interface. The options are Standard Communication for Programmable Instruments (SCPI) which is the standard interface, 6000 to emulate the RUSKA Series 6000 Pressure Controller, and 510 to emulate the Druck Model 510 Pressure Controller. When using the SCPI interface, the RUSKA 7250 will emulate the RUSKA 7010 and 7215 Series Controllers.

Serial Interface Set-Up

The operator can set-up the Baud Rate, Data Bits, Parity, and Stop Bits for the Serial Interface.

Menu | Setup—System

The System Menu identifies the Software release version that is being operated in the Calibrator. It also stores and allows the operator to edit the Date and Time.

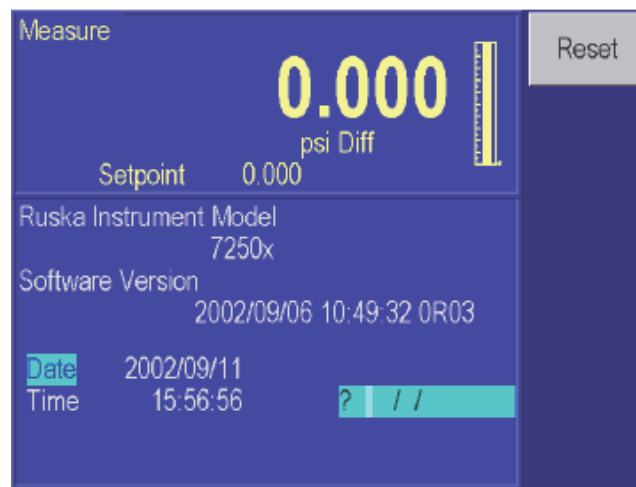

Figure 4-16. Menu | Setup | System - Menu

gkn026.bmp

Date/Time

The Calibrator's system clock is continuously updated. If the date or time requires editing, the following applies;

1. The date and time are set from the Setup | System | Menu. From the Main Menu (press PREVIOUS until the Main Menu appears), press Menu [F6] | Setup [F2] | System [F5].
2. To set the system date, turn the rotary knob until Date is highlighted. Use the numeric keypad to enter the current four-digit year, month, and day (yyyymmdd). All digits must be entered. Press ENTER to accept.
3. To set the system time, turn the rotary knob until Time is highlighted. Use the numeric keypad to enter the current hour, minute, and second (hhmmss). All digits must be entered. Press ENTER to accept.

Reset

The Reset [F1] command is used to re-boot the Calibrator.

To reset the system, from the Main Menu (press PREVIOUS until the Main Menu appears), press Menu [F6] | Setup [F2] | System [F5] | Reset [F1].

Menu | Calibrate

The Menu | Calibrate command is used to perform the calibrations on all of the sensors utilized by the RUSKA 7250. The RUSKA 7250 can be completely calibrated using the front panel interface. It does not require any external computer or software in order to perform a successful calibration. It also has the capability of being calibrated remotely through either the RS232 or IEEE-488 interface. The RUSKA 7250 will guide the operator through a menu driven calibration procedure identifying the pressures that should be supplied by a standard. Following the calibration procedure, the Calibrator calculates and saves its own coefficients. The calibration coefficients are date stamped so the user can easily identify the last time the instrument went through a full calibration, when the coefficients were last edited or when the Calibrator was re-zeroed.

The calibration section in the RUSKA 7250 can be password protected to prevent any unauthorized entry into the calibration section of the system. Refer to Chapter 6, Maintenance, of the manual for more detailed information regarding the calibration of the RUSKA 7250.

Calibration Password

The calibration password allows the user to protect access to the RUSKA 7250's calibration constants and the calibration procedure. If the calibration password is set to any number other than zero, it is *required* before the user is allowed to calibrate the RUSKA 7250 or manually change the calibration constants.

Note

It is recommended that the access password be recorded and filed in a secure location.

1. The calibration password is set from the Calibration Menu. From the Main Menu (press PREVIOUS until the Main Menu appears), press Menu [F6] | Calibrate Menu [F3] | Calibrate | Edit.
2. Press the Access [F4] key. If there is a password in the system other than 0, then you must enter the current valid password into the Calibrator before it will allow you to modify the password.
3. Use the numeric keypad to enter the new calibration password. Setting the calibration password to zero allows free access to calibration and constants. Press ENTER.
4. Press Yes [F4] to acknowledge changing the calibration password. Press No [F5] to reject changing the calibration password.

Zeroing

Fluke recommends that the Calibrator be zeroed once a day to maintain optimal performance. The zero drift specification is defined in Appendix A under General Specifications. Refer to Chapter 6, Calibration, Editing the Calibration Coefficients, for the zeroing procedure. On gauge mode instruments, the zeroing procedure automatically ties both test and reference ports of the RUSKA quartz sensor together and performs the zeroing routine.

On permanent absolute instruments, a vacuum pump and vacuum gauge is required to zero the instrument. The optional vacuum gauge sensor should be installed in a port that is located internally to the RUSKA 7250 very near to the RUSKA quartz sensor. See Chapter 3, Pneumatic Connections, Vacuum Sensor - Option, for proper vacuum gauge installation instructions. When initiating the zeroing command in the Calibrator, it will cycle the internal valves allowing the external vacuum pump to pull a hard vacuum on the RUSKA sensor. It is recommended that the sensor be pulled down to a vacuum of less than 200 mTorr (preferably less than 100 mTorr) in order to obtain a proper zero. The Calibrator can be zeroed at higher vacuum levels; however, the uncertainty of

vacuum sensors tend to increase at higher vacuum levels, therefore, the uncertainty in the Calibrator would also increase if zeroed at higher vacuum levels. Once the vacuum level is stable, the user enters the vacuum level as indicated by the vacuum gauge and then the zeroing procedure completes. Refer to Chapter 6, Maintenance, of the manual for more detailed information regarding the zeroing procedure of the Calibrator.

Menu | Program—Storing A Sequence in Memory

Consider an exercise that requires the Calibrator to start at 30 psi, increase to 50 psi, then decrease to 20 psi. Test sequences like this may be stored in the Calibrator's memory as a *program*.

One benefit of storing a sequence in memory is that the user does not have to command each pressure separately every time a multipoint test or calibration routine is performed. Another benefit is that the user can specify a tolerance for each set-point pressure. Once a tolerance is set, the dwell timer will start counting down instead of waiting until the pressure is at the exact set-point to start the dwell timer. This gives the user a time advantage compared to manual mode operation and provides a degree of automation without the use of an external computer.

The RUSKA 7250 can store up to 1,000 program steps that may be divided among a maximum of 20 named programs.

Preparing to Program

Before entering a test sequence, consider the items discussed below.

Program Name

Valid program names range from one to eight characters in length and can include numbers, upper case letters, and the /, %, and # symbols. For example, Exer#14 and %FStest are both valid names.

Configuration

Since a program will depend on the current setup of the Calibrator (the current configuration is stored with the program) the user should set the units, limits, control parameters, etc., to the desired values before creating a program.

Number of Set-points

Before entering the sequence, the user should determine the number of upscale and downscale set-points required to complete the exercise.

Set-point Pressure and Tolerance

Each set-point in the program requires both a pressure and a tolerance, in the current units of measure. For example, one set-point might require a tolerance as low as 0.05 psi (0.35 kPa), whereas another set-point in the same program could be satisfied with a tolerance as high as 5 psi (0.35 kPa).

Dwell Time

Once the pressure is within the specified tolerance, the Calibrator starts a timer that runs for a user-defined number of seconds. This is referred to as *dwell time*. As long as this timer is running, the Calibrator will remain at the designated set-point unless the *max time* (see below) elapses. When the *dwell time* expires, the Calibrator will proceed to the next step. Typically the *dwell time* should be set to a value less than the *max time*.

Usually *dwell time* has a value of a few seconds, but a value of 0 can be used to create a pause in the program. When *the dwell time* is set to zero, the Calibrator switches to manual control once it is within the tolerance value of the set-point pressure. The user must then press a key on the front panel to continue the program.

MaxTime

The *max time* is the maximum time in seconds, including the *dwell time*, that the Calibrator can spend on one step of the program. After the *max time* elapses, the Calibrator will automatically proceed to the next set-point in the program, even if the current set-point has not been achieved. Thus, the *max time* selection limits the amount of time that the Calibrator can spend on any one set-point. Typically the *max time* should be set to a value greater than the *dwell time*. If the *max time* is set to zero, the Calibrator will attempt to achieve the set-point indefinitely (i.e. the *max time* function is disabled).

Mode of Entry

If the upscale portion of the desired pressure step sequence and the downscale portion of the sequence both have the same highest and lowest set-points and consist of evenly spaced steps, the <Auto> option can be used to automatically generate the program. However, if any part of the sequence includes unevenly spaced steps, or the starting and ending set-points are not the same, each step must be programmed individually. In the example given at the beginning of this section, Menu | Program—Storing A Sequence in Memory, each step must be programmed individually since the starting set-point is 30 psi and the ending set-point is 20 psi.

Detailed instructions for entering these items are given in the sections that follow.

Entering a New Program

To program the Calibrator, use the keys on the front panel to change values on the Calibrator's program editing screen. Instructions for entering each step of a new program are included below.

1. Ensure that the units, limits, and control parameters have been set to the desired values.
2. The program is entered from the Program menu. From the Main Menu (press PREVIOUS until the Main Menu appears), press Menu [F6] | Program [F4].

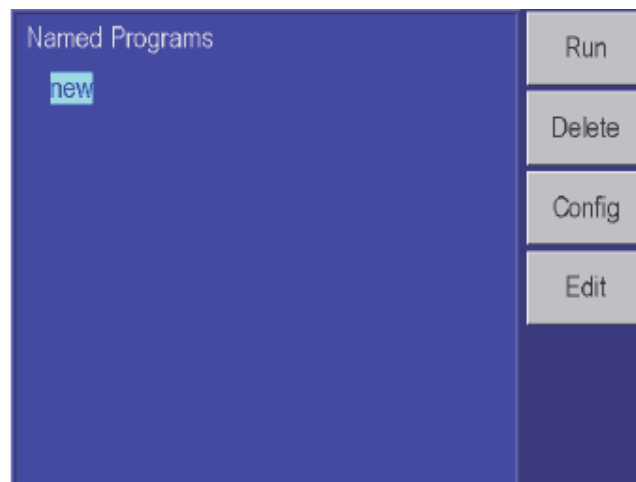
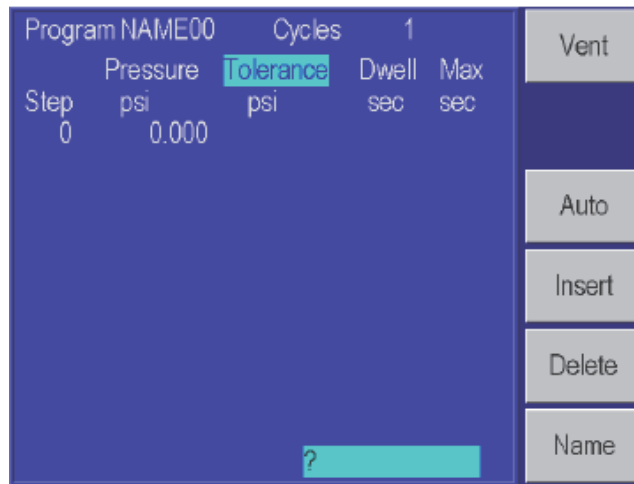

Figure 4-17. Menu | Program - Menu

gkn027.bmp

3. Use the rotary knob to highlight "new".
4. Press Edit [F4]. Since "new" was highlighted, the RUSKA 7250 will create a new program and give a default name of NAMEnn, where nn is a two digit number. The program editing screen will appear, displaying the first step.



gkn028.bmp

Figure 4-18. Menu | Program | Edit - Menu

5. Using the numeric keypad, enter the values for Pressure, Tolerance, Dwell time, and Max time, pressing ENTER after each value. The rotary knob may be used to skip fields.
6. At the 0 step, enter the next pressure and the Calibrator will automatically insert a new pressure step.
7. Repeat steps 5 and 6 until the test sequence is complete. The Tolerance, Dwell time and Max time will default to the value programmed in the first program step, and only need to be changed if a different value is desired for a particular step.
8. It is often suggested that the last point in a calibration program is to vent the pressure to atmosphere. This can be achieved by selecting the VENT function key as the pressure set-point. (Note, you can use the vent as a set-point at any point in the program. The dwell and max time function with vent just as they would at a controlled set-point.)
9. When all steps have been entered, press PREVIOUS to return to the Named programs screen. See the section below, Changing the Name of a Program, for creating a user-defined program name.

Automatically Generating a Program

For the Calibrator to automatically generate a program, the user must input the first set-point pressure, the last set-point pressure, and the number of steps in between, as well as the dwell time, max time and tolerance common to all set-points.

1. Ensure that the units, limits, and control parameters are set to their desired values.
2. The program is entered from the Program menu. From the Main Menu (press PREVIOUS until the Main Menu appears), press Menu [F6] | Program [F4].
3. Use the rotary knob to highlight “new”. If these steps are used on an existing program, all program steps will be deleted and replaced with the automatically generated program.
4. Press Edit [F4]. Since “new” was highlighted, the RUSKA 7250 will create a new program and give a default name of NAME_{nn} where nn is a two digit number. The program editing screen will appear, displaying the first step.
5. Press Auto [F3].

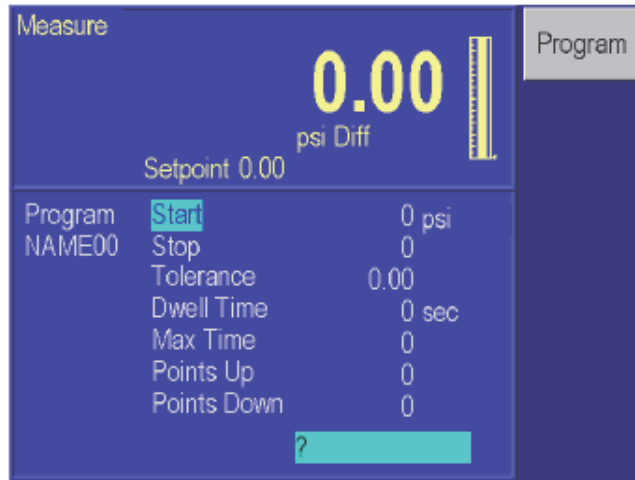

gkn029.bmp

Figure 4-19. Menu | Program | Edit | Auto - Menu

- Using the numeric keypad, enter the values for Start, Stop, Tolerance, Dwell time, Max time, number of pressure Points up, and number of pressure Points down, pressing ENTER after each value. The rotary knob may be used to skip fields.
- Press Program [F1]. The program will be generated and the display will show the first step.
- Press the Name [F6] key to edit the name of the program. See Chapter 4, below, Changing the Name of a Program, for creating a user-defined program name.

Changing the Name of a Program

- The name of an existing program is changed from the Program menu. From the Main Menu (press PREVIOUS until the Main Menu appears), press Menu [F6] | Program [F4]. In addition to changing the name of an existing program, a new program may be initiated by selecting “new” and performing the same steps as outlined to change the name of a program.
- Use the rotary knob to highlight the current name. (For a new program name, select “new”.)
- Press Edit [F4]. The program editing screen will appear, displaying the first step.
- Press Name [F6].

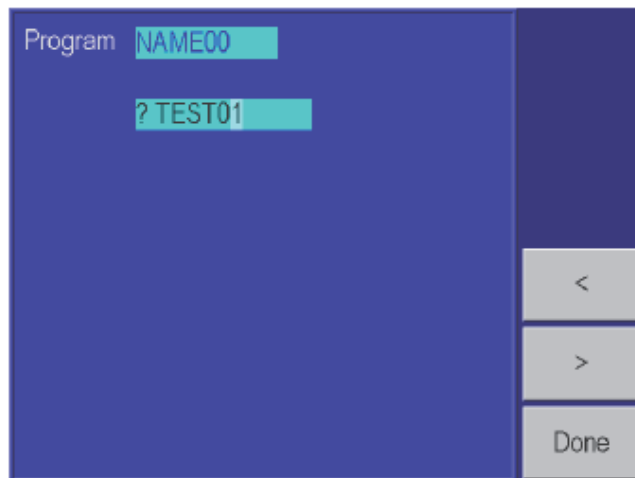

gkn030.bmp

Figure 4-20. Menu | Program | Edit | Name - Menu

5. Use the < [F4] and > [F5] keys to highlight a character.
6. Turn the rotary knob to select the character from the character set.
7. To correct a mistake, press Clear [F4] and return to step 5.
8. Repeat steps 5 and 6 until the name is complete.
9. Press Done [F6] to store the contents of the scratchpad as the new name of the program.

Changing an Existing Program

Instructions for changing an existing sequence are given below. Both manually and automatically generated programs may be edited.

1. Programs are changed from the Program Menu. From the Main Menu (press PREVIOUS until the Main Menu appears), press Menu [F6] | Program [F4].
2. Use the rotary knob to highlight the name of the program.
3. Press Edit [F4]. The program editing screen will appear as a table showing all of the steps.

Step	Pressure psi	Tolerance psi	Dwell sec	Max sec
1	0.0000	0.0010	5	100
2	20.0000	0.0010	5	100
3	40.0000	0.0010	5	100
4	60.0000	0.0010	5	100
5	80.0000	0.0010	5	100
6	100.0000	0.0010	25	100
7	50.0000	0.0010	5	100
8	0.0000	0.0010	5	100
0	0.0000			

Auto
Insert
Delete
Name

?

gkn031.bmp

Figure 4-21. Menu | Program | Edit - Menu

4. The rotary knob can be used to move through the program and highlight the value you wish to edit. Use the keyboard to enter a new value. This value will show up in the scratch pad located at the bottom of the window. Press ENTER to accept the edited value.
5. To add a step to the program, first move to the step *after* the new step. For example, to insert a step between steps 3 and 4, move to step 4. Press Insert [F4].
6. To delete a step in the program, first move to the step to be deleted, then press Delete [F5].
7. When all changes have been made, press PREVIOUS to return to the Named programs screen. The Calibrator automatically saves the changes that were made in the program.

Changing the Configuration Stored with a Program

1. Programs are configured from the Program menu. From the Main Menu (press PREVIOUS until the Main Menu appears), press Menu [F6] | Program [F4].
2. Use the rotary knob to highlight the name of the program.

3. Press Config [F3]. The configuration screen will appear.
4. Press Recall [F2]. The Calibrator will be set to the configuration stored with the program.

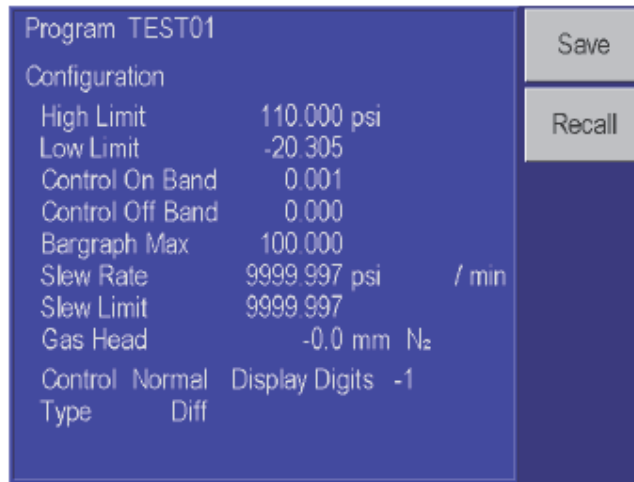

Figure 4-22. Menu | Program | Config - Menu

gkn032.bmp

5. Press PREVIOUS until the Main Menu appears.
6. Press Setup [F2] | Limits [F1]. Change the desired parameters using the normal procedures.
7. Return to the Main Menu by pressing PREVIOUS three times.
8. Press Menu [F6] | Program [F4].
9. Use the rotary knob to highlight the name of the program.
10. Press Config [F3] | Save [F1]. The configuration of the Calibrator will be changed to the current settings and stored in the program's configuration.

Running a Program

1. Programs are run from the Program Menu. From the Main Menu (press PREVIOUS until the Main Menu appears), press Menu [F6] | Program [F4].
2. Use the rotary knob to highlight the name of the program.
3. Press Run [F1]. The program run screen will appear. "Stop" will be highlighted, showing that the program is not currently running.



gkn033.bmp

Figure 4-23. Menu | Program | Run - Menu

4. Press Run [F2]. The configuration of the RUSKA 7250 stored with the program is restored, the pressure set-point is set to the pressure value in the first step, and the Calibrator is placed in Control mode. "Run" will now be highlighted and the program will proceed through its steps.
5. To pause the program, press Pause [F3]. Pause will now be highlighted and the Calibrator will continue controlling to the current set-point. The Calibrator will maintain control of the current set-point until further instructions from the operator. Press Continue [F4] to resume the program.
6. To stop the program, press Stop [F5]. The program will stop running but the Calibrator will continue controlling to the current set-point.

Menu | Test

The Menu | Test section of the system is used to perform a number of the diagnostic and tuning functions that are available with the RUSKA 7250.



gkn034.bmp

Figure 4-24. Menu | Test - Menu

Menu | Test—Sweep Test

The sweep function can be used to automatically exercise the elastic sensing element of the device under test prior to performing a calibration. For the RUSKA 7250 to perform the sweep test, input the high and low set-point pressures, the pressure control tolerance, the dwell time at set-point, and the number of cycles to perform.

1. Ensure that the units, limits, and control parameters are set to their desired values.
2. The sweep test is entered from the Sweep Test menu. From the Main Menu, (press PREVIOUS until the Main Menu appears), press Menu [F6] | Test [F5] | Sweep [F2].
3. Enter the high and low pressure points, the control tolerance, dwell time, and the number of cycles.



Figure 4-25. Menu | Test | Sweep - Menu

gkn035.bmp

7. Press Run [F2] to initiate the test.
8. To pause the program, press Pause [F3]. Pause will now be highlighted and the Calibrator will continue controlling to the current set-point. The Calibrator will maintain control of the current set-point until further instructions from the user. Press Continue [F4] to resume the program.
9. To stop the program, press Stop [F5]. The program will stop running but the Calibrator will continue controlling to the current set-point.

Menu | Test—Self Test

The RUSKA 7250 can perform electrical and pneumatic self test to assist in troubleshooting potential problems. Refer to Chapter 6, Maintenance, for more details.

Note

In order to perform a pneumatic self test, the supply port must be connected to a properly set supply pressure and the test port not open to atmosphere. For absolute units, a vacuum supply must also be connected to the exhaust port.

Menu | Test—Remote Test

The Menu | Test | Remote section of the system is used to perform a number of the diagnostic functions on the remote interface. It can be used to display the transmitted and received messages that are sent across the interface. This can be a powerful tool to assist in identifying the source of communication problems.

The Menu | Test | Remote menu displays information from the IEEE-488 interface. Pressing the Serial 1 [F2] or Serial 2 [F3] keys will display information from the serial ports.

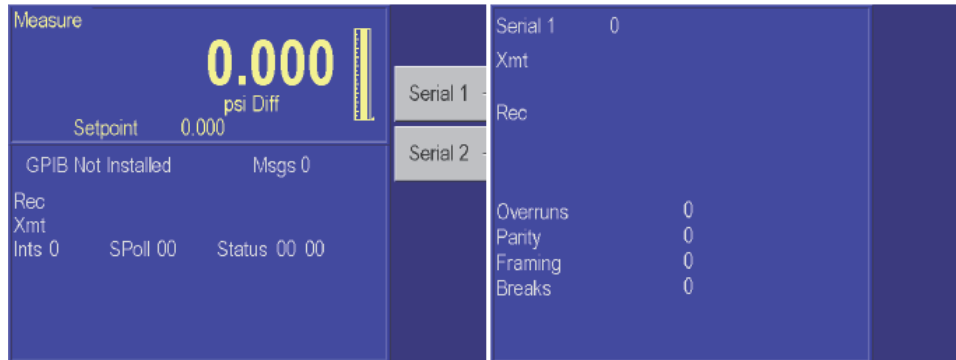

Figure 4-26. Menu | Test | Remote - GPIB Menu & Serial1 Menu

gkn036.bmp

Menu | Test—Shop1

The Menu | Test | Shop1 menu of the system is used to display the current status of the various valve positions in the system. This menu is primarily used for diagnostics and will be discussed further in Chapter 6, Maintenance.

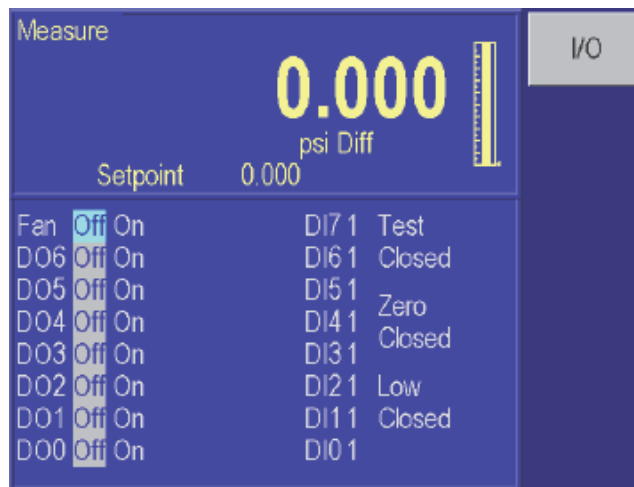

Figure 4-27. Menu | Test | Shop1 - Menu

gkn037.bmp

Menu | Test—Control

The Menu | Test | Control menu of the system is used to tune the controller. On new instruments, the controller is tuned at the factory and therefore, the user should not need to access or make any adjustments to the controller using this menu. This menu is user accessible in order to provide a means to set-up the controller when control valves are replaced or to perform maintenance on the controller. This menu is primarily used for diagnostics and repairs, and will be discussed further in Chapter 6, Maintenance.

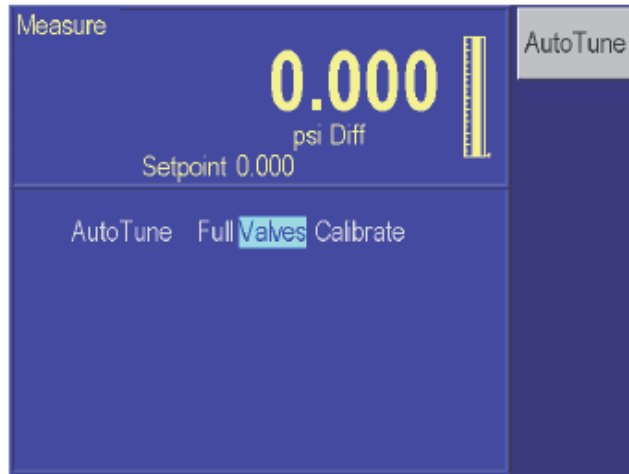

Figure 4-28. Menu | Test | Controller - Menu

gkn038.bmp

Menu | Display

The Menu | Display is used to conveniently monitor most of the sensor output parameters. It is primarily used for troubleshooting.

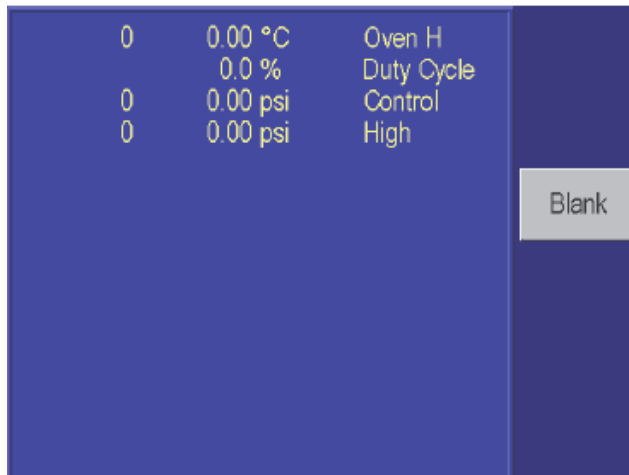

Figure 4-29. Menu | Display - Menu

gkn039.bmp

Menu | Display—Blank

Menu | Display—Blank is used as a screen saver in the 7250.

Chapter 5

Remote Operation

Capabilities

The RUSKA 7250 can be operated remotely by a computer. Two interfaces are supported: IEEE-488 and RS-232. Both interfaces support SCPI (Standard Commands for Programmable Instruments). The IEEE-488 interface additionally supports emulation of a RUSKA Single Channel Interface Panel (Models 6005-701 and 6005-761). The IEEE-488 interface conforms to the following standards:

ANSI/IEEE Std 488.1-1987	IEEE Standard Digital Interface for Programmable Instrumentation
ANSI/IEEE Std 488.2-1987	IEEE Standard Codes, Formats, Protocols, and Common Commands
SCPI 1991.0	Standard Commands for Programmable Instruments

IEEE-488

The following identification codes define the interface capabilities of the RUSKA 7250. Identification codes are described in the IEEE-488 standard.

SH1	Source Handshake, Complete Capability
AH1	Acceptor Handshake, Complete Capability
T5	Talker
L3	Listener
SR1	Service Request, Complete Capability
RL1	Remote-Local, Complete Capability
PP0	Parallel Poll, No Capability
DC1	Device Clear, Complete Capability
DT0	Device Trigger, No Capability
C0	Controller, No Capability

The IEEE-488 interface is installed next to the processor board. The interface is identified by the IEEE-488 standard connector on the back panel of the unit.

Note

Do not change any jumpers or switch settings on the IEEE-488 interface board. The IEEE-488 address is set by the Menu /Setup/Remote screen.

RS-232

The RS-232 interface supports standard serial operation from a computer to a single RUSKA 7250. RS-232 supports the IEEE-488.2 and SCPI commands. The RUSKA 7250 allows the following port setups:

Baud Rate	1200, 2400, 9600, or 19200
Data Bits	7 or 8
Parity	Even, Odd, or None
Stop Bits	1 or 2
Handshaking	XON/XOFF

The RS-232 connection is a DB-9P connector found on the back panel of the RUSKA 7250. It is located on the processor board. The following pins are used; all other pins are reserved.

Pin #	Direction	Signal
2	In	RXD Receive Data
3	Out	TXD Transmit Data
5	—	GND Ground
7	Out	RTS Request to Send

Remote/Local Operation

In Local mode, the RUSKA 7250 is operated manually through the front panel. Chapter 4 covers local operation. The Calibrator always powers up in the Local mode. In Remote mode, the RUSKA 7250 is operated by a computer connected to an interface. Most functions that can be performed in Local mode can also be performed remotely.

Remote mode does not automatically disable local operation. The remote interface may be active while local operations are being done. In cases where full remote control is required, the following methods may be used.

1. Issue a Local Lockout (LLO) interface message via the IEEE-488 interface. The Calibrator will disable the local keyboard until the Go To Local (GTL) interface message is received or the REN (Remote Enable) line is unasserted. This method cannot be used on the serial interface.
2. Issue the SCPI command “SYSTEM:KLOCK ON” to lock the local keyboard. The Calibrator will disable the local keyboard until the command “SYSTEM:KLOCK OFF” is received.
3. Issue the SCPI command “DISPLAY:ENABLE OFF or DISPLAY:TEXT <string>”. These commands will disable the local display in addition to locking the keyboard. The command “DISPLAY:ENABLE ON” will restore the local display and keyboard operation.

Local operation may also be restored by turning the Calibrator off and back on.

Configuration

The remote interface must be configured before it is connected. The remote interface is configured using the local interface. The parameters needed vary with the interface used.

IEEE-488	Address, Protocol
RS-232	Baud Rate, Data Bits, Parity, Stop Bits

To configure the remote interface:

1. The remote interface is configured from the Setup | Remote | Menu. From the Main Menu (press PREVIOUS until the Main Menu appears), press Menu [F6] | Setup [F2] | Remote [F4].
2. Use the rotary knob to highlight the desired parameter.
3. Use the numeric keypad to enter the address; use the rotary knob to change the other parameters. The ENTER key must be pressed after entering the address.
4. Repeat steps 2 and 3 to set all parameters needed.

Device Messages

SCPI Command Format

SCPI mnemonics have two forms: long and short. The short form is all in capital letters. The long form is the entire mnemonic. Commands may use either the short form or the entire long form. No other forms are accepted. SCPI ignores case: uppercase and lowercase are equivalent.

A SCPI command is made by following the command tree as presented in the command summary. Each level adds a mnemonic to the command separated by colons (:). Mnemonics enclosed in square brackets are optional and may be omitted.

Some mnemonics are followed by an optional numeric suffix. If omitted, the suffix defaults to 1.

Multiple commands may be placed in a single message separated by semicolons (;). Each command starts at the same level of tree where the last command stopped, unless the command starts with a colon. The first command in a message and any commands starting with a colon start at the root of the command tree. IEEE 488.2 commands may occur between SCPI commands without affecting the tree level.

Command parameters are separated from the command name by one or more spaces. Multiple parameters are separated by commas (,). SCPI accepts numeric parameters with optional sign, decimal point, and exponent. OFF is equivalent to zero and ON is equivalent to one. Floating point numbers are rounded to the nearest integer for commands accepting integer values only.

A message is terminated by a line feed (hexadecimal 0A). Carriage returns, tabs, and other control characters are ignored.

SCPI Response Format

Most values can be queried by appending a question mark (?) to a command and not specifying any parameters. Commands ending with a question mark (?) in the command summary cannot be set only queried. Multiple values from a single command are separated by commas. Responses from different commands in the same message are separated by semicolons (;). The response message is terminated by a line feed (hexadecimal 0A).

Integer responses are returned as one or more digits. Boolean values (ON and OFF values) are always returned as numbers, with zero for OFF and one for ON. Floating point values are returned in the format “+d.dddddddE+dd.”

ANSI/IEEE 488.2-1987 Command Summary

*CLS	Clear Status
*ESE?	Event Status Enable Query
*ESE <number>	Event Status Enable
*ESR?	Event Status Register
*IDN?	Identification
*OPC?	Operation Complete Query (Returns 1)
*OPC	Operation Complete
*RST	Reset
*SRE?	Service Request Enable Query
*SRE <number>	Service Request Enable
*STB?	Status Byte Query
*TST?	Self-Test Query
*WAI	Wait (No operation)

SCPI Command Summary

The current value associated with a SCPI command may be read by appending a question mark to the command. For example CALC:LIM:UPP? will return the current upper pressure limit.

MEASure	
[:PRESsure]?	Returns Current Pressure Reading
:TEMPerature2?	Returns Oven Temperature
:TEMPerature3?	Returns Oven 2 Temperature (7250xi only)
:PRESSure2?	Return Case Pressure
:PRESSure3?	Return Barometric Reference Pressure
:SLEW?	Returns Pressure Slew Rate (units/sec)
CALCulate	
:LIMit	
:LOWer <number>	Get/Set Low Pressure Limit
:SLEW <number>	Get/Set Slew Rate Limit
:UPPer <number>	Get/Set High Pressure Limit
:TARE	
:VALUE <number>	Get/Set Tare Value
:STATe ON/OFF	Set Tare state using current pressure
CALibration	
[:PRESsure]	
:VALue<n> <number>	Perform calibration point
:DATA	
:POINTs?	Number of calibration constants
:VALue<n>?	returns cal. constant label, value
:VALue<n> <number>	Set calibration constant
:CALibration	
:POINTs?	Number of calibration points
:VALue?	Nominal calibration point
:DATE?	Last calibration date
:TIME?	Last calibration time
:ZERO	Performs Zero Calibration
:VALUE<number>	Sets Vacuum Value
:INITiate	Enter Zero Calibration Mode
:INITiate?	Status for Cal, Pressure, Temp., Reference
	Cal: 0=Not Zeroing,
	1=Local Zero,
	2=Remote Zero
	Pressure, Temperature, Reference:
	-1=Out of Range
	0=Stable
	>0=Time until stable
:RUN	Start Zero Calibration

```

:DATE?                               Last zero date
:TIME?                               Last zero time
:PRESSure2                           Case reference sensor
:VALue<n> <number>                 Perform calibration point
:DATA
  :POINTs?                           Number of calibration constants
  :VALue<n>?                          returns cal. constant label, value
  :VALue<n> <number>                 Set calibration constant
:CALibration
  :POINTs?                           Number of calibration points
  :VALue?                              Nominal calibration point
  :ZERO <number>                     Zero sensor to value
:PRESSure3                           Reference sensor
  Same as PRESSure2 above
:PRESSure4PDCR                       sensor
  Same as PRESSure2 above
:VACuum
  Same as PRESSure2 above
:TEMPerature                         Gas Temperature
  Same as PRESSure2 above
:TEMPerature2                       High Sensor Temperature
  Same as PRESSure2 above
:TEMPerature3                       Low Sensor Temperature
  Same as PRESSure2 above
:MODE?                               return 1 if calibration edit enabled
:MODE <access code>                 Request calibration edit
DISP
  :ENABLE ON|OFF|1|0                 Turns Front Panel Display On/Off
  TEXT <string>                     Displays Message on Front Panel
  :BGRaph<number>                   Sets Bar Graph Maximum
OUTPut
  :STATE ON|OFF|1|0 off=MEASure, on=CONTrol
  :STATE?                            Returns 0=Measure or 1=Control
  :MODE MEASure|CONTrol|VENT         Sets Mode
  :MODE?                             Returns Mode String
PROGRAM
  :CATalog?                          Returns List of Defined Programs
  [SElected]
    :DEFine<program block>           Define Program
                                        Press1, Toler1, Dwell1, Max1, Press2,
                                        Toler2,...
    :DEFine?                          Read Program Definition
  :DElete
    [:SElected]                     Deletes Current Program
    :ALL                               Deletes All Programs
  :NAME <program name>               Select Current Program
  :STATE RUN|PAUSE|STOP|CONTinue Set Program State
  :STATE?                             Read Program State
  :CONFigure
    :RECall                           Restore Saved Configuration
    :SAVE                              Save Current Configuration
SENSE
  [:PRESSure]
  [:RESolution] <number>             Set Pressure Display Resolution
    :AUTO<boolean>|ONCE              Return to Default Resolution
  :MODE?                               Returns ABSOLUTE or GAUGE
  :MODE ABSolute|GAUGE               Turns On or Off Simulated Absolute
  :RANGE
    [:UPPer]?                         Returns Calibrator Full Scale Value in Units
    :LOWer?                           Returns Lowest Calibrated Value
  :REFerence
    [:HEIGHt] <number>                Set Gas Head Height
    :MEDium N2|AIR                     Set Gas Medium
[SOURce]
  [:PRESSure]
  [:LEVel]
    [:IMMediate]
      [:AMPLitude] <number>           Sets Pressure Setpoint
      [:AMPLitude]?                   Read Pressure Setpoint
  :MODE FIXed|LIST                   Set Source Parameter Set
  :TOLerance<number>                 Specifies Output Tolerance
  :SLEW <number>                     Set Slew Rate
  :CONTrol <number>                  Set Control Band
    :OFF <number>                     Set control off band

```

:ON <number>	Set control on band
:OVERshoot ON OFF 1 0	Set Overshoot Mode
LIST	
:PRESSure<number> [,<number>]	Set List of Pressure Values
:POINTs?	Returns Number of Points Defined
:DWELL<number>[,<number>]	Specifies Dwell Times
:POINTs?	Returns Number of Dwell Times
:TOLerance<number>[,<number>]	Specifies Tolerances
:POINTs?	Returns Number of Tolerances
:DIRection UP DOWN	Direction to Go Through List
:COUNT<number>	Number of Times to Go Through List
STATus	
:OPERation	
[:EVENT]?	Read/Clear Operation Event Register
:CONDition?	Read Operation Condition Register
:ENABLE<number>	Set Operation Enable Mask
:QUEStionable	
[:EVENT]?	Read/Clear Questionable Event Register
:CONDition?	Read Questionable Condition Register
:ENABLE <number>	Set Questionable Enable Mask
:PRESet	Reset Condition Flags
SYSTem	
:DATE <year>,<month>,<day>	Set System Date
:ERRor?	Returns <error#,"descr;info"> Or 0,"No Error"
:KLOCK ON OFF 1 0	Lock Keyboard
:TIME <hour>,<minute>,<second>	Set System Time
:VERSion?	Returns 1991.0
:LANGuage "6000" "SCPI" "500"	Set Interface Protocol to 6000 or SCPI, or Druck DPI-500
	Reset System
TEST	
:ELECTronic?	Perform Electronic Self-Test
:PNEumatic	Start Pneumatic Self-Test
:PNEumatic?	Return Status of Pneumatic Self-Test
STOP	Abort Pneumatic Self-Test
UNIT	
:DEFine<n> <name>,<number>	Define a Unit
:LENGth MM IN	Set Length Units for Head Height
[:PRESSure] <unit name>	Set Pressure Units. Valid unit names are KPA, BAR, PSI, KG/CM2, MMHG0C, CMHG0C, INHG0C, INHG60F CMH204C, INH2020C, INH2025C, %FS FT, M, KNOT, KM/HR, MPA, PA

Example SCPI Commands

To request the current pressure reading, all of the following commands are equivalent:

```

:MEASURE:PRESSURE?
:measure:pressure?
:MeAsUrE:pReSsUrE?
:meas:pres?
:measure?
:meas?
MEAS?

```

To set the control pressure set-point to 50, all of the following commands are equivalent:

```

SOURCE:PRESSURE:LEVEL:IMMEDIATE:AMPLITUDE 50
SOUR:PRES:LEV:IMM:AMPL 50.0
PRESSURE +50
PRES 50

```

To zero the unit via the remote interface use the following sequence:

CAL:ZERO:INIT	Enter Zero Mode
CAL:ZERO:INIT?	Read Status (Mode, Pressure, Temperature, Reference) and Wait Until Stable.
CAL:ZERO:RUN	Start Zero Adjust Sequence
STAT:OPER:COND?	Wait Until Complete (Bit 0 = 0)

SCPI Status Registers

Three types of status registers are available: Condition, Event, and Enable.

Condition registers always show the current status of the instrument. Bits may turn on and back off between reads. The status read is the status of instrument at the moment of the read. Condition registers include:

*STB?	Status Byte Register
*ESR?	Standard Event Status Register
STAT:OPER:COND?	Operation Status Condition Register
STAT:QUES:COND?	Questionable Status Condition Register

Event registers do not show the current state but flag the bits in the condition registers that have changed since the last time the event register was read. When an event register is read it is reset to zero.

STAT:OPER:EVENT?	Operation Status Event Register
STAT:QUES:EVENT?	Questionable Status Event Register

Enable registers are set by the user to create summary bits. If the user sets a bit in the enable register, when the instrument sets the corresponding bit in the event register a summary bit in the Status Byte Register is set.

*ESE	
STAT:OPER:ENAB	
STAT:QUES:ENAB	

The Service Request Enable Register (*SRE) is used to generate service requests on the IEEE-488 bus. If a user sets a bit in this register, when the instruments sets the corresponding bit in the Status Byte Register (*STB) a service request is generated.

*SRE	
------	--

Status Byte Register (STB), Service Request Enable Register (SRE)

Bit 7	Operation status summary. Set when an event enabled in OPER:ENABLE occurs.
Bit 6	Service request. Set when an event enabled in SRE occurs. (This bit is not used in SRE.)
Bit 5	EBS - Event status bit. Set when an event enabled in ESE occurs.
Bit 4	MAV - Message available. Set when a response is ready to be sent.
Bit 3	Questionable status summary. Set when an event enabled in QUES:ENABLE occurs.
Bit 2	Error/event queue not empty.
Bit 1	Reserved. 0.
Bit 0	Reserved. 0.

Standard Event Status Register (ESR), Standard Event Status Enable Register (ESE)

Bit 7	Power-on. Set at power-up.
Bit 6	Reserved 0.
Bit 5	Command error. Error in command syntax.
Bit 4	Execution error. Error in command execution.
Bit 3	Device dependent error. Device error independent of commands.
Bit 2	Query error. Output queue empty when request received.
Bit 1	Reserved. 0.
Bit 0	Operation complete. Set for *OPC command.

Operation Status (OPER:EVENT, OPER:CONDITION, OPER:ENABLE)

Bit 0	Calibrating. Currently performing a calibration.
Bit 1	Settling. Control setpoint has not been reached. Pressure tolerance set by SOUR:PRES:TOL
Bit 2	Reserved. 0.
Bit 3	Reserved. 0.
Bit 4	Measuring. The instrument is actively measuring.
Bit 5	Reserved. 0.
Bit 7	Reserved. 0.
Bit 8	Self-test in progress.
Bit 9	Reserved.
Bit 10	Reserved. 0.
Bit 11	Reserved. 0.
Bit 12	Reserved. 0.
Bit 13	Reserved. 0.
Bit 14	Program running.
Bit 15	Reserved. 0.

Questionable Status (QUES:EVENT, QUES:CONDITION, QUES:ENABLE)

Bit 0	Reserved.
Bit 1	Reserved. 0.
Bit 2	Time is questionable. Set when the clock has not been set.
Bit 3	Temperature is questionable. Sets when oven temperature is not within range.
Bit 4	Reserved. 0.
Bit 5	Reserved. 0.
Bit 6	Reserved. 0.
Bit 7	Calibration is questionable. Set when the unit has not been calibrated.
Bit 8	Pressure is questionable. Set when the pressure is overranged.
Bit 9	Reserved. 0.
Bit 10	Reserved. 0.
Bit 11	Reserved. 0.
Bit 12	Reserved. 0.
Bit 13	Reserved. 0.
Bit 14	Command warning. Set whenever a command ignores a parameter.
Bit 15	Reserved. 0.

6005 Interface Panel Emulation

The RUSKA 7250 may be configured to emulate the IEEE-488 command set of the RUSKA Single Channel Interface Panel (Models 6005-701 and 6005-761). See the Interface Panel User's Manual for a description of the protocol. The RUSKA 7250 emulation has the following differences:

1. The Calibrator is always in Remote mode (Byte 1, Bit 1).
2. All TI strip outputs must be written as OFF.
3. No special functions are implemented.
4. Any message written to the Calibrator that starts with a colon as the first character is interpreted as a SCPI command.

To change from SCPI to Interface Panel Emulation via the remote interface, send the following message:

:SYSTem:LANGuage "6000".

To change from Interface Panel Emulation to SCPI via the remote interface send the following message:

:SYSTem:LANGuage "SCPI".

Serial Operation

The RS-232 port accepts the same SCPI commands as the IEEE-488 port. The commands can be terminated by a carriage return (hexadecimal 0D) or a line feed (hexadecimal 0A). The responses are always terminated by a carriage return followed by a line feed.

The serial port also supports XON/XOFF. When the XOFF (hexadecimal 13) command is received, the RUSKA 7250 will stop transmitting. Transmission is restarted when the XON (hexadecimal 11) command is received.

When only one unit is attached, the Control-C (hexadecimal 03) command will clear the transmit and receive buffers and disable addressing. When addressing is disabled, the unit will respond to commands without being addressed.

Druck DPI-510 Emulation Command Summary

Supported Commands

B <value>	Set Tare amount
C0	Go to MEASURE mode.
C1	Go to CONTROL mode.
D0, D2	Transmit Pressure Reading
D1	Transmit Set-point
Fxx	<i>(Ignored)</i>
I0	Disable SRQ
I1	SRQ on In Limit
I2	SRQ on Error
I3	SRQ on In Limit and Error
I4	SRQ on End of Conversion
I5	SRQ on Error and End of Conversion
I6	SRQ on In Limit and End of Conversion
I7	SRQ on In Limit, Error and End of Conversion
J0,J1,J2	Set Pre-programmed rate.
M	Unlock keyboard
N0,N1,N2,N3,N4	Set talk mode notation
O1	Zero
P<value>	Set pressure Set-point

R0	Unlock keyboard
R1,R2	Lock keyboard
S0,S1,S2,S3	Set pre-programmed units
T0	Turn off Tare mode
T1	Turn on tare mode to value set to B (B must be set first)
U1 to U23	Set S4 units (if S4 is selected this will change current units immediately)
V<value>	Set slew rate (sets low overshoot mode)
W<value>	Set In Limit wait time
/0 to /11	Set set-point as fraction of P value
*0 to *11	Set pre-programmed set-point
@0	Disable error reporting
@1	Enable error reporting

Response Formats

N0	<Pressure or Setpoint><REM LOC>RnSnDn[@nn]
N1	<Pressure or Setpoint>[@nn]
N2	<REM LOC>RnSnDnCnInFn
N3	<In Limit Status>[@nn]
N4	@nEnJnVnnnnUaaaa

Note

Secondary addressing is not supported.

Reset Conditions

N0 D0 F0 I0 @1 R0 S0 W002

Notes

Format

Upper and lower case are equivalent. Spaces and equal signs are ignored before numeric values. Spaces, commas, semi-colons, and colons are ignored before and after commands.

Zeroing

The RUSKA sensor takes longer to zero. This time can be set from the front panel. The default is 5 seconds but this may need to be increased especially for absolute units. When the zero command is received the zeroing valve is opened, the system waits the zero delay time and then the sensor is zeroed.

Rate

If the rate is positive it will be used at the maximum rate with the overshoot set to low. If the rate is zero then the maximum rate will be used with the overshoot set to low. If the rate is negative the maximum rate will be used with the overshoot set to normal.

Units

Unit Number	Unit Name	RUSKA display units
1	Pa	kPa
2	kPa	kPa
3	Mpa	kPa
4	mbar	bar
5	bar	bar
6	kg/cm2	kg/cm ²
7	kg/m2	kg/cm ²
8	mmHg	mmHg 0°C
9	cmHg	cmHg 0°C
10	mHg	cmHg 0°C
11	mmH2O	cmH ₂ O 4°C
12	cmH2O	cmH ₂ O 4°C
13	mH2O	cmH ₂ O 4°C
14	torr	mmHg 0°C
15	atm	bar
16	psi	psi
17	lb/ft2	psi
18	inHg	inHg 0°C
19	"H2O04	inH ₂ O 4°C
20	'H2O04	InH ₂ O 4°C
21	SPECL	User Defined 1
22	"H2O20	inH ₂ O 20°C
23	'H2O20	inH ₂ O 20°C

Sample Programs

Sample Program 1 - 7250 GPIB (IEEE-488)

Controls Pressure to 20.000 %FS

```

/*-----*/
/*      Sample Program 1 - 7250 GPIB (IEEE-488)      */
/*-----*/
/*      Controls pressure to 20.000 %FS              */
/*-----*/

#include <stdio.h>
#include <stdlib.h>
#include <string.h>
#include <conio.h>

#include "decl.h"

/*-----*/

int  device;          /* GPIB Device descriptor */
char buffer[256];    /* buffer for input/output strings */
double pressure;    /* Pressure read from unit */
int  status;        /* Status register from unit */

int  check_errors (void);
void write_7000 (char *s);
void request_7000 (char *s);
/*-----*/

void main (void)
{
    char *p;

    /*-----*/
    /* Initialize GPIB Interface */
    /*-----*/
    device = ibdev (0,          /* First GPIB Board */

```

```

        4,                /* GPIB Address of 7010 */
        NO_SAD,          /* No secondary addressing */
        T1s,            /* 1 Second Timeout */
        0,              /* No automatic EOI for transmit */
        REOS+LF);      /* Terminate read on Line Feed */
if (ibsta & ERR)
{ printf ("GPIB Driver not installed.\n");
  return;
}

/*-----*/
/* Initialize 7250 Interface */
/*-----*/
/*      UNIT %FS          Set units to percent of full scale */
/*      PRES 20.0         Set control setpoint to 20 %FS */
/*      PRES:TOL 0.001   Set control tolerance to 0.001 %FS */
/*      OUTP:MODE CONTROL Enter control mode */
/*-----*/
write_7000 ("UNIT %FS;:PRES 20.0;:TOL 0.001;:OUTP:MODE CONTROL\n");

if (check_errors ( ))
{ ibonl (device, 0);
  return;
}

/*-----*/
/* Read pressure status until setpoint is reached. */
/*-----*/
/*      MEAS?             Read pressure */
/*      STAT:OPER:COND?   Read status setpoint */
/*-----*/
while (!kbhit ( ))
{ request_7000 ("MEAS?;:STAT:OPER:COND?\n");
  pressure = strtod (buffer, &p);
  status   = atoi (++p);

  if (check_errors ( ))
    continue;

  if (status & 0x10)
    printf ("Pressure = %9.3lf\n", pressure);
  if ((status & 2) == 0)
    break;
}

/*-----*/
/* Reset 7250 to Measure mode */
/*-----*/
/*      OUTP:MODE MEASURE Enter Measure mode */
/*-----*/
write_7000 ("OUTP:MODE MEASURE\n");

check_errors ( );

/*-----*/
/* Reset GPIB Interface */
/*-----*/
ibonl (device, 0);
}

/*-----*/
/* check_errors : display all GPIB and 7250 error messages */
/*               return TRUE if any errors were found */
/*-----*/
int check_errors (void)
{
  unsigned char status7;
  int retval;

```

```

/*-----*/
/* Check for GPIB Interface Errors */
/*-----*/
if (ibsta & ERR)
  { printf ("GPIB Status=%4X Error=%d\n");
    return 1;
  }

/*-----*/
/* Check for 7250 Errors */
/*-----*/
retval = 0;
while (!kbhit ( ))
  { ibrsp (device, &status7);          /* Serial poll */
    if ((status7 & 4) == 0)          /* Check error bit */
      break;
    retval = 1;
    request_7000 ("SYST:ERR?\n");    /* Get error message */
    printf (buffer);
  }
return retval;
}
/*-----*/
/* write_7000 : write a command to the 7250 */
/*-----*/
void write_7000 (char *s)
{
  ibwrt (device, s, strlen (s));
}
/*-----*/
/* request_7000 : write a query command and read the response */
/*-----*/
void request_7000 (char *s)
{
  ibwrt (device, s, strlen (s));
  ibrd (device, buffer, sizeof (buffer));
}
/*-----*/

```

Sample Program 2 - 7250 GPIB (IEEE-488)

Zero Sequence

```

/*-----*/
/*      Sample Program 2 - 7250 GPIB (IEEE-488)      */
/*-----*/
/*      Zero Sequence      */
/*-----*/
#include <stdio.h>
#include <stdlib.h>
#include <string.h>
#include <conio.h>

#include "decl.h"

/*-----*/

int   device;          /* GPIB Device descriptor */
char  buffer[256];     /* buffer for input/output strings */
double pressure;      /* Pressure read from unit */
int   status;         /* Status register from unit */

int   check_errors (void);
int   zero (void);
void  write_7000 (char *s);
void  request_7000 (char *s);
/*-----*/

void main (void)
{
  char *p;

  /*-----*/
  /* Initialize GPIB Interface */
  /*-----*/
}

```

```

device = ibdev (0,          /* First GPIB Board */
               4,          /* GPIB Address of 7250 */
               NO_SAD,     /* No secondary addressing */
               T1s,        /* 1 Second Timeout */
               0,          /* No automatic EOI for transmit */
               REOS+LF);   /* Terminate read on Line Feed */

if (ibsta & ERR)
{ cprintf ("GPIB Driver not installed.\n");
  return;
}

/*-----*/
/* Zero 7010 */
/*-----*/
if (!zero ( ))
{ ibonl (device, 0);
  return;
}
/*-----*/
/* Reset GPIB Interface */
/*-----*/
ibonl (device, 0);
}

/*-----*/
/* Zero : perform zero adjust of 7250 */
/*-----*/
int zero (void)
{
  int cstat, pstat, tstat, rstat;

  clrscr ( );
  cprintf ("Zeroing");

  gotoxy (1, 5); cprintf ("Pressure Reading");
  gotoxy (1, 6); cprintf ("Sensor Temperature");
  gotoxy (1, 7); cprintf ("Reference Pressure");

  /*-----*/
  /* Enter Zero Mode */
  /* CAL:ZERO:INIT */
  /*-----*/
  write_7000 ("CAL:ZERO:INIT\n");

  /*-----*/
  /* Wait for calibration values to be within limits */
  /* CAL:ZERO:INIT? */
  /*-----*/
  do
  { if (kbhit ( ))
    { getch ( );
      break;
    }

    request_7000 ("CAL:ZERO:INIT?\n");
    sscanf (buffer, "%d,%d,%d,%d", &cstat, &pstat, &tstat, &rstat);

    if (check_errors ( ))
      return 0;

    gotoxy (20, 5);
    if (pstat == 0) cprintf ("Stable ");
    else if (pstat < 0) cprintf ("Out of Range ");
    else if (pstat > 0) cprintf ("Unstable (%2d seconds)", pstat);

    gotoxy (20, 6);
    if (tstat == 0) cprintf ("Stable");
    else if (tstat < 0) cprintf ("Out of Range");
    else if (tstat > 0) cprintf ("Unstable (%2d minutes)", tstat);

```



```

        gotoxy (20, 7);
        if (rstat == 0)    cprintf ("Stable");
        else if (rstat < 0) cprintf ("Out of Range");
        else if (rstat > 0) cprintf ("Unstable (%2d seconds)", rstat);
    }
    while (pstat != 0 || tstat != 0 || rstat != 0);

    /*-----*/
    /* Start Zero Adjust */
    /*   CAL:ZERO:RUN   */
    /*-----*/
    write_7000 ("CAL:ZERO:RUN\n");

    /*-----*/
    /* Wait for zero to complete */
    /*   STAT:OPER:COND?   */
    /*-----*/
    do
        { request_7000 ("STAT:OPER:COND?\n");
          sscanf (buffer, "%d", &status);

          if (check_errors ( ))
              return 0;

          gotoxy (1, 9);
          cprintf ("Zeroing");
        }
    while ((status & 1) != 0);

    gotoxy (1, 9);
    cprintf ("Zero Complete");
    return 1;
}

/*-----*/
/* check_errors : display all GPIB and 7250 error messages          */
/*               return TRUE if any errors were found              */
/*-----*/

int check_errors (void)
{
    unsigned char status7;
    int retval;

    /*-----*/
    /* Check for GPIB Interface Errors */
    /*-----*/
    if (ibsta & ERR)
        { cprintf ("GPIB Status=%4X Error=%d\r\n", ibsta, iberr);
          return 1;
        }

    /*-----*/
    /* Check for 7250 Errors */
    /*-----*/
    retval = 0;
    while (!kbhit ( ))
        { ibrsp (device, &status7);          /* Serial poll */
          if ((status7 & 4) == 0)            /* Check error bit */
              break;
          retval = 1;
          request_7000 ("SYST:ERR?\n");     /* Get error message */
          cprintf (buffer);
        }
    return retval;
}

/*-----*/
/* write_7000 : write a command to the 7250                        */
/*-----*/
void write_7000 (char *s)
{

```

```

        ibwrt (device, s, strlen (s));
    }
    /*-----*/
    /* request_7000 : write a query command and read the response      */
    /*-----*/
    void request_7000 (char *s)
    {
        ibwrt (device, s, strlen (s));
        ibrd (device, buffer, sizeof (buffer));
    }
    /*-----*/

```

Sample Program 3 - 7250 Serial (RS-232)

Controls Pressure to 20.000 %FS

```

/*-----*/
/*      Sample Program 3 - 7250 Serial (RS-232)                      */
/*-----*/
/*      Controls pressure to 20.000 %FS                             */
/*-----*/
#include <stdio.h>
#include <stdlib.h>
#include <conio.h>
#include <dos.h>
#include <time.h>

#define TRUE 1
#define FALSE 0

#define TIMEOUT (CLK_TCK * 5)    /* 5 second timeout */
#define XON 0x11
#define XOFF 0x13
#define CLEAR 0x03
#define DLE 0x10
#define QUEUE_SIZE 1024

char  buffer[QUEUE_SIZE];        /* buffer for input/output strings */
double pressure;                /* Pressure read from unit */
int    status;                  /* Status register from unit */

int  address;
int  portbase;
int  intnum;
volatile int  transmit_enabled = TRUE;
char inqueue[QUEUE_SIZE];
int  inq_in;
int  inq_out;
void interrupt (*old_vector) ( );

int  check_errors (void);
void serial_initialize (void);
void write_7000_serial (char *s);
void serial_close (void);
int  request_7000_serial (char *s);
void serial_write (char ch);

/*-----*/

void main (void)
{
    char *p;

    /*-----*/
    /* Initialize Serial Interface */
    /*-----*/
    address = 4;
    serial_initialize ( );

    /*-----*/
    /* Initialize 7250 Interface */
    /*-----*/
    /*      UNIT %FS           Set units to percent of full scale */
    /*      PRES 20.0         Set control setpoint to 20 %FS      */
    /*-----*/

```

```

/*      PRES:TOL 0.001      Set control tolerance to 0.001 %FS */
/*      OUP:MODE CONTROL  Enter control mode                    */
/*-----*/
write_7000_serial ("UNIT %FS;:PRES 20.0;TOL 0.001;:OUP:MODE CONTROL\n");

if (check_errors ( ))
    { serial_close ( );
      return;
    }

/*-----*/
/* Read pressure status until setpoint is reached. */
/*-----*/
/*      MEAS?              Read pressure                    */
/*      STAT:OPER:COND?    Read status setpoint            */
/*-----*/
while (!kbhit ( ))
    { if (!request_7000_serial ("MEAS?;:STAT:OPER:COND?\n"))
      { printf ("Timeout\n");
        continue;
      }
      pressure = strtod (buffer, &p);
      status   = atoi (++p);

      if (check_errors ( ))
          continue;

      if (status & 0x10)
          printf ("Pressure = %9.3lf\n", pressure);
      if ((status & 2) == 0)
          break;
    }

/*-----*/
/* Reset 7250 to Measure mode                    */
/*-----*/
/*      OUP:MODE MEASURE  Enter Measure mode */
/*-----*/
write_7000_serial ("OUP:MODE MEASURE\n");
check_errors ( );

/*-----*/
/* Reset Serial Interface */
/*-----*/
serial_close ( );
}

/*-----*/
/* check_errors : display all 7250 error messages */
/*      return TRUE if any errors were found      */
/*-----*/
int check_errors (void)
{
    unsigned char status7;
    int retval;

    /*-----*/
    /* Check for 7250 Errors */
    /*-----*/
    retval = 0;
    while (!kbhit ( ))
        { if (!request_7000_serial ("*STB?\n"))
          { printf ("Timeout\n");
            return TRUE;
          }
          status7 = atoi (buffer);
          if ((status7 & 4) == 0)                /* Check error bit */
              break;
          retval = 1;
          request_7000_serial ("SYST:ERR?\n");    /* Get error message */
        }
    printf (buffer);
    }
    return retval;
}

```

```

}
/*-----*/
/* serial_int : receive interrupt for serial port */
/*-----*/
void interrupt serial_int ( )
{
    char ch;

    if ((inportb (portbase + 2) & 0x07) == 0x04)
    { ch = inportb (portbase);
      if (ch == XON)
        transmit_enabled = TRUE;
      else if (ch == XOFF)
        transmit_enabled = FALSE;
      else
        { inqueue[inq_in++] = ch;
          if (inq_in == QUEUE_SIZE)
            inq_in = 0;
        }
    }
    outportb (0x20, 0x20);
}
/*-----*/
/* serial_initialize : initialize serial port */
/*-----*/
void serial_initialize ( )
{
    char msg[10];
    int divisor;
    unsigned v;

    portbase = 0x3F8;          /* COM1 = 0x3F8, COM2 = 0x2F8 */
    intnum = 4;               /* COM1 = 4, COM2 = 3 */
    outportb (portbase + 3, 0x80);
    outportb (portbase + 1, 0);
    outportb (portbase, 0x0C); /* 9600 Baud */
    outportb (portbase + 3, 3); /* 8 Databits, No Parity, 1 Stopbit */
}

old_vector = getvect (intnum + 8); /* Save old interrupt vector */
setvect (intnum + 8, serial_int); /* Set new interrupt vector */

v = inportb (0x21);          /* Enable interrupt */
v &= ~(1 << intnum);
outportb (0x21, v);

outportb (portbase + 1, 0x01); /* Enable receive interrupt */
outportb (portbase + 4, 0x0B); /* Enable Interrupt, DTR, RTS */

serial_write (CLEAR);
}
/*-----*/
/* serial_close : turn off serial receive interrupt */
/*-----*/
void serial_close ( )
{
    unsigned v;

    outportb (portbase + 1, 0);
    outportb (portbase + 4, 0);
    v = inportb (0x21);
    v |= 1 << intnum;
    outportb (0x21, v);
    setvect (intnum + 8, old_vector);
}
/*-----*/
/* serial_write : write a single character to serial port */
/*-----*/
void serial_write (char ch)
{
    while (!transmit_enabled)
        ;
    while ((inportb (portbase + 5) & 0x20) == 0)

```

```

        ;
        outportb (portbase, ch);
    }
    /*-----*/
    /* write_7000_serial : write a string to the correct 7250 */
    /*-----*/
void write_7000_serial (char *s)
{
    if (address == -1)
        serial_write (CLEAR);          /* Disable Addressing */
    else
        { serial_write (DLE);          /* Enable Addressing */
          serial_write (address + 0x20); /* Address */
        }
    while (*s)                          /* Write string */
        serial_write (*s++);
}
/*-----*/
/* request_7000_serial : write a command and read the response */
/*-----*/
int request_7000_serial (char *s)
{
    int i;
    char ch;
    clock_t start, current;

    write_7000_serial (s);              /* Write Command */
    i = 0;
    while (i < QUEUE_SIZE - 1)
        { start = clock ( );
          while (inq_in == inq_out)      /* Wait for a character */
              { current = clock ( );
                if (current < start)
                    current += CLK_TCK * 86400;
                if (current - start > TIMEOUT) /* Check for timeout */
                    { buffer[i] = 0;
                      return FALSE;
                    }
              }
          ch = inqueue[inq_out++];        /* Put character in buffer */
          if (inq_out == QUEUE_SIZE)
              inq_out = 0;
          if (ch == 0x0A)                 /* Line Feed? - End of response */
              { buffer[i] = 0;
                return TRUE;
              }
          else
              buffer[i++] = ch;
        }
    buffer[QUEUE_SIZE - 1] = 0;          /* Buffer full */
    return FALSE;
}
/*-----*/

```

Sample Program 4 - QBASIC

Example for 7250

```

REM $INCLUDE: 'C:\GPIB-PC\QBDECL.BAS'
DIM READING AS STRING*30
CALL IBDEV(0,4,0,12,1,&H40A,R7010%)
CALL IBCLR(R7010%)
CALL IBWRT(R7010%,"MEAS?" + chr$(&H0A))
CALL IBRD(R7010%,READING$)
PRINT READING$
CALL IBONL(R7010%,0)
END

```

Note

EOM & EOS are linefeed.

Chapter 6

Maintenance

Introduction

Very little maintenance is required for the RUSKA 7250. This section of the manual discusses suggested maintenance procedures.

Warning

To prevent possible electrical shock, fire, or personal injury:

- **Disconnect the mains power cord before you remove the Product covers.**
- **Use only specified replacement parts.**
- **Have an approved technician repair the Product.**
- **Do not operate the Product with covers removed or the case open. Hazardous voltage exposure is possible.**

Observing the Software Version Number

Follow the steps below to observe the RUSKA 7250's software version number.

1. If necessary, press PREVIOUS several times to return the display to the Main Menu.
2. Select Menu | Setup | System. The software version number will appear on the screen.
3. Press PREVIOUS to return to the previous screen.

Preventive Maintenance

Although the RUSKA 7250 is designed to be nearly maintenance free, occasional preventive maintenance is required to keep the Calibrator's performance optimal.

Initiating the RUSKA 7250's Self Test

To test the Calibrator's hardware, software, and pneumatics, follow the steps below.

1. If necessary, press PREVIOUS several times to return the display to the Main Menu.
2. Select Menu | Test | Self

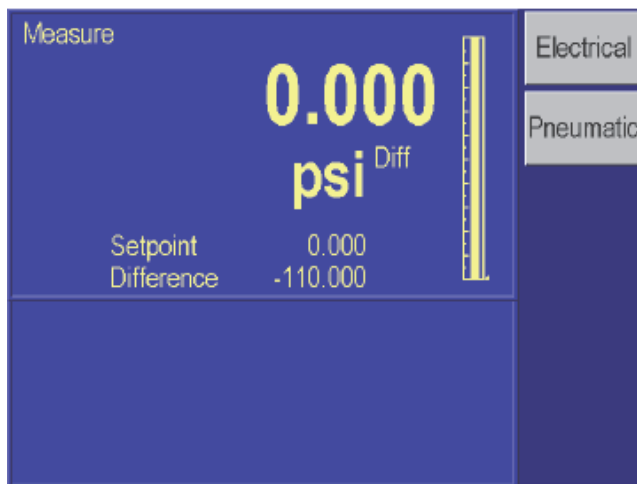

Figure 6-1. Menu | Test | Self - Menu

gkn041.bmp

3. Press Electrical [F1]. The electronics self test will run and display the results.
4. Press PREVIOUS to return to the previous screen.

The electronics test runs eight sets of tests on various parts of the electronic modules. Table 6-1 describes these tests and the possible actions needed if a test fails. The pneumatics test runs nine tests on the pneumatics module.

Table 6-1. Electronics Self Test

Test	Description	Action on failure
Processor	Tests the processor chip	Replace processor board.
Clock	Tests the real time clock	Replace processor board.
Control	Tests operation of the control board	Replace control PCB

Removing the Calibrator's Cover

The RUSKA 7250 should be kept clean and completely assembled at all times. Operating the Calibrator without its cover affects the Calibrator's thermal gradients and therefore may reduce precision. If it becomes necessary to remove the RUSKA 7250's cover, follow the instructions below.

⚠️⚠️ Warning

The RUSKA 7250 should only be opened by qualified electrical/mechanical service technicians. Lethal voltages are present and exposed in the power supply and display.

1. Turn off the RUSKA 7250 and disconnect the power cord from the Calibrator.
2. Locate and unscrew the four screws that secure the cover to the back panel.
3. Place your hands near the middle of the cover and slide the cover towards the Calibrator's back panel.
4. Lift up on the cover. With the cover removed, use typical electronic cleaning tools to remove any accumulated dust from inside the instrument.
5. Replace the cover before resuming operation.

Moisture Filter

The Bourdon tube sensor is hygroscopic. An external desiccant filter prevents introduction of moisture and is strongly recommended for high humidity areas. The filter should be replaced annually. The moisture filter is used with the reference port only (absolute only instruments do not need a moisture filter).

Particle Filters

Refer to Appendix A for air supply quality requirements. During normal operation, the RUSKA 7250 transfers gas both into and out of the device under test (DUT). When necessary, the user is expected to use and maintain an in-line disposable particle filter to protect the Calibrator's pneumatics from any contamination that may exist in the DUT.

Vacuum Pumps

Periodic checks of the user's vacuum pumps for oil levels. It is very highly recommended that a power-down vacuum venting valve is installed onto the vacuum pumps to ensure minimal chances of oil contamination from the vacuum sources. These are normally open solenoid valves that are powered through the vacuum pump power switch. When the vacuum pump is turned on, the solenoid valve is energized and closes allowing the pump to operate normally. When the pump is turned off, power is removed from the solenoid and the vacuum is vented to atmosphere. Periodic changing of vacuum pump oil as recommended by the vacuum pump manufacturer should also be done.

Processor Battery

The processor board uses a lithium battery to maintain time and date information. This battery has a varying life. If the instrument is left on 24 hours a day, it may last 5 to 10 years. If the instrument is stored, it may only last one year. Annual replacement is recommended. To replace the battery:

1. Turn off power and remove the instrument cover. See above, Removing the Calibrator's Cover.
2. Remove the processor card by removing the screw and the bracket that locks the display cable in place and gently rock the card upward.
3. Holding the processor card, remove the battery (the round silver object), by carefully pulling on the battery.
4. Plug in a new battery (part number 4-725).
5. Reinstall the processor card, the bracket that locks the display cable in place and the screw. Replace the instrument cover.
6. The time and date may have to be re-entered. See Chapter 4, Menu, Menu | Setup - System.

Calibration

To keep the RUSKA 7250 operating within its specified precision, the calibration procedure described below should be performed once every year. If a higher level of overall performance is desired, the user can calibrate more frequently.

Note

The calibration procedure automatically generates coefficients that are stored in memory on the RUSKA 7250. If these constants are "lost" for any reason, the calibration procedure must be performed, regardless of the last calibration date. If the calibration coefficients have been recorded, they may be restored to the RUSKA 7250 at any time by "editing the coefficients." (See below, Barometric Reference Calibration - Simulated Absolute.)

Calibration Instructions

To calibrate the RUSKA 7250, the user connects a calibration standard such as the RUSKA Instrument Model 2465 (or 2470 for high pressure ranges) Gas Piston Gauge to the Calibrator's test port, then follow the multi-step calibration procedure on the Calibrator's display. The standard RUSKA 7250 requires a positive pressure calibration. A vacuum (negative gauge) option is available and requires special calibration; see this Chapter, Vacuum (Negative Gauge) Calibrations. No disassembly is required and there are no potentiometers to tune.

Note

The uncertainty of the final calibration must include the uncertainty of the pressure standard being used.

Preparation

1. Verify that the Calibrator's Reference Port is open to atmosphere for gauge calibrations and that the calibration standard is connected to the Test Port.
2. For Calibrators with pressure ranges greater than 100 psi (690 kPa) verify that the supply pressure port is plugged, or a supply pressure is connected to the supply port and adjusted to 110% of the full scale of the Calibrator.
3. Verify that the Calibrator has been at stable environmental temperature and that the oven temperature (Menu | Display) has been stable for at least three hours.
4. Verify that the Calibrator is in Measure mode (Chapter 4).
5. If desired, change the Calibrator's units of measure (Chapter 4) to match those of the calibration standard.
6. Set the gas head to 0. Select Menu | Setup | User.
7. To access the calibration screen, select Menu | Calibration.



Figure 6-2. Menu | Calibration

gkn013.bmp

8. When you first enter the Calibration menu, the top left hand side of the display will indicate which sensor is being the viewed. The sensors coefficients are then shown below the sensor label. The first sensor that is shown is the primary measuring sensor. This is indicated by the word Primary displayed in the top of the display. To cycle through the various sensors that exist in the system, you would press the Sensor [F6] function key. Assure that you are in the screen that is labeled as Primary.
9. To begin the calibration process, press the Calibrate [F2] button. If the calibration

access code is enabled, enter it at the prompt. The first calibration screen will appear.

Note

To exit the calibration procedure before the calibration coefficients have been changed, press CANCEL any time during the procedure. Canceling restores all previous calibration values.

Step 1

1. The zero procedure will start when the reading is in-range and stable or when OK [F6] is pressed. Press OK [F6] only if the zeroing conditions are stable. The zero calibration will not be accurate if OK [F6] is pressed when conditions are unstable.
2. Wait until the zero procedure finishes. This may take several minutes. When the Calibrator completes step 1, the calibration screen will appear.



On High Pressure Models, pressure must be removed from the test port. If zeroing an Absolute unit then the Test Port must be isolated.

Step 2

1. To begin step 2, use the calibration standard to apply the various pressures that will be requested by the Calibrator. The number of pressure points required to calibrate the RUSKA 7250 will vary based on whether the Calibrator is a RUSKA 7250, 7250i or 7250xi and if it has a vacuum (negative gauge) option. The screen will display a table noting the following information;

Step	The pressure step in the calibration sequence
Apply	The pressure that the standard is to generate to the Calibrator.
Tolerance	The tolerance about the apply value that can be generated by the standard and still accepted by the Calibrator.
Actual	The actual pressure value that was generated by the standard when the point was accepted.
Adj. %FS	Depicts the amount that the Calibrator corrected its output to align to the standard. This is used as a trouble-shooting tool. If one point has a significantly higher adjustment required than other points in the calibration, this may indicate that there was an error in that specific calibration point. The operator can re-check this pressure point prior to completing and accepting the full calibration.

2. The Step 1, actual value will be highlight. This is your first pressure point in the calibration procedure.

Note

If the RUSKA 7250 has the Vacuum (Negative Gauge Option) or the Barometric reference, the first two points in the procedure will show the negative pressures that should be generated to calibrate the sensor in the negative gauge direction. You are not required to perform both the negative and the positive gauge calibrations every time the unit is calibrated. If you want to calibrate only the positive pressures, using the rotary knob move the highlighted cursor down to the first positive pressure step and generate all of the positive pressures in the procedure. When you are complete with the positive points, hit the Done key, the unit will maintain the older coefficients for the negative gauge portion of the sensor and calculate new coefficients for the positive gauge ranges. Conversely, you can calibrate just the negative gauge section if desired. However, you must complete all of the positive or negative gauge steps in the procedure to complete a valid calibration.

3. Using your calibration standard, generate the pressure shown in the Apply column. When the measured pressure stabilizes, use the Calibrator's numeric keypad to enter the actual pressure applied by the calibration standard and then press ENTER. Do not enter the measured pressure reported by the Calibrator. If necessary, use the CLEAR key to correct a mistake in the edit field. If the actual pressure applied is within the indicated tolerance, the unit will accept that point and the highlighted cursor will automatically scroll down to the next calibration step.

Note

If the actual pressure is outside of the tolerance for the requested mid-point pressure, Error—222 Data out of range will occur. Acknowledge this error by selecting OK [F6], then re-enter the actual pressure, repeating Step 2, number 1, if necessary.

Step 3

1. Generate the next pressure calibration point requested by the Calibrator. Apply this pressure using calibration standard and follow the instructions in Step 2, number 3, entering the actual pressure applied.
2. Repeat this procedure until all of the calibration steps are complete. Review the Adj. %FS field to see if one point has a significantly higher adjustment required than other points in the calibration. This may indicate that there was an error in that specific calibration point. The operator can re-check this pressure point prior to completing and accepting the full calibration. To re-enter a point, use the rotary knob and move the highlighted cursor to the actual pressure values in the step in question. Generate the requested apply pressure using the standard and enter then new actual value when stabilized.

Storing the Coefficients

Step 4

1. Calibration is complete. To exit the calibration procedure without storing the calibration coefficients in memory, press CANCEL. To store the calibration coefficients in memory, select the Done [F6] key and the Calibrator will calculate all of its new coefficients.

Note

In addition to saving the calibration coefficients to the RUSKA 7250's memory, the user is advised to separately record the calibration coefficients and store this "backup" in a safe place.

Step 5

1. Press PREVIOUS to return to the Main Menu.
2. Once the calibration procedure is complete, the user should verify several pressure readings against the pressure standard. If there are variances beyond the stated precision, then an error was probably made in generating one of the calibration pressures, and the calibration procedure should be repeated.

Vacuum (Negative Gauge) Calibrations

Vacuum mode is an available option. The following configuration should be used when calibrating in the Vacuum mode.

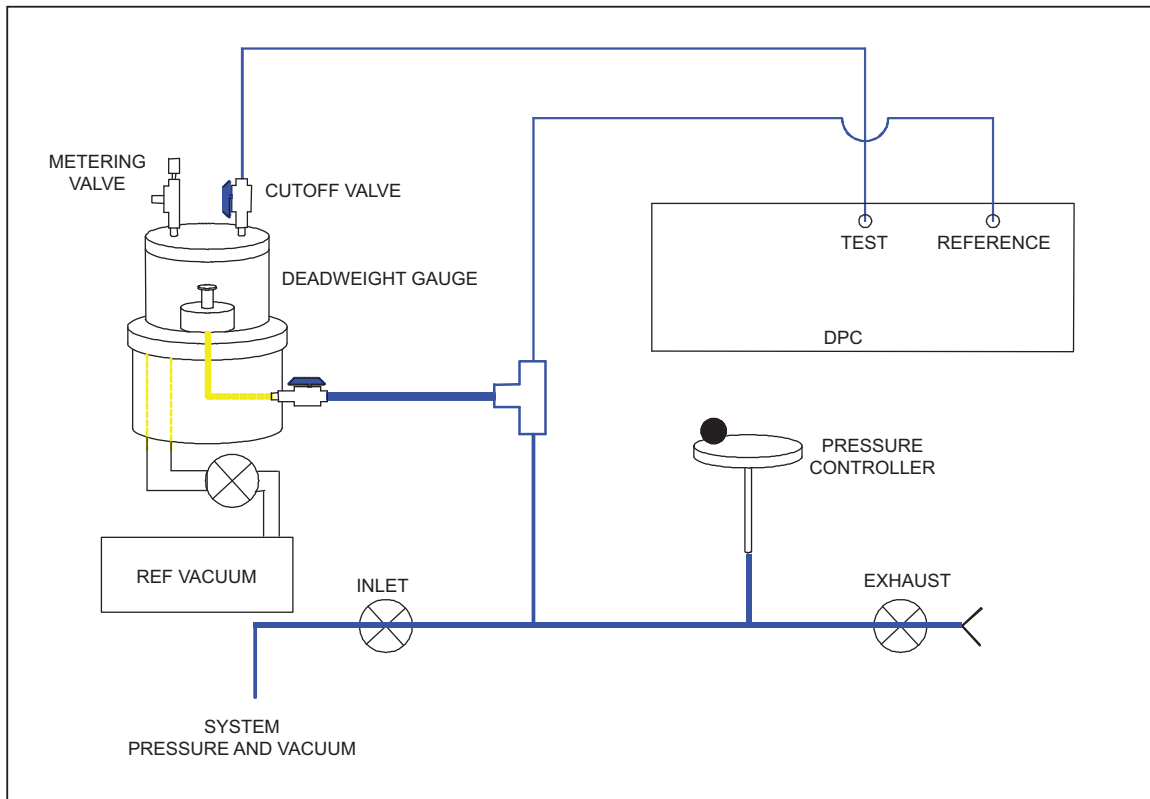

Figure 6-3. Vacuum Calibration

gkn042.eps

To calibrate in Vacuum mode with the configuration shown in Figure 6-3, the following actions should be taken. The system pressure and vacuum inlet valve should remain closed. The bottom side of the piston must be open (vented) to atmosphere and connected to the reference port of the DUT. The test port of the DUT must be connected to the bell jar with a cutoff valve to isolate it from the DUT. Additionally, there must be a cutoff valve located between the Vacuum pump and the bell jar.

Close the Cut-off valve to isolate the DUT test port from the bell jar. Open the Vacuum Pump Valve to pull a hard vacuum on the bell jar to seal the bell jar and to float the masses. Once the masses have risen in response to evacuation of the bell jar, close the reference vacuum pump cutoff valve. Use the metering valve on the bell jar to adjust (vent) the bell jar vacuum towards atmosphere until the masses begin to float. Close the metering valve as soon as the masses begin to float. Open the bell jar cutoff valve to the test port of the DUT, close the exhaust (Vent) valve, and use the pressure adjuster handwheel to adjust float position of the deadweight gauge to float the piston at mid-float position.

Barometric Reference Calibration - Simulated Absolute

A span correction can be applied to the RPT (barometric) sensor. This correction is done using the RUSKA 7250's software and can be performed without removing the RPT from the Calibrator chassis.

1. Place the Calibrator in Measure mode. Remove all pressure sources from the system.
2. Connect a pressure standard to the Reference Port of the Calibrator.
3. If desired, change the Calibrator's units of measure (see Chapter 4) to match those of the calibration standard.
4. To access the Calibration screen, from the Main Menu, select MENU | CALIBRATE.
5. Select the atmospheric sensor by pressing the Sensor [F6] key until the words Atmospheric Sensor are displayed above the calibration coefficients.
6. To begin the calibration process, press CALIBRATE. If the calibration access code is enabled, enter it at the prompt. The first Calibration screen will appear.
7. You will use the calibration standard to apply the various pressures that will be requested by the RUSKA 7250. The screen will display a table noting the following information;

Step	The pressure step in the calibration sequence.
Apply	The pressure that the standard is to generate to the Calibrator.
Actual	The actual pressure value that was generated by the standard when the point was accepted.
8. The Actual value will be highlighted. This is your first pressure point in the calibration procedure. This calibration requires the generation of two pressures within the range of 700 to 1100 mbar absolute. The selected pressures should be spaced as far apart as possible within the allowable range.
9. Generate the first pressure. Enter the actual value of the applied pressure generated by the standard and press ENTER.
10. Generate the second pressure. Enter the actual value of the applied pressure generated by the standard and press ENTER.
11. The RPT sensor is now linearly compensated. Once the calibration procedure is complete, the user should verify several pressure readings against the pressure standard. If there are variances beyond the stated precision, then an error was probably made in generating one of the calibration pressures, and the calibration procedure should be repeated.
12. Remove the pressure source from the Reference Port.

Vacuum Sensor Calibration—Optional Case Reference Sensor

A span correction can be applied to the vacuum sensor. This correction is done using the RUSKA 7250's software and can be performed without removing the vacuum sensor from the Calibrator chassis.

1. Place the Calibrator in Measure mode. Remove all pressure sources from the system.
2. The Vacuum sensors are located inside the black sensor oven assembly. Connect a pressure standard physically as close to the vacuum sensor as possible. You may wish to remove the top cover of the instrument and connect directly to the pressure ports going into the quartz sensor oven assembly. Note, on the RUSKA 7250 each sensor will have its own independent vacuum sensor.
3. If desired, change the Calibrator's units of measure (see Chapter 4) to match those of

- the calibration standard.
- To access the Calibration screen, from the Main Menu, select MENU | CALIBRATE.
 - Select the vacuum sensor by pressing the Sensor [F6] key until the words Vacuum Sensor is displayed above the calibration coefficients.
 - To begin the calibration process, press CALIBRATE. If the calibration access code is enabled, enter it at the prompt. The first Calibration screen will appear.
 - You will use the calibration standard to apply the two vacuum points on the vacuum sensor.
 - The Actual value will be highlighted. This is your first pressure point in the calibration procedure. This calibration requires the generation of two pressures within the range of 50 to 350 mtorr absolute. The selected pressures should be spaced as far apart as possible within the allowable range.
 - Generate the first pressure. Enter the actual value of the applied pressure generated by the standard and press ENTER.
 - Generate the second pressure. Enter the actual value of the applied pressure generated by the standard and press ENTER.
 - The Vacuum sensor is now linearly compensated. Once the calibration procedure is complete, the user should verify several pressure readings against the pressure standard. If there are variances beyond the stated precision, then an error was probably made in generating one of the calibration pressures, and the calibration procedure should be repeated.
 - If the instrument is fitted with two vacuum sensors, calibrate the second vacuum sensor.
 - Remove the vacuum standard from the instrument.
 - Reinstall the cover onto the Calibrator.

Editing the Calibration Coefficients

If the RUSKA 7250's memory is erased but the calibration coefficients are known, the user can restore the coefficients to the Calibrator by following the directions below.

⚠ Caution

Never randomly adjust the calibration coefficients. Only qualified personnel with valid backup data should be allowed to edit the coefficients. If the backup coefficients are questionable, perform the calibration procedure in its entirety.

- Verify that the Calibrator is in Measure mode (Chapter 4).
- Enter the Calibration screen by selecting MENU | CALIBRATE.
- When you first enter the Calibration menu, the top line of the display will indicate which sensor is being viewed. The sensors coefficients are then shown below the sensor label. The first sensor that is shown is the primary measuring sensor. This is indicated by the word Primary displayed in the top of the display. To cycle through the various sensors that exist in the system, you would press the Sensor [F6] function key. The two common sensors that would be calibrated would be the RUSKA sensor which would be labeled as Primary and if the unit has the optional Barometric Reference sensor, this would be labeled as Atmospheric Sensor.
- To edit the calibration coefficients, press the EDIT button. If the calibration access code is enabled, enter it at the prompt. The first calibration screen will appear.

Note

To exit the calibration procedure before the calibration coefficients have been changed, press CANCEL any time during the procedure. Canceling restores all previous calibration values.

5. Use the rotary knob to highlight the coefficient to be edited. The terms are coefficients of a linear regression analysis.
6. Use the numeric keypad and the ENTER key to enter a new value. To correct a mistake in the edit field, use the CLEAR key.
7. Repeat steps 4 and 5 until all coefficients are correct.

Note

In addition to saving the calibration coefficients to the RUSKA 7250's memory, separately record the calibration coefficients and store this "backup" in a safe place.

8. To exit the editing procedure without storing the calibration coefficients in memory, press CANCEL. To store the calibration coefficients in memory, select DONE [F6].
9. Press PREVIOUS to return to the Main Menu.

Once the calibration coefficients are input, the user should record several pressure readings. If there are any variances beyond the stated precision at these points, then the calibration procedure should be performed.

Zeroing

The zeroing procedure is performed to correct for system zero shift and does not require a full calibration. The most important requirement for performing a valid zeroing procedure is to guarantee that there is not a pressure differential between the sensor's test port and case reference.

If during the zeroing procedure, the message "Mechanical Zeroing Needed" appears, the sensor photocell may need to be zeroed.

The zeroing screen presents several pieces of information.

The screen will display the current status of the pressure sensor Stability and Temperature. If any of the above are unstable, then the system will delay until stability is achieved. Pressing OK [F6] will bypass this wait period.

Note

By-passing this wait period can have a negative effect on the zeroing procedure.

Gauge and Vacuum (Negative Gauge) Instruments

1. Verify that the Reference Port is open to atmosphere.
2. Enter the Calibration screen by selecting MENU | CALIBRATION.
3. Select Zero [F1]. Do NOT press the Calibrate button.



Figure 6-4. Zeroing Menu

gkn043.bmp

4. Do not disturb the instrument while zeroing is in process.
5. Wait for the zeroing procedure to finish.



Figure 6-5. Zero Set

gkn044.bmp

6. Press PREVIOUS to return to the Main Menu.

Permanent Absolute Instruments

This section details how to set up Permanent Absolute Instruments or Absolute with Evacuated Reference option.

A vacuum pump must be connected to the reference port.

A vacuum sensor is installed for measuring the case reference pressure.

1. Select the desired pressure units using the UNITS key. You can change both the unit of measure that the Calibrator is displaying, Pressure, and the unit of measure, for the vacuum sensor. It is not required to have the Calibrator displaying pressure in the same unit of measure as the vacuum sensor. To change the unit of measure for the Vacuum sensor, press the UNIT key and then the Vacuum [F2] key.
2. Enter the Calibration screen by selecting MENU | CALIBRATE.

3. Select Zero [F1]. Do NOT press the Calibrate button. When initiating the zeroing command in the Calibrator, it will cycle the internal valves allowing the external vacuum pump to pull a hard vacuum on the RUSKA sensor. It is recommended that the sensor be pulled down to a vacuum of less than 200 mTorr (preferably less than 100 mTorr) in order to obtain a proper zero. The Calibrator can be zeroed at higher vacuum levels; however, the uncertainty of vacuum sensors tend to increase at higher vacuum levels, therefore, the uncertainty in the RUSKA 7250 would also increase if zeroed at higher vacuum levels.
4. Wait for the vacuum level on the test port to stabilize.
5. Press OK [F6].
6. Do not disturb the instrument while zeroing is in process.
7. Wait for the zeroing procedure to finish.
8. Press PREVIOUS to return to the Main Menu.

RPT—Simulated Absolute Instruments

Simulated absolute Calibrators contain two sensors that require periodic zeroing. The primary sensor is zeroed according to the instructions below, Sensor Photocell Zeroing. The barometric sensor is zeroed according to the following instructions.

1. Verify that the Reference Port is open to atmosphere.
2. Enter the Calibration screen by selecting MENU | CALIBRATE.
3. Select the Atmospheric Sensor by pressing the Sensor [F6] key until the words Atmospheric Sensor are displayed above the calibration coefficients.
4. To begin the zeroing process, press ZERO. If the calibration access code is enabled, enter it at the prompt. The zeroing screen will appear.

Note

The next step requires the use of a properly calibrated standard. This zeroing process does contribute directly to the overall accuracy of the system, since the pressure applied to the sensor is a non-zero differential pressure.

5. Enter the current barometric pressure. Press ENTER.

Sensor Photocell Zeroing

If the error message “Mechanical Zeroing Needed” is displayed, the sensor photocell must be zeroed. The following steps describe this process.

⚠⚠ Warning

The RUSKA 7250 should only be opened by qualified electrical/mechanical service technicians. Lethal voltages are present and exposed in the power supply and display.

Note

*The sensor **MUST** have zero differential between the Test port and Reference port. For Gauge Calibrators, apply atmospheric pressure to the Reference port. For Absolute Calibrators, apply a vacuum to the Reference port (<200 μHg.)*

1. Remove the RUSKA 7250's top cover.
2. Locate and remove the plastic zeroing plug located on the side of the sensor oven assembly.

3. Enter the Zeroing screen by selecting MENU | CALIBRATE.
4. Select the Primary sensor by pressing the Sensor [F6] key until the word Primary is displayed above the calibration coefficients.
5. Select Zero [F1]. Do NOT press the Calibrate button.
6. Select the Mechanical Zero [F1] key.



Figure 6-6. Photocell Zeroing Menu

gkn045.bmp

7. Refer to Figure 6-9, slightly loosen the Allen screw on the back of the sensor bracket, making sure to maintain a snug fit on the screw. Using the T-shaped Photocell Centering Tool (part number 7250-111), adjust the photocells by placing the tool in the hole in the back of the sensor and turning the tool slightly. The screen will show a number of horizontal lines. The top yellow bar represents the current zero setting. The bottom portion of the bar has a green bar in the center and two red bars on either end. If the top yellow bar is over the red bar, then mechanical zeroing is required. If the yellow bar is over the green bar, then no adjustment is required.

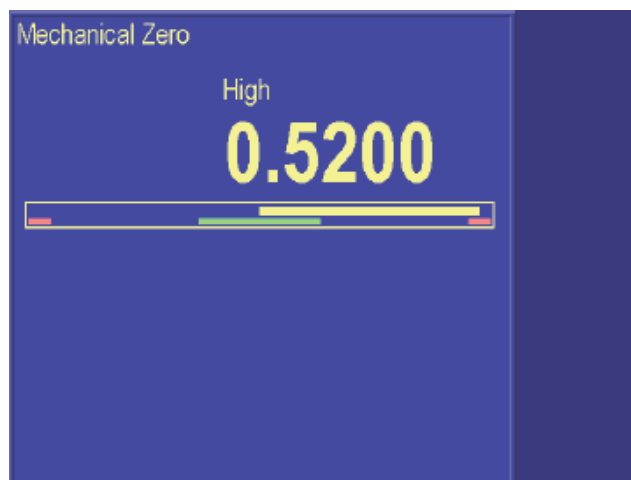

Figure 6-7. Centering the Photocell

gkn046.bmp

8. Adjusting the photocell will cause the yellow bar to reduce in width. You want to adjust the photocell until the yellow line is as thin as possible over the green bar.



gkn047.bmp

Figure 6-8. Correct Adjustment of Photocell Centering Bar

9. Tighten the Allen screw.
10. Often, when the Allen screw is tightened, the zero will move. Review the width of the yellow line, again loosen the Allen screw, and now offset the yellow bar the same width that you observed it moving from tightening the Allen screw, and now offset it in the opposite direction by this same width.
11. Again, tighten the Allen screw. Now the width of the yellow line should be minimized.
12. Tap on the bracket with a screwdriver handle to relieve mechanical stress. Continue to tap on the bracket until the counts stop changing.
13. If the zero moved significantly as a result from tapping the bracket, repeat this procedure as necessary.
14. Reinstall plastic zeroing plug.
15. After the unit has become thermally stabilized, perform a normal instrument zeroing procedure. See Chapter 6, Editing The Calibration Coefficients.

Mechanical Zero of the RUSKA 7250xi

On a RUSKA 7250xi, the mechanical zeroing procedure is the same as with the 7250 and 7250i except there will be two devices that will require the mechanical zeroing. On the mechanical zeroing screen shown above, there will be two horizontal bar graphs, one labeled high and the other labeled low. There is one bar for each sensor assemblies. Inside the RUSKA 7250xi, facing the front of the instrument, the High sensor assembly is located on the right hand side next to the power supply. The Low assembly is located on the left hand side next to the multiple electronic plug-in cards. You will need to assure that both sensor assemblies are mechanically zeroed per the above procedure.

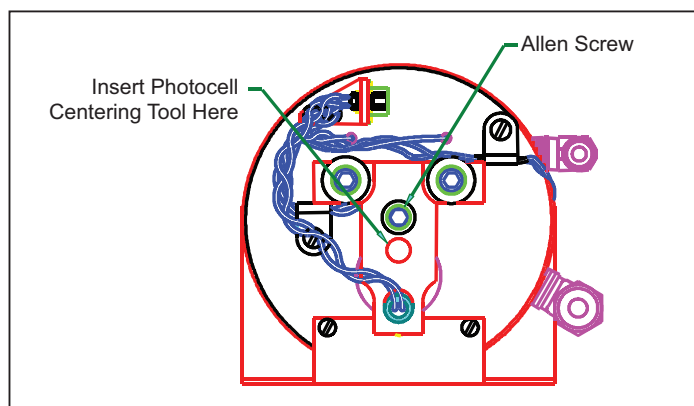

gkn048.eps

Figure 6-9. Photocell Location

Optimizing Control

The performance of the controller may be optimized for certain environments or performance criteria by adjusting the values available in the Control screen. The Control screen is available from the Main Menu by pressing Menu [F6] | Test [F5] | Control [F6]. The Control screen is shown below.



Figure 6-10. Menu | Test | Control - Menu

gkn050.bmp

Note

Be sure the Control Band parameter is set to zero (Chapter 4, Menu, Menu Setup, Menu Setup Limits, Auto Vent).

If the controller does not control optimally, it would be recommended to first assure that the system is free of leaks and is operating within the external volume specifications (see Appendix A). You should verify that the instrument is fitted with the proper sized pressure lines to minimize flow restrictions (see Chapter 3, Pneumatic Connections). Verify that the control band is set as intended (see Chapter 4, Menu, Menu Setup, Menu Setup Limits, Auto Vent). For active control, when testing the controller the Control Band Off and Control Band On values should be set to zero. Finally verify that the control is set to Normal to minimum overshoot (see Chapter 4, Menu, Menu Setup, Menu Setup Limits, Control Band). If the system continues to control improperly, you can perform the Auto-tune.

There are two options available to the operator.

Full—this fully characterizes the control function of the RUSKA 7250. It automatically adjusts the control valve biases and aligns the inner loop high control pressure sensor to the high accuracy quartz sensor. This should be performed any time major components are replaced in the controller such as the control valves or the high-speed inner loop control sensor. Additionally, if the controller is not functioning properly, a full Auto-tune can be performed to optimize the control.

Calibrate—this automatically aligns the inner loop high control pressure sensor to the high accuracy quartz sensor. If in the Normal control mode (as opposed to the fast control mode), the controller overshoots the commanded pressure valve, this could be an indication that the inner loop control sensor needs to be realigned with the high accuracy quartz sensor. This is achieved by running the Calibrate Auto-Tune function.

Note

Prior to performing any Auto-Tune functions in an effort to improve the controller performance, confirm that the system is a leak free system and the volume attached to the test port is within the recommended range (see Appendix A). Additionally, assure that the system has adequate pressure and vacuum supply (when required).

To perform these Auto-Tune functions, the instrument must be connected to a pressure supply with the pressure supply set to the proper supply pressure (Refer to the specifications in Appendix A). On absolute instruments, a vacuum pump must be connected to the exhaust port.

Disconnect any device under test from the test port. The test port must be connected to a sealed volume of 5 to 15 cubic inches (80 to 240 cc).

Use the Rotary knob to select which Auto-Tune procedure is to be performed and then press the Enter key. Full performs the complete Auto-Tune sequence. If selected, you are not required to run any of the other Auto-Tune functions. Press the Enter key.

The Calibrator will go through a sequence of controlling to various pressures and automatically adjusting the control parameters of the valves. The Calibrator will display a message indicating when it is complete with the Auto-Tune procedure. The time required to complete the Auto-tune procedure can range anywhere from 1 to 3 hours.

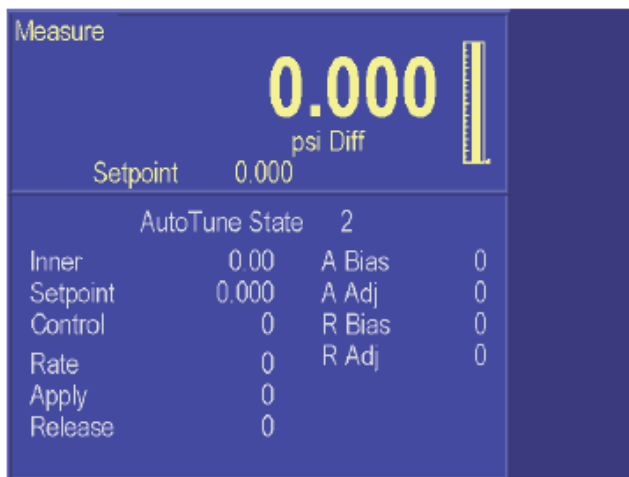

Figure 6-11. Auto-Tune Menu

gkn051.bmp

If any control valves or the high speed inner loop pressure sensor has been replaced, the Auto-Tune should be run to characterize the new hardware.

Fan Operation

The fan in the RUSKA 7250 can be turned on or off. It is recommended to keep the fan ON since this will extend the life of the power supply.

When operating the system in either a very cold or hot environment, if the oven is unable to maintain the temperature of the internal oven, it will generate error Oven Control Failure Error messages. The operator can review the temperature and duty cycle of the oven by pressing the MENU | DISPLAY keys. The unit must have been warmed up for a minimum of 2 hours prior to determining the condition of the oven temperature control. The temperature of the sensor should be controlled to 50 °C. The Duty cycle indicates the percentage of time that the oven control is turned on in order to maintain the oven at the proper set-point of 50 °C. A unit that is operating properly, after it has fully warmed up,

should indicate a sensor temperature of 50 °C and a duty cycle between 10 to 90%.

If operating the instrument in a very cold environment and the oven duty cycle is at a high percentage (>90%) you will need to turn the fan off. If you are operating in a warm environment or when multiple systems are housed in consoles without adequate ventilation, the system may become too hot and generate the oven control failure error message. If operating the instrument in a warm environment and the oven duty cycle is at a low percentage (>10%) you will need to turn the fan on.

When the operator changes the status of the fan, it will default to that condition until it is changed by the operator.

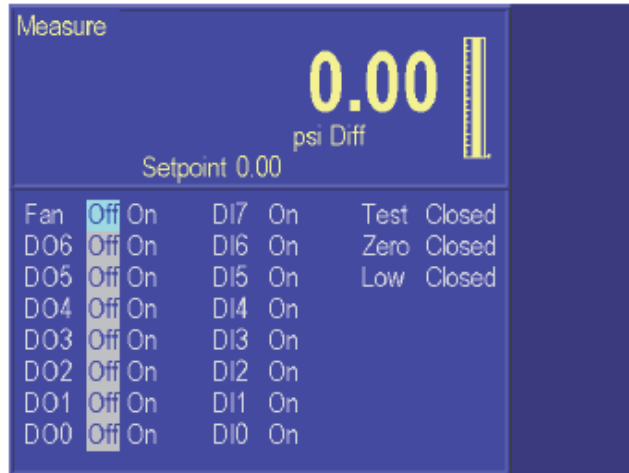

Figure 6-12. Menu | Test | Shop 1 - Menu

gkn052.bmp

To turn the fan on or off, press Menu [F6] from Main Menu | Test [F5] | Shop1 [F5]. Use the rotary knob to highlight either fan Off or On. Press ENTER to select.

System Software Update Procedure

Note

Calibration and other stored constants are not affected by program updates.

The update procedure requires a PC connected to the RS-232 port on the 7XXX. (9-pin to 9-pin, null modem cable minimum pinout 2-3, 3-2, 5-5).

1. When appropriate, RUSKA can e-mail the latest version of the software for upgrading instruments. The e-mail will have a zip file attached contains two files UPDATE7.EXE and <version>.IMG. Unzip these files into a directory on the PC.
2. Set the 7XXX to 9600 baud, 8 databits, no parity, 1 stopbit.
3. Run the program Update7.
4. Follow the prompts to select the communications port and the image file.
5. When the upgrade is finished, Update7 running on the PC and the 7XXX should both display Complete.

RUSKA 7250 Controller Software Upgrade

In addition to the main code, the RUSKA 7250 includes code for the pressure controller. The controller software version can be viewed by pressing the MENU | TEST | REMOTE | SERIAL2 keys. The controller software version is displayed next to “Ctrl”. This code can be upgraded through the RS-232 port on most units. Press the MENU | TEST | CONTROL key and check for “Download Yes”.

If “Download...No” is displayed then the chip must be replaced to upgrade software. If “Download” is not displayed upgrade the main software to 7250-1R17 or higher first.

(The digit in front of the R increases with revision levels and the last two digits will increment upwards as the revision level increases, e.g. 0R99 is older code than 1R01 which is older than 1R08, etc.)

1. Connect a PC to the RS-232 port on the 7XXX using a null modem cable.
2. The zip file labeled 7250 Control|XRXX contains files UPDATE7.EXE and <version>.IMG. Unzip these files into a directory.
3. Set the 7XXX to 9600 baud, 8 databits, no parity, 1 stopbit.
4. Run the program Update7.
5. Follow the prompts to select the communications port and the image file.
6. Update 7 should display Complete.

Note

When updating the controller code, the RUSKA 7250 will display various error messages. This is expected. The front display will freeze on the RUSKA 7250 when the controller code is being downloaded. It will operate properly once the download is complete. Finally, the main software only reads the software versions on power-up. So, following the controller code upgrade, pressing the Menu | Test | Remote | Serial2 keys will only show the new revision level of the controller code after power is cycled on the RUSKA 7250.

Replacement Parts

The following is a list of the common replacement parts used in the RUSKA 7250.

Table 6-2. RUSKA 7250 Parts

	Low Pressure Manifold				High Pressure Manifold	
	Maximum Full Scale Pressure 1 psi to 175 psi (6.9 kPa to 1206 kPa)		Maximum Full Scale Pressure 175 psi to 1016 psi (1206 kPa to 7005 kPa)		Maximum Full Scale Pressure 1016 psi to 3000 psi (7.0 MPa to 20.7 MPa)	
Part Name	Valve Body	Valve Coil	Valve Body	Valve Coil	Valve Body	Valve Coil
Supply Pressure	3915771	3915780	3915771	3915800	3915649	3915651
Exhaust Pressure	3915771	3915780	3915771	3915800	3915649	3915651
Test Port	3961365	3915780	3961365	3915780	-	-
Reference Port	3961365	3915780	3961365	3915780	3878948	3915651

Table 6-3. RUSKA 7250 Additional Parts

Part Number	Description
3878948	7250xi isolation manifold valve body
3915651	7250xi isolation manifold valve coil
3879016	Display Upgrade Kit
3876760	Sensor LED Lamp Assembly
3908093	Sensor Photocell
3878975	Photocell Adjustment Tool
3865784	Power Supply
3962098	Fan
3878927	Rotary Encoder
3878543	Front Panel Keyboard Electronic Card

Cleaning

When necessary, clean externally using a damp lint free cloth and mild liquid detergent.

Chapter 7

Preparation for Storage & Shipping

Introduction

⚠ Caution

The procedures given in this Chapter must be strictly adhered to in order to prevent damage to the instrument. Failure to follow these procedures will likely result in damage to the RUSKA 7250 during shipment. This damage is not covered by the carrier's insurance.

Disconnecting the RUSKA 7250

1. Relieve all pneumatic pressure from the Calibrator.
2. Turn the Calibrator power switch to the Off position.
3. Disconnect the power cable from the Calibrator power receptacle.
4. Disconnect all pneumatic lines and fittings from the RUSKA 7250's back panel.
5. Plug all ports.

Packing Instructions

To prevent shipping and handling damage to the instrument, adhere to and strictly follow the instructions below.

The governing discipline in ensuring a damage-free shipment is to ensure that the possibility of handling shocks to the RUSKA 7250 is minimized and/or prevented during transit. Fluke accomplishes this task by cradling the Calibrator within two foam cradles that are encapsulated within a double-walled, corrugated box. The Calibrator is restrained and supported, but still has resilience. The materials used in the packaging operation are foams that have a minimum impact rating of not less than N-95.

⚠ Caution

Styrofoam, poured "foam in place" mixtures, and other rigid foams are not recommended.

If polyfoam or rubber foam other than that used in the original packaging is to be used, cut it into strips so that it will not present a large rigid surface to the Calibrator.

Fluke has found that corrugated cardboard boxes provide the best packaging exterior. The box must have an impact rating of 275 lb and be of double-walled construction. This type of box will sustain most types of damages incurred during the shipping and handling process, but ensures that the contents remain intact and damage-free. The foam cradle ensures that a minimum of 3 inches (7.6 cm) of foam separates the inner surface of the box and any portion of the Calibrator.

⚠ Caution

Wood or metal boxes do not absorb shock when dropped and; therefore, are not recommended.

If the original packaging and shipping materials have been retained, use them for packing the RUSKA 7250. If the Calibrator is being packed for long-term storage (more than 30 days), place a desiccant bag inside the box.

The RUSKA 7250 must be prepared for shipment in the following manner:

1. Fluke Calibration has an RMA procedure in place. Please contact the Customer Service Center to obtain an RMA number prior to returning any equipment to Fluke. Have the following information available when contacting Fluke:
 - the part number,
 - the serial number,
 - the purchase order number,
 - the billing and ship to address, and
 - the buyer's name and telephone number.

This information plus the RMA number must be attached to the unit when it is shipped to Fluke Calibration Instrument. There will be a minimal charge for inspection and/or evaluation of returned goods.

2. Enclose the Calibrator in plastic or any good water barrier material. Antistatic material is recommended.
3. If the original shipping carton is not usable or available, use a double-walled corrugated carton with a 275-lb rating. The recommended carton size is 25 1/2 x 19 1/2 x 12 3/8 inches (64.8 x 49.5 x 31.4 cm).
4. Insert one foam cradle from the original shipment onto the floor of the box. (The original foam cradles are of the same type of construction and are completely interchangeable.) If the foam cradles are not available, cover the bottom and sides with no less than 3 inches (7.6 cm) of N-95 foam strips. Arrange the strips in the configuration illustrated in Figure 7-1.
5. Before sealing the carton, include the following:
 - Statement of the problem or service needed. Be specific. Include the name and telephone number of a knowledgeable technician for consultation.
 - The part number, serial number, return address, and purchase order number.
6. Seal the carton using gummed tape.
7. Address the carton as specified on the RMA paperwork.

- Label the carton with the following labels: **THIS SIDE UP, HANDLE WITH CARE, DO NOT DROP, and FRAGILE.** (If the original Fluke shipping carton is utilized for this shipment, the above markings are preprinted on the carton.)

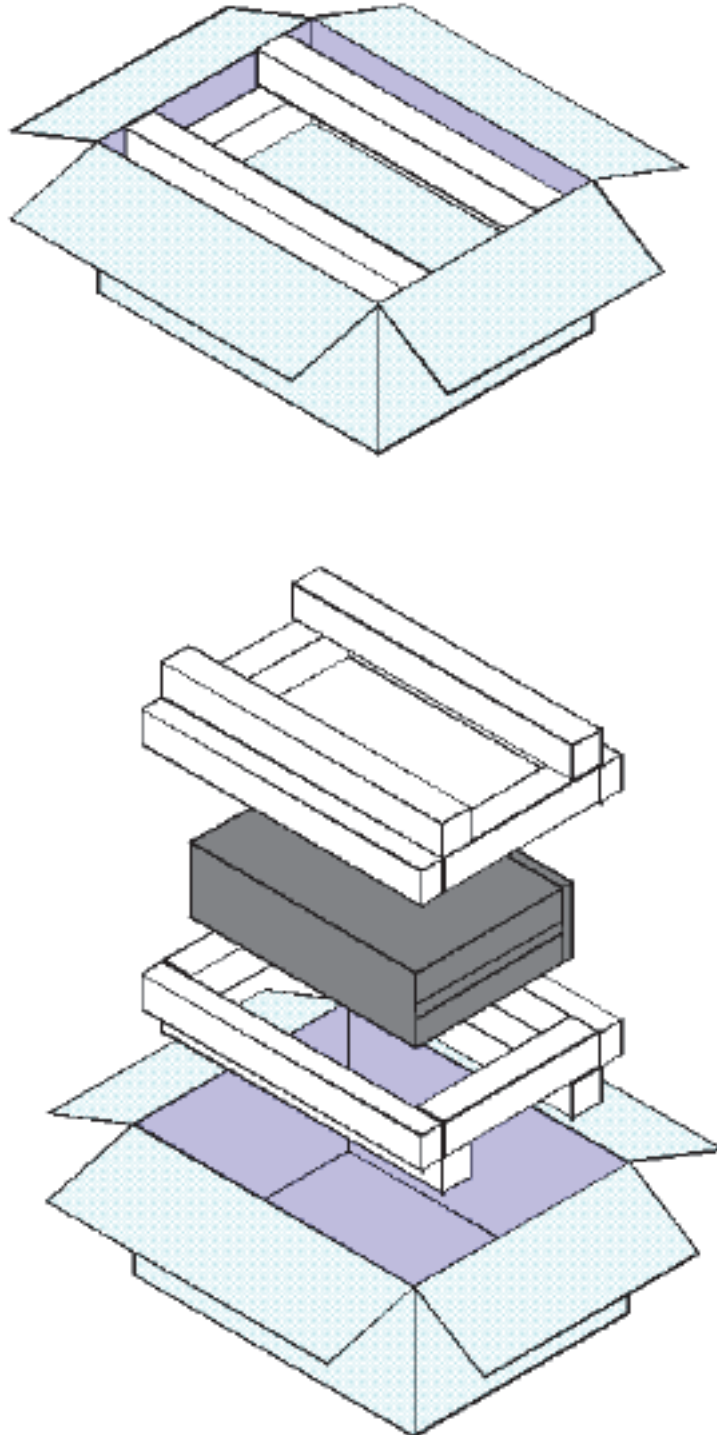

Figure 7-1. Packing the RUSKA 7250

gkn049.bmp

Shipping Instructions

Fluke recommends using air freight for transportation. Surface transportation subjects the shipment to more frequent handling and much more intense shock. In most cases, if surface transportation is the mode of transport employed, handling damage is likely.

Again, it is essential that the procedures mentioned in this Chapter be strictly adhered to in order to prevent any shipping and handling damage to the instrument.

Appendix A

Summary of Specifications

Uncertainty Analysis

To perform an Uncertainty Analysis on a measurement device, you must be able to identify all of the parameters that influence the measurement. You must be able to quantify the magnitude of the potential error source and combine these into an overall uncertainty statement.

To determine the expanded uncertainty on any manufacturers pressure Transfer Standard (TS), you must identify the following four primary influences;

1. Performance specifications of the TS
2. Long term Stability of TS
3. Uncertainty of the standard used to calibrate the TS
4. Environmental or installation influences that could cause errors in the TS

Performance Specifications

Performance specifications are the short-term measurement properties of the device. These traditionally include linearity, hysteresis, and repeatability properties of the transfer standard. There often is considerable confusion with the performance specification because different manufacturers use different terms to describe the performance characteristics of their instruments. The two most common terms used are “Accuracy” and “Precision”. In both cases, as a minimum the manufacturers define these terms to be the combined effects of linearity, hysteresis and repeatability. Since the manufacturer defined the terms they used, this should not be a problem. However, it is common that the users definition of these terms differ from the manufacturers and therefore cause considerable confusion. For instance, the user may believe that the term “Accuracy” includes all sources of uncertainty. This would include items 1 through 4 listed above which would be an all encompassing specification. The manufacturer may define “Accuracy” as the performance specification which consist only of item 1 above. The result would be that the instrument would not be capable of meeting the users application because it would not meet the users definition of “Accuracy”.

Long Term Stability

Long term stability defines how the instrument drifts with time. This specification can be utilized to define the calibration interval for the standard. Some manufacturers will provide more than one stability specification for their instrument based on different calibration time intervals. It is important to understand that you should not arbitrarily vary the manufacturers stability specification based on time without knowing the characteristics of their device. Some manufacturers identify that their stability specification is proportional with time. Therefore, if the calibration interval were reduced in half, the magnitude of the stability specification would also be halved. This can be a powerful tool when you are trying to improve the measurement performance of a standard. By reducing the calibration interval, the expanded uncertainty would also reduce. On the other hand, some manufacturers do not claim that their stability specification is proportional with time. This would be the case for instance if the instrument naturally drifted in a sinusoidal fashion. This would suggest that the sensor could drift to its maximum stability limit at any time and therefore, reducing the calibration interval would not improve the expanded uncertainty of the device.

Short Term Stability

Short Term Stability relates to the zero drift characteristics of the instrument. This generally is classified as short term drift since the instrument can be re-zeroed without performing a full calibration as required to correct for long term span drifts. The magnitude of zero drift can be assessed based on the length of time between re-zeroing the instrument.

Uncertainty of the Standard

Uncertainty of the Standard used to calibrate the transfer standard. This is the expanded uncertainty of the calibration standard that was used by the manufacturer to calibrate the digital transfer standard. This should be the expanded uncertainty of the calibration standard and include all sources of uncertainty that would influence the calibration standard including the uncertainty from the National Standards Laboratory that the standard is traceable.

It should also be noted that when the instrument is re-calibrated, the uncertainty of the device is influenced by the uncertainty of the calibration standard that will be used to perform the re-calibration. Therefore, the uncertainty analysis should be evaluated following each re-calibration. If the instrument is re-calibrated using a different calibration service provider than the manufacturer, the uncertainty of the standard that the calibration service provider used to perform the calibration would need to be substituted for the manufacturers calibration uncertainty that was used in the original uncertainty analysis.

Environmental or Installation Influences

Environmental or Installation Influences that could cause errors in the transfer standard includes influences such as ambient temperature, line pressure, head pressure, time response, and controller effects. (It may include other influences that are very specific to one manufacturers instrument.) It is recommended that the intended application is reviewed to assure that the environmental does not impact the instruments performance, or that the impact from the environment is accounted for in the uncertainty analysis. For instance, if an instrument has a 0.001%FS per degree Celsius temperature effect from a calibrated temperature of 20 degrees Celsius, and the instrument is to be used in an environment where the temperature will vary from 15 to 25 degree Celsius, then a +/- 0.005% of full scale uncertainty should be included in the uncertainty analysis for ambient temperature effects.

Combining the Uncertainty Components

Combining the Uncertainty Components into an Expanded Uncertainty Statement means that once all of the uncertainty components are identified, they can be combined into an overall Expanded Uncertainty Statement for the instrument. The vast majority of the measurement community has adopted a statistical approach to uncertainty analysis such as the International Organization for Standards (ISO) Guide to the Expression of Uncertainty in Measurement. This statistical approach combines all of the uncertainty components in quadrature (RSS).

In this approach, it is important to define the level of confidence that all of the uncertainty components are defined. For instance, all of the uncertainty specifications that Fluke Calibration publishes are at the 2 sigma level which would be at a 95% confidence level. Some manufacturers may state their uncertainty at different confidence level and therefore, you would need to be able to convert from one to the other in order to compare the two devices. For instance, if a manufacturer states that they have an uncertainty of 0.005% FS and that the uncertainty is expressed at the 1 sigma level, then it would be doubled to express it at the 2 sigma level (i.e. it would be an 0.01% FS device at a 2 sigma or 95% confidence level.)

Absolute Mode

A Barometric Reference Sensor option is available on the RUSKA 7250xi to allow it to operate in the Absolute mode. With the RUSKA 7250 and 7250i there are 2 options available that allow a instrument to operate in the absolute mode. These are by adding a Barometric Reference Sensor to the system to monitor the barometric pressure and add this value to the gauge reference quartz sensor. Or the second is to evacuate the reference port of the RUSKA quartz sensor and then monitor the residual vacuum in the reference port and correcting for this residual vacuum.

In either case, the expanded uncertainty of the system must account for the potential uncertainty of whichever sensor is used in the system to allow it to operate in the absolute mode. Therefore, the uncertainty of one of these sensors would be combined RSS (Root Sum Squared) with the expanded uncertainty of the system.

Barometric Reference Sensor—Option

The two sigma expanded uncertainty of the barometric reference sensor is estimated to be less than or equal to 0.002 psi (13.8 Pa) per year. This uncertainty component should be combined RSS with the primary sensor uncertainty when operating in the absolute mode with a barometric reference sensor.

Evacuated Reference—Option

The two sigma expanded uncertainty of the vacuum sensor used to monitor the reference pressure is estimated to be the greater of 10% or reading or 10 mtorr (1.33 Pa) per year. Therefore, it operates at its optimal performance when the vacuum level is less than 100 mtorr. This uncertainty component should be combined RSS with the primary sensor uncertainty when operating in the absolute mode with an evacuated reference vacuum sensor.

Controller Specification

When the system is in control mode, the control noise is defined as how close the controller can maintain the control pressure to the commanded set-point. In the active control mode, the RUSKA 7250 has a control noise specification of 0.001% of Full Scale.

In the Passive control mode, since the controller shuts off when it reaches a user-defined band about the commanded set-point, the uncertainty of the pressure measurement is not influenced by the controller.

The following two tables are uncertainty analysis examples for a RUSKA 7250xi based on a three month and a yearly calibration.

Table A-1. Uncertainty Analysis for RUSKA 7250xi—Three Month Analysis

Uncertainty Analysis – <u>3 Month</u> Calibration Interval RUSKA 7250xi from 25 to 100% of Range	Uncertainty (2 sigma)
A. Performance – (Linearity, Hysteresis, Repeatability and Temperature)	0.005% of Reading
B. Stability – (3 months)	0.0019% of Reading per 90 days
C. Calibration Standard – (RUSKA Model 2465 DWG)	0.0010% of Reading
D. Environmental –	
Temperature (Included in A. above)	0.000% of Reading
Head Pressure	0.001% of Reading
Control – (in Passive Control Mode)	0.000% of Reading
2 sigma Expanded Uncertainty (RSS)	0.0055% of Reading per 90 days

Table A-2. Uncertainty Analysis for RUSKA 7250xi—One Year Analysis

Uncertainty Analysis – <u>One Year</u> Calibration Interval RUSKA 7250xi from 5 to 100% of Range	Uncertainty (2 sigma)
A. Performance – (Linearity, Hysteresis, Repeatability and Temperature)	0.005% of Reading
B. Stability – (1 year)	0.0075% of Reading / year
C. Calibration Standard – (RUSKA Model 2465 DWG)	0.0010% of Reading
D. Environmental –	
Temperature (Included in A. above)	0.000% of Reading
Head Pressure	0.001% of Reading
Control – (in Passive Control Mode)	0.000% of Reading
2 sigma Expanded Uncertainty (RSS)	0.009% of Reading per year

The following two tables are uncertainty analysis examples for a single range RUSKA 7250 based on a three month and a yearly calibration.

Table A-3. Uncertainty Analysis for RUSKA 7250—Three Month Analysis

Uncertainty Analysis – <u>3 Month</u> Calibration Interval RUSKA Model 7250	Uncertainty (2 sigma)
A. Performance – (Linearity, Hysteresis, Repeatability and Temperature)	0.003% of Full Scale
B. Stability – (3 months)	0.0019% of Reading per 90 days
C. Calibration Standard – (RUSKA Model 2465 DWG)	0.0010% of Reading
D. Environmental –	
Temperature (Included in A. above)	0.000% of Reading
Head Pressure	0.001% of Reading
Control – (in Active Control Mode)	0.001% of Full Scale
2 sigma Expanded Uncertainty (RSS)	0.0032% of Full Scale RSS with 0.0024% of Reading per 3 months

Table A-4. Uncertainty Analysis for RUSKA 7250—One Year Analysis

Uncertainty Analysis – <u>One Year</u> Calibration Interval RUSKA 7250	Uncertainty (2 sigma)
A. Performance – (Linearity, Hysteresis, Repeatability and Temperature)	0.003% of Full Scale
B. Stability – (1 year)	0.0075% of Reading / year
C. Calibration Standard – (RUSKA Model 2465 DWG)	0.0010% of Reading
D. Environmental –	
Temperature (Included in A. above)	0.000% of Reading
Head Pressure	0.001% of Reading
Control – (in Active Control Mode)	0.001% of Full Scale
2 sigma Expanded Uncertainty (RSS)	0.0032% of Full Scale RSS with 0.0076% of Reading per year

Specifications

General Specifications

Pressure Range:	Minimum; 0 to 5 (0 to 700 mbar) Maximum; 0 to 3000 psi (0 to 200 bar)
Display:	6.4 inch, TFT Active Matrix Color
Display Resolution:	User-selectable up to 1:1,000,000
Electrical Power:	100-240 VAC, 50/60 Hz single phase, 150 VA
Operating Temperature:	18–36 °C
Storage Temperature:	–20–70 °C
Humidity:	5–95% relative humidity, non-condensing
Nominal Control Volume:	5–60 in ³ (80–1000 cc's)
Dimensions:	7" H x 16.5" W x 19" D (17.8 cm x 41.9 cm x 48.3 cm)
Weight:	RUSKA 7250 & 7250i: 17 lb (7.7 kg) RUSKA 7250xi: 20 lb (9 kg)
Standard Pressure Units:	inHg at 0 °C and 60 °F, kPa, bar, psi, inH ₂ O at 4 °C, 20, and 25 °C, kg/cm ² , mmHg at 0 °C, cmHg at 0 °C, and cmH ₂ O at 4 °C
Pneumatic Ports:	1/4-inch NPT female
Relief Valves:	Test Port: 120% of Maximum Scaled Quartz Sensor Range Reference: 10 Psig (where applicable)
Supply Pressure:	115% FS for units greater than 100 psi 100% FS plus 15 psi for units less than or equal to 100 psi
Ingress Protection:	IP 20, indoor use, altitude <2000m
EMC:	EN 61326
Electrical Safety:	EN 61010-1, pollution degree 2
Pressure Safety:	Pressure Equipment Directive 97/23/EC - Article 3.3, Sound Engineering Practice (SEP)
Interface:	IEEE-488, RS232

Performance

Table A-5. Performance Specifications: RUSKA 7250

Pressure Range	5–1000 psi (0.34–68.9 bar)	1000–2500 psi (68.9–172 bar)	15–50 psi (1–3.45 bar)	3000 psi (210 bar)
Mode	Gauge	Gauge	Absolute	Gauge
Precision ²	0.003% FS	0.003% FS	0.003% FS	0.01% FS
Stability Over 3 Months: Over 1 Year:	0.0019% RDG/ 3 months 0.0075% RDG/year			0.01% FS
Zero Drift ⁴	<0.004%FS / 24hrs	<0.004%FS / 24hrs	<0.004%FS / 24hrs	<0.004%FS / 24hrs
Control Stability	0.001% FS	0.001% FS	0.001% FS	0.001% FS
Control Low Limits ³	0 psig 0.15 psia	0 psig 0.15 psia	0.15 psia	0 psig 0.15 psia
Slew Rate ⁵	<20 Seconds	<20 Seconds	<20 Seconds	<60 Seconds
Test Port Isolation	Standard	none	standard	none

Table A-6. Performance Specifications: RUSKA 7250LP

Pressure Range	10/30, 20/60 & 35/100 inH2O (25/75, 50/150, & 85/250 mbar)
Mode	Gauge
Precision ²	From 10% to 100% Max FS: 0.005% of Reading, Below 10% Max FS: 0.005% of 10% Max FS
Stability Over 3 Months: Over 1 Year:	0.0019% RDG/ 3 months 0.0075% RDG/year
Zero Drift ⁴	<0.006% Max FS / 24hrs
Control Stability	0.004% of Range
Control Low Limits ³	0 psig (-30in H2O w/option and external Vac. Pump)
Slew Rate ⁵	<20 Seconds

Table A-7. Performance Specifications: RUSKA 7250i and 7250xi

MODEL	RUSKA 7250i	RUSKA 7250xi
MODE	GAUGE	GAUGE
Precision ¹	From 25% to 100% FS: 0.005% RDG Below 25%FS: 0.005% of 25%FS	From 5% to 100%FS: 0.005% RDG Below 5%FS: 0.005% of 5%FS
Neg. Gauge Precision (opt.)	Greater of 0.005% of 25%FS or 0.0075 psi (0.05 kPa)	Greater of 0.005% of 5%FS or 0.00075 psi (0.005 kPa)
Stability Over 3 Months: Over 1 Year:	0.0019% RDG/ 3 months 0.0075% RDG/year	0.0019% RDG/ 3 months 0.0075% RDG/year
Zero Drift ²	<0.002%FS / 24hrs	<0.001%FS / 24hrs
Control Stability	0.001% of maximum FS	0.001% of maximum FS
Control Low Limit ³	0 psig 0.15 psia	0 psig 0.15 psia
Slew Rate ⁴	<20 Seconds	<20 Seconds
Test Port Isolation	standard	standard up to 1000 psi (6.89 MPa) full scale ranges

¹Precision is defined as the combined effect of linearity, repeatability, and hysteresis throughout the operating temperature range. Some manufacturers use the word “Accuracy” in place of “Precision”, however the meaning is identical.

² Zero drift typically improves with sensor age.

³ Requires vacuum pump to control 0 psig, or the vent mode can be used to obtain 0 psig.

⁴ Defined as 10% FS increments into a 15 cubic inch volume.

Gas Specifications

Pressure Source Medium:	Clean Dry Air or Nitrogen*
Pressure Source Particle Size Contamination:	≤50 microns
Pressure Source Max. Moisture Content:	-50 °C dew point
Pressure Source Max. Hydrocarbon Content:	30 ppm

* Industrial grade nitrogen, 99.5% pure

Vacuum Requirements

Supply Vacuum:	50 liters per minute (minimum) with auto vent feature
(absolute units only)	Bypass Supply Vacuum Valve for High Pressure Gauge work

Appendix B

Summary of Error Messages

Summary of Error Messages

Negative error numbers are from the Standard Commands for Programmable Instruments (Version 1991.0).

Table B-1. Summary of Error Messages

Value	Description and Corrective Action
0	No Error.
-103	Invalid Separator. Check punctuation in the SCPI command.
-104	Data Type. The type of parameter data is incorrect.
-109	Missing Parameter. No valid parameter was found for the SCPI command.
-110	Command Header. The command name is not valid.
-113	Command Unknown. The command specified does not exist.
-114	Header Suffix. The numeric suffix for the command name is out of range.
-221	Settings Conflict. The command could not be executed due to the current state of the Calibrator. Some commands cannot be executed while a program, self-test, or calibration is in progress.
-222	Out of Range. The value is not within the valid range. For pressures check high and low limits.
-281	Cannot create program. Program memory is full.
-282	Illegal Program Name. The name specified is not valid or does not exist.
-284	Program Currently Running. The command cannot be executed while a program is running.
-285	Program Syntax Error. The syntax of the program definition is not correct.
-286	Program Runtime Error. An error occurred while running the program. Usually the set-point is out of range.
-313	Calibration Data Lost. The calibration data has been lost and the unit must be recalibrated.

Summary of Error Messages, cont.

-315	Configuration Data Lost. The configuration data has been lost. Check all parameters to be sure they are correct.
-330	Self-Test Failed. Check the display for the test that failed.
-350	Queue Overflow. The error queue was full and messages were lost.
-400	Query Error. A read request was received when there was nothing to read.
500	Controller Malfunction. Internal control failure.
501	High Limit Exceeded. The pressure was greater than the high limit.
502	Low Limit Exceeded. The pressure was less than the low limit.
503	Slew limit Exceeded. The pressure changed faster than the slew limit allowed.
521	Pressure Overrange. The pressure reading is outside the range of the Calibrator.
531	Oven Temp Overrange. Either the transistor that drives the heater for the quartz Bourdon tube sensor (Chapter 2) or the oven temperature sensor itself is malfunctioning. To observe the oven temperature, select OK then select MENU/DISP. Check the transistor and sensor for malfunction, requesting service (Chapter 7) if necessary.
533	Case Pressure Overrange. Select OK, then reduce the pressure at the case reference port to 30 psia or lower.
540	Mechanical Zeroing Needed. The zero point of the quartz Bourdon sensor is beyond the range of the compensation circuit. The zero is adjusted by the software but should be manually adjusted for complete accuracy.
542	Oven Control Failure. The temperature controller is unable to keep the sensor at the proper temperature.
545	Sensor Communication Error. Unable to Communicate with RUSKA 7215xi Sensor
546	Sensor Calibration Lost. The RUSKA 7215xi sensor has lost its calibration and must be recalibrated.
600	Factory Data Lost. Internal factory constants have been lost. Contact Fluke for more information.
601	Calibration Mode. The Calibrate button must be pressed before SCPI calibration commands can be executed.
800	Solenoid Over-Temperature. The control solenoids have over-heated. Wait until they have cooled before entering Control mode.
801	Error reading Barometric RPT Pressure Sensor
802	Control Sensor out of range
803	Controller Communication Error
804	Autotune Failed